

# Panasonic®

## Installation Manual

### Hybrid IP-PBX

---



Model No. **KX-NS300**

โพรเฟสชั่นแนล พี. เอ. บี. เอ็กซ์.

30/270 ซอยนวมินทร์ 80 แขวงนวลจันทร์ เขตบึงกุ่ม กรุงเทพฯ 10230

Hotline : 084-920-5065 Tel : 02-519-1718 , 02-107-3057

E.Mail : info@pfpbx.com , jirasak\_service@hotmail.com

www.pfpbx.com

Thank you for purchasing this Panasonic product.

Please read this manual carefully before using this product and save this manual for future use.

In particular, be sure to read "1.1 For Your Safety (Page 14)" before using this product.

**KX-NS300: PFMPR Software File Version 001.00000 or later**

# System Components

## System Components for KX-NS300

Category	Model No.	Description
<b>Main Unit</b>	KX-NS300	Main Unit
<b>Activation Key Codes<sup>*1</sup></b>	KX-NSE101	Activation Key for Mobile Extension for 1 User (1 Mobile User)
	KX-NSE105	Activation Key for Mobile Extension for 5 Users (5 Mobile Users)
	KX-NSE110	Activation Key for Mobile Extension for 10 Users (10 Mobile Users)
	KX-NSE120	Activation Key for Mobile Extension for 20 Users (20 Mobile Users)
	KX-NSM102	2-Channel IP Trunk Activation Key (2 IP Trunk)
	KX-NSM104	4-Channel IP Trunk Activation Key (4 IP Trunk)
	KX-NSM108	8-Channel IP Trunk Activation Key (8 IP Trunk)
	KX-NSM116	16-Channel IP Trunk Activation Key (16 IP Trunk)
	KX-NSM201	1-Channel IP Softphone/IP Proprietary Telephone Activation Key (1 IPSoftphone/IP PT)
	KX-NSM205	5-Channel IP Softphone/IP Proprietary Telephone Activation Key (5 IPSoftphone/IP PT)
	KX-NSM210	10-Channel IP Softphone/IP Proprietary Telephone Activation Key (10 IPSoftphone/IP PT)
	KX-NSM220	20-Channel IP Softphone/IP Proprietary Telephone Activation Key (20 IPSoftphone/IP PT)
	KX-NSM501	1-Channel IP Proprietary Telephone Activation Key (1 IP PT)
	KX-NSM505	5-Channel IP Proprietary Telephone Activation Key (5 IP PT)
	KX-NSM510	10-Channel IP Proprietary Telephone Activation Key (10 IP PT)
	KX-NSM520	20-Channel IP Proprietary Telephone Activation Key (20 IP PT)
	KX-NSM701	1-Channel SIP Extension Activation Key (1 SIP Extension)
	KX-NSM705	5-Channel SIP Extension Activation Key (5 SIP Extension)
KX-NSM710	10-Channel SIP Extension Activation Key (10 SIP Extension)	
KX-NSM720	20-Channel SIP Extension Activation Key (20 SIP Extension)	

Category	Model No.	Description
	KX-NSN002	Activation Key for QSIG Network (QSIG Network)
	KX-NSU002	Activation Key for Two-way Recording Control (Two-way REC Control)
	KX-NSU003	Activation Key for Message Backup (Message Backup)
	KX-NSU102	2-Channel Unified Messaging Activation Key (2 UM Port)
	KX-NSU104	4-Channel Unified Messaging Activation Key (4 UM Port)
	KX-NSU201	Activation Key for Unified Messaging E-mail Notification for 1 User (UM/E-mail 1 User)
	KX-NSU205	Activation Key for Unified Messaging E-mail Notification for 5 Users (UM/E-mail 5 Users)
	KX-NSU210	Activation Key for Unified Messaging E-mail Notification for 10 Users (UM/E-mail 10 Users)
	KX-NSU220	Activation Key for Unified Messaging E-mail Notification for 20 Users (UM/E-mail 20 Users)
	KX-NSU299	Activation Key for Unified Messaging E-mail Notification for All Users (UM/E-mail All Users)
	KX-NSU301	Activation Key for Two-way Recording for 1 User (2way REC 1 User)
	KX-NSU305	Activation Key for Two-way Recording for 5 Users (2way REC 5 Users)
	KX-NSU310	Activation Key for Two-way Recording for 10 Users (2way REC 10 Users)
	KX-NSU320	Activation Key for Two-way Recording for 20 Users (2way REC 20 Users)
	KX-NSU399	Activation Key for Two-way Recording for All Users (2way REC All Users)
	KX-NSA010	Activation Key for CA Thin Client Server Connection (CA Thin Client)
	KX-NSA020	Activation Key for Multiple CSTA Connection (CSTA Multiplexer)
	KX-NSA201	Activation Key for CA PRO for 1 User (CA Pro 1 user)
	KX-NSA205	Activation Key for CA PRO for 5 Users (CA Pro 5 users)
	KX-NSA210	Activation Key for CA PRO for 10 Users (CA Pro 10 users)
	KX-NSA240	Activation Key for CA PRO for 40 Users (CA Pro 40 users)
	KX-NSA249	Activation Key for CA PRO for 128 Users (CA Pro 128 users)

Category	Model No.	Description
	KX-NSA301	Activation Key for CA ACD Monitor for 1 ICD Supervisor (CA Supervisor)
	KX-NSA401	Activation Key for CA Operator Console (CA Console)
	KX-NSA901	Activation Key for CA Network Plug-in for 1 User (CA Network 1 user)
	KX-NSA905	Activation Key for CA Network Plug-in for 5 Users (CA Network 5 users)
	KX-NSA910	Activation Key for CA Network Plug-in for 10 Users (CA Network 10 users)
	KX-NSA940	Activation Key for CA Network Plug-in for 40 Users (CA Network 40 users)
	KX-NSA949	Activation Key for CA Network Plug-in for 128 Users (CA Network 128 users)
	KX-NSF101	Activation Key for CTI interface (CTI interface)
	KX-NSF201	Activation key for Built-in ACD Report, Announcement of waiting number for Queuing (Call Centre Feature Enhancement)
	KX-NSF990	Activation key for VoIP/Unified Message (UM) feature
<b>Physical Cards</b>		
<b>DSP Card Slot</b>	KX-NS5110	VoIP DSP Card (S Type) (DSP S)
<b>SD Memory Cards Slot</b>	KX-NS3134	SD Memory Card (XS Type) (SD XS)
	KX-NS3135	SD Memory Card (S Type) (SD S)
	KX-NS3136	SD Memory Card (M Type) (SD M)
<b>Expansion Master Slot</b>	KX-NS5130	3-Ports Expansion Master Card (EXP-M)
<b>Remote Card Slot</b>	KX-TDA0196	Remote Modem Card (RMT)
<b>Trunk slot</b>	KX-NS5162	Doorphone Interface Card (DPH2)
	KX-NS5180	6-port Analogue Trunk Card (LCOT6)
	KX-NS5290CE	PRI30 / E1 Trunk Card (PRI30/E1)
<b>Extension Slot</b>	KX-NS5170	4-Port Digital Hybrid Extension Card (DHLC4)
	KX-NS5171	8-Port Digital Extension Card (DLC8)
	KX-NS5172	16-port Digital Extension Card (DLC16)
	KX-NS5173	8-Port SLT Card (MCSLC8)
	KX-NS5174	16-Port SLT Card (MCSLC16)

Category	Model No.	Description
Proprietary Equipment	KX-A228	S/M-type Back-up Battery Cable
	KX-A437	19-inch Rack Mounting Adaptor

<sup>1</sup> Note that the types of activation keys are subject to change without notice. For CA activation keys, refer to the documentation for CA.

## System Components for Expansion Unit

Category	Model No.	Description
SPR	KX-NS320	Expansion Unit
Trunk/Doorphone Slot	KX-NS5162	Doorphone Interface Card (DPH2)
	KX-NS5180	6-port Analogue Trunk Card (LCOT6)
	KX-NS5290CE	PRI30 / E1 Trunk Card (PRI30/E1)
Extension Slot	KX-NS5170	4-Port Digital Hybrid Extension Card (DHLC4)
	KX-NS5171	8-Port Digital Extension Card (DLC8)
	KX-NS5172	16-port Digital Extension Card (DLC16)
	KX-NS5173	8-Port SLT Card (MCSLC8)
	KX-NS5174	16-Port SLT Card (MCSLC16)

## Equipment Compatibility for Main Unit KX-NS300

The PBX supports the following equipment:

### Cell Stations

#### DECT

- DECT 2-Channel Cell Stations Unit Using DLC Card for DECT Portable Station (KX-TDA0155CE)
- DECT 8-Channel Cell Stations Unit Using DLC Card for DECT Portable Station (KX-TDA0158CE)
- DECT 8-Channel IP Cell Station Unit Using a V-IPCS4 Card for DECT Portable Station (KX-NCP0158CE)

#### 2.4GHz CS

- 2.4GHz 2-Channel Cell Stations Unit Using DLC Card for 2.4GHz Portable Station (KX-TDA0151)

#### SIP based DECT

- DECT Cell Station Unit (SIP) Using a V-UTEXT8 Card for DECT Portable Station (SIP) (KX-UDS124)

### Doorphones

- Doorphone (KX-T30865, KX-T7765)

### Telephones

#### Panasonic Proprietary Telephones

- IP proprietary telephones (e.g., KX-NT300 series, KX-NT500 series)
- Digital proprietary telephone (e.g., KX-DT300 series, KX-DT500 series, KX-T7600 series)
- Analogue proprietary telephone (e.g., KX-T7700 series)
- DSS Console (e.g., KX-DT390, KX-DT590, KX-T7640)

- IP softphones (e.g., KX-NCS8100)
- Portable stations (e.g., KX-TCA364, KX-WT115)

### SIP Phones

- KX-UT series SIP phones (e.g., KX-UT133, KX-UT248, KX-UT670)
- KX-UDT series portable stations (e.g., KX-UDT111)
- IP conferencing phones (e.g., KX-NT700)
- Third party SIP phones (SIP hardphones/SIP softphones)

### Other

- Single line telephones

### Note

- For the equipment (e.g., Add-on Key Module, USB Module, Headset) that can be connected to a particular telephone, refer to the telephone's manual.
- For other equipment that can be connected to the PBX, refer to "2.1.2 System Connection Diagram".
- The PBX does not support the following Panasonic proprietary telephones:
  - KX-NT136 IP proprietary telephone
  - KX-NT400 IP proprietary telephone
  - KX-HGT100 SIP telephone
  - KX-TDA0300 PC Console
  - KX-TDA0350 PC Phone
  - KX-T7000 series proprietary telephone
  - KX-T7200 series proprietary telephone
  - KX-T7300 series proprietary telephone

### Trunk Adaptors

- E1 Trunk Adaptor (KX-NS8188)
- PRI Adaptor (KX-NS8290)

## Equipment Compatibility for Expansion Unit KX-NS320

You can connect Expansion Unit KX-NS320s to expand the usage of legacy terminals and trunks. If a expansion unit KX-NS320 is connected to a KX-NS300, the following equipment is also supported.

### Cell Stations

#### DECT

- 2-Channel Cell Station Unit Using a DHLC/DLC Card (PT-interface CS) for DECT Portable Station (KX-TDA0155CE)
- 8-Channel High-density Cell Station Unit Using a DHLC/DLC Card (PT-interface CS) for DECT Portable Station (KX-TDA0158CE)

#### 2.4 GHz CS

- 2-Channel Cell Station Unit Using a DHLC/DLC Card (PT-interface CS) for 2.4 GHz Portable Station (KX-TDA0151)

### Telephones

#### Panasonic Proprietary Telephones

- Digital Proprietary Telephone (e.g., KX-DT300 series, KX-DT500 series, and KX-T7600 series)
- Portable Station (e.g., KX-TD7600 series, KX-TCA series)
- DSS Console (e.g., KX-DT390, KX-DT590, KX-T7640)
- Analogue Proprietary Telephone (e.g., KX-T7700 series)

### Note

The following Panasonic proprietary telephones are not available even if an expansion unit is connected:

- KX-TDA0300 PC Console
- KX-TDA0350 PC Phone
- KX-T7000 series proprietary telephone
- KX-T7200 series proprietary telephone
- KX-T7300 series proprietary telephone

### Voice Processing System

Voice Processing System (e.g., KX-TVM series)

## Notice

- This PBX supports SIP extensions. However, some PBX features may not be available depending on the type of telephone.
- Under power failure conditions, the connected telephones may not operate. Please ensure that a separate telephone, not dependent on local power, is available for emergency use.
- Prior to connection of this product, please verify that the intended operating environment is supported. Satisfactory performance cannot be guaranteed for the following:
  - interoperability and compatibility with all devices and systems connected to this product
  - proper operation and compatibility with services provided by telecommunications companies over connected networks

### Note

- Some optional hardware, software, and features are not available in some countries/areas. Please consult your certified Panasonic dealer for more information.
- In this manual, the suffix of each model number (e.g., KX-NS300**BX**) is omitted unless necessary.

## List of Abbreviations

- CA → Communication Assistant
- IP-PT → IP Proprietary Telephone
- PS → Portable Station
- SIP Extension → Extensions of the PBX which use Session Initiation Protocol for communication.
- SLT → Single Line Telephone
- S-PS → SIP-CS compatible Portable Station
- APT → Analogue Proprietary Telephone
- DPT → Digital Proprietary Telephone
- SIP-CS → SIP based DECT Cell Station unit

# Introduction

This Installation Manual is designed to serve as an overall technical reference for the Panasonic IP-PBX, KX-NS300. It provides instructions for installing the hardware, and programming the PBX using Web Maintenance Console. This PBX can also be programmed by using PT. Refer to the PT Programming Manual for more information.

## The Structure of this Manual

This manual contains the following sections:

### Section 1 Safety Precautions

Provides important information intended to prevent personal injury and property damage.

### Section 2 System Outline

Provides general information on the PBX, including the system capacity and specifications.

### Section 3 Information about the Activation Keys

Provides information on activation keys, including how to obtain activation keys.

### Section 4 Installation

Describes the procedures to install the PBX. Detailed instructions for planning the installation site, optional service cards, and cabling of peripheral equipment are provided. Further information on system expansion and peripheral equipment installation is included.

### Section 5 Programming Information

Describes the installation procedure, structure, and functions of the Web Maintenance Console for programming IP telephones and the PBX. Further information on programming the PBX for use with SIP trunks and a VoIP network is included.

### Section 6 Information about Stacking Expansion Unit

Provides information about stacking Expansion Unit.

### Section 7 Troubleshooting

Provides information on the PBX and telephone troubleshooting.

### Section 8 Networking Information

Provides information about topics such as using the PBX in a VoIP network, and the TCP ports used by the PBX.

### Section 9 Appendix

Provides information about PBX Region Suffix Codes and Areas, System Prompt Languages.

## About the Other Manuals

Along with this Installation Manual, the following manuals are available:

### Feature Guide

Describes all basic, optional and programmable features of the PBX.

### PC Programming Manual

Provides step-by-step instructions for performing system programming using a PC.

### PT Programming Manual

Provides step-by-step instructions for performing system programming using a PT.

### User Manual

Provides operating instructions for end users using IP-PTs, SIP phones, SLTs, PSs, or DSS Consoles.

## About the software version of your PBX

The contents of this manual apply to PBXs with a certain software version, as indicated on the cover of this manual. To confirm the software version of your PBX, see "How do I confirm the software version of the PBX or installed cards?" in "2.3 Frequently Asked Questions (FAQ)" of the PC Programming Manual.



## Trademarks

- The Bluetooth® word mark and logos are registered trademarks owned by Bluetooth SIG, Inc., and any use of such marks by Panasonic Corporation is under license.
- Microsoft, Outlook, Internet Explorer, Windows and Windows Vista are either registered trademarks or trademarks of Microsoft Corporation in the United States and/or other countries.
- Mozilla and Firefox are registered trademarks of the Mozilla Foundation.
- All other trademarks identified herein are the property of their respective owners.
- Microsoft product screen shot(s) reprinted with permission from Microsoft Corporation.

# Table of Contents

- 1 Safety Precautions .....13**
- 1.1 For Your Safety .....14
- 1.2 Important Safety Instructions .....20
- 1.3 Precautions .....21
- 1.4 Data Security .....22
- 2 System Outline .....23**
- 2.1 Basic System Construction .....24
- 2.1.1 System Configurations .....24
- 2.1.2 System Connection Diagram .....26
- 2.2 Optional Equipment .....28
- 2.2.1 Optional Equipment .....28
- 2.3 Specifications .....32
- 2.3.1 General Description .....32
- 2.3.2 Characteristics .....34
- 2.3.3 System Capacity .....35
- 3 Information about the Activation Keys .....47**
- 3.1 Information about the Activation Keys .....48
- 3.1.1 Type and Maximum Number of Activation Keys .....48
- 3.1.2 Activation Key Code and Key Management System .....56
- 3.1.3 Using CTI Applications .....57
- 4 Installation .....59**
- 4.1 Before Installation .....60
- 4.1.1 Before Installation .....60
- 4.2 Installation of the PBX .....62
- 4.2.1 Unpacking .....62
- 4.2.2 Names and Locations .....63
- 4.2.3 Opening/Closing the Top Cover .....65
- 4.2.4 Frame Earth Connection .....67
- 4.2.5 Installing/Removing the Optional Service Cards .....68
- 4.2.6 Installing/Removing the SD Memory Card .....82
- 4.2.7 Types of Connectors .....85
- 4.2.8 Attaching a Ferrite Core .....87
- 4.2.9 19-inch Rack Mounting .....88
- 4.2.10 Wall Mounting .....89
- 4.2.11 Surge Protector Installation .....93
- 4.2.12 Backup Battery Connection .....96
- 4.3 The Mother Board and Expansion Cards .....98
- 4.3.1 Mother Board .....98
- 4.3.1.1 Mother Board - KX-NS300 .....98
- 4.3.1.2 Mother Board - KX-NS320 .....100
- 4.3.2 SD Memory XS Card (KX-NS3134), SD Memory S Card (KX-NS3135), SD Memory M Card (KX-NS3136) .....101
- 4.3.3 DSP S Card (KX-NS5110) .....102
- 4.3.4 LCOT6 in KX-NS300 (installed by default) .....104
- 4.3.5 DLC2 in KX-NS300 (installed by default) .....107
- 4.3.6 MCSLC16 in KX-NS300 (installed by default) .....108
- 4.3.7 EXP-S in KX-NS320 (installed by default) .....110
- 4.3.8 PFT in KX-NS320 (installed by default) .....111
- 4.3.9 MCSLC16 in KX-NS320 (installed by default) .....113

4.3.10	RMT card in KX-NS300 (KX-TDA0196)	115
<b>4.4</b>	<b>Virtual Cards</b>	<b>116</b>
<b>4.5</b>	<b>Physical Trunk and Extension Cards</b>	<b>118</b>
4.5.1	LCOT6 Card (KX-NS5180)	118
4.5.2	PRI30/E1 Card (KX-NS5290CE)	119
4.5.3	DHLC4 Card (KX-NS5170)	122
4.5.4	DLC8 Card (KX-NS5171)	123
4.5.5	DLC16 Card (KX-NS5172)	124
4.5.6	MCSLC8 Card (KX-NS5173)	125
4.5.7	MCSLC16 Card (KX-NS5174)	126
<b>4.6</b>	<b>Expansion Card</b>	<b>127</b>
4.6.1	EXP-M Card (KX-NS5130)	127
<b>4.7</b>	<b>The Doorphone Card</b>	<b>129</b>
4.7.1	DPH2 Card (KX-NS5162)	129
<b>4.8</b>	<b>Connection of Extensions</b>	<b>131</b>
4.8.1	Maximum Cabling Distances of the Extension Wiring (Twisted Cable)	131
4.8.2	Parallel Connection of the Extensions	132
4.8.3	Digital EXtra Device Port (Digital XDP) Connection	134
<b>4.9</b>	<b>Connecting to a Doorphone, Door Opener, and/or External Sensor</b>	<b>136</b>
<b>4.10</b>	<b>Connection of Peripherals</b>	<b>138</b>
<b>4.11</b>	<b>LAN Connection</b>	<b>140</b>
4.11.1	LAN Connection for the Main Unit	140
4.11.2	LAN Connections for IP Telephones	142
<b>4.12</b>	<b>Power Failure Connections</b>	<b>145</b>
<b>4.13</b>	<b>Starting the KX-NS300</b>	<b>147</b>
<b>5</b>	<b>Programming Information</b>	<b>151</b>
<b>5.1</b>	<b>Overview of Web Maintenance Console</b>	<b>152</b>
<b>5.2</b>	<b>PC Connection</b>	<b>153</b>
<b>5.3</b>	<b>Starting Web Maintenance Console</b>	<b>156</b>
<b>5.4</b>	<b>Programming the PBX</b>	<b>165</b>
5.4.1	Easy Setup Wizard	165
5.4.2	Enabling the DHCP Server Feature	169
5.4.3	Installing the Virtual IP Cards to the PBX	169
5.4.4	Installing Additional Activation Keys	170
5.4.5	Configuration of the Activation Keys	170
<b>5.5</b>	<b>Programming an H.323 QSIG Network</b>	<b>172</b>
5.5.1	Assigning the Hunt Pattern	172
5.5.2	Programming the Address Translation Table	173
5.5.3	Programming the Network Settings	175
<b>5.6</b>	<b>Programming SIP Trunks</b>	<b>177</b>
<b>5.7</b>	<b>Assigning Networking Information to IP Telephones</b>	<b>179</b>
5.7.1	Assigning IP Addressing Information	179
5.7.2	Setting VLAN Parameters	199
5.7.3	Setting LLDP Parameters	202
5.7.4	Setting Diffserv Parameters	206
5.7.5	Configuration of IP Ports	209
5.7.6	ECO mode (KX-NT500 series only)	215
<b>5.8</b>	<b>Registering IP Telephones</b>	<b>217</b>
5.8.1	Registering IP Telephones	217
5.8.2	De-registering IP Telephones	223
5.8.3	Installing SIP Phones at a Remote Site	226
5.8.4	Installing IP Phones at a Remote Site with a Built-in Media Relay Gateway	232
<b>5.9</b>	<b>Configuration of Users</b>	<b>240</b>
<b>5.10</b>	<b>Programming E-mail Integration for UM Voice</b>	<b>242</b>

5.11	Automatic Configuration of Mailboxes .....	246
<b>6</b>	<b>Methods of Stacking Expansion Units .....</b>	<b>249</b>
6.1	Methods of Stacking Expansion Units .....	250
<b>7</b>	<b>Troubleshooting .....</b>	<b>253</b>
7.1	Troubleshooting .....	254
7.1.1	Installation .....	254
7.1.2	Connection .....	257
7.1.3	Operation .....	258
7.1.4	Error Messages .....	259
7.1.5	Restarting the KX-NS300 .....	261
7.1.6	Troubleshooting by Error Log .....	263
<b>8</b>	<b>Networking Information .....</b>	<b>265</b>
8.1	Information about Using an IP Network .....	266
8.1.1	Using a VoIP Network with the PBX .....	266
8.1.2	DHCP (Dynamic Host Configuration Protocol) Server .....	269
8.1.3	VLAN (Virtual LAN) .....	270
8.1.4	Jitter Buffer .....	271
8.1.5	Voice Activity Detection (VAD) .....	271
8.1.6	Network Configuration .....	272
8.1.7	Network Devices .....	276
8.1.8	QoS (Quality of Service) .....	277
8.1.9	Network Time Protocol (NTP) .....	278
8.2	<b>H.323 Trunks .....</b>	<b>279</b>
8.2.1	Avoid Multiple IP Networks .....	279
8.2.2	Gatekeeper .....	280
8.2.3	Bandwidth Assessment .....	280
8.2.4	Virtual VoIP Gateway Card Specifications .....	283
8.3	<b>SIP Trunks .....</b>	<b>284</b>
8.3.1	IP Telephony Service .....	284
8.3.2	SIP Requirements .....	287
8.3.3	Router Requirements .....	287
8.3.4	Bandwidth Requirements .....	287
8.3.5	Virtual SIP Trunk Card Specifications .....	289
8.4	<b>Types of PBX Networks .....</b>	<b>290</b>
8.4.1	H.323 QSIG Network .....	290
8.5	<b>Port Security .....</b>	<b>291</b>
<b>9</b>	<b>Appendix .....</b>	<b>295</b>
9.1	PBX Region Suffix Codes and Areas .....	296
9.2	System Prompt Languages .....	297

---

# **Section 1**

## **Safety Precautions**

*This section provides important information intended to prevent personal injury and property damage.*

# 1.1 For Your Safety

To prevent personal injury and/or damage to property, be sure to observe the following safety precautions.

The following symbols classify and describe the level of hazard and injury caused when this unit is operated or handled improperly.



This notice means that misuse could result in death or serious injury.



This notice means that misuse could result in injury or damage to property.

The following types of symbols are used to classify and describe the type of instructions to be observed.



This symbol is used to alert users to a specific operating procedure that must not be performed.



This symbol is used to alert users to a specific operating procedure that must be followed in order to operate the unit safely.



## WARNING

### For All Telephone Equipment



- Do not install the product in any other way than described in relevant manuals.
- Do not install the product in a place exposed to rain or moisture, or a place where water, oil, or other liquids can drip or splash onto on the product. Such conditions can lead to fire or electric shock, and may impair the performance of the product.
- Do not install the system in the following locations:
  - a. Areas where shocks or vibrations are frequent or strong. Such activity may lead to the product falling over and causing injury, or may impair the product's performance.
  - b. Areas with high amounts of dust. High amounts of dust can lead to fire or electric shock, and impair the performance of the product.
- Do not place the product on an unstable or uneven surface. If the product were to fall over, it may cause injury or damage to the product.
- Do not supply power to a combination of devices that exceeds the total rated capacity of the wall outlets or extension cables used. If outlets, power strips, extension cords, etc. are used in a manner that exceeds their rated capacity, they emit large amounts of heat, which could cause a fire.



- The product must only be installed and serviced by qualified service personnel. The product should be used as-is from the time of purchase; it should not be disassembled or modified. Disassembly or modification can cause a fire, electric shock, or damage to the product.
- Follow all warnings and instructions marked on the product.
- Small objects, such as the hook clip, SD card and battery connector cover, pose a choking hazard. Keep small objects out of reach of children.
- Products that require a power source should only be connected to the type of electrical power supply specified on the product label. If you are not sure of the type of power supply to your office/home, consult your dealer or local power company.
- For safety purposes some products are equipped with an earthed plug. If you do not have an earthed outlet, please have one installed. Do not bypass this safety feature by tampering with the plug.
- When installing telephone wiring, basic safety precautions should always be followed to reduce the risk of fire, electric shock and injury to persons, including the following:
  - a. Never install telephone wiring during a lightning storm.
  - b. Never install telephone jacks in wet locations unless the jack is specifically designed for wet locations.
  - c. Never touch uninsulated telephone wires or terminals unless the telephone line has been disconnected at the network interface.
  - d. Use caution when installing or modifying telephone lines.
  - e. Anti-static precautions should be taken during installation.
- Unplug the product from the wall outlet and have it serviced by qualified service personnel in the following cases:
  - a. When the power supply cord or plug is damaged or frayed.
  - b. If liquid has been spilled into the product.
  - c. If the product has been exposed to rain or water.

## 1.1 For Your Safety

---

- d.** If the product does not operate according to the operating instructions. Adjust only the controls that are explained in the operating instructions. Improper adjustment of other controls may result in damage and may require service by a qualified technician to restore the product to normal operation.
- e.** If the product has been dropped or the cabinet has been damaged.
- f.** If product performance deteriorates.

### For the PBX



- Do not insert foreign objects of any kind into this product, as they may touch dangerous voltage points or short out parts that could result in a fire or electric shock.
- Do not pull, bend, rest objects on, or chafe the power cord and plug. Damage to the power cord or plug can cause fire or electric shock.
- Do not attempt to repair the power cord or plug. If the power cord or plug is damaged or frayed, contact an authorised Panasonic Factory Service Centre for a replacement.
- Do not leave the slot open if an option service card is not installed after removing a dummy cover plate. Make sure to insert the slot cover included with the option service card into the slot.



- When mounting the PBX on a 19-inch rack, only use the 19-inch rack mounting equipment (attachment bracket, screws) made for use with the PBX.
- If damage to the unit exposes any internal parts, disconnect the power supply cord immediately and return the unit to your dealer.
- To prevent fires, electric shock, injury, or damage to the product, be sure to follow these guidelines when performing any wiring or cabling:
  - a.** Before performing any wiring or cabling, unplug the product's power cord from the outlet. After completing all wiring and cabling, plug the power cord back into the outlet.
  - b.** When laying cables, do not bundle the product's power cord with the power cords of other devices.
  - c.** Do not place any objects on top of the cables connected to the PBX.
  - d.** When running cables along the floor, use protectors to prevent the cables from being stepped on.
  - e.** Do not run any cables under carpeting.
- Unplug this unit from the AC outlet if it emits smoke, an abnormal smell or makes unusual noise. These conditions can cause fire or electric shock. Confirm that smoke has stopped and contact an authorised Panasonic Factory Service Centre.
- Make sure that the wall that the unit will be attached to is made of concrete or thick wood, and is strong enough to support the unit (approx. 35 kg). Do not attach the unit to walls made from plasterboard or thin plywood. Attaching the unit to areas where there are strong winds, or where shocks or vibrations are frequent or strong, may lead to the product falling over.
- Only use the wall-mounting equipment (screws and washers) included with the PBX.
- The earthing wire of the AC cable has an effect against external noise and lightning strikes, but it may not be enough to protect the PBX and to ensure electromagnetic compatibility. A permanent connection between earth and the earth terminal of the PBX must be made.
- Proper earthing (connection to earth) is very important to reduce the risk to the user of electrocution or to protect the PBX from the bad effects of external noise in the case of a lightning strike. (See "4.2.4 Frame Earth Connection".)
- Plug the power cord firmly into an AC outlet. Otherwise, it can cause fire or electric shock.
- Be careful not to drop any components. Dropping components may damage them or cause an injury.



- Make sure that the AC outlet is properly earthed, then securely connect the 3-pin AC plug including the earthed pin.
- A lithium battery is used in the main unit. There is a risk of explosion if the battery is replaced with an incorrect type. Dispose of used batteries according to the manufacturer's instructions.



## CAUTION

### For All Telephone Equipment



- The product should be kept free of dust, moisture, high temperature (more than 40 °C) and vibration, and should not be exposed to direct sunlight.
- Unplug the product from the wall outlet before cleaning. Wipe the product with a soft cloth. Do not clean with abrasive powders or with chemical agents such as benzine or thinner. Do not use liquid cleaners or aerosol cleaners.

### For the PBX



- Do not install the system in the following locations:
  - a. In direct sunlight and hot, cold, or humid places. (Temperature range: 0 °C to 40 °C)
  - b. Areas where sulphuric gases may be present, such as near thermal springs.
  - c. Near devices that generate high frequencies, such as sewing machines or electric welders.
  - d. Locations where other objects will obstruct the area around the PBX. Be especially careful to leave at least 5 cm to the sides of the PBX for ventilation.
  - e. Locations where condensation can occur.
- Do not block the openings of the PBX. Allow space of at least 20 cm above and 10 cm at the sides of the PBX.
- When the PBX is mounted on a 19-inch rack, do not block the openings of the PBX. Allow space of at least 10 cm around the PBX's fan.
- When installing or removing the SD Memory Card, do not put pressure on any parts of the mother board. Doing so may result in damage to the PBX.
- When installing or removing the optional service cards, do not put pressure on any parts of the mother board. Doing so may result in damage to the PBX.
- Once you have started the PBX, if you unplug the PBX, do not initialise it again as described in "System Initialisation Procedure". Otherwise, your programmed data will be cleared. To restart the PBX, refer to "7.1.5 Restarting the KX-NS300".



- Before touching the product (PBX, cards, etc.), discharge static electricity by touching ground or wearing an earthing strap. Failure to do so may cause the PBX to malfunction due to static electricity.
- When relocating the equipment, first disconnect the telecom connection before disconnecting the power connection. When the unit is installed in the new location, reconnect the power first, and then reconnect the telecom connection.

## 1.1 For Your Safety

---

- The plug of power supply cordset is used as the main disconnect device. Ensure that the AC outlet is located near the equipment and is easily accessible.
- Slots and openings in the front, back and bottom of the cabinet are provided for ventilation; to protect it from overheating, these openings must not be blocked or covered. The openings should never be blocked by placing the product on a bed, sofa, rug, or other similar surface while in use. The product should never be placed near or over a radiator or other heat source. This product should not be placed in a sealed environment unless proper ventilation is provided.
- Make sure that the surface behind the PBX is flat and free of obstacles, so that the openings on the back of the PBX will not be blocked.
- When this product is no longer in use, make sure to detach it from the rack or wall.
- Use only the AC power cord included with the PBX. A certified power supply cord has to be used with this equipment. The relevant national installation and/or equipment regulations shall be considered. A certified power supply cord not lighter than ordinary polyvinyl chloride flexible cord according to IEC 60227 (designation H05VV-F 3G 0.75 mm<sup>2</sup>) shall be used.
- When the PBX is mounted on a 19-inch rack, make sure that the installation of the unit does not cause the temperature of the rack to exceed its limit.
- Make sure to install all necessary optional service cards in the PBX before performing the wall mounting procedure. If it is necessary to install or remove a card, make sure to detach the PBX from the wall before installing or removing the card.
- When driving the screws into the wall, be careful to avoid touching any metal laths, wire laths or plates in the wall.
- When opening the top cover, the power switch must be turned off.
- For safety reasons, close the top cover and tighten the screws before operating the PBX.
- If the PBX is not installed properly using the securing correct methods, the PBX may fall causing serious damage.
- Performing surge protection is essential. Make sure to follow the instructions in "4.2.11 Surge Protector Installation".
- It is strongly recommended to use SSL encrypted communication when the PC is accessing the PBX via the Internet. To use SSL encryption, routers must have a port set up for https communication.
- Avoid using the same AC outlet for computers and other office equipment, as noise generated by such equipment may hamper system performance or interrupt the system.
- Unplug the system from its power source when wiring, and plug the system back in only after all wiring is completed.
- Trunks should be installed with surge protectors. For details, refer to "4.2.11 Surge Protector Installation".
- When installing or removing the optional service cards, the power switch must be turned off.
- For earthing wire, green-and-yellow insulation is required, and the cross-sectional area of the conductor must be more than 0.75 mm<sup>2</sup> or 18 AWG.
- When connecting a PRI30/E1 card to the trunk, connect through an NT1; do not connect to the U interface of the trunk directly.
- PRI ports of PRI30/E1 card is SELV ports and should only be connected to SELV services.
- The MOH port and Pager port are SELV ports and should only be connected to approved SELV devices, or via a Line Isolation Unit with a Telecommunications Compliance Label.

### **WARNING**

This is a class A product. In a domestic environment this product may cause radio interference in which case the user may be required to take adequate measures.

**Notice****For All Telephone Equipment**

- Read and understand all instructions.

**For the PBX**

- Keep the unit away from heating appliances and devices that generate electrical noise such as fluorescent lamps, motors and televisions. These noise sources can interfere with the performance of the PBX.
- If you are having problems making calls to outside destinations, follow this procedure to test the trunks:
  - a. Disconnect the PBX from all trunks.
  - b. Connect known working SLTs to those trunks.
  - c. Make a call to an external destination using those SLTs.

If a call cannot be carried out correctly, there may be a problem with the trunk that the SLT is connected to. Contact your telephone company.

If all SLTs operate properly, there may be a problem with your PBX. Do not reconnect the PBX to the trunks until it has been serviced by an authorised Panasonic Factory Service Centre.

## 1.2 Important Safety Instructions

When using your telephone equipment, basic safety precautions should always be followed to reduce the risk of fire, electric shock and injury to persons, including the following:

- Do not use the product near water, for example, near a bathtub, wash bowl, kitchen sink, or laundry tub, in a wet basement, or near a swimming pool.
- Avoid using wired telephones during an electrical storm. There is a remote risk of electric shock from lightning.
- Do not use a telephone in the vicinity of a gas leak to report the leak.
- Rack Mount Instructions—The following or similar rack-mount instructions are included with the installation instructions:
  - a. Elevated Operating Ambient—If installed in a closed or multi-unit rack assembly, the operating ambient temperature of the rack environment may be greater than room ambient. Therefore, consideration should be given to installing the equipment in an environment compatible with the maximum ambient temperature (T<sub>ma</sub>) specified by the manufacturer.
  - b. Reliable Earthing—Reliable earthing of rack-mounted equipment should be maintained. Particular attention should be given to supply connections other than direct connections to the branch circuit (e.g., use of power strips).

**SAVE THESE INSTRUCTIONS**

## 1.3 Precautions

### For users in the European Union only

#### Information for Users on Collection and Disposal of Old Equipment and used Batteries

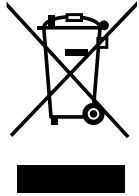

These symbols on the products, packaging, and/or accompanying documents mean that used electrical and electronic products and batteries should not be mixed with general household waste.

For proper treatment, recovery and recycling of old products and used batteries, please take them to applicable collection points, in accordance with your national legislation and the Directives 2002/96/EC and 2006/66/EC.

By disposing of these products and batteries correctly, you will help to save valuable resources and prevent any potential negative effects on human health and the environment which could otherwise arise from inappropriate waste handling.

For more information about collection and recycling of old products and batteries, please contact your local municipality, your waste disposal service or the point of sale where you purchased the items.

Penalties may be applicable for incorrect disposal of this waste, in accordance with national legislation.

#### For business users in the European Union

If you wish to discard electrical and electronic equipment, please contact your dealer or supplier for further information.



#### Information on Disposal in other Countries outside the European Union

These symbols are only valid in the European Union. If you wish to discard these items, please contact your local authorities or dealer and ask for the correct method of disposal.

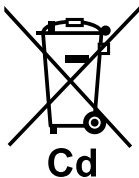

#### Note for the battery symbol (bottom two symbol examples):

This symbol might be used in combination with a chemical symbol. In this case it complies with the requirement set by the Directive for the chemical involved.

# 1.4 Data Security

In order to use the PBX safely and correctly, the Security Requirements below must be observed. Failure to do so may result in:

- Loss, leakage, falsification or theft of user information.
- Illegal use of the PBX by a third party.
- Interference or suspension of service caused by a third party.

### **What is User Information?**

User Information is defined as:

1. Information stored on the SD Memory Card:  
Sound files for UM feature and call charge data.
2. Information sent from the PBX to a PC or a USB memory device:  
System data, sound files for MOH (Music on Hold) and OGM (Outgoing Messages), and activation key files.

### **Requirements**

1. Always make backups of data stored on the System memory and/or perform regular system data backups to a USB memory device.  
For details about making backups of data stored on the System memory, refer to "7.2.2 Utility—File—File Transfer PBX to PC" in the PC Programming Manual.  
For details about backing up the system data to a USB memory device, refer to "6.1.1 Tool—System Data Backup—Backup to USB" in the PC Programming Manual.
2. To prevent illegal access from the Internet, activate a Firewall.
3. To avoid unauthorised access and possible abuse of the PBX, we strongly recommend:
  - a. Keeping the password secret.
  - b. Selecting a complex, random password that cannot be easily guessed.
  - c. Changing your password regularly.
4. Perform the following when sending the PBX for repair or handing it over to a third party.
  - a. Make a backup of data stored on the System memory.
5. When user information is sent from the PBX to a PC or a USB memory device, the confidentiality of that information becomes the responsibility of the customer. Before disposing of the PC or the USB memory device, ensure that data cannot be retrieved from it by formatting the hard disk and/or rendering it physically unusable.

---

## **Section 2**

# **System Outline**

*This section provides general information on the PBX, including the system capacity and specifications.*

## 2.1 Basic System Construction

### 2.1.1 System Configurations

#### Main Unit

The main unit contains a mother board for controlling PBX functions.

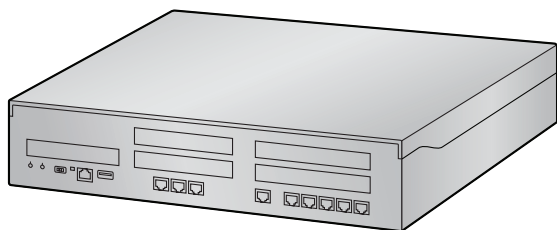

#### Stacking Expansion Unit KX-NS320

Up to 3 Expansion Unit KX-NS320s can be connected to a KX-NS300 to expand the usage of legacy terminals and trunks. A KX-NS320 connected to a KX-NS300 functions as an expansion unit and will be controlled by the KX-NS300.

To connect a KX-NS320 as an expansion unit, install a EXP-M card in the KX-NS300. Then, connect the EXP-M card and the EXP-S which is in KX-NS320 directly with Category 5 cable.

For details about connecting KX-NS300 and expansion unit KX-NS320, see "4.6.1 EXP-M Card (KX-NS5130)".

**Example:**

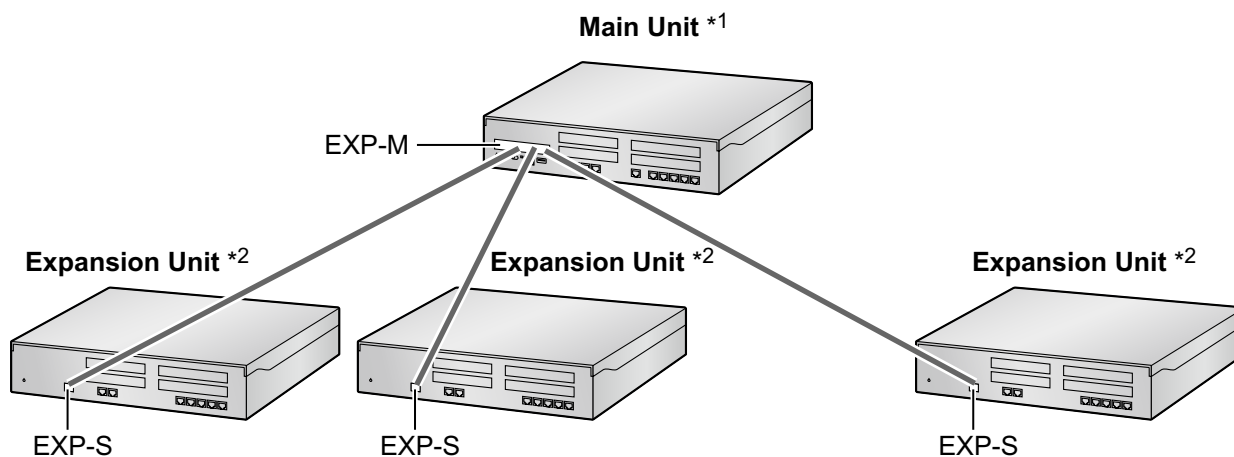

\*1 KX-NS300

\*2 KX-NS320

#### H.323 QSIG network

If the network will include non-KX-NS300 PBXs (e.g., KX-TDE200, KX-NCP500), then an H.323 QSIG network is necessary.



An H.323 QSIG network is preferable if strict resource separation between sites is necessary. In a QSIG network, resources are not available to extension users of other PBXs without explicit programming. For details about programming the H.323 QSIG network, refer to "5.5 Programming an H.323 QSIG Network".

## 2.1.2 System Connection Diagram

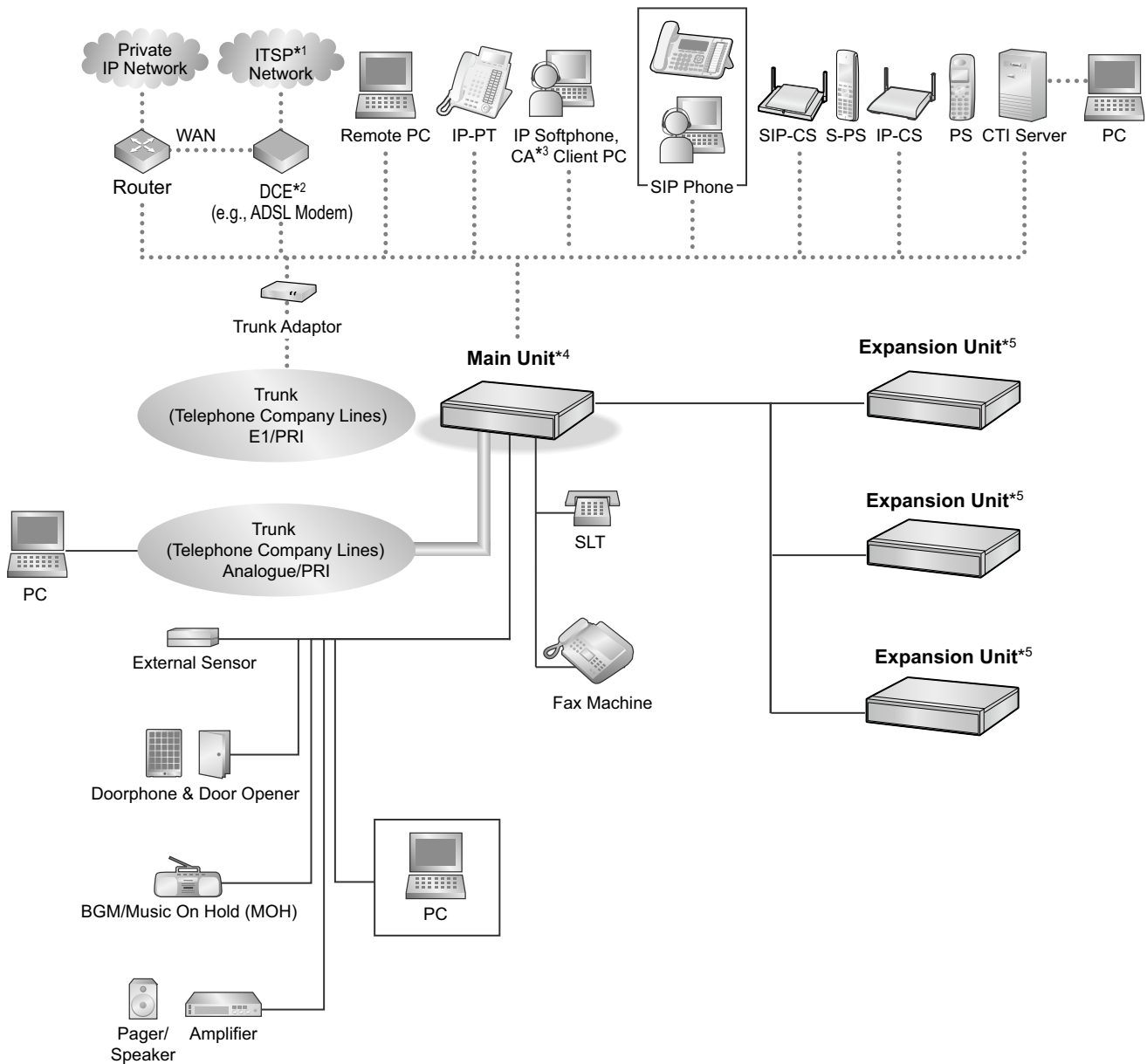

\*1 ITSP: Internet Telephony Service Provider  
 \*2 DCE: Data Circuit Terminating Equipment  
 \*3 CA: Communication Assistant  
 \*4 KX-NS300  
 \*5 KX-NS320

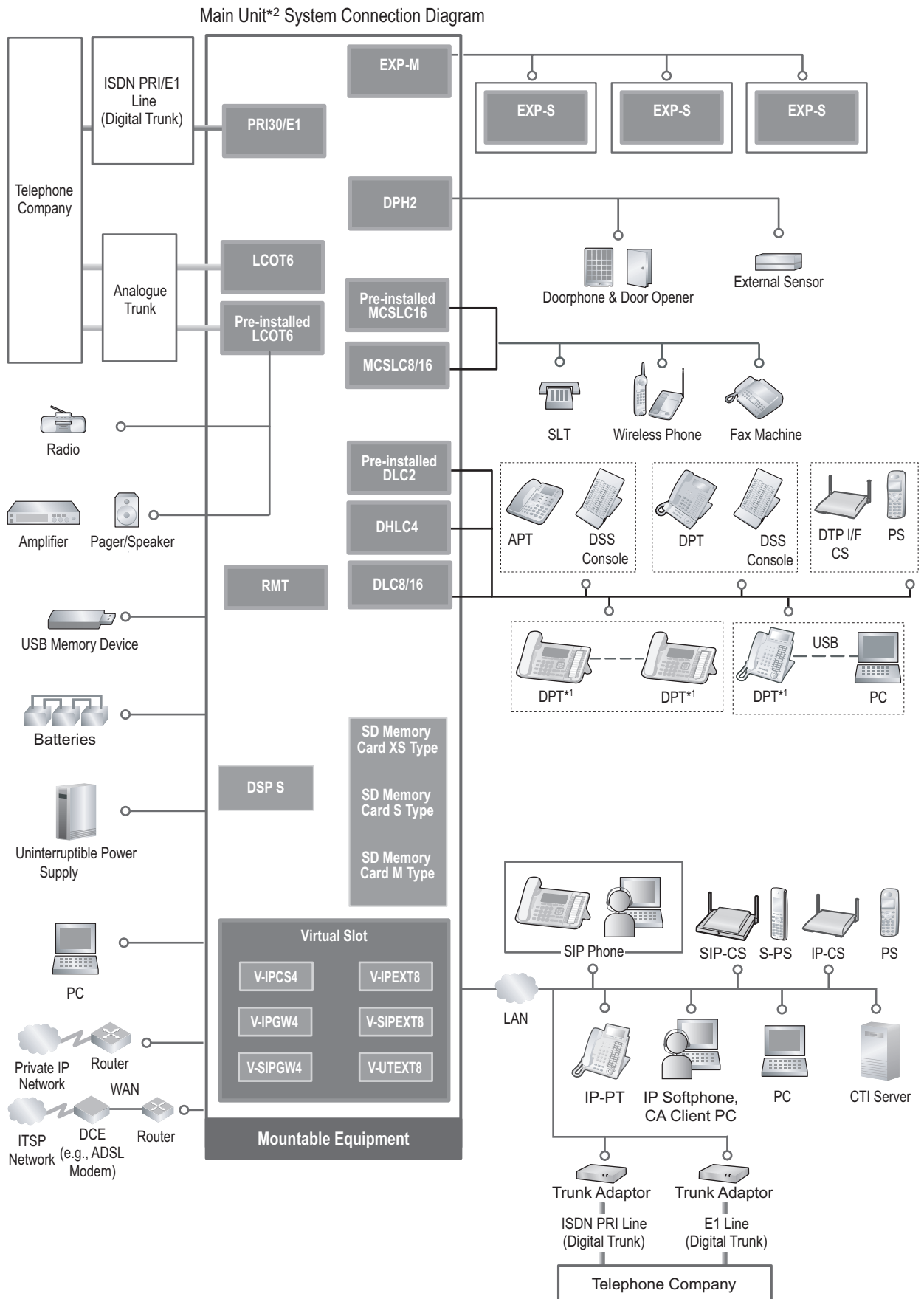

\*1 Some DPT is not available for this connection.

\*2 KX-NS300

## 2.2.1 Optional Equipment

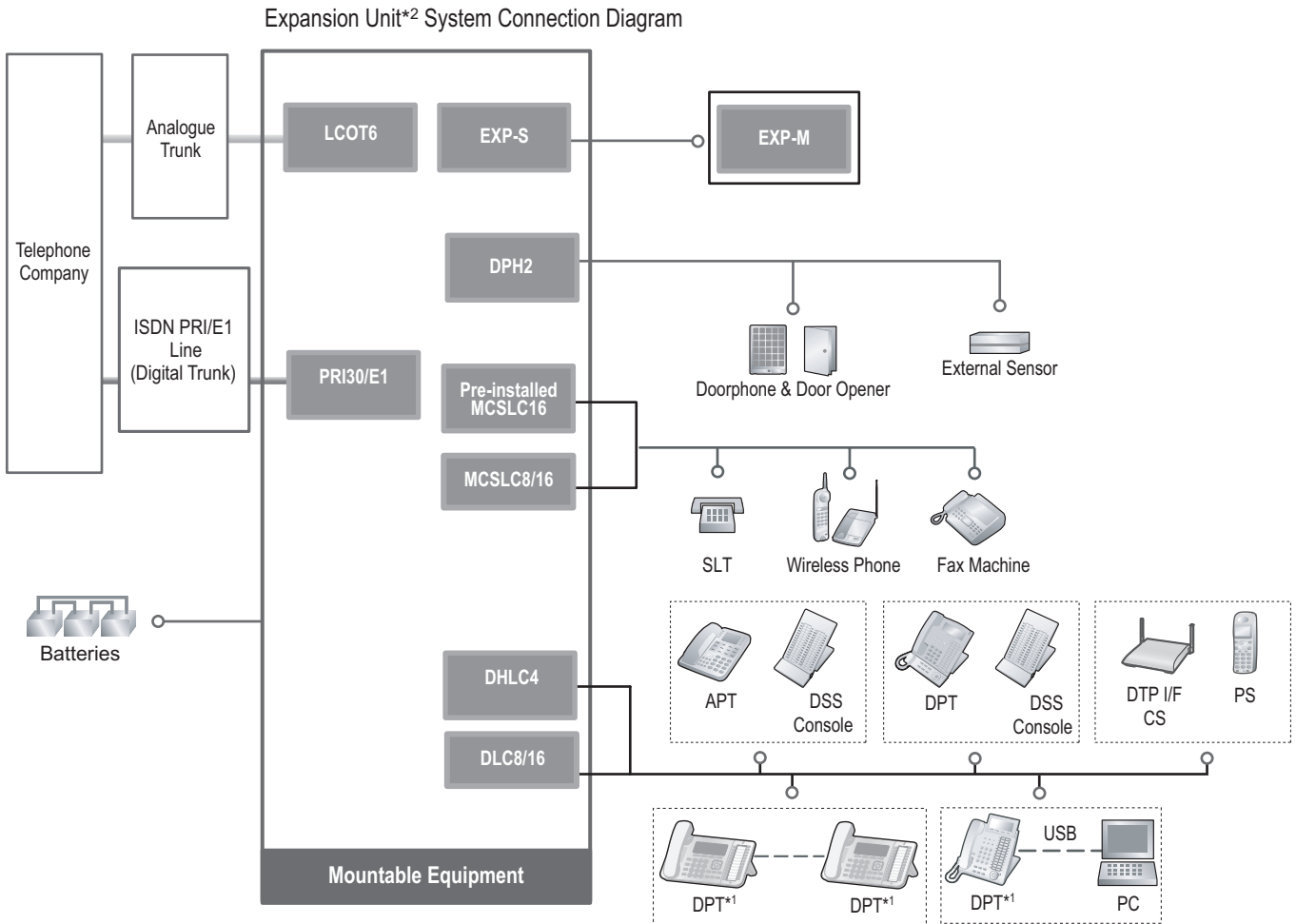

\*<sup>1</sup> Some DPT is not available for this connection.

\*<sup>2</sup> KX-NS320

## 2.2 Optional Equipment

### 2.2.1 Optional Equipment

#### KX-NS300

Model No.	Model Name	Description
KX-NS5110	VoIP DSP Card (S Type) (DSP S)	<p>A DSP card is a digital signal processor card with DSP resources that can be used for VoIP calls, conferences, the Unified Messaging feature, and the DISA/OGM feature. The DSP card is compliant with ITU-T G.729A and G.711 codec methods.</p> <p>To operate VoIP, DISA, Conference or Unified Messaging, DSP S card must be installed in the DSP card slots.</p>

Model No.	Model Name	Description
KX-NS3134	SD Memory Card (XS Type) (SD Memory XS)	A combination card including <ul style="list-style-type: none"> <li>• Memory with maximum of 40 hours Voice Mail recording time.</li> <li>• Memory with Maximum of 40,000 SMDR data and 10,000 Hotel Billing Data</li> <li>• Store 300,000 ACD report data</li> <li>• You cannot install commercially available SD card.</li> <li>• When you update the Main Unit software, you need to install SD card or USB memory card.</li> </ul>
KX-NS3135	SD Memory Card (S Type) (SD Memory S)	A combination card including <ul style="list-style-type: none"> <li>• Memory with maximum of 200 hours Voice Mail recording time.</li> <li>• Memory with Maximum of 40,000 SMDR data and 10,000 Hotel Billing Data</li> <li>• Store 300,000 ACD report data</li> <li>• You cannot install commercially available SD card.</li> <li>• When you update the Main Unit software, you need to install SD card or USB memory card.</li> </ul>
KX-NS3136	SD Memory Card (M Type) (SD Memory M)	A combination card including <ul style="list-style-type: none"> <li>• Memory with maximum of 400 hours Voice Mail recording time.</li> <li>• Memory with Maximum of 40,000 SMDR data and 10,000 Hotel Billing Data</li> <li>• Store 300,000 ACD report data</li> <li>• You cannot install commercially available SD card.</li> <li>• When you update the Main Unit software, you need to install SD card or USB memory card.</li> </ul>
KX-NS5162	Doorphone Interface Card (DPH2)	2-port doorphone card for 2 doorphone, 2 door opener, and 2 external sensor.
KX-NS5180	6-port Analogue Trunk Card (LCOT6)	6 analogue trunk ports with Caller ID (FSK/FSK with Call Waiting Caller ID [Visual Caller ID]/DTMF). Two ports are power failure transfer (PFT) port.
KX-NS5290CE	PRI30/E1 Card (PRI30/E1)	A combination card including: <ul style="list-style-type: none"> <li>• 1 ISDN Primary Rate Interface port (30B channels).</li> </ul> EURO-ISDN/ETSI compliant. <ul style="list-style-type: none"> <li>• 1 E1 port (30B channels).</li> </ul> ITU-T standard compliant.

## 2.2.1 Optional Equipment

---

Model No.	Model Name	Description
KX-NS5130	3-port expansion Master Card (EXP-M)	A stacking card to be installed in a KX-NS300. Up to 3 Expansion Unit KX-NS320 can be connected.
KX-NS5170	4-Port Super Hybrid Extension Card (DHLC4)	4-port digital hybrid extension card for DPTs, APTs, SLTs, DSS consoles, and PT-interface CSs.
KX-NS5171	8-Port Digital Extension Card (DLC8)	8-port digital extension card for DPTs, DSS consoles, and PT-interface CSs.
KX-NS5172	16-port Digital Extension Card (DLC16)	16-port digital extension card for DPTs, DSS consoles, and PT-interface CSs.
KX-NS5173	8-Port Single Line Telephone Extension Card (MCSLC8)	8-port extension card for SLTs with Caller ID (FSK), Message Waiting Lamp control.
KX-NS5174	16-Port Single Line Telephone Extension Card (MCSLC16)	16-port extension card for SLTs with Caller ID (FSK), Message Waiting Lamp control.

### **Note**

For the maximum number of optional service cards that can be installed in the PBX, refer to "2.3.3 System Capacity".

**KX-NS320**

<b>Model No.</b>	<b>Model Name</b>	<b>Description</b>
KX-NS5162	Doorphone Interface Card (DPH2)	2-port doorphone card for 2 doorphone, door opener and 2 external sensor
KX-NS5180	6-port Analogue Trunk Card (LCOT6)	6 analogue trunk ports with Caller ID (FSK/FSK with Call Waiting Caller ID [Visual Caller ID]/DTMF).
KX-NS5290CE	PRI30/E1 Card (PRI30/E1)	A combination card including: <ul style="list-style-type: none"> <li>• 1 ISDN Primary Rate Interface port (30B channels).</li> </ul> EURO-ISDN/ETSI compliant. <ul style="list-style-type: none"> <li>• 1 E1 port (30B channels).</li> </ul> ITU-T standard compliant.
KX-NS5170	4-Port Super Hybrid Extension Card (DHLC4)	4-port digital hybrid extension card for DPTs, APTs, SLTs, DSS consoles, and PT-interface CSs.
KX-NS5171	8-Port Digital Extension Card (DLC8)	8-port digital extension card for DPTs, DSS consoles, and PT-interface CSs.
KX-NS5172	16-port Digital Extension Card (DLC16)	16-port digital extension card for DPTs, DSS consoles, and PT-interface CSs.
KX-NS5173	8-Port Single Line Telephone Extension Card (MCSLC8)	8-port extension card for SLTs with Caller ID (FSK), Message Waiting Lamp control.
KX-NS5174	16-Port Single Line Telephone Extension Card (MCSLC16)	16-port extension card for SLTs with Caller ID (FSK), Message Waiting Lamp control.

## 2.3 Specifications

### 2.3.1 General Description

#### KX-NS300

<b>Main CPU</b>		Cortex A8 600 MHz
<b>Power Input</b>		100 V AC to 130 V AC: 2.2 A/200 V AC to 240 V AC: 1.3 A; 50 Hz/60 Hz
<b>Power Consumption (when fully mounted)</b>		110 W
<b>External Backup Battery</b>		External battery port is supported.
<b>Memory Backup Duration</b>		7 years
<b>Dialling</b>	<b>Trunk</b>	Dial Pulse (DP) 10 pps, 20 pps Tone (DTMF) Dialling with Caller ID (FSK/DTMF) 1600 Ω Maximum
	<b>Extension</b>	Dial Pulse (DP) 10 pps, 20 pps Tone (DTMF) Dialling with Caller ID (FSK/DTMF) Port 1-2 (on pre-installed MCSLC16) support PFT in combination with the port 1-2 (on pre-installed LCOT6) connected to an analogue trunk respectively.
<b>Mode Conversion</b>		DP-DTMF, DTMF-DP
<b>Ring Frequency</b>		20 Hz/25 Hz (selectable)
<b>Operating Environment</b>	<b>Temperature</b>	0 °C to 40 °C
	<b>Humidity</b>	10 % to 90 % (non-condensing)
<b>Conference Call Trunk</b>		From 10 × 3-party conference call to 4 × 8-party conference call
<b>Music on Hold (MOH)</b>		Maximum 8 ports (Level Control: 31.5 dB to +31.5 dB per 0.5 dB) MOH: Selectable Internal/External Music Source Port
<b>External Paging</b>		Maximum 6 Ports (Volume Control: -15.5 dB to per 0.5 dB)
<b>LAN Port</b>	1 (for LAN connection)	10BASE-T/100BASE-TX (Auto MDI/MDI-X)
<b>Extension Connection Cable</b>	SLT	1-pair wire (T, R)
	DPT	1-pair wire (D1, D2) or 2-pair wire (T, R, D1, D2)
	PT-interface CS	1-pair wire (D1, D2)
	PT-interface CS (High-density)	4-pair wire (D1, D2)
	DSS Console and Add-on Key Module	1-pair wire (D1, D2)
<b>Air-cooling method</b>		FAN
<b>Dimension</b>		430 mm (W) × 88 mm (H) × 367 mm (D)



<b>Weight (when fully mounted)</b>	Under 4.5 kg <sup>*1</sup>
------------------------------------	----------------------------

\*1 Except the 19-inch rack mounting equipment

### KX-NS320

<b>Main CPU</b>		Cortex A8 300 MHz	
<b>Power Input</b>		100 V AC to 130 V AC: 2.2 A/200 V AC to 240 V AC: 1.3 A; 50 Hz/60 Hz	
<b>Power Consumption (when fully mounted)</b>		110 W	
<b>External Backup Battery</b>		External battery port is supported.	
<b>Memory Backup Duration</b>		7 years	
<b>Dialling</b>	<b>Trunk</b>	Dial Pulse (DP) 10 pps, 20 pps Tone (DTMF) Dialling with Caller ID (FSK/DTMF) 1600 Ω Maximum	
	<b>Extension</b>	Dial Pulse (DP) 10 pps, 20 pps Tone (DTMF) Dialling with Caller ID (FSK/DTMF) Port 1-4 (on pre-installed MCSLC16) support PFT feature. Refer to "4.12 Power Failure Connections" for more information.	
<b>Mode Conversion</b>		DP-DTMF, DTMF-DP	
<b>Ring Frequency</b>		20 Hz/25 Hz (selectable)	
<b>Operating Environment</b>	<b>Temperature</b>	0 °C to 40 °C	
	<b>Humidity</b>	10 % to 90 % (non-condensing)	
<b>Extension Connection Cable</b>		SLT	1-pair wire (T, R)
		DPT	1-pair wire (D1, D2) or 2-pair wire (T, R, D1, D2)
		PT-interface CS	1-pair wire (D1, D2)
		PT-interface CS (High-density)	4-pair wire (D1, D2)
		DSS Console and Add-on Key Module	1-pair wire (D1, D2)
<b>Air-cooling method</b>		FAN	
<b>Dimension</b>		430 mm (W) × 88 mm (H) × 367 mm (D)	
<b>Weight (when fully mounted)</b>		Under 4.5 kg <sup>*1</sup>	

\*1 Except the 19-inch rack mounting equipment

## 2.3.2 Characteristics

### KX-NS300

<b>Terminal Equipment Loop Limit</b>	<ul style="list-style-type: none"> <li>• SLT: 600 <math>\Omega</math> including set</li> <li>• Doorphone: 20 <math>\Omega</math></li> </ul>
<b>Minimum Leakage Resistance</b>	15 000 $\Omega$ minimum
<b>Maximum Number of Extension Instruments per Line</b>	1 for SLT
<b>Ring Voltage</b>	75 Vrms at 20 Hz/25 Hz depending on the Ringing Load
<b>Trunk Loop Limit</b>	1600 $\Omega$ maximum
<b>Hookswitch Flash/Recall Timing Range</b>	24 ms to 2032 ms
<b>Door Opener Current Limit</b>	24 V DC/30 V AC, 1 A maximum
<b>External Sensor Current Limit</b>	Power to the external sensor is provided from the DPH2 card and must be grounded through the DPH2 card. For the connection diagram, refer to "4.7.1 DPH2 Card (KX-NS5162)". The PBX detects input from the sensor when the signal is under 100 $\Omega$ .
<b>Paging Terminal Impedance</b>	600 $\Omega$
<b>MOH (Music on Hold) Terminal Impedance</b>	10 000 $\Omega$

### KX-NS320

<b>Terminal Equipment Loop Limit</b>	<ul style="list-style-type: none"> <li>• SLT: 600 <math>\Omega</math> including set</li> <li>• Doorphone: 20 <math>\Omega</math></li> </ul>
<b>Minimum Leakage Resistance</b>	15 000 $\Omega$ minimum
<b>Maximum Number of Extension Instruments per Line</b>	1 for SLT
<b>Ring Voltage</b>	75 Vrms at 20 Hz/25 Hz depending on the Ringing Load
<b>Trunk Loop Limit</b>	1600 $\Omega$ maximum
<b>Hookswitch Flash/Recall Timing Range</b>	24 ms to 2032 ms
<b>Door Opener Current Limit</b>	24 V DC/30 V AC, 1 A maximum
<b>External Sensor Current Limit</b>	Power to the external sensor is provided from the DPH2 card and must be grounded through the DPH2 card. For the connection diagram, refer to "4.7.1 DPH2 Card (KX-NS5162)". The PBX detects input from the sensor when the signal is under 100 $\Omega$ .
<b>Paging Terminal Impedance</b>	600 $\Omega$
<b>MOH (Music on Hold) Terminal Impedance</b>	10 000 $\Omega$

## 2.3.3 System Capacity

### Type and Maximum Number of Slots

The PBX supports the following type and number of slots.

#### KX-NS300 Mother Board

Slot Type		Maximum Number
Physical Slot	DSP Card Slot	1
	SD Card Slot	1
	EXP-M Card Slot	1
	Trunk Free Slot	2 <sup>1</sup>
	Extension Free Slot	1: If 16 ports Extension card is installed 2: If 16 ports Extension card is not installed
	Remote Card Slot	1
Virtual Slot <sup>2</sup>	Virtual Trunk Card	4
	Virtual Extension Card	4
	Virtual IP-CS Card	4

<sup>1</sup> For details about the available installation combination of cards, see "Trunk Option Card Installing Restrictions".

<sup>2</sup> If you want to use IP-Extension, IP-Trunk, IP-CS or Unified Messaging system, you need to install Activation key KX-NSF990.

#### KX-NS320 Mother Board

Slot Type		Maximum Number
Physical Slot	Trunk Free Slot	2 <sup>1</sup>
	Extension Free Slot	1: If 16 ports Extension card is installed 2: If 16 ports Extension card is not installed

<sup>1</sup> For details about the available installation combination of cards, see "Trunk Option Card Installing Restrictions".

### Main Unit

Front View

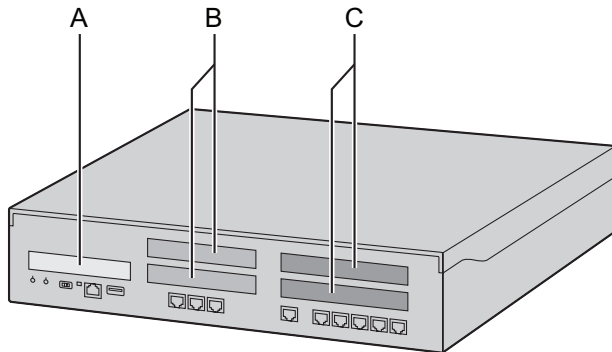

Inside View (The top cover is removed.)

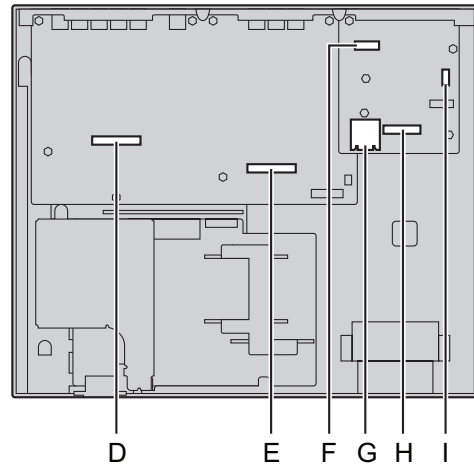

- A.** Front cover plate for the EXP-M Slot
- B.** Front cover plates for Trunk/Doorphone Card Slots
- C.** Front cover plates for the Extension Card Slots
- D.** Extension Card Slot
- E.** Trunk/Doorphone Card Slot
- F.** EXP-M Card Slot
- G.** SD Card Slot
- H.** DSP Card Slot
- I.** RMT Card Slot

## Expansion Unit

Front View

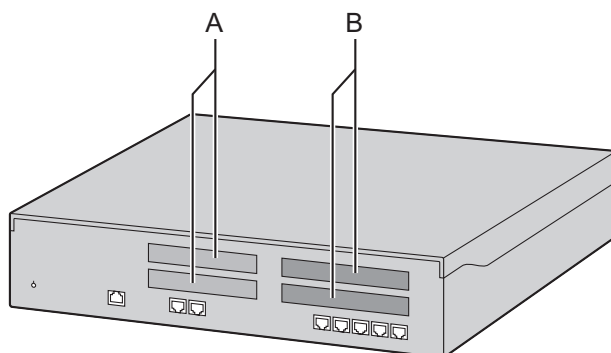

Inside View (The top cover is removed.)

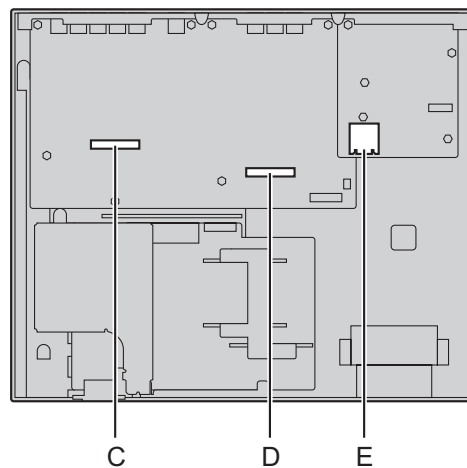

- A.** Front cover plates for Trunk/Doorphone Card Slots
- B.** Front cover plates for the Extension Card Slots
- C.** Extension Card Slot
- D.** Trunk/Doorphone Card Slot
- E.** SD Card Slot (not available)

### Virtual Slots of the Mother Board

Example:

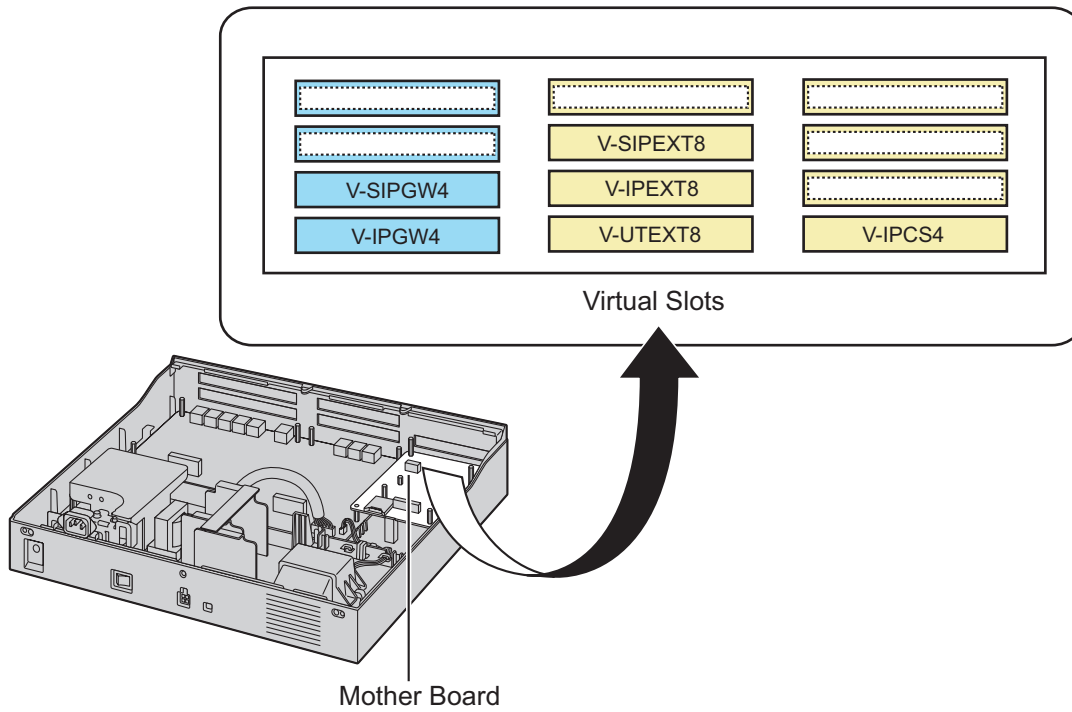

## Maximum Optional Service Cards

The following number of card can be installed in the Physical Slots or Virtual Slots of the PBX.

### Note

- Any card that exceeds the capacity of the PBX will be ignored.
- When the PBX starts up with an invalid configuration, some cards will be ignored.

## For KX-NS300 Physical Slot

Slot type	Card Name	Maximum Number
Pre-installed	LCOT6	1
	MCSLC16	1
	DLC2	1
DSP Card Slot	DSP S	1
SD Card Slot		1
	SD XS	1
	SD S	1
	SD M	1
Remote Card Slot	RMT	1
EXP-M Card Slot	EXP-M	1
Trunk Slot <sup>1</sup>		1
	LCOT6	1
	PRI30/E1	1
	DPH2	1
Extension Slot <sup>2</sup>	(Pattern 1)	2
	DHLC4	2
	DLC8	2
	MCSLC8	2
	(Pattern 2)	1
	DLC16	1
	MCSLC16	1

<sup>1</sup> You can install one DPH2 card and one of the Trunk card.

<sup>2</sup> For Extension Slot, you need to select Pattern 1 or Pattern 2.  
DLC16 or MCSLC16 card can be installed in first Extension Slot only.  
If you install DLC16 or MCSLC16 card in first Extension slot, you cannot install DHLC4, DLC8 or MCSLC8 in the second Extension slot.

## Cards Installed in Virtual Slots

Card type	Card Name	Maximum Number
Virtual Trunk Card		4
	V-IPGW4	4
	V-SIPGW4	4
Virtual Extension Card		4
	V-IPEXT8	4
	V-SIPEXT8	4
	V-UTEXT8	4
Virtual IP-CS Card	V-IPCS4	4

If you want to use IP-Extension, IP-Trunk, IP-CS or Unified Messaging system, you need to install Activation key KX-NSF990.

## For KX-NS320 Physical Slot

Slot type	Card Name	Maximum Number
Pre-installed	MCSLC16	1
Trunk Slot	DPH2	1
Trunk Slot		2
	LCOT6	2
	PRI30/E1	1
Extension Slot <sup>*1</sup>	(Pattern 1)	2
	DHLC4	2
	DLC8	2
	MCSLC8	2
	(Pattern 2)	1
	DLC16	1
	MCSLC16	1

\*1 For Extension Slot, you need to select Pattern 1 or Pattern 2.  
 DLC16 or MCSLC16 card can be installed in first Extension Slot only.  
 If you install DLC16 or MCSLC16 card in first Extension slot, you cannot install DHLC4, DLC8 or MCSLC8 in the second Extension slot.



## Trunk Option Card Installing Restrictions

### KX-NS300

		2nd Slot		
		LCOT6	PRI30/E1	DPH2
1st Slot	LCOT6	— <sup>*1</sup>	— <sup>*1</sup>	✓
	PRI30/E1	— <sup>*1</sup>	— <sup>*1</sup>	✓
	DPH2	✓	✓	— <sup>*1</sup>

<sup>\*1</sup> This installation combination is not available due to software restrictions.

### KX-NS320

		2nd Slot		
		LCOT6	PRI30/E1	DPH2
1st Slot	LCOT6	✓	— <sup>*1</sup>	✓
	PRI30/E1	— <sup>*1</sup>	— <sup>*1</sup>	✓
	DPH2	✓	✓	— <sup>*1</sup>

<sup>\*1</sup> This installation combination is not available due to software restrictions.

## Extension Option Card Installing Restrictions

### KX-NS300/KX-NS320

		2nd Slot				
		MCSLC16	MCSLC8	DLC16	DLC8	DHLC4
1st Slot	MCSLC16	— <sup>*1</sup>	— <sup>*1</sup>	— <sup>*1</sup>	— <sup>*1</sup>	— <sup>*1</sup>
	MCSLC8	— <sup>*1</sup>	✓	— <sup>*1</sup>	✓	✓
	DLC16	— <sup>*1</sup>	— <sup>*1</sup>	— <sup>*1</sup>	— <sup>*1</sup>	— <sup>*1</sup>
	DLC8	— <sup>*1</sup>	✓	— <sup>*1</sup>	✓	✓
	DHLC4	— <sup>*1</sup>	✓	— <sup>*1</sup>	✓	✓

<sup>\*1</sup> This installation combination is not available due to software restrictions.

## Maximum Trunks, Extensions, VMs, PFT ports and MOHs/Pagers

The PBX supports the following number of trunks and extensions.

Trunk	KX-NS300 (Pre-Installed )	KX-NS300 (Maximum)	KX-NS300 w/1 KX-NS320	KX-NS300 w/2 KX-NS320s	KX-NS300 w/3 KX-NS320s
Total Number of Trunks	6	52	82	112	142
Trunk (Physical Trunk Card)	6	36	66	96	126
LCOT	6	12	24	36	48
PRI30	0	30	60	90	120
E1	0	30	60	90	120
Trunk (Virtual Trunk Card)	0	16			
H.323 Trunks	0	16			
SIP Trunks	0	16			
Total Number of Extensions	18	66 (72)	98 (112)	130 (152)	162 (192)
Extension (Physical Extension Card)	18	34 (40)	66 (80)	98 (120)	130 (160)
SLT	16	32	64	96	128
DPT (DXDP)	2 (4)	18 (24)	34 (48)	50 (72)	66 (96)
DPT (other)	0	8	16	24	32
APT	0	8	16	24	32
Extension (Virtual Extension Card)	0	32			
IP-PT and Softphone	0	32			
SIP Extension	0	32			

Trunk		KX-NS300 (Pre-Installed )	KX-NS300 (Maximum)	KX-NS300 w/1 KX-NS320	KX-NS300 w/2 KX-NS320s	KX-NS300 w/3 KX-NS320s
	SIP Phone	0	32			
	KX-UT Series	0	32			
	SIP DECT	0	32			
Total Number of CS		0	20	24	28	32
	DPT-CS (2ch)	2	4	8	12	16
	DPT-CS (8ch)	0	2	4	6	8
	IP-CS	0	16			
	SIP-CS	0	16			
Total Number of PS		128				
Total Number of Doorphone		0	2	4	6	8
	Doorphone	0	2	4	6	8
	Door Opener	0	2	4	6	8
	Sensor	0	2	4	6	8
VM						
	ESVM (ch)	2				
	Built-In UM (ch)	0	24			
	TVM unit	2				
DSS Console		0	8	8	8	8
PFT		2	2	6	10	14
MOH/BGM/EPG		(6)	6	6	6	6
	MOH/BGM	(6)	6	6	6	6
	EPG	(6)	6	6	6	6

## DSP Resources

DSP card provides digital signal processor (DSP) resources, and the PBX uses the resources to perform various PBX operations. The following illustration shows the concept of DSP resource usage. More complex situations may require additional resources, and in some cases the amount of DSP resources required may be less than expected.

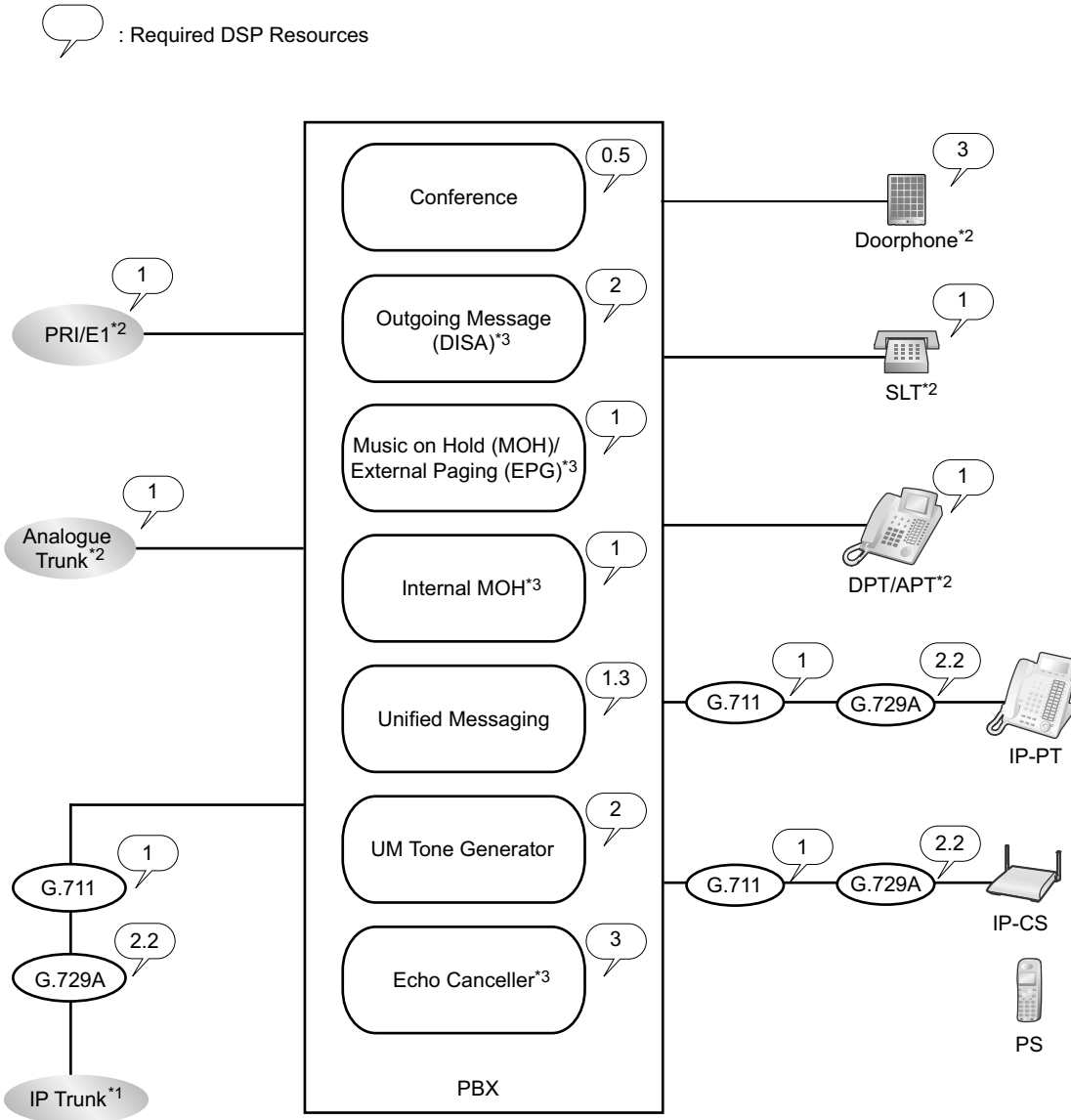

<sup>\*1</sup> Connections that arrive over a stacking connection require the same amount of DSP resources as shown in this example.  
<sup>\*2</sup> DSP resources are used during conversations between legacy trunks/extensions/Doorphones and IP trunks/extensions.  
<sup>\*3</sup> DSP resources are used when IP trunks or IP extensions access these devices.

### Required DSP Resources Assessment

The maximum number of simultaneous calls, operations and features using IP protocols is determined by the DSP card installed in the PBX.

To decide how much resources are required for the PBX, the DSP Resource Advisor can be useful.

#### Note

- Calls cannot be made or received when all of the DSP resources are being used.

- The number of required resources must not exceed the DSP resources installed to the PBX.
- For details about the DSP Resource Advisor, refer to "9.37.1.1 PBX Configuration—[1-5-1] Configuration—DSP Resource—Setting—DSP Resource Advisor" in the PC Programming Manual.
- For information about installing the DSP card, refer to "4.3.3 DSP S Card (KX-NS5110)".
- The number of available DSP resources is not restricted by any activation keys.

### DSP Resource Reservation

DSP resources can be reserved for certain operations to avoid lack of resources for particular operations. The following examples show cases of allocating and reserving DSP resources.

#### Note

For details about reserving DSP resources, refer to "5.5.4.1 DSP Resource Reservation" and "5.5.4.2 DSP Resource Advisor" in the Feature Guide, and "9.37.1.1 PBX Configuration—[1-5-1] Configuration—DSP Resource—Setting—DSP Resource Advisor" in the PC Programming Manual.

#### Example

In this example, the DSP S card (63 DSP resources) is installed and resources are reserved for the following operations:

Operation	Required Resources
VoIP (G.711) Calls	20
Conference Trunks	4
Unified Messaging	6
Two-way Recording Operations	2
OGM Operations	4
UM Tone (Fixed)	2 <sup>1</sup>

<sup>1</sup> Because the system reserves 2 resources for internal system functions, the total amount of available resources indicated will be 2 less than the total resources of the installed card(s).

Reserved Resources  
 $(20 \times 1) + (4 \times 0.5) + \{(6 - 2) \times 1.3\} + (2 \times 2.3) + (4 \times 2) + 2$   
 $= 41.8$

Free Resources  
 $= 63 - 41.8$   
 $= 21.2$

#### Note

This is an example for a KX-NS300 without any stacking Expansion Unit.

## Expandable Resources with Expansion Unit

The following table shows the types of resources that are available when an expansion unit used with a KX-NS300.

#### Notice

When Expansion Units are used with a c, all IP-PTs are registered to the KX-NS300.

### 2.3.3 System Capacity

---

Type	Resource	Availability
Optional Service Card	Physical Card for Legacy Trunks and Extensions	✓
	Virtual Card	– <sup>*1</sup>
	RMT Card	–
	DPH Card	✓
	DSP Card	–
Terminal	DPT/APT/SLT	✓
	PT-interface CS	✓
	PS	✓
	IP-CS/IP-PT/KX-UT Series SIP Phone/SIP-CS	– <sup>*1</sup>
	Doorphone	✓
	IP Softphone	– <sup>*1</sup>
Activation Key	Any Activation key	–

\*1 IP terminals, except for KX-NT265 (software version 2.00 or later only), are registered and controlled by the KX-NS300.

---

## **Section 3**

# ***Information about the Activation Keys***

*This section provides information on activation keys, including how to obtain activation keys.*

## 3.1 Information about the Activation Keys

Activation keys are required to use IP trunks and IP telephones on a private IP network with a KX-NS300. Also, to upgrade the software to use enhanced features, the corresponding activation keys for that feature are required. Some activation keys are provided by default, some are provided free for a limited period, and others are provided separately as activation key files.

### 3.1.1 Type and Maximum Number of Activation Keys

The PBX supports the following type and number of activation keys. The preinstalled activation keys on the mother board are shown with "[ ]".

When the number of preinstalled activation keys is not enough for the desired configuration or when you wish to use enhanced features, additional activation keys in the form of activation key files can be installed using Web Maintenance Console.

**Note**

- Store the downloaded activation key files in your PC or a memory device. They can then be reinstalled in an emergency situation.
- For information about how to obtain the additional activation keys, refer to "3.1.2 Activation Key Code and Key Management System".
- For information about how to install the activation key files using Web Maintenance Console, refer to "5.4.4 Installing Additional Activation Keys".

### System

Model No.	Activation Key Type	Description	Maximum Activation Keys
KX-NSF990	VoIP/UM feature	Allows the use of VoIP/Unified Message (UM) feature.	1 activation key

### IP Trunks

Model No.	Activation Key Type	Description	Maximum IP Trunks
KX-NSM102	2 IP Trunk	Allows the use of 2 IP trunks (H.323/SIP).	64 IP trunks (H.323/SIP) <sup>*1,2</sup>
KX-NSM104	4 IP Trunk	Allows the use of 4 IP trunks (H.323/SIP).	
KX-NSM108	8 IP Trunk	Allows the use of 8 IP trunks (H.323/SIP).	
KX-NSM116	16 IP Trunk	Allows the use of 16 IP trunks (H.323/SIP).	

\*1 You need to set the number of installed activation keys to be used for H.323 trunks through system programming. By default, all installed activation keys will be used for SIP trunks.

\*2 The maximum number of IP trunks for H.323 is 32.



## IP Telephone Capacity

Model No.	Activation Key Type	Description	Maximum IP Telephones
KX-NSM201	1 IPSoftphone/IP PT	Allows the use of 1 IP-PT/IP softphone/KX-UT series SIP phone.	Total 128 IP-PTs/IP softphones/KX-UT series SIP phones <sup>1</sup>
KX-NSM205	5 IPSoftphone/IP PT	Allows the use of 5 IP-PTs/IP softphones/KX-UT series SIP phones.	
KX-NSM210	10 IPSoftphone/IP PT	Allows the use of 10 IP-PTs/IP softphones/KX-UT series SIP phones.	
KX-NSM220	20 IPSoftphone/IP PT	Allows the use of 20 IP-PTs/IP softphones/KX-UT series SIP phones.	
KX-NSM501	1 IP PT	Allows the use of 1 IP-PT/ KX-UT series SIP phone.	Total 128 IP-PTs/ KX-UT series SIP phones [4 IP-PTs/KX-UT series SIP phones] <sup>2</sup>
KX-NSM505	5 IP PT	Allows the use of 5 IP-PTs/ KX-UT series SIP phones.	
KX-NSM510	10 IP PT	Allows the use of 10 IP-PTs/ KX-UT series SIP phones.	
KX-NSM520	20 IP PT	Allows the use of 20 IP-PTs/ KX-UT series SIP phones.	
KX-NSM701	1 SIP Extension	Allows the use of 1 IP Conferencing Phone/third party SIP phone.	Total 128 IP Conferencing Phones/ third party SIP phones
KX-NSM705	5 SIP Extension	Allows the use of 5 IP Conferencing Phones/third party SIP phones.	
KX-NSM710	10 SIP Extension	Allows the use of 10 IP Conferencing Phones/third party SIP phones.	
KX-NSM720	20 SIP Extension	Allows the use of 20 IP Conferencing Phones/third party SIP phones.	

<sup>1</sup> You can set how many IP softphones can be used with the installed activation keys through system programming. By default, only IP softphones can be used with the installed activation keys.

<sup>2</sup> The capacity given in [square brackets] shows the number of activation keys preinstalled on the mother board.

## Networking

Model No.	Activation Key Type	Description	Maximum Activation Keys
KX-NSN002	QSIG Network	Allows the use of enhanced QSIG network features (NDSS, Centralised Voice Mail, etc.).	1 activation key

### 3.1.1 Type and Maximum Number of Activation Keys

---

#### Feature Guide References for Related Features of Activation Keys

##### QSIG Network

- 4.2.1.4 Common Extension Numbering for 2 PBXs
- 4.2.2.2 Common Extension Numbering for Multiple PBXs
- 4.2.5 QSIG Enhanced Features
- 4.2.5.1 Network Direct Station Selection (NDSS)
- 4.2.5.2 Centralised Voice Mail

### Unified Messaging System (Features)

Model No.	Activation Key Type	Description	Maximum Activation Keys
KX-NSU002	Two-way REC Control	Allows a manager/administrator to use the Automatic Two-way Recording feature to record other users.	1 activation key
KX-NSU003	Message Backup	Allows the automatic backup of messages.	1 activation key

#### Feature Guide References for Related Features of Activation Keys

##### Two-way REC Control

- 3.2.1.4 Automatic Two-way Recording for Manager

##### Message Backup

- 3.1.2.5 System Backup/Restore

### Unified Messaging System (Unified Messaging Ports)

Model No.	Activation Key Type	Description	Maximum Unified Messaging Ports
KX-NSU102	2 UM Port	Allows the use of 2 Unified Messaging ports.	24 Unified Messaging ports [2 Unified Messaging ports]
KX-NSU104	4 UM Port	Allows the use of 4 Unified Messaging ports.	

#### Feature Guide References for Related Features of Activation Keys

- 3.1.2.5 System Backup/Restore

## Unified Messaging System (Mailbox)

Model No.	Activation Key Type	Description	Maximum Mailboxes
KX-NSU201	UM/E-mail 1 User	Allows the use of an e-mail (IMAP4) client and e-mail notification (voice) for 1 user.	500 mailboxes
KX-NSU205	UM/E-mail 5 Users	Allows the use of an e-mail (IMAP4) client and e-mail notification (voice) for 5 users.	
KX-NSU210	UM/E-mail 10 Users	Allows the use of an e-mail (IMAP4) client and e-mail notification (voice) for 10 users.	
KX-NSU220	UM/E-mail 20 Users	Allows the use of an e-mail (IMAP4) client and e-mail notification (voice) for 20 users.	
KX-NSU299	UM/E-mail All Users	Allows the use of an e-mail (IMAP4) client and e-mail notification (voice) up to the system's limit.	

### Feature Guide References for Related Features of Activation Keys

- 3.2.1.28 Message Waiting Notification—E-mail Device
- 3.3.1 Integration with Microsoft Outlook
- 3.3.2 IMAP Integration

## Unified Messaging System (Two-way Recording/Two-way Transfer Users)

Model No.	Activation Key Type	Description	Maximum Users
KX-NSU301	2way REC 1 User	Allows the use of Two-way Recording/Two-way Transfer for 1 user.	288 users
KX-NSU305	2way REC 5 Users	Allows the use of Two-way Recording/Two-way Transfer for 5 users.	
KX-NSU310	2way REC 10 Users	Allows the use of Two-way Recording/Two-way Transfer for 10 users.	
KX-NSU320	2way REC 20 Users	Allows the use of Two-way Recording/Two-way Transfer for 20 users.	
KX-NSU399	2way REC All Users	Allows the use of Two-way Recording/Two-way Transfer up to the system's limit.	

### 3.1.1 Type and Maximum Number of Activation Keys

---

#### Feature Guide References for Related Features of Activation Keys

3.2.2.30 Two-way Record/Two-way Transfer

### Cellular Phone Extension

Model No.	Activation Key Type	Description	Maximum Cellular Phone Extensions
KX-NSE101	1 Mobile User	Allows the use of 1 cellular phone extension.	288 cellular phone extensions
KX-NSE105	5 Mobile Users	Allows the use of 5 cellular phone extensions.	
KX-NSE110	10 Mobile Users	Allows the use of 10 cellular phone extensions.	
KX-NSE120	20 Mobile Users	Allows the use of 20 cellular phone extensions.	

#### Feature Guide References for Related Features of Activation Keys

- 2.2.2.3 Outside Destinations in Incoming Call Distribution Group
- 2.3.2 Call Forwarding (FWD)
- 2.16.1 Direct Inward System Access (DISA)
- 2.27.1 Cellular Phone Features—SUMMARY
- 4.2.6 Network ICD Group
- 4.2.6.1 PS Roaming by Network ICD Group

### Communication Assistant (CA) User

Model No.	Activation Key Type	Description	Maximum Activation Keys
KX-NSA010	CA Thin Client	Allows the use of CA Client in a thin-client environment.	1
KX-NSA020	CSTA Multiplexer	Allows the use of CSTA Multiplexer.	4

Model No.	Activation Key Type	Description	Maximum Activation Keys
KX-NSA201	CA Pro 1 user	Allows the use of CA Client Pro for 1 user. <sup>*1</sup>	240 <sup>*2</sup> users without CA server (Max. 288 <sup>*3</sup> users with CA server)
KX-NSA205	CA Pro 5 users	Allows the use of CA Client Pro for 5 users. <sup>*1</sup>	
KX-NSA210	CA Pro 10 users	Allows the use of CA Client Pro for 10 users. <sup>*1</sup>	
KX-NSA240	CA Pro 40 users	Allows the use of CA Client Pro for 40 users. <sup>*1</sup>	
KX-NSA249	CA Pro 128 users	Allows the use of CA Client Pro for 128 users. <sup>*1</sup>	
KX-NSA301	CA Supervisor	Allows the use of CA Client Supervisor for 1 user.	
KX-NSA401	CA Console	Allows the use of CA Client Operator Console for 1 user.	
KX-NSA901	CA Network 1 user	Allows the use of CA Server network features for 1 user.	
KX-NSA905	CA Network 5 users	Allows the use of CA Server network features for 5 users.	
KX-NSA910	CA Network 10 users	Allows the use of CA Server network features for 10 users.	
KX-NSA940	CA Network 40 users	Allows the use of CA Server network features for 40 users.	
KX-NSA949	CA Network 128 users	Allows the use of CA Server network features for 128 users.	

<sup>\*1</sup> A maximum of 288 CA users can be registered. However, CA Server is necessary to register more than 240 CA users.

<sup>\*2</sup> The maximum number of Supervisor users without CA server is 4 users.

<sup>\*3</sup> The maximum number of Operator Console and Supervisor users combined when CA Server is used is 128 users.

## CTI Licence

Model No.	Activation Key Type	Description	Maximum Activation Keys
KX-NSF101	CTI interface	Allows the use of the 3rd Party CTI interface.	1

### Feature Guide References for Related Features of Activation Keys

2.26.1 Computer Telephony Integration (CTI)

## Preinstalled Activation Keys in the Mother Board

### Preinstalled activation keys with no expiration date

The following type and number of activation keys are preinstalled on the mother board.

### 3.1.1 Type and Maximum Number of Activation Keys

Activation Key	Activated Features
CA Basic-Express	No Limit
IP Proprietary Telephone (ch)	4 IP-PTs/KX-UT series SIP phones
UM Port (ch)	2 Unified Messaging ports

#### Example: Preinstalled Activation Keys in the Mother Board

Activated feature	Pre-installed	Activation key	Features in total
IP Trunk (ch)	0	16	16
IP Proprietary Telephone/IP Soft	0	20	20
IP Proprietary Telephone (ch)	8	20	28
SIP Extension (ch)	0	20	20

#### Preinstalled activation keys for free trial

The following activation keys are preinstalled on the mother board for the 60-days free trial. They will expire 60 days after pressing the **Activate Pre-installed Activation key** button to begin the free trial.

Activation Key	Activated Features
Two-way Recording Control	Automatic Two-way Recording feature
Message Backup	Automatic backup of messages
UM/E-mail (128 user)	128 mailboxes
Two-Way Recording (30 users)	30 Two-way Recording/Two-way Transfer users
Mobile Extension (30 users)	30 cellular phone extensions
CA PRO (128 users)	128 CA Pro users
CA Supervisor (1 user)	1 CA Supervisor user
CA Operator Console (1 user)	1 CA Console user
CA Thin Client Server	Use CA in a thin-client environment
CSTA Multiplexer	Multiplexing for CSTA connections
CTI interface	3rd Party CTI interface
Call Centre Feature Enhancement	Built-in ACD Report, Announcement of waiting number for queuing

### Activation Key Installation Example

The following illustration shows an example of when using 16 SIP trunks, 16 H.323 trunks, 40 IP-PTs, 20 IP softphones, and 20 KX-UT series SIP phones on a private IP network using the mother board.

Example:

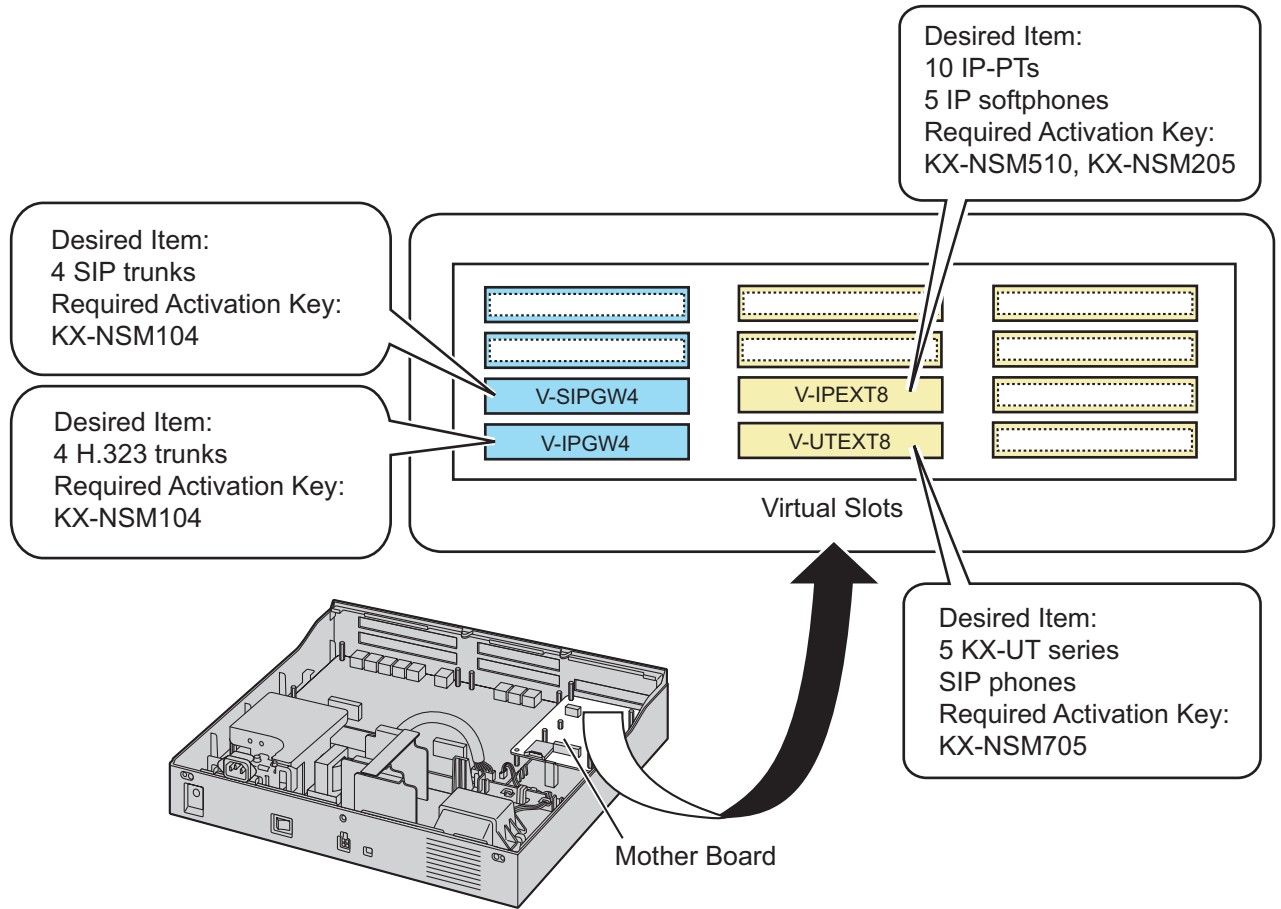

## 3.1.2 Activation Key Code and Key Management System

To obtain additional activation keys, you need to purchase the appropriate activation key codes and access the Key Management System. You can download the activation keys as an activation key file from the Key Management System.

To download the activation keys, enter the MPR ID number shown on the back of the main unit, and activation key number and registration ID provided on each activation key code.

For information about the type of activation key codes available, refer to "3.1.1 Type and Maximum Number of Activation Keys".

For details about installing the downloaded activation key file(s) in the PBX memory using Web Maintenance Console, refer to "5.4.4 Installing Additional Activation Keys".

#### **Note**

- You can only download the activation key file once using the activation key number and registration ID provided on the activation key code.
- Up to 8 activation keys can be downloaded as one activation key file.
- Up to 997 activation key files can be installed in the PBX memory.
- It is possible to send the activation key file to a specified e-mail address at the same time as downloading it to a PC.
- Make sure to backup the downloaded activation key files on your PC.
- When the mother board has to be replaced due to a system malfunction, the MPR ID for the mother board is no longer valid. In this case, you need a temporary activation key for maintenance purposes. The temporary activation key can only be used for a limited time period, and can be downloaded from the Key Management System in the same way as downloading activation key files.



### 3.1.3 Using CTI Applications

To use CTI applications with the KX-NS300, KX-NSF101 (CTI interface) is required. One KX-NSF101 supports one CTI application. However, Communication Assistant (CA) Server does not require KX-NSF101. In the example below, one KX-NSF101 is required for using one CTI application.

#### Example 1

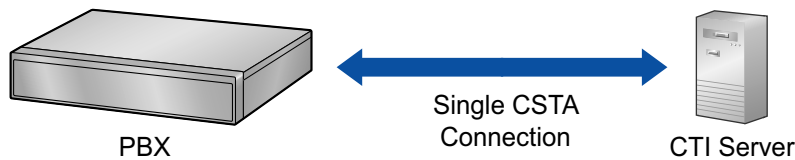

In the example below, an activation key is not required to use CA Server.

#### Example 2

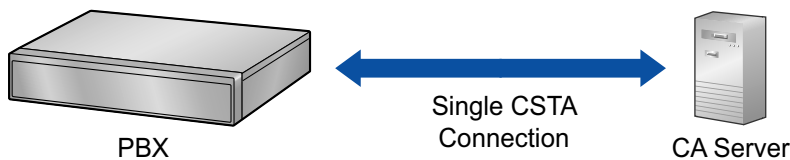

To use 2 or more CTI applications, the CSTA Multiplexer application is required, along with one KX-NSA020 (CSTA Multiplexer) for each CTI application. KX-NSF101 is included in KX-NSA020. Therefore, when KX-NSA020 is installed, KX-NSF101 is not required.

In the example below, three KX-NSA020 are required for three CTI applications. (CA Server does not require a KX-NSA020.)

#### Example 3

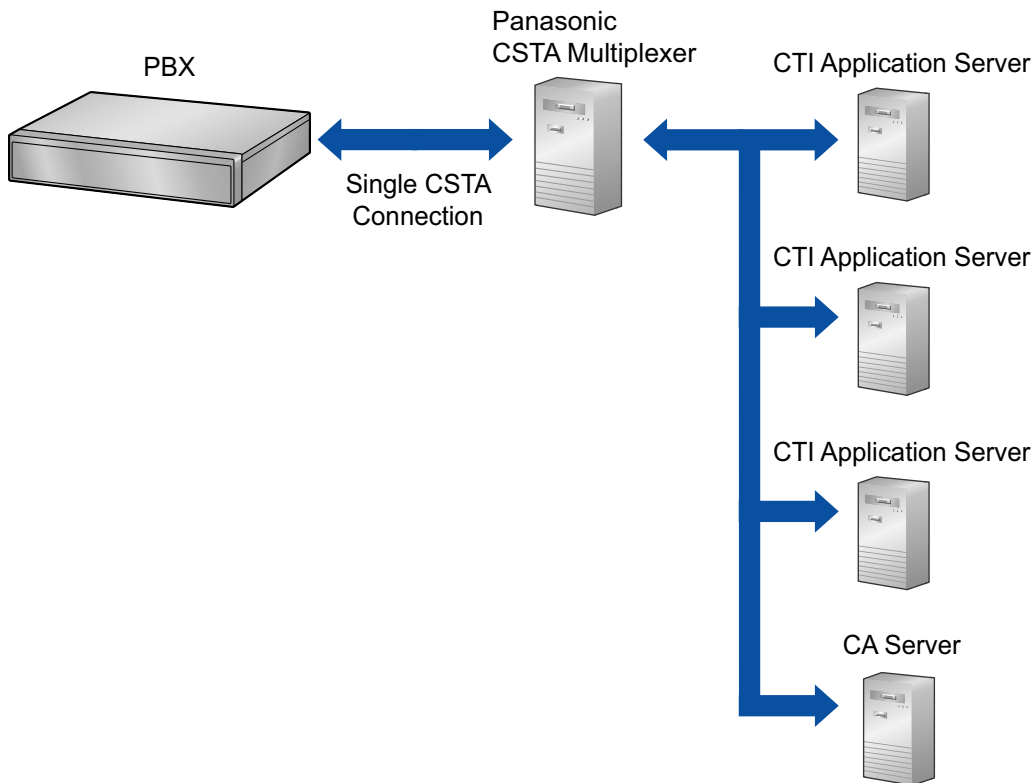

#### Note

- Up to 4 CTI application servers can be used at the same time when using a CSTA multiplexer.
- An Activation Key for Multiple CSTA Connection (KX-NSA020) is required for each CTI application.
- When a 3rd party CSTA multiplexer is used, a CTI interface activation key (KX-NSF101) is required for the CSTA connection. (In this case, Activation Key for Multiple CSTA Connection [KX-NSA020] is not required.)
- For details regarding KX-NSF101, refer to "CTI Licence" in "3.1.1 Type and Maximum Number of Activation Keys".
- For details regarding KX-NSA020, refer to "Communication Assistant (CA) User" in "3.1.1 Type and Maximum Number of Activation Keys".

---

## **Section 4**

# **Installation**

*This section describes the procedures to install the PBX. Detailed instructions for planning the installation site, installing the main unit and optional service cards, and cabling of peripheral equipment are provided. Further information on peripheral equipment installation is included.*

## 4.1 Before Installation

### 4.1.1 Before Installation

Please read the following notes concerning installation and connection before installing the PBX and terminal equipment.

Be sure to comply with all applicable laws, regulations, and guidelines.

#### **Notice**

Panasonic assumes no responsibility for injuries or property damage resulting from failures arising out of improper installation or operation inconsistent with this documentation.

### Safety Installation Instructions

#### **WARNING**

**When installing telephone wiring, basic safety precautions should always be followed to reduce the risk of fire, electric shock and injury to persons, including the following:**

- **Never install telephone wiring during a lightning storm.**
- **Never install telephone jacks in wet locations unless the jack is specifically designed for wet locations.**
- **Never touch uninsulated telephone wires or terminals unless the telephone line has been disconnected at the network interface.**
- **Use caution when installing or modifying telephone lines.**
- **Anti-static precautions should be taken during installation.**

### Installation Precautions

The PBX is suitable for mounting on a 19-inch rack, mounting on a wall, or placing on a desktop, and should be installed in a location where it is accessible for inspections and maintenance.

To prevent malfunction, noise, or discolouration, follow the instructions below:

#### **WARNING**

**Do not install the system in the following locations:**

- **Areas where shocks or vibrations are frequent or strong. Such activity may lead to the product falling over and causing injury, or may impair the product's performance.**
- **Areas with high amounts of dust. High amounts of dust can lead to fire or electric shock, and impair the performance of the product.**

#### **CAUTION**

Do not install the system in the following locations:

- In direct sunlight and hot, cold, or humid places. (Temperature range: 0 °C to 40 °C)
- Areas where sulphuric gases may be present, such as near thermal springs.
- Near devices that generate high frequencies, such as sewing machines or electric welders.
- Locations where other objects will obstruct the area around the PBX. Be especially careful to leave at least 5 cm to the sides of the PBX for ventilation.
- Locations where condensation can occur.

#### **Notice**

Do not install the system in the following locations:

- On or near computers, or other office equipment, as well as microwave ovens or air conditioners. (It is preferable not to install the system in the same room as the above equipment.)
- Within 1.8 m of radios and televisions. (Both the PBX and PTs should be at least 1.8 m away from such devices.)

Do not perform the following:

- Do not block the openings of the PBX.
- Do not stack up the optional service cards.

## Wiring Precautions

Be sure to follow these instructions when wiring the unit:

### **CAUTION**

- Avoid using the same AC outlet for computers and other office equipment, as noise generated by such equipment may hamper system performance or interrupt the system.
- Unplug the system from its power source when wiring, and plug the system back in only after all wiring is completed.
- Trunks should be installed with surge protectors. For details, refer to "4.2.11 Surge Protector Installation".

### **Notice**

- Use 1-pair telephone cables when connecting SLTs, data terminals, answering machines, computers, etc.
- Mis-wiring may cause the PBX to operate improperly. Refer to "Section 4 Installation" when wiring the system.
- If an extension does not operate properly, disconnect the telephone from the extension line and connect it again, or turn off the PBX using the power switch, then turn it on again.
- Use twisted pair cable for trunk connection.
- To prevent signal noise from interfering with the performance of the product, do not run unshielded telephone cables near AC power cables, computer cables, AC power sources, etc. When running cables near other noise-generating devices or cables, use shielded telephone cables or shield the telephone cables with metal tubing.

## Preparing the Network Environment

Be sure to prepare your network's environment for the installation of the PBX according to the intended PBX networking configuration. For details about PBX network configurations, refer to "Section 8 Networking Information".

## 4.2 Installation of the PBX

### 4.2.1 Unpacking

#### **KX-NS300**

Unpack the box and check the items below:

- Main unit
- CD-ROM(s)<sup>\*1</sup>
- AC power cord
- Hook clip
- Screw x 3 (For Wall Mounting)
- Washer x 3 (For Wall Mounting)

<sup>\*1</sup> The number of included CD-ROMs varies according to the country/area.

#### **KX-NS320**

Unpack the box and check the items below:

- Expansion unit
- CD-ROM(s)<sup>\*1</sup>
- AC power cord
- Hook clip
- Ferrite core x 2
- Screw x 3 (For Wall Mounting)
- Washer x 3 (For Wall Mounting)

<sup>\*1</sup> The number of included CD-ROMs varies according to the country/area.

## 4.2.2 Names and Locations

### KX-NS300

Front

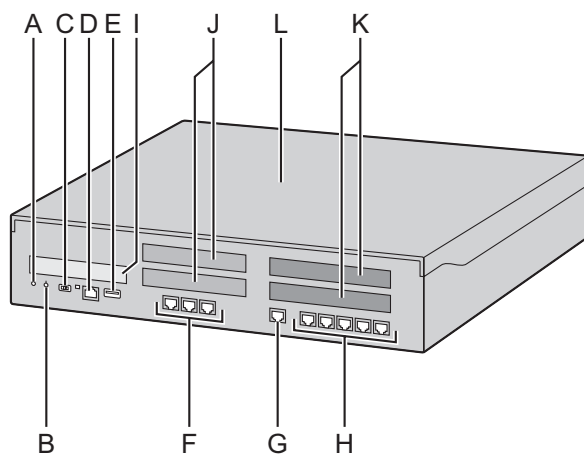

Back/Inside

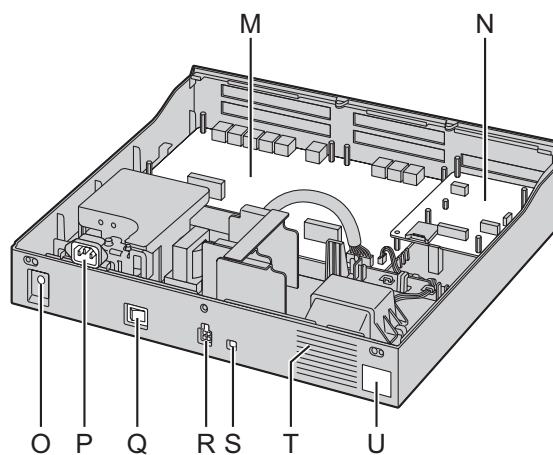

- A.** STATUS Indicator
- B.** PBX MODE indicator (Unused)
- C.** System Mode Switch
- D.** LAN Port
- E.** USB Port
- F.** LCOT Ports
- G.** DPT Port
- H.** SLT Ports
- I.** EXP-M slot
- J.** Trunk/Doorphone Free Slot
- K.** Extension Free Slot
- L.** Top Cover
- M.** Sub Board
- N.** Main Board
- O.** FG Terminal
- P.** AC Inlet
- Q.** Power Switch
- R.** External Battery
- S.** Battery Switch
- T.** FAN
- U.** MPR ID

## 4.2.2 Names and Locations

### KX-NS320

Front

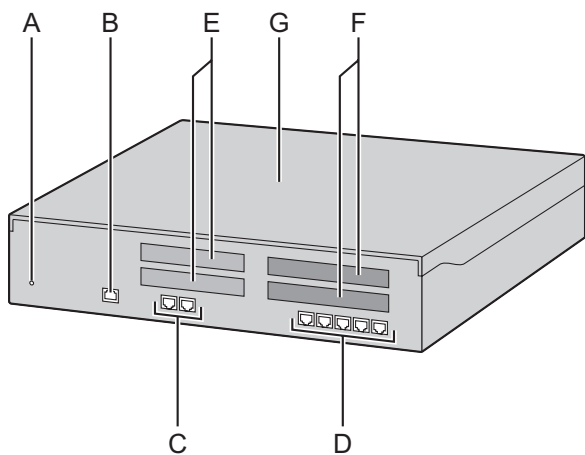

Back/Inside

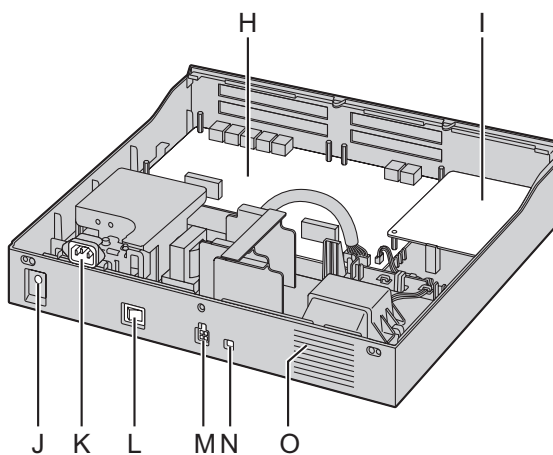

- A.** STATUS Indicator
- B.** EXT-S Port
- C.** PFT Port
- D.** SLT Slot
- E.** Trunk/Doorphone Free Slot
- F.** Extension Free Slot
- G.** Top Cover
- H.** Sub Board
- I.** Main Board
- J.** FG Terminal
- K.** AC Inlet
- L.** Power Switch
- M.** External Battery
- N.** Battery Switch
- O.** FAN



## 4.2.3 Opening/Closing the Top Cover

### Opening the Top Cover

KX-NS300/KX-NS320

#### **CAUTION**

When opening the top cover, the power switch must be turned off.

1. Confirm that the power switch is turned off and pull the power cable.

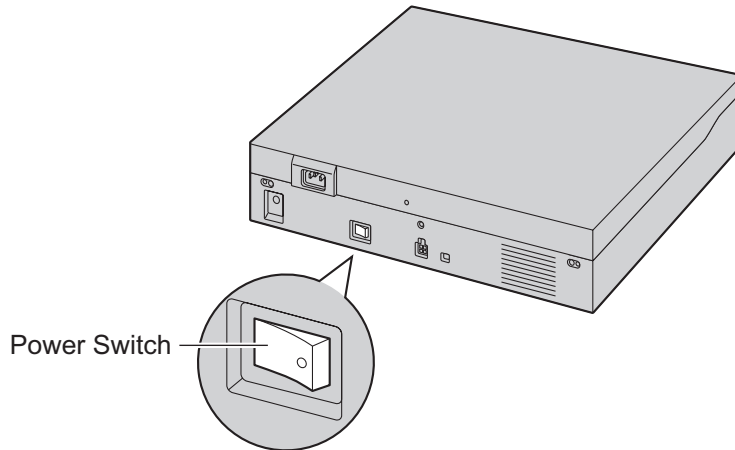

#### **Note**

In order to turn off the PBX's power, a system shutdown using Web Maintenance Console must first be performed. For details, refer to "5.4 System Control—System Shutdown" in the PC Programming Manual.

2. Turn the screws anticlockwise to loosen.

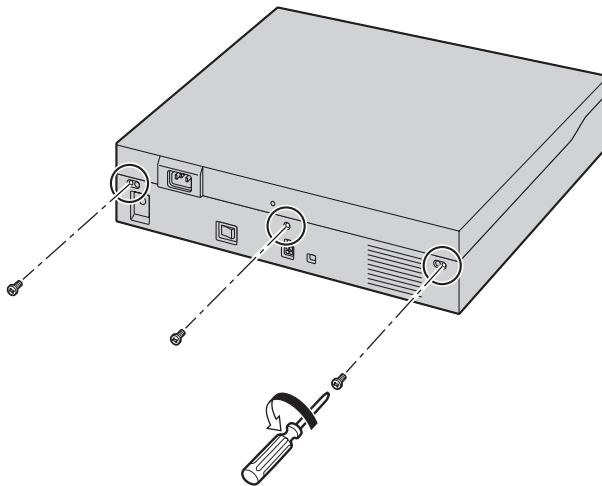

### 4.2.3 Opening/Closing the Top Cover

---

3. Slide the top cover then lift it off.

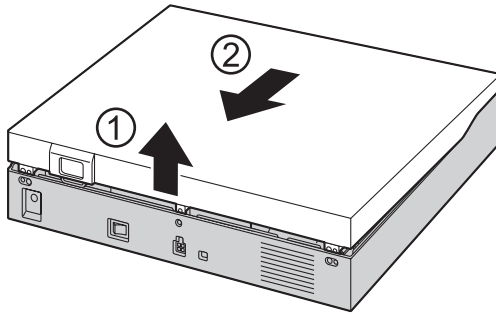

### Closing the Top Cover

1. Place the top cover onto the PBX. Then slide the top cover until it closes properly.

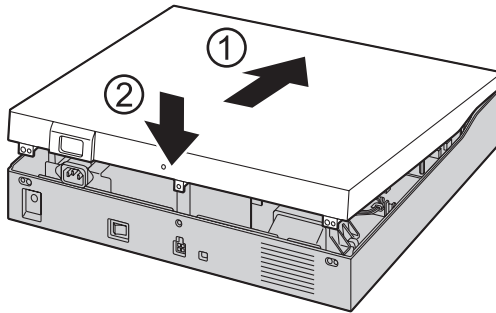

2. Turn the screws clockwise to tighten.

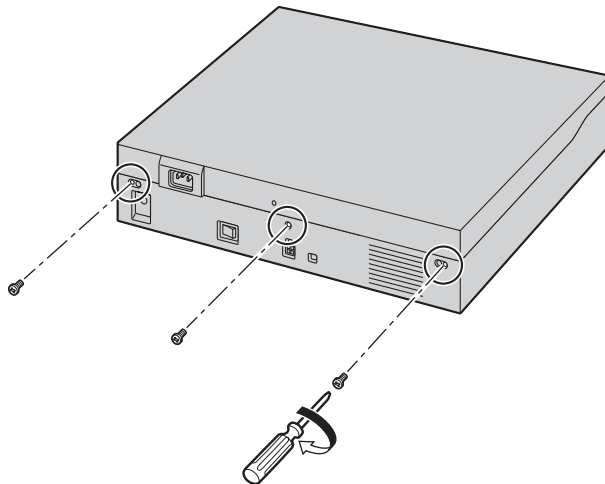

### **CAUTION**

For safety reasons, close the top cover and tighten the screws before operating the PBX.

## 4.2.4 Frame Earth Connection

### KX-NS300/KX-NS320

1. Loosen the screw.
2. Insert an earthing wire (user-supplied).
3. Tighten the screw.
4. Connect the earthing wire to earth.

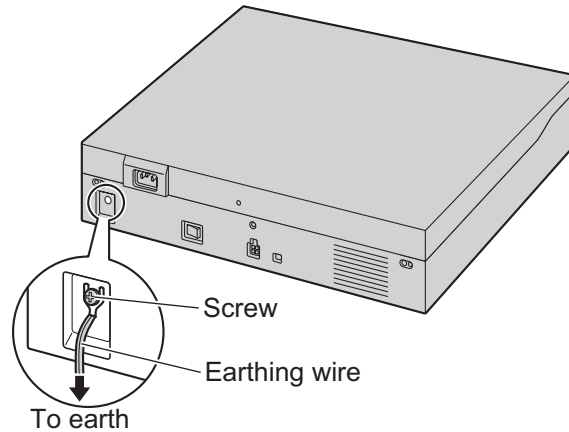

### **WARNING**

- Proper earthing (connection to earth) is very important to reduce the risk to the user of electrocution or to protect the PBX from the bad effects of external noise in the case of a lightning strike.
- The earthing wire of the AC cable has an effect against external noise and lightning strikes, but it may not be enough to protect the PBX and to ensure electromagnetic compatibility. A permanent connection between earth and the earth terminal of the PBX must be made.

### **CAUTION**

For earthing wire, green-and-yellow insulation is required, and the cross-sectional area of the conductor must be more than 0.75 mm<sup>2</sup> or 18 AWG.

### **Notice**

Be sure to comply with applicable local regulations (e.g., laws, guidelines).

## 4.2.5 Installing/Removing the Optional Service Cards

### **CAUTION**

- Before touching the product (PBX, cards, etc.), discharge static electricity by touching ground or wearing an earthing strap. Failure to do so may cause the PBX to malfunction due to static electricity.
- When installing or removing the optional service cards, the power switch must be turned off.
- When installing or removing the optional service cards, do not put pressure on any parts of the mother board. Doing so may result in damage to the PBX.

### **Note**

Make sure the AC power cord is not connected to the AC inlet of the PBX.

## Installing a DSP Card in a DSP Card Slot

1. Place the front end of the card under the hook, and then lower the rear end of the card so that the holes of the card are aligned with the screw holes.

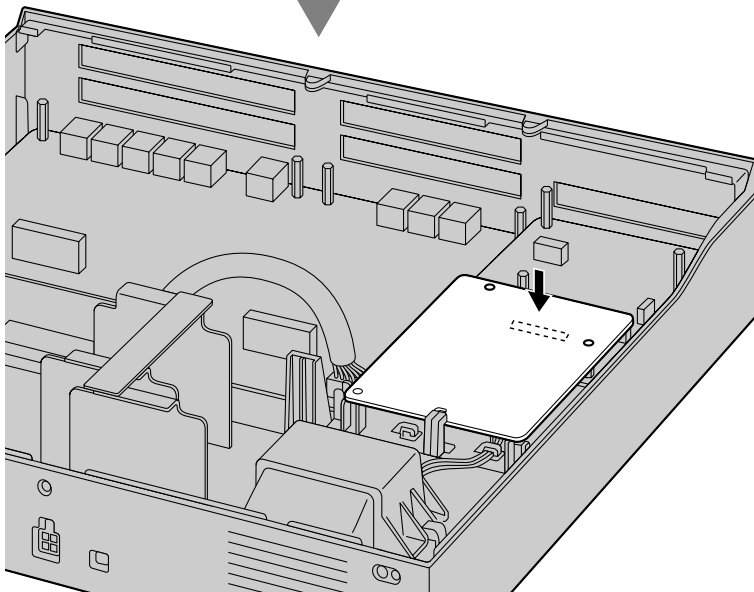
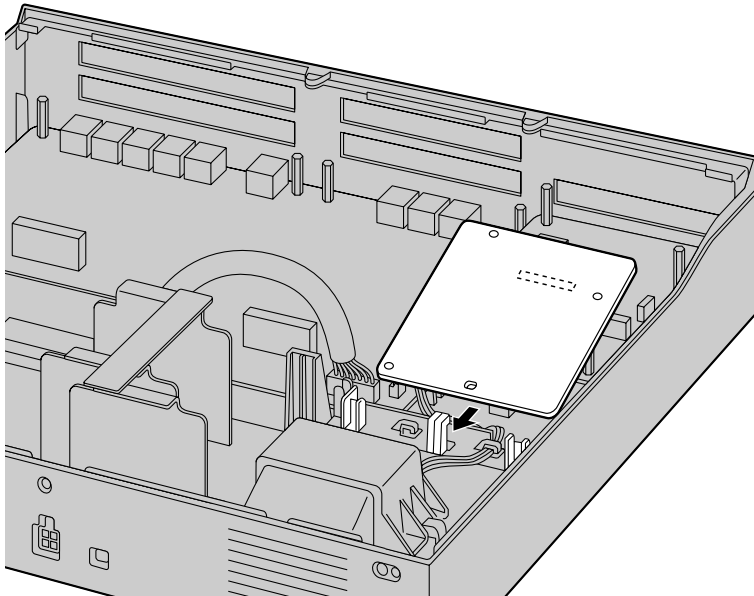

#### 4.2.5 Installing/Removing the Optional Service Cards

---

2. Insert the screws into the holes on the card, and tighten the screws to secure the card.

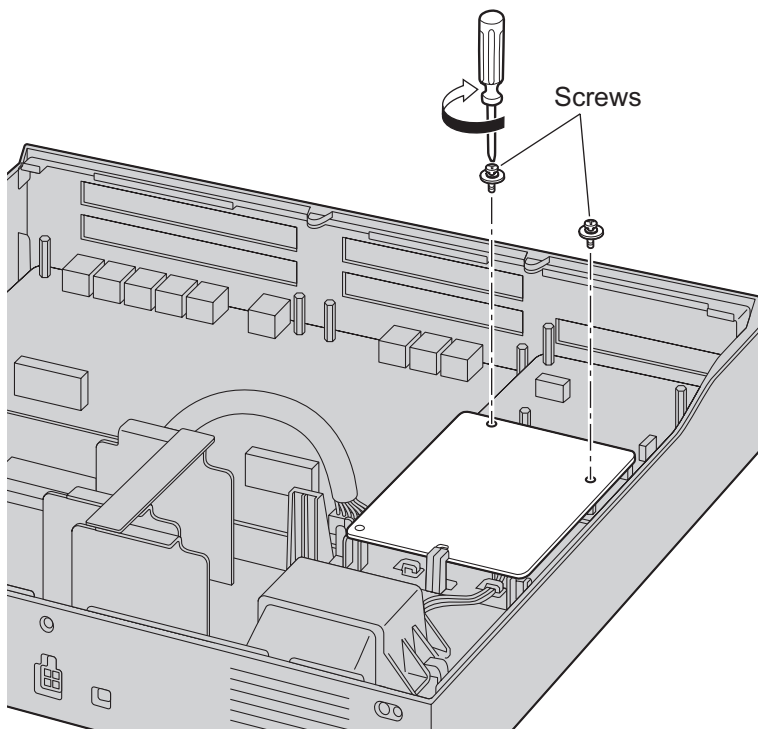

#### Removing a DSP Card Installed in the DSP Card Slot

1. Loosen and remove the screws.

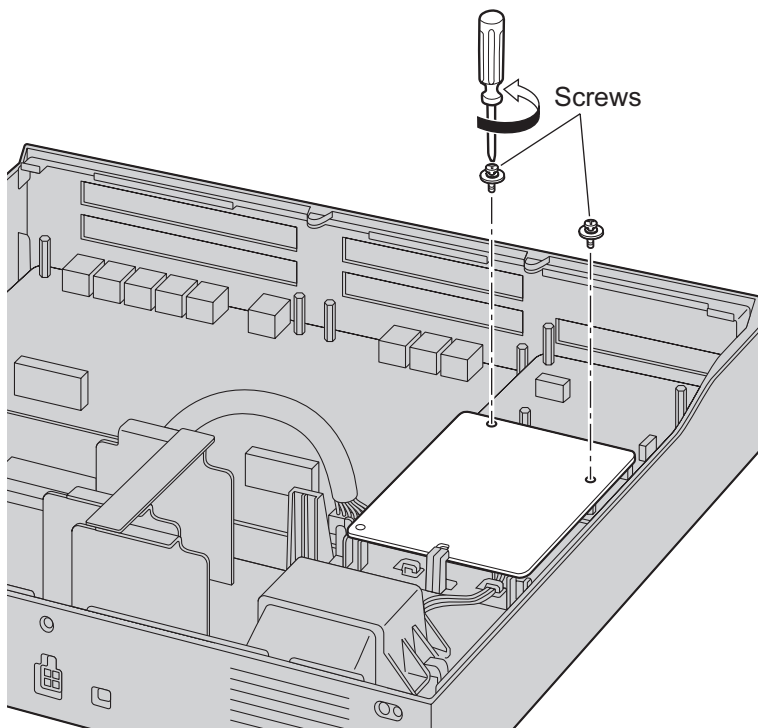

2. Holding the rear end of the card, pull the card in the direction of the arrows.

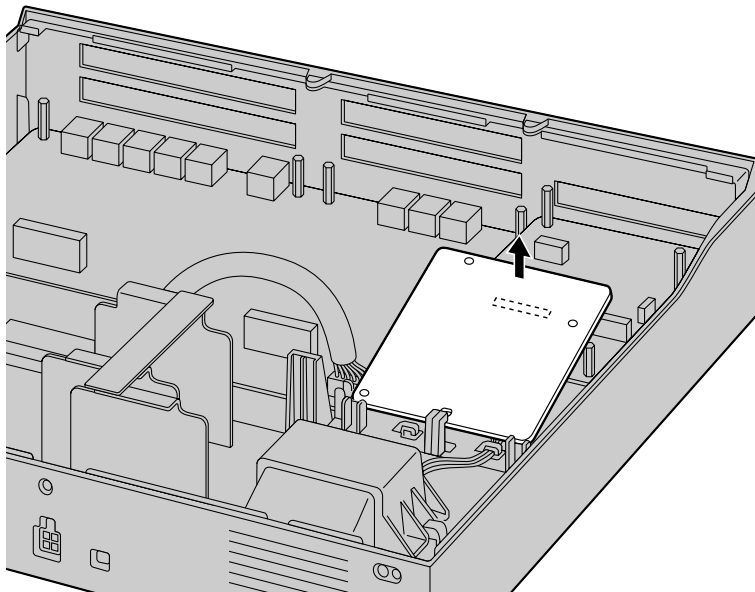

KX-NS300

KX-NS320

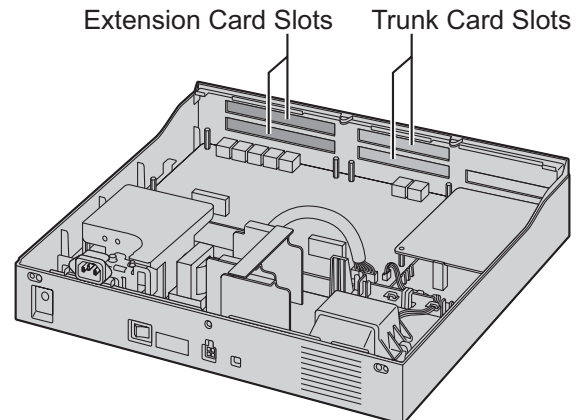
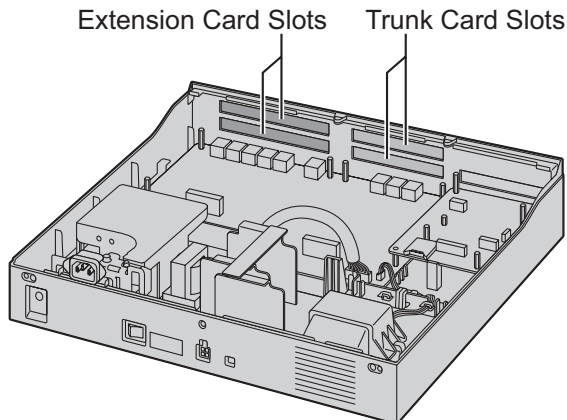

## Installing an Optional Service Card in the Free Slot

In the Main Unit KX-NS300 and Expansion Unit KX-NS320, there are Free slot for Trunk/Doorphone cards and Free slot for Extension cards. In Free slot for Trunk/Doorphone card, you can install the following cards: LCOT6, PRI30/E1 Doorphone card. In Free slot for Extension card, you can install the following cards: DHLC4, DLC8, DLC16, MCSLC8, MCSLC16. For details, refer to the description of each optional service card in "4.5 Physical Trunk and Extension Cards" and "4.7 The Doorphone Card".

#### 4.2.5 Installing/Removing the Optional Service Cards

---

1. Remove the front cover plate for the Free slot.

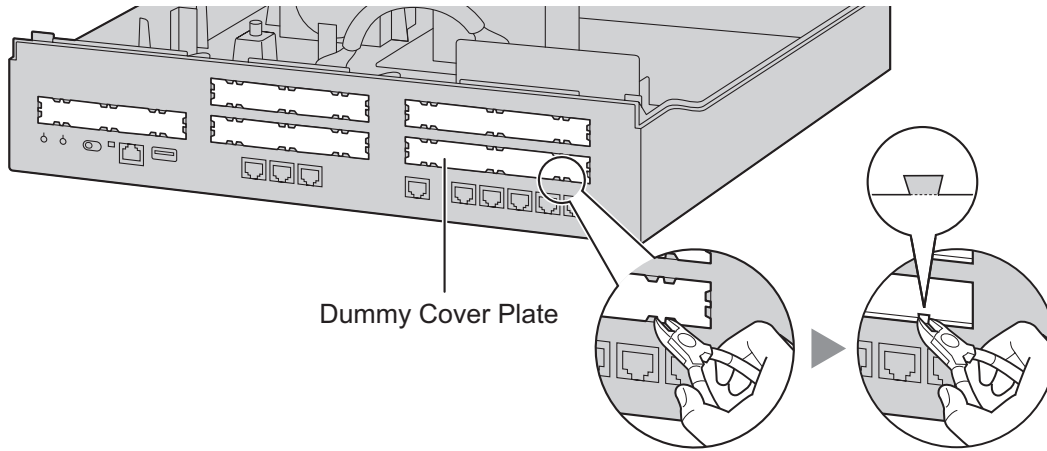



2. Position the card in the open slot, making sure that the tabs on the both sides of the card fit into place. Then, holding the card firmly in place, lower the rear end so that the holes of the card are aligned with the screw holes.

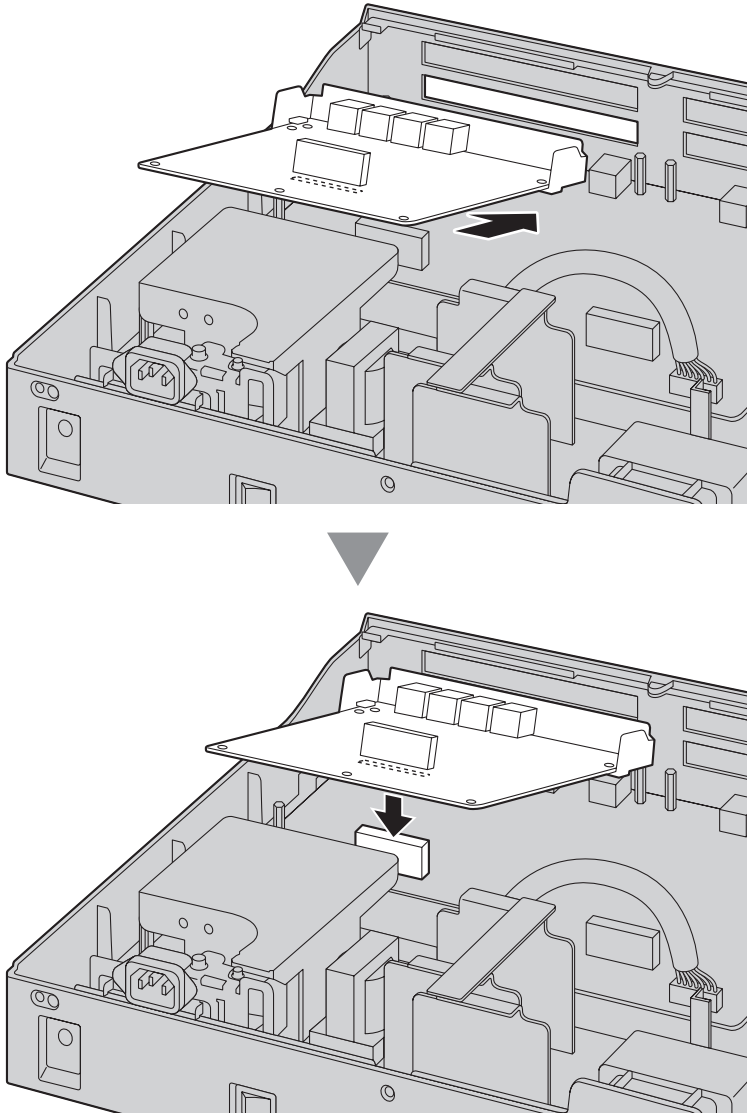

#### 4.2.5 Installing/Removing the Optional Service Cards

---

3. Insert the spacers into the holes on the card, and tighten the spacers to secure the card.

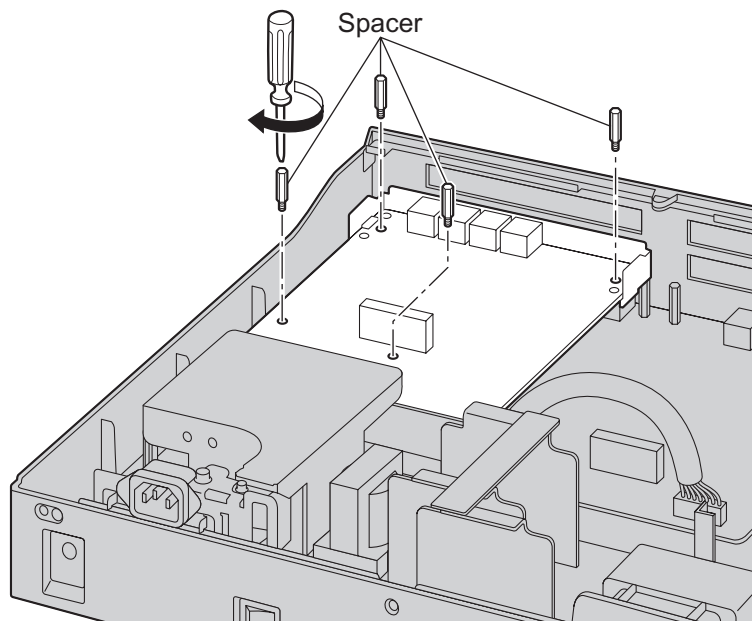

**Note**

When using larger sized cards with smaller sized cards, install the larger sized cards in the bottom.

4. Connect cables to appropriate ports of the card. For details about pin assignments, refer to the appropriate section in "4.5 Physical Trunk and Extension Cards".

**Note**

Make sure to connect cables after installing the card in the PBX, not before.

## Removing Optional Service Card from the Free Slot

1. Loosen and remove the spacers.

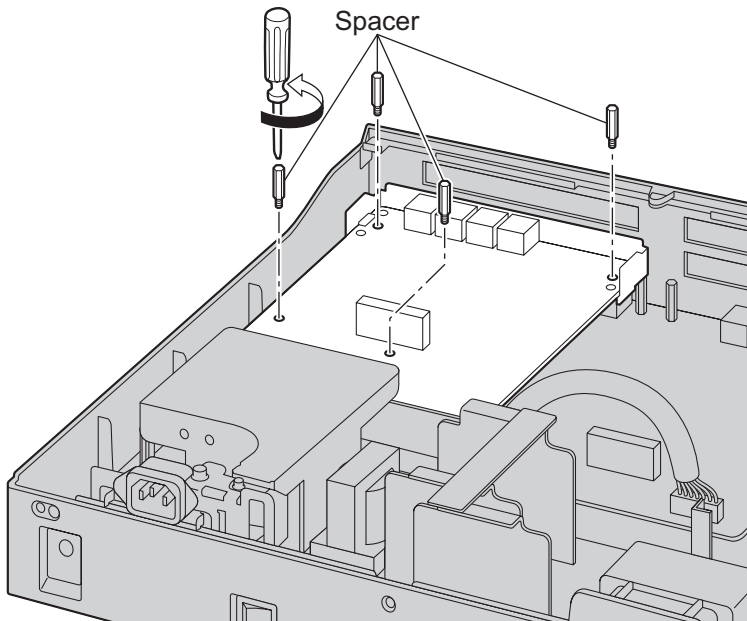

2. Holding the rear end of the card, pull the card in the direction of the arrows.

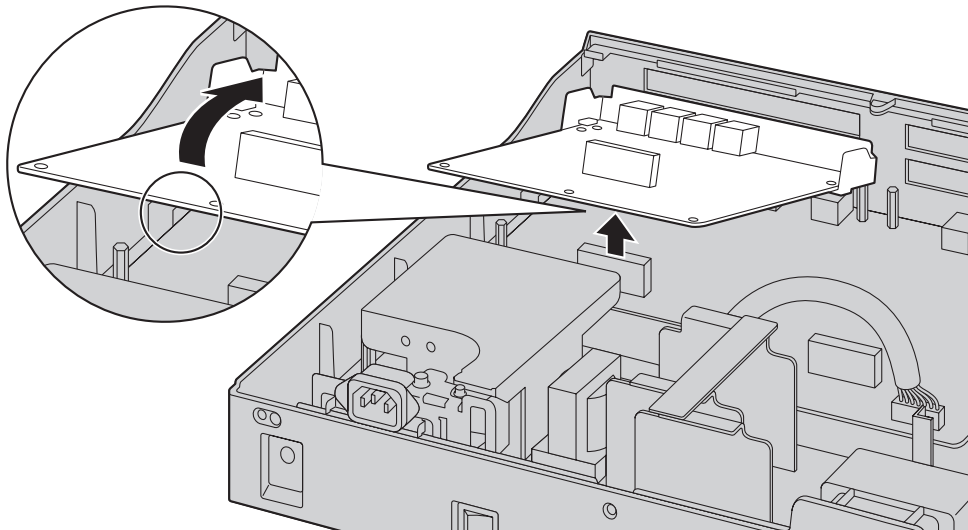

## Installing the EXP-M Card in the EXP-M Card slot

1. Remove the front cover plate for the EXP-M card.

Dummy Cover Plate

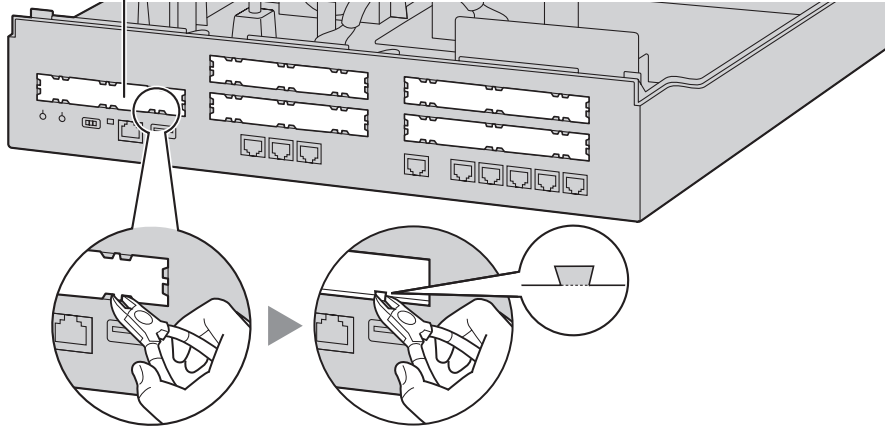

2. Position the card in the EXP-M card slot, making sure that the tabs on the both sides of the card fit into place. Then, holding the card firmly in place, lower the rear end so that the holes of the card are aligned with the screw holes.

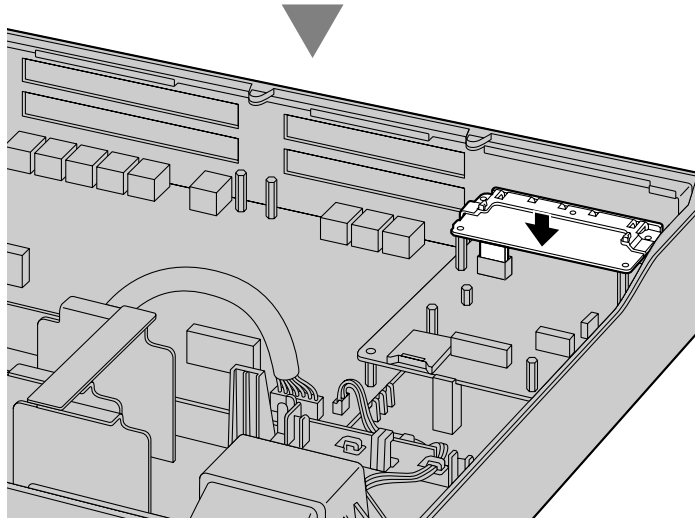
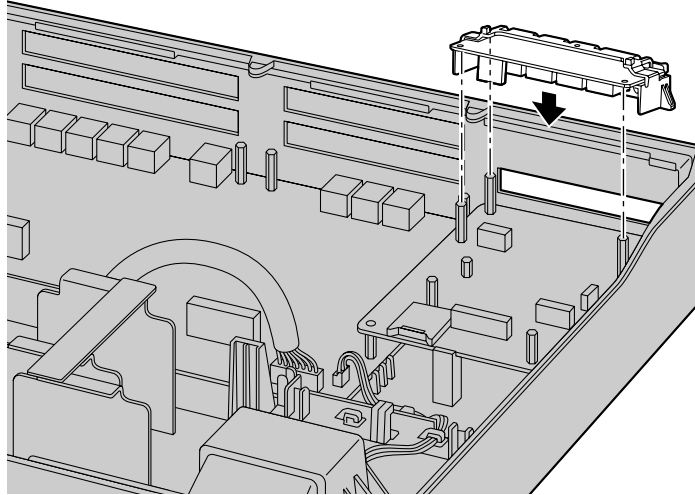

## 4.2.5 Installing/Removing the Optional Service Cards

---

3. Insert the screws into the holes on the card, and tighten the screws to secure the card.

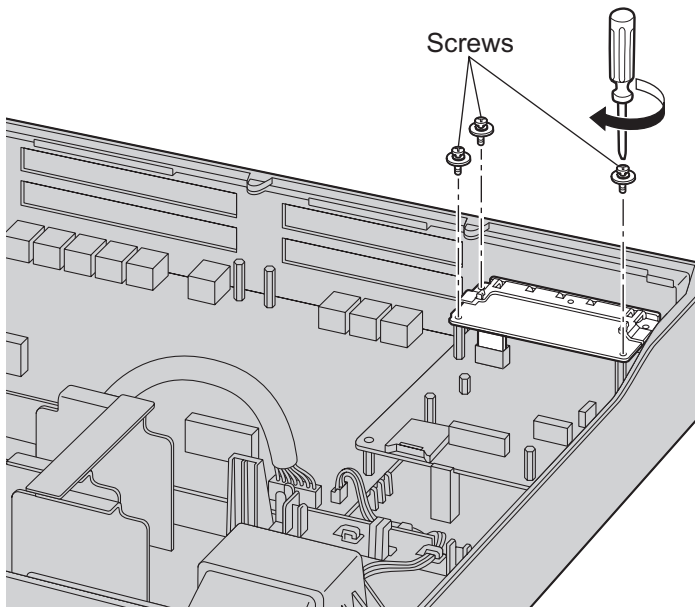

4. Connect cables to the appropriate ports of the card. For details about pin assignments, refer to the appropriate section in "4.6.1 EXP-M Card (KX-NS5130)".

### **Note**

Make sure to connect the cables after installing the card in the PBX, not before.

## Removing the EXP-M Card from the EXP-M Card slot

1. Loosen and remove the screws.

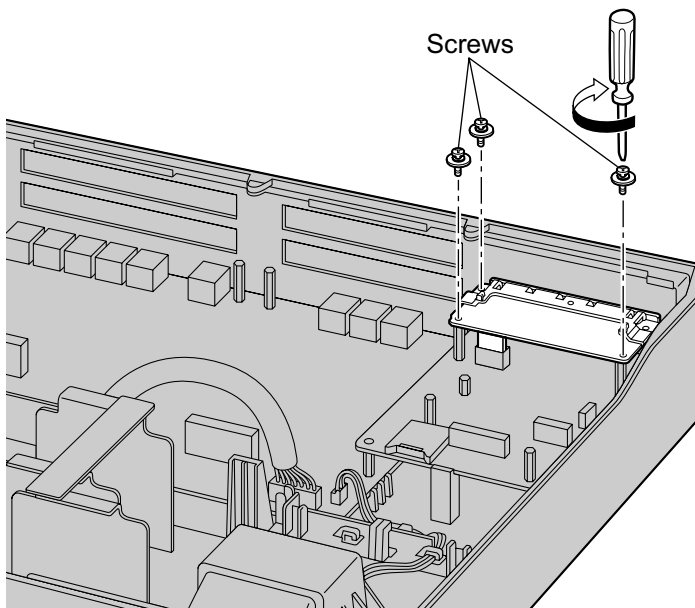

2. Holding the rear end of the card, pull the card in the direction of the arrows.

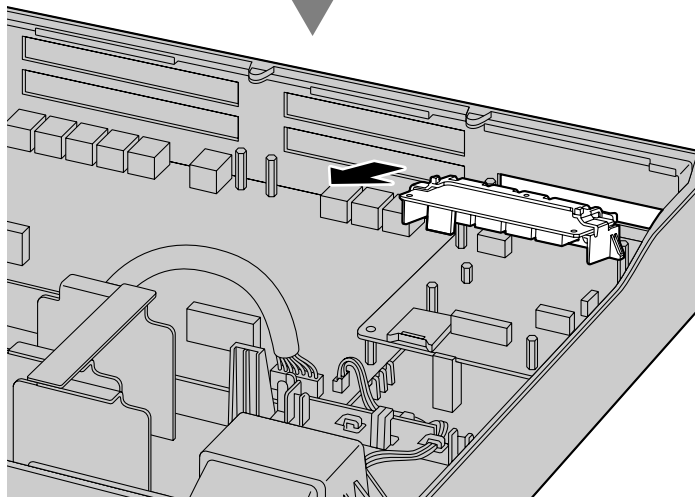
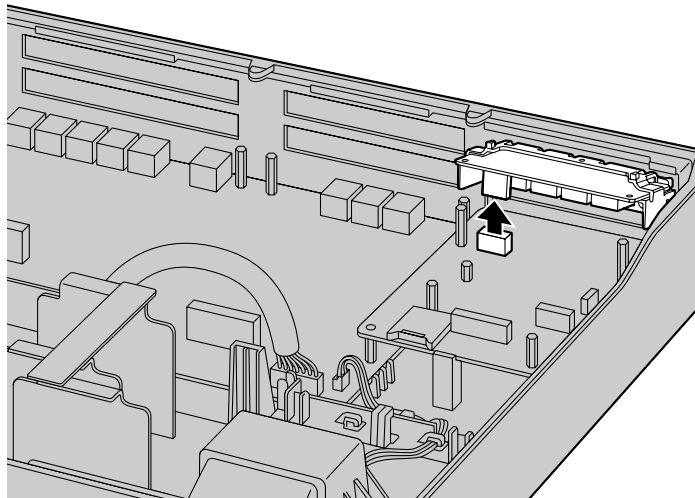

### Slot covers

Only remove the dummy cover plates when you are planning to install an optional service card. If you do not install an optional service card, insert a slot cover included with the option service card, as shown in the following procedure.

#### To insert a slot cover

1. With the clip-side of the slot cover on the left, insert the right edge of the cover in the slot.

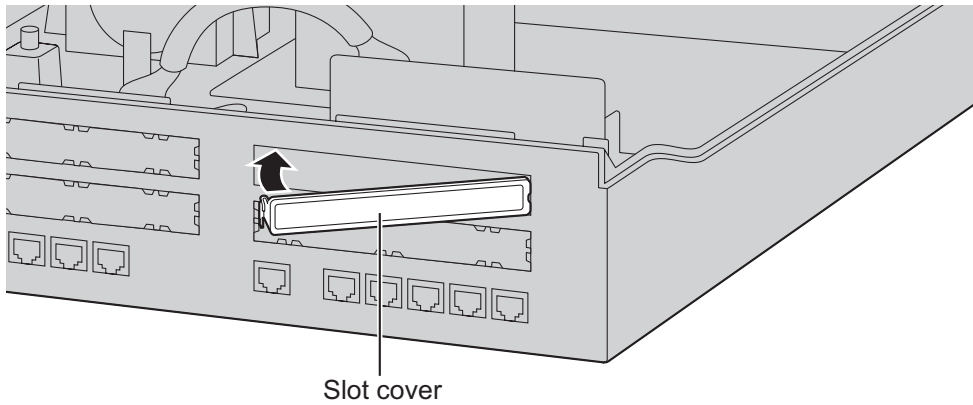

2. Push the left edge in until it clicks securely into place.

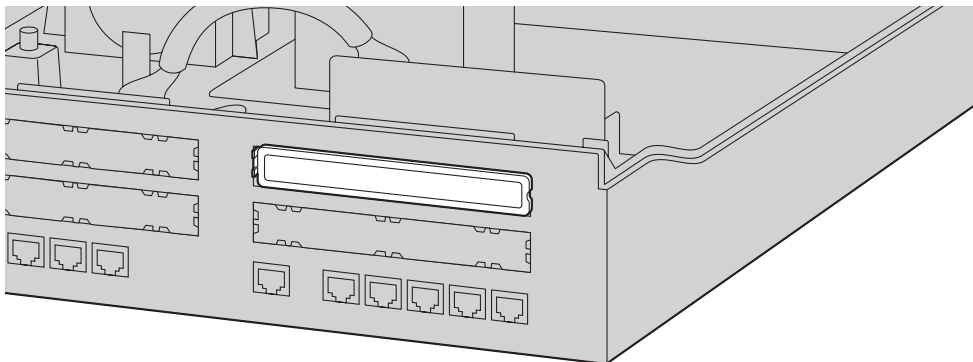



**To remove a slot cover**

1. Remove the top cover.  
Refer to "Opening the Top Cover" in "4.2.3 Opening/Closing the Top Cover".
2. From the inside, push the tab of the slot cover to the right and push out the left edge of the slot cover.

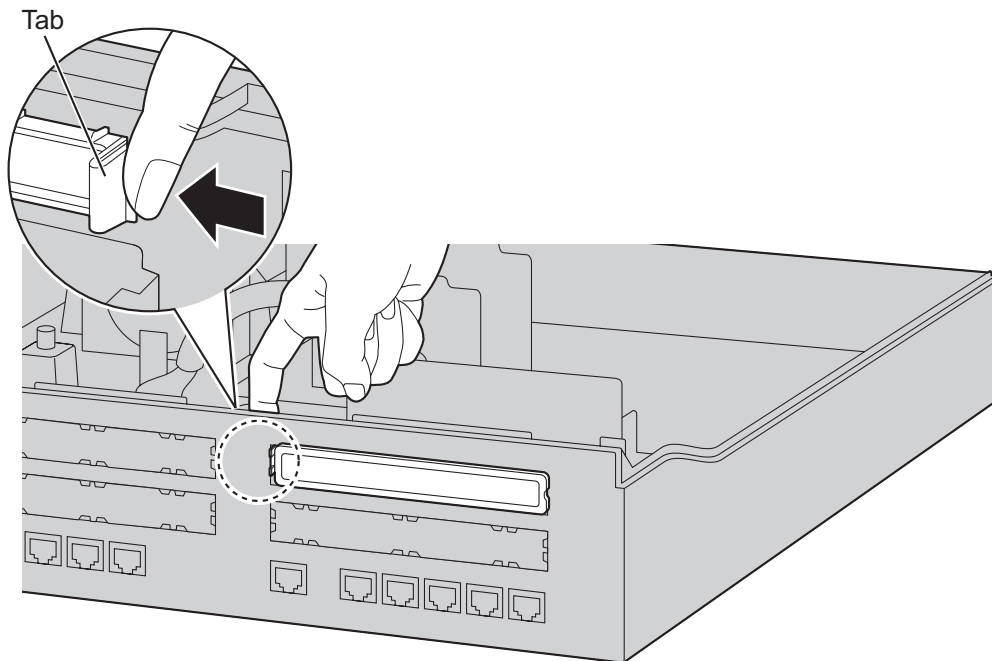

### 4.2.6 Installing/Removing the SD Memory Card

#### **CAUTION**

- Before touching the product (PBX, cards, etc.), discharge static electricity by touching ground or wearing an earthing strap. Failure to do so may cause the PBX to malfunction due to static electricity.
- When installing or removing the SD Memory Card, the power switch must be turned off.
- When installing or removing the SD Memory Card, do not put pressure on any parts of the mother board. Doing so may result in damage to the PBX.
- The SD Memory Card contains software and the customer data. Therefore, do not allow unauthorised access to prevent data leakage.
- To prevent data leakage, render the SD Memory Card physically unusable before disposal.

#### **Notice**

- Use only a Panasonic optional SD Memory Card.
- The SD Memory Card must be inserted in the SD Memory Card slot of the mother board before startup.

#### **Note**

- The maximum length of file names for files that are to be stored in the SD Memory Card is 60 characters.

### Installing the SD Memory Card

1. Insert the SD Memory Card into the slot on the mother board.

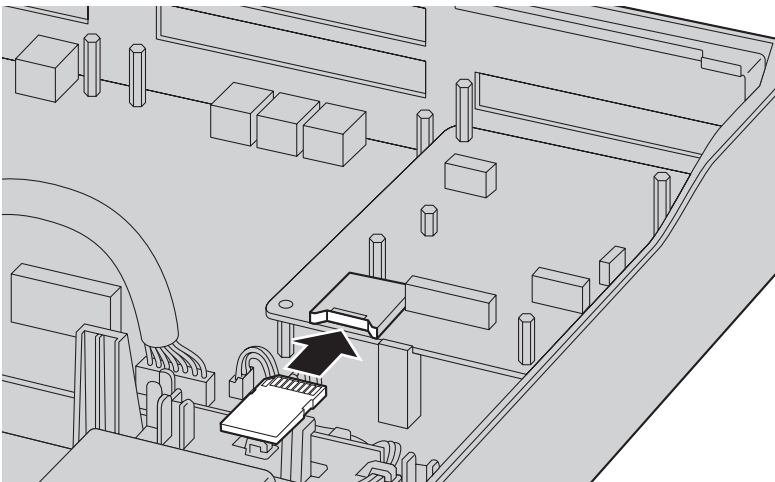

#### **Before Removing the SD Memory Card**

When you want to back up Unified Messaging system data, a separate backup procedure is required. For details about backing up Unified Messaging data, refer to "6.8 Tool—UM Data Backup" in the PC Programming Manual.

#### **Upgrading from the Installed SD Memory Card**

To increase Voice Mail recording time, you can install a larger sized optional SD Memory Card. For details about optional SD Memory Cards, refer to "4.3.2 SD Memory XS Card (KX-NS3134), SD Memory S Card (KX-NS3135), SD Memory M Card (KX-NS3136)".

#### **System Prompts**

Optional SD Memory Cards contain system prompts for Unified Messaging. However, system prompts language data stored in the SD Memory Card differ from those found in the optional SD Memory Cards.

For information about the system prompt languages in each SD Memory Card, refer to "9.2 System Prompt Languages".

The system prompt language data you are using on the installed SD Memory Card must be backed up if you want to continue using that SD Memory Card's system prompt language data. After backing up the system prompt language data, install the optional SD Memory Card, and then restore the backed up system prompt language data to the new SD Memory Card.

This procedure is described below.

1. Insert a USB memory device into the USB port of the PBX.  
(For details, refer to "Using a USB memory device" in "4.10 Connection of Peripherals".)
2. Back up the desired system prompts to the USB memory device.  
(For details, refer to "6.8 Tool—UM Data Backup" in the PC Programming Manual.)
3. Shut down the PBX, and then turn the power switch off.  
(For details about shutting down the PBX, refer to "5.4 System Control—System Shutdown" in the PC Programming Manual.)
4. Remove the SD Memory Card, and then install an optional SD Memory Card.  
(For details, refer to "4.3.2 SD Memory XS Card (KX-NS3134), SD Memory S Card (KX-NS3135), SD Memory M Card (KX-NS3136)".)
5. Start the PBX as described in "System Initialisation Procedure" in "4.13 Starting the KX-NS300".
6. Perform Easy Setup Wizard.  
(For details, refer to "5.4.1 Easy Setup Wizard".)
7. Restore the system prompts backed up in step 2. For details, refer to "6.9 Tool—UM Data Restore" in the PC Programming Manual.

### Removing the SD Memory Card

1. Remove the SD Memory Card installed in the slot on the mother board.

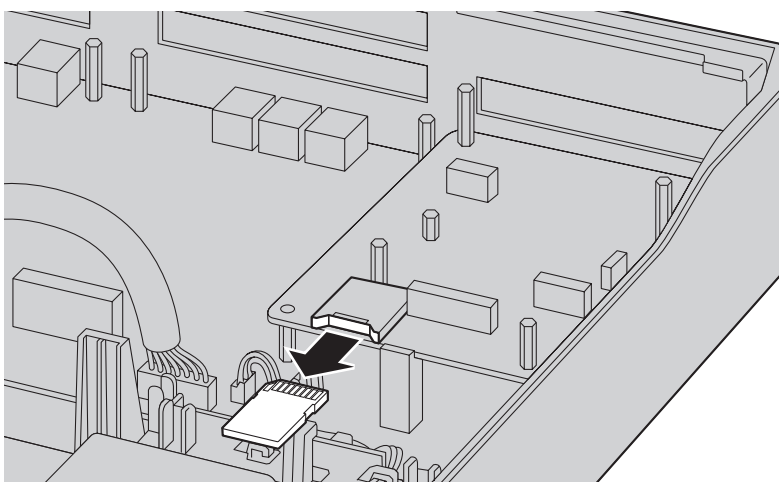
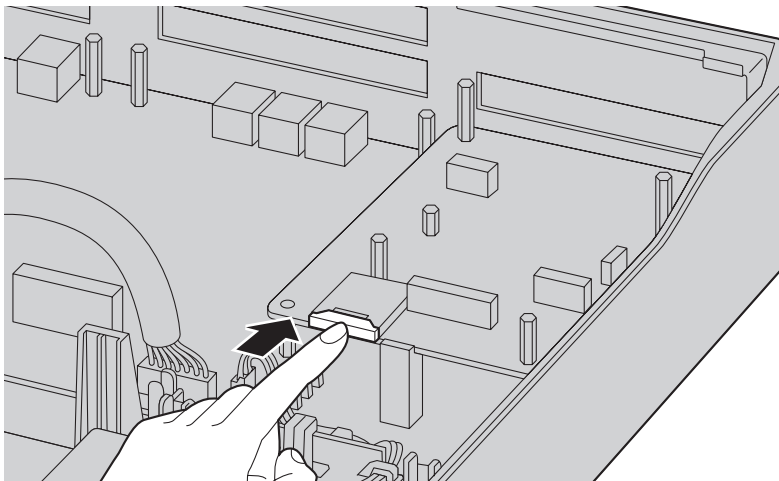

## 4.2.7 Types of Connectors

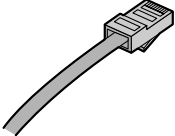
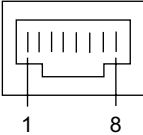
Connector Type	Pin Number	Used for
<p>RJ45</p>  <p>(Twisted pair cable)</p>		<ul style="list-style-type: none"> <li>• Mother board (KX-NS300) <ul style="list-style-type: none"> <li>– LAN Port</li> <li>– Trunk I/F Port</li> <li>– DPT I/F Port</li> <li>– SLT I/F Port</li> </ul> </li> <li>• Mother Board (KX-NS320) <ul style="list-style-type: none"> <li>– PFT I/F Port</li> <li>– SLT I/F Port</li> </ul> </li> <li>• EXP-M port</li> <li>• EXP-S port</li> <li>• LCOT6 (KX-NS5180)</li> <li>• PRI30/E1 (KX-NS5290CE)</li> <li>• DPH2 (KX-NS5162)</li> <li>• DHLC4 (KX-NS5170)</li> <li>• DLC8 (KX-NS5171)</li> <li>• DLC16 (KX-NS5172)</li> <li>• MCSLC8 (KX-NS5173)</li> <li>• MCSLC16 (KX-NS5174)</li> </ul>

### Note

- Pin assignments for RJ45 connectors differ depending on the card. Refer to the "Pin Assignments" section of each card in "Section 4 Installation".

## KX-TDA0158 connecting to KX-NS300

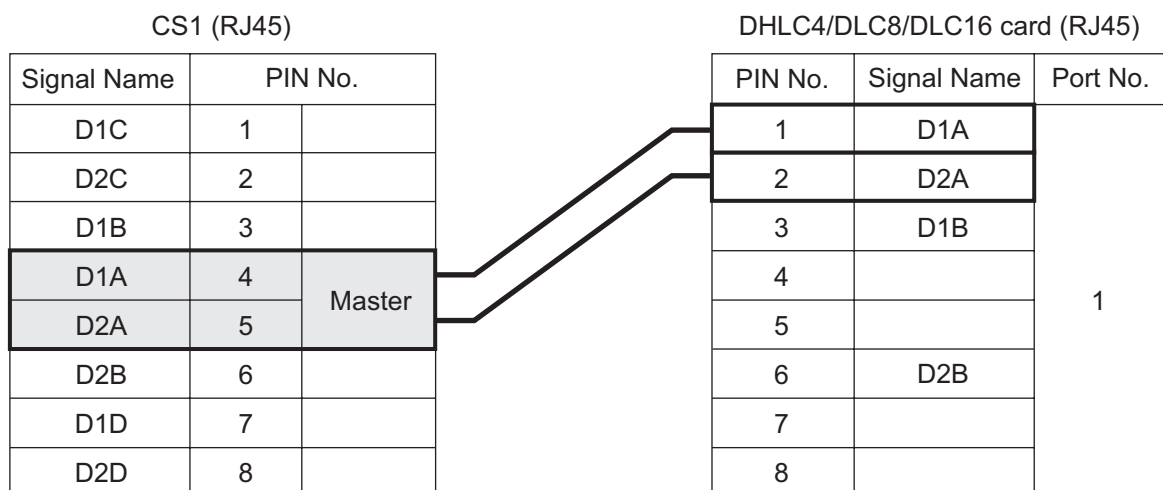

### Note

- The no. 4 and 5 pins (Master) of the CS must be connected to a pair of pins on the DHLC/DLC card.
- When connecting multiple KX-TDA0158 CSs to a DHLC/DLC card, make sure that the no. 4 and 5 pins (Master) of adjacent CSs are at least 1 pair of pins away on the card.
- CS connections must be made within the same DHLC/DLC card.

#### 4.2.7 Types of Connectors

---

- When a wrong connection is made, satisfactory performance of the CS cannot be guaranteed. Check the connection of CS and the PBX using the Web Maintenance Console. For information about how to view CS information using the Web Maintenance Console, refer to "4.1.2 Status—Equipment Status—CS Information" in the PC Programming Manual.
- KX-TDA0158 CS cannot be connected to DLC2 (installed by default).

## 4.2.8 Attaching a Ferrite Core

A ferrite core must be attached when an RJ45 connector is connected to the EXP-M card or EXP-S card.

### For the EXP-M/EXP-S Cards

Wrap the cable once around the ferrite core, then close the case of the ferrite core. Attach the ferrite core 5 cm away from the connector. The ferrite core is included with the Expansion Unit.

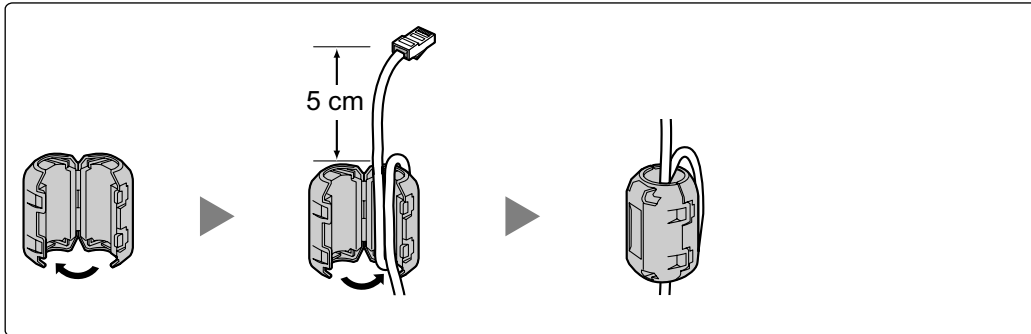

## 4.2.9 19-inch Rack Mounting

### WARNING

- Be careful not to drop any components. Dropping components may damage them or cause an injury.
- When mounting the PBX on a 19-inch rack, only use the 19-inch rack mounting equipment (attachment bracket, screws) included with the PBX.

### CAUTION

- When the PBX is mounted on a 19-inch rack, make sure that the installation of the unit does not cause the temperature of the rack to exceed its limit.
  - When the PBX is mounted on a 19-inch rack, do not block the openings of the PBX. Allow space of at least 10 cm around the PBX's fan.
  - If the PBX is not installed properly using the securing correct methods, the PBX may fall causing serious damage.
  - When this product is no longer in use, make sure to detach it from the rack.
1. Fix the attachment brackets to the left and right sides of the PBX with 3 screws on each side. (Recommended torque: 0.8 N·m [8.2 kgf·cm] to 1.0 N·m [10.2 kgf·cm]) → ❶
  2. Place the PBX in the 19-inch rack and fix both attachment brackets to the rack with the rack's proprietary mounting equipment. → ❷

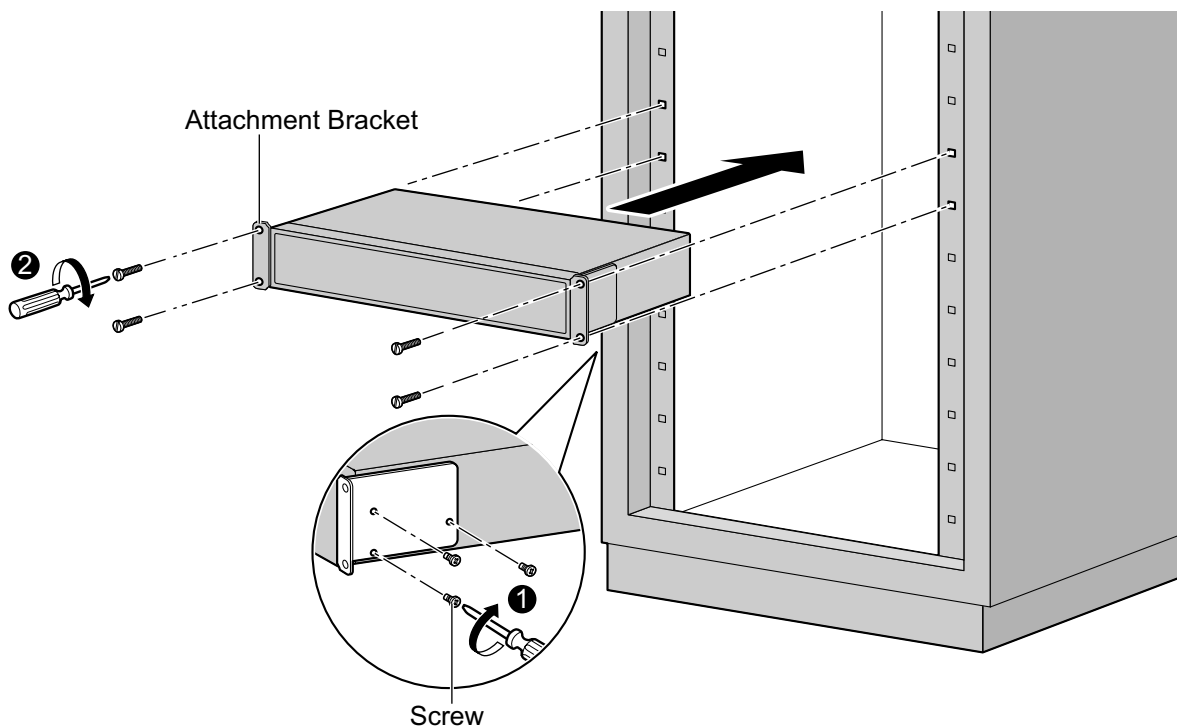



## 4.2.10 Wall Mounting

The PBX can be mounted on a concrete wall using the optional wall mounting kit.

### **WARNING**

- **Make sure that the wall that the unit will be attached to is strong enough to support approximately 4 times the weight of the unit. If not, it is necessary for the wall to be reinforced.**
- **Only use the wall-mounting equipment (screws and washers) included with the PBX.**
- **Be careful not to drop any components. Dropping components may damage them or cause an injury.**
- **Proper earthing (connection to earth) is very important to reduce the risk to the user of electrocution or to protect the PBX from the bad effects of external noise in the case of a lightning strike. (See "4.2.4 Frame Earth Connection".)**



### **CAUTION**

- Make sure to install all necessary optional service cards in the PBX before performing the wall mounting procedure. If it is necessary to install or remove a card, make sure to detach the PBX from the wall before installing or removing the card.
- Do not block the openings of the PBX. Allow space of at least 20 cm above and 10 cm at the sides of the PBX.
- Make sure that the surface behind the PBX is flat and free of obstacles, so that the openings on the back of the PBX will not be blocked.
- If the PBX is not installed properly using the securing correct methods, the PBX may fall causing serious damage.
- When driving the screws into the wall, be careful to avoid touching any metal laths, wire laths or plates in the wall.
- When this product is no longer in use, make sure to detach it from the wall.

### **Note**

For details about dimensions and weight of the PBX, see "2.3.1 General Description".

### **Necessary Items**

<b>Included in the PBX</b>		
Screw A (For use in concrete)		3
Washer		3

### **Wall Mounting Procedures**

### **CAUTION**

Drive mounting screws into the wall. Be careful to avoid touching any metals laths, wire laths or metal plates in the wall.

## 4.2.10 Wall Mounting

### Mounting on a Wooden Wall

The included screws may be used when mounting the main unit on a wooden wall.

1. Measure the actual space as indicated below to mark the 3 screw positions on the wall.

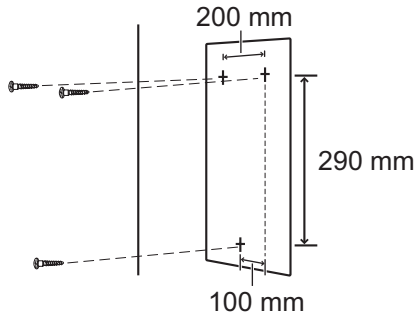

2. Install the screws and washers (included) to the wall.

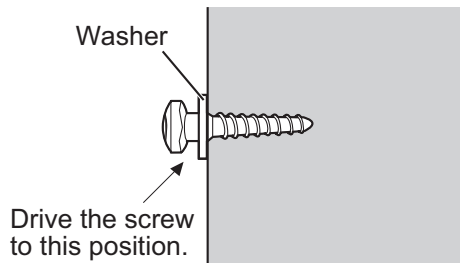

#### Note

- As indicated above, do not tighten the screw fully.
- The pull-out strength of the installation area must be at least 294 N (30 kgf) per screw.
- Do not block the operations of the cabinet. Allow space of at least 20 cm above and 10 cm at the sides of the cabinet.
- Make sure that screw heads are the same distance from the wall.
- Install the screw perpendicular to the wall.

3. Hook the main unit on the screw heads.

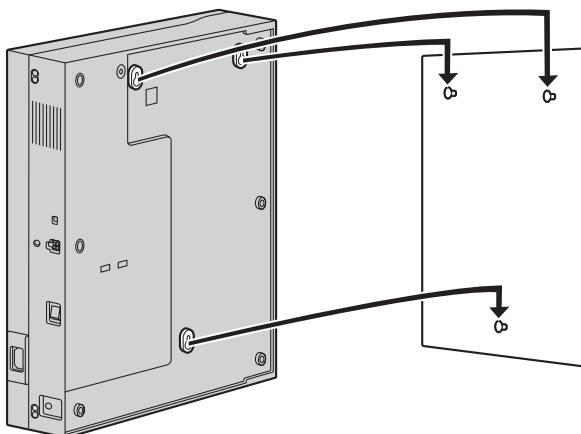

## Mounting on a Concrete

The included screws may be used when mounting the main unit on a concrete wall. User-supplied anchor plugs are also necessary.

1. Measure the actual space as indicated below to mark the 3 screw positions on the wall.

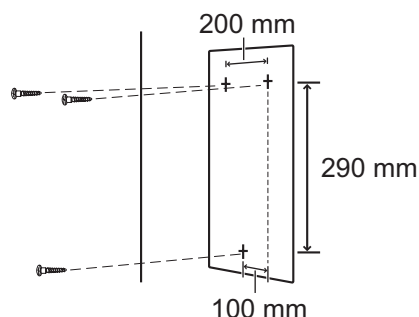

2. Drill holes in the wall as marked and fit the anchor plugs (not included) into the holes.

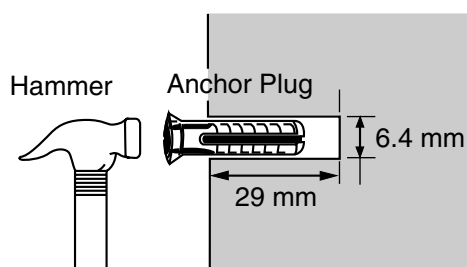

3. Fit the washers on the screws, and drive the screws into the anchor plugs.

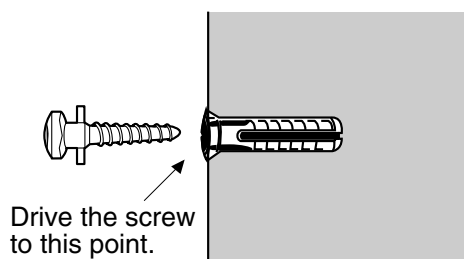

### Note

- As indicated above, do not tighten the screw fully.
- The pull-out strength of the installation area must be at least 294 N (30 kgf) per screw.
- Do not block the operations of the cabinet. Allow space of at least 20 cm above and 10 cm at the sides of the cabinet.
- Make sure that screw heads are the same distance from the wall.
- Install the screw perpendicular to the wall.

#### 4.2.10 Wall Mounting

---

4. Hook the main unit on the screw heads.

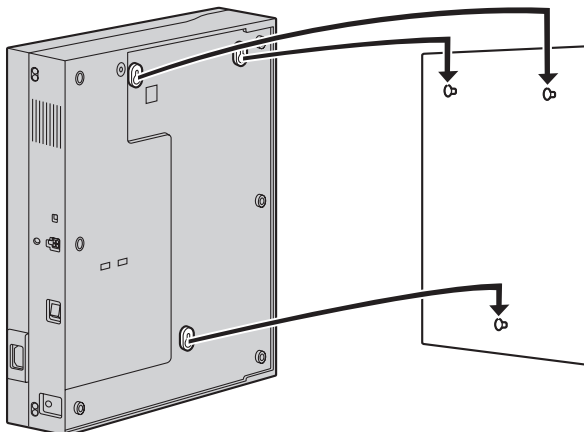

## 4.2.11 Surge Protector Installation

### CAUTION

Performing surge protection is essential. Make sure to follow the instructions in this section.

### Overview

A massive electrical surge can be caused if lightning strikes a telephone cable 10 m above ground, or if a telephone line comes into contact with a power line. A surge protector is a device that is connected to a trunk to prevent potentially dangerous electrical surges from entering the building via the trunk and damaging the PBX and connected equipment.

To protect the system from electrical surges, we strongly recommend connecting the system to a surge protector that meets the following specifications:

- Surge arrester type: 3-electrode arrester
- DC spark-over voltage: 230 V
- Maximum peak current: at least 10 kA

Additionally, proper earthing is very important for the protection of the system (refer to "4.2.4 Frame Earth Connection").

Many countries/areas have regulations requiring surge protection. Be sure to comply with all applicable laws, regulations, and guidelines.

### Installation

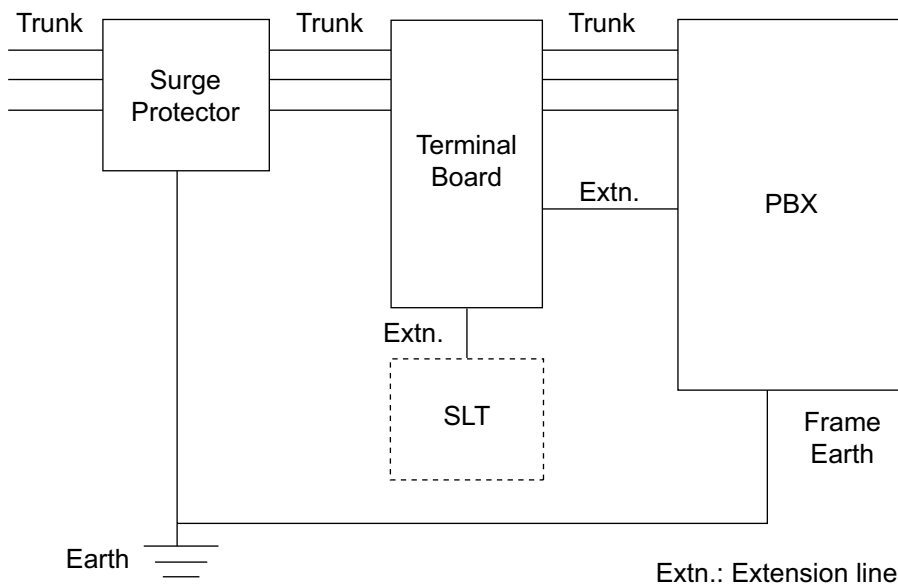

## Outside Installation

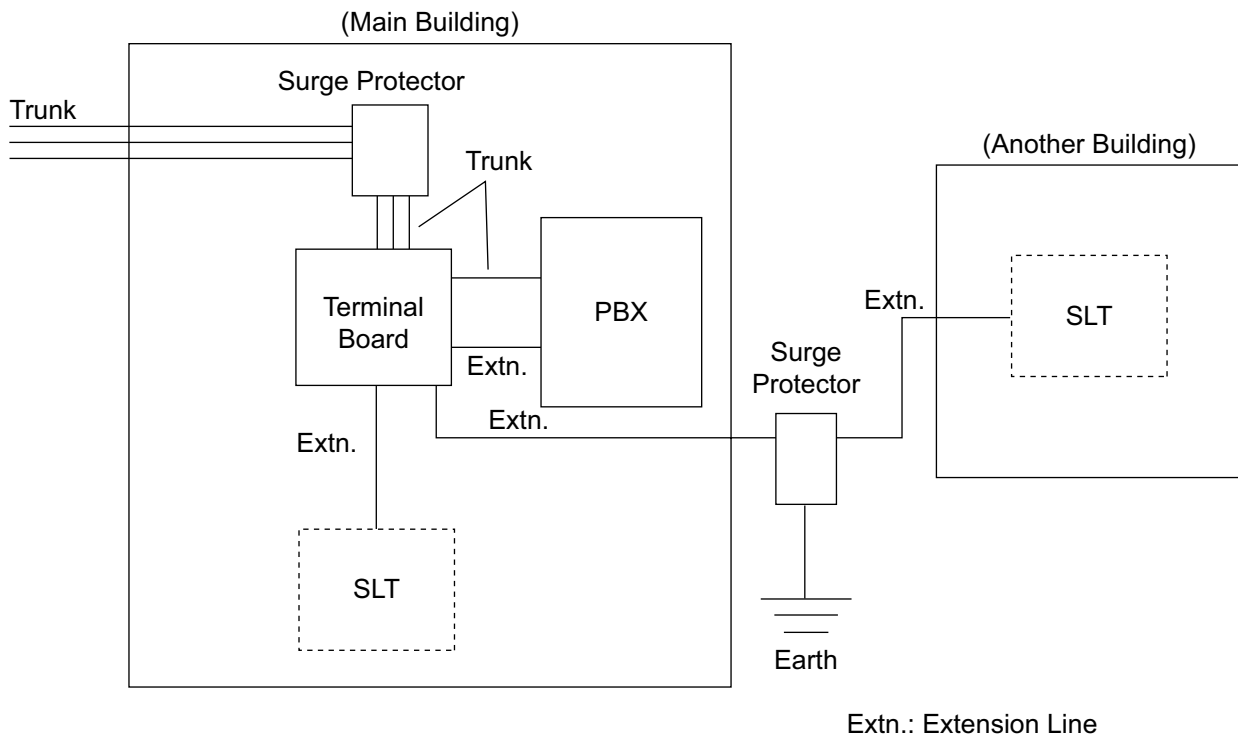

If you install an extension outside of the building, the following precautions are recommended:

- a. Install the extension wire underground.
- b. Use a conduit to protect the wire.

### Note

The surge protector for an extension is different from that for trunks.

## Installation of an Earth Rod

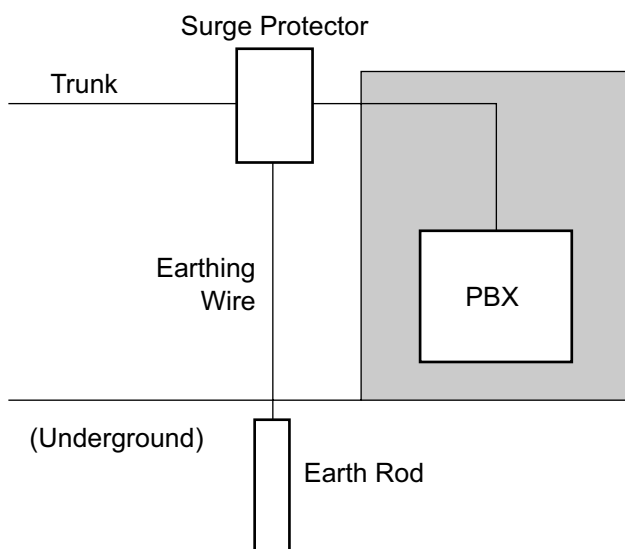

1. Connect the earth rod to the surge protector using an earthing wire with a cross-sectional area of at least 1.3 mm<sup>2</sup>.
2. Bury the earth rod near the protector. The earthing wire should be as short as possible.
3. The earthing wire should run straight to the earth rod. Do not run the wire around other objects.
4. Bury the earth rod at least 50 cm underground.

**Note**

- The above figures are recommendations only.
- The length of earth rod and the required depth depend on the composition of the soil.

## 4.2.12 Backup Battery Connection

The backup batteries and Back-up Battery Cable provide a backup power supply to allow full use of the PBX in the event of a power failure. In case of power failure, the backup batteries automatically maintain the power to the PBX without interruption.

### User-supplied Items

- Backup Batteries: VRLA (Valve Regulated Lead Acid) 12 V DC × 3
- Back-up Battery Cable: KX-A228

### WARNING

- **There is a danger of explosion if backup batteries are incorrectly replaced. Replace only with the same or equivalent type recommended by the battery manufacturer. Dispose of used batteries according to the manufacturer's instructions.**
- **Make sure that you do not short the backup batteries or cables.**

### CAUTION

- Make sure that the Back-up Battery Cable is securely fastened to both the backup batteries and the PBX.
- Make sure that the polarities of the backup batteries and wiring are correct.
- Use the correct type of Back-up Battery Cable for the PSU.

### Notice

Be sure to comply with applicable local regulations (e.g., laws, guidelines).

### Note

- Turn on the battery switch on the PSU only after the installation of the PBX is finished and AC power is available.
- The recommended maximum capacity is 28 Ah, to maintain effective battery charge.
- Make sure that the type and capacity of the 3 backup batteries are identical.
- The Back-up Battery Cable should not be exposed to direct sunlight. Keep the Back-up Battery Cable and the backup batteries away from heating appliances and fire. Place the backup batteries in a ventilated place.
- For details about the backup batteries, refer to the manual for the batteries.

## Backup Power Supply Duration

The length of time that backup batteries can power the PBX varies depending on the total load figure. For how to calculate the load figure from the connected items, refer to "Load Figure Calculation".

### Examples

Battery Capacity	Backup Power Supply Duration <sup>*1</sup>
28 Ah	16 h

<sup>\*1</sup> The duration may vary depending on the conditions.

## Connecting Backup Batteries

1. Turn off the battery switch on the back side.



2. Connect the Back-up Battery Cable to a set of 3 identical backup batteries.

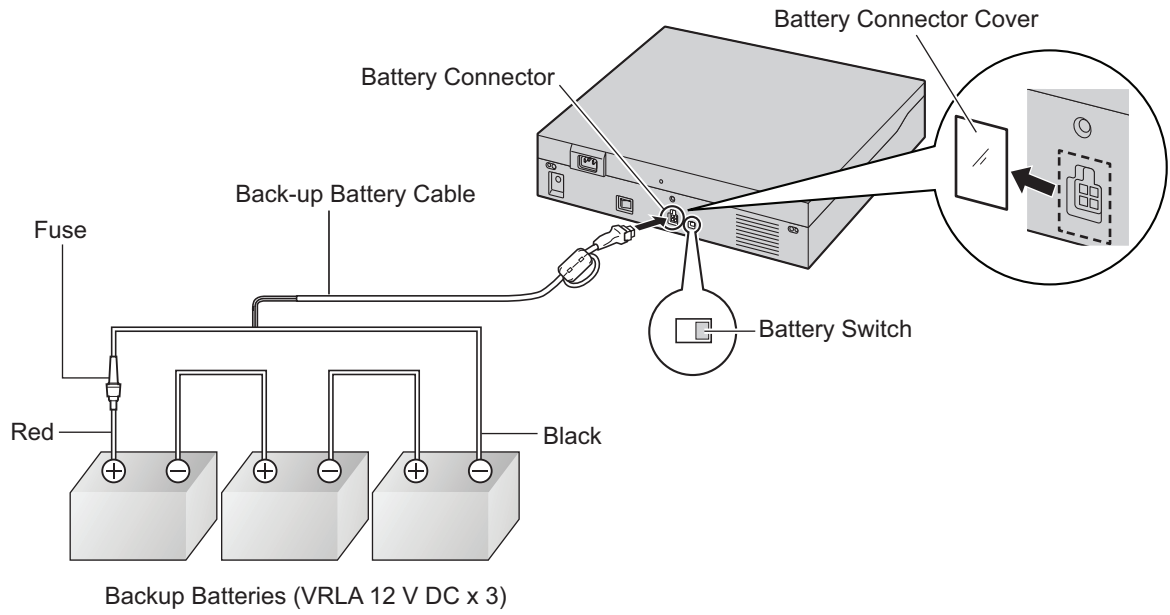

## 4.3 The Mother Board and Expansion Cards

### 4.3.1 Mother Board

#### 4.3.1.1 Mother Board - KX-NS300

##### Function

The mother board is the preinstalled processing board with activation keys for CA Basic-Express for unlimited users, use of 4 IP-PT, and 2 Unified Messaging ports. The Virtual Cards (trunk/extension) can be installed in Virtual Slots of the mother board and can be activated with the activation keys. Also, the mother board supports LAN connection so that IP telephones (IP-PTs, IP softphones, SIP phones) and PCs can be connected on a private IP network.

##### Mountable Cards

- DSP S Card (refer to "4.3.3 DSP S Card (KX-NS5110)")
- SD Memory Card (refer to "4.3.2 SD Memory XS Card (KX-NS3134), SD Memory S Card (KX-NS3135), SD Memory M Card (KX-NS3136)")
- Remote Card refer to "4.3.10 RMT card in KX-NS300 (KX-TDA0196)"

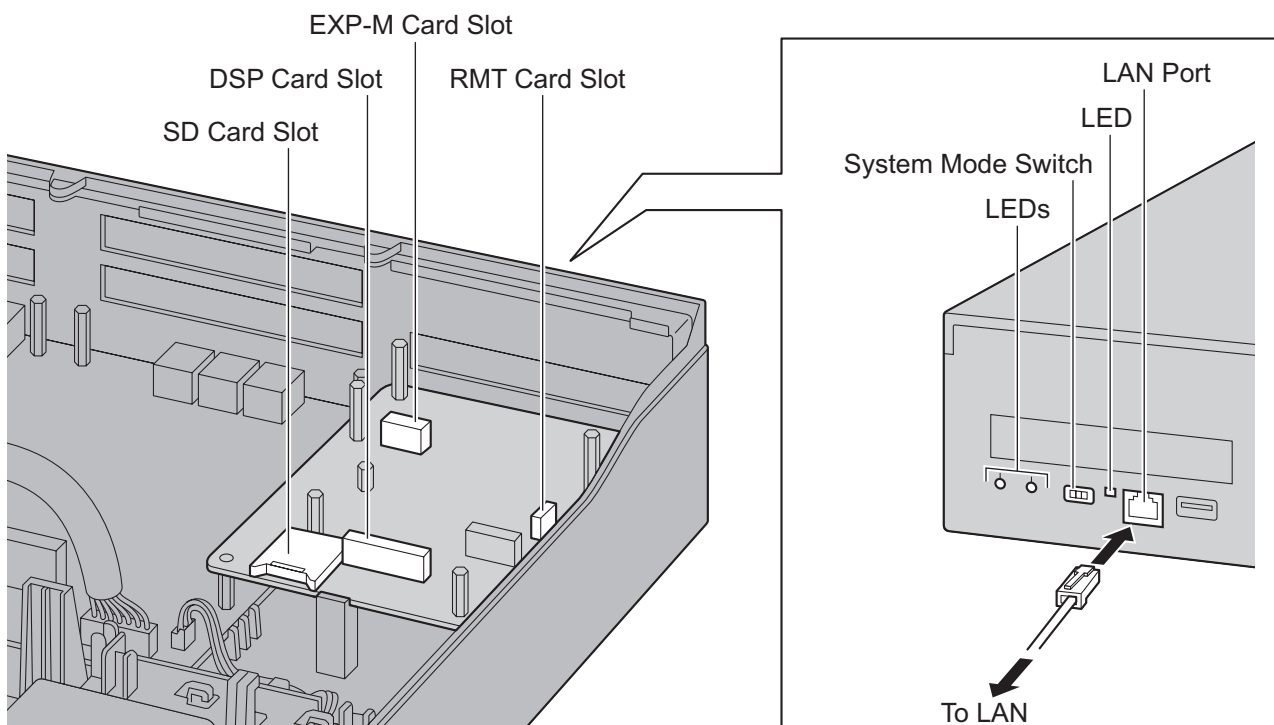

##### Note

- Make sure to use the LAN port for LAN connection.
- The maximum length of the CAT 5/CAT 5e cables to be connected to the mother board is 100 m.
- For installing and removing the SD Memory Card, refer to "4.2.6 Installing/Removing the SD Memory Card".
- For details about Virtual Slots, refer to "2.3.3 System Capacity".

- If the preinstalled activation keys on the mother board are not enough for the desired configuration, you need to purchase activation key codes. For details about the activation keys, refer to "3.1 Information about the Activation Keys".
- For details about connecting to a LAN, refer to "4.11 LAN Connection".
- For details about connecting peripherals, refer to "4.10 Connection of Peripherals".
- For details about System Mode Switch, refer to "4.13 Starting the KX-NS300".

### **WARNING**

A lithium battery is used in the mother board. There is a risk of explosion if the battery is replaced with the incorrect type. Dispose of used batteries according to the manufacturer's instructions.

## Pin Assignments

### LAN Port (10BASE-T/100BASE-TX)

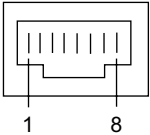
	No.	Signal Name	Input (I)/Output (O)	Function
	1	TPO+	O	Transmit data+
	2	TPO-	O	Transmit data-
	3	TPI+	I	Receive data+
	4-5	Reserved	–	–
	6	TPI-	I	Receive data-
	7-8	Reserved	–	–

## LED Indications

Indication	Colour	Description
STATUS	Green	PBX status indication <ul style="list-style-type: none"> <li>• OFF: Power Off</li> <li>• ON: Power On and running</li> <li>• Flashing (60 times per minute): Starting up/ Logging in</li> <li>• Flashing (120 times per minute): PFMPR is updating</li> </ul>
	Amber	PBX status indication <ul style="list-style-type: none"> <li>• ON: Ready to shutdown</li> <li>• Flashing (60 times per minute): Shutting down</li> </ul>
	Red	PBX status indication <ul style="list-style-type: none"> <li>• ON: Alarm</li> <li>The cause may be one of the following:               <ul style="list-style-type: none"> <li>– Power was cut without performing the shutdown procedure.</li> <li>– No IP address(es) assigned for the DSP card(s) by the DHCP server.</li> <li>– Alarm for an optional service card.</li> </ul> </li> <li>• Flashing (240 times per minute): Initialise failed</li> </ul>
PBX MODE	Off	<ul style="list-style-type: none"> <li>• Not Used</li> </ul>

### 4.3.1 Mother Board

Indication			Colour	Description
10BASE-T/ 100BASE-TX	LAN	LINK	Green	Link status indication <ul style="list-style-type: none"> <li>• OFF: Off-line</li> <li>• ON: Linked normally</li> <li>• Flashing: In communication</li> </ul>

### 4.3.1.2 Mother Board - KX-NS320

#### Function

The mother board of expansion unit KX-NS320 is the pre-installed processing board with the EXP-S card, PFT card, MCSLC16 card.

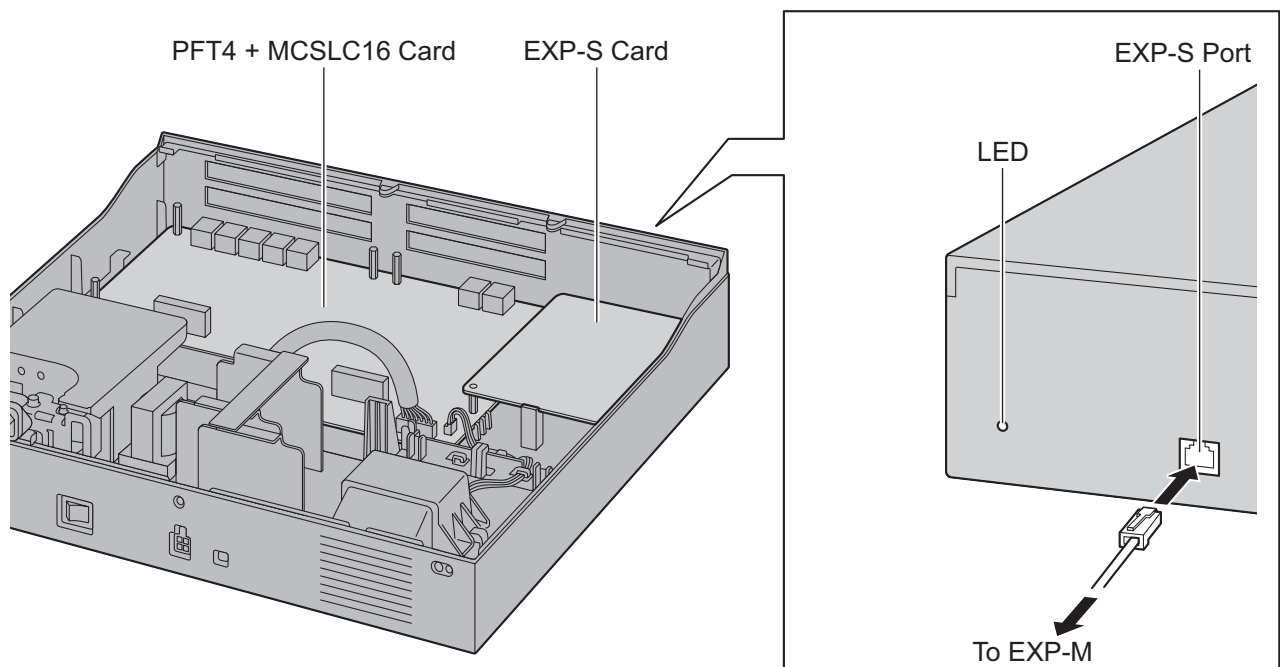

#### LED Indication

Indication	Colour	Description
STATUS	Off	Power Off
	Green On	On Line
	Green flashing (60 times per minute)	Starting Up
	Green flashing (120 times per minute)	EXP-S card Programme error
	Red On	On Line with Alarm
	Red flashing (60 times per minute)	OUS (Out of service)

## 4.3.2 SD Memory XS Card (KX-NS3134), SD Memory S Card (KX-NS3135), SD Memory M Card (KX-NS3136)

### Function

<b>SD Memory XS, S, M Card:</b>	If you install one of the SD Memory card, you can expand the number of SMDR data and Hotel Billing data.
<b>SMDR data:</b>	1000 (default), 40000 (with SD memory card)
<b>Hotel Billing data:</b>	1000 (Default), 10000 (with SD memory card)
<b>Store ACD report data:</b>	300,000
<b>SD Memory XS:</b>	SD Memory with maximum of 40 hours Voice Mail recording time.
<b>SD Memory S:</b>	SD Memory with maximum of 200 hours Voice Mail recording time.
<b>SD Memory M:</b>	SD Memory with maximum of 400 hours Voice Mail recording time.

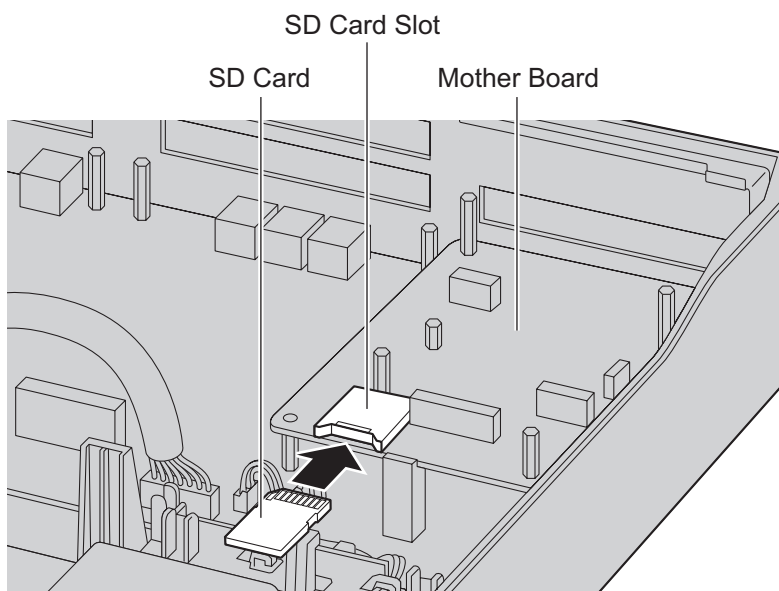

### Accessories and User-supplied Items

**Accessories (included):** none

**User-supplied (not included):** none

### Note

For installing and removing the SD Memory Card, refer to "4.2.6 Installing/Removing the SD Memory Card".

If you install one of the SD memory card, SVM features cease to function. Instead, UM features become functional.

## 4.3.3 DSP S Card (KX-NS5110)

### Function

A DSP card is a digital signal processor card with DSP resources that can be used for VoIP calls, conferences, the Unified Messaging feature, and the DISA/OGM feature. The DSP card is compliant with ITU-T G.729A and G.711 codec methods.

To operate the IP trunk and/or IP extension, DSP S card must be installed.

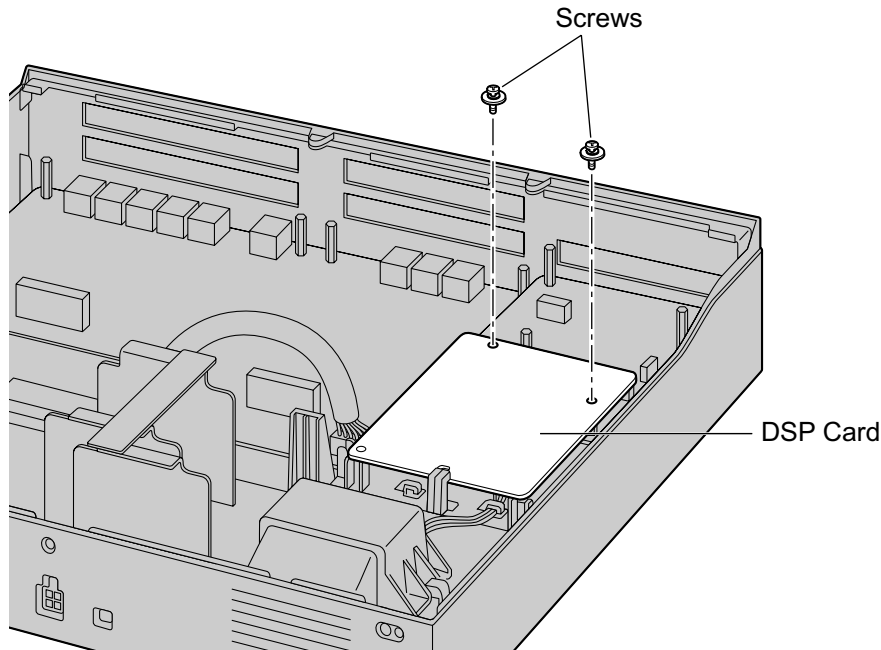

### Accessories and User-supplied Items

**Accessories (included):** Screws × 2

**User-supplied (not included):** none

### CAUTION

When installing or removing the optional service cards, do not put pressure on any parts of the mother board. Doing so may result in damage to the PBX.

### Note

The DSP Resource Advisor can be used to calculate DSP resource usage easily. For details, refer to "9.37.1.1 PBX Configuration—[1-5-1] Configuration—DSP Resource—Setting—DSP Resource Advisor" in the PC Programming Manual.

## DSP Resource Information

The number of resources provided by each type of DSP card is as follows:

DSP Card Type	Number of Resources
DSP S	63

## IP Address Information

1 IP address must be assigned to each DSP card, depending on the type of DSP card. You can assign an IP address to the DSP card during Easy Setup Wizard or through system programming.

For details about Easy Setup Wizard, refer to "5.4.1 Easy Setup Wizard".

For details about assigning IP addresses through System Programming, refer to "Changing IP Address Settings".

DSP Card Type	Number of IP Addresses
DSP S	1

## 4.3.4 LCOT6 in KX-NS300 (installed by default)

### Function

- 6 analogue trunk ports with Caller ID (FSK/FSK with Call Waiting Caller ID [Visual Caller ID]/DTMF).
- 6 MOH/External Pager port.
- 2 ports are power failure transfer (PFT) ports. (Port 1 and Port 2)

### Note

- CO ports number, MOH ports number and External Pager ports number are as table below.
- You can select port Type "CO use (default)", "MOH or External Pager use" for each port by using WEB Maintenance Console.
- Pair of an ODD port number and an EVEN port should be CO use or MOH/Pager use.  
Example. If you select Port 5 as MOH (BGM 7), Port 6 should be MOH (Port 8) or Pager 6 as below.

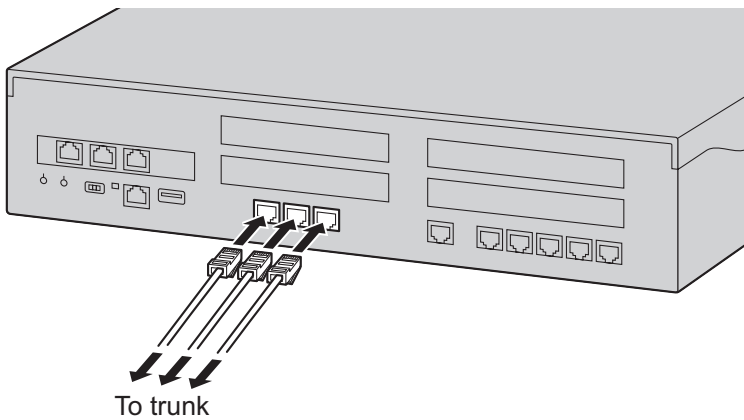

### Port Type and Port Number

Port Type	Port Number
CO (Default)	Port 1 = CO 1
	Port 2 = CO 2
	Port 3 = CO 3
	Port 4 = CO 4
	Port 5 = CO 5
	Port 6 = CO 6
MOH	Port 1 = BGM 3
	Port 2 = BGM 4
	Port 3 = BGM 5
	Port 4 = BGM 6
	Port 5 = BGM 7
	Port 6 = BGM 8



External Pager	Port 1 = Pager 1
	Port 2 = Pager 2
	Port 3 = Pager 3
	Port 4 = Pager 4
	Port 5 = Pager 5
	Port 6 = Pager 6

**Port Type Setting by Web Maintenance Console**

No.	Shelf	Slot	Port	Port Type
	ALL			ALL
1	2	1	1	CO
2	2	1	2	CO
3	2	1	3	CO
4	2	1	4	CO
5	2	1	5	MOH(BGM7)
6	2	1	6	Pager6

CO Use (points to rows 1-4)  
 CO Use (points to row 3)  
 MOH or External Pager Use (points to row 5)

**Note**

- For details about power failure transfer, refer to "4.12 Power Failure Connections".
- To confirm the trunk connection, refer to "Confirming the Trunk Connection" in "4.13 Starting the KX-NS300".

**Pin Assignment**

**For Trunk Use**

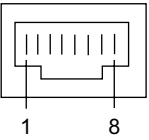
	No.	Signal Name	Function
	1	TA	Tip port 1
	2	RA	Ring port 1
	3	Reserved	–
	4	Reserved	–
	5	Reserved	–
	6	Reserved	–
	7	TB	Tip port 2
	8	RB	Ring port 2

#### 4.3.4 LCOT6 in KX-NS300 (installed by default)

---

##### For MOH/Pager Use

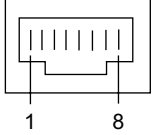
	No.	Signal Name	Function
	1	M/P1 A	Music/Pager port 1
	2	M/P2 A	Music/Pager port 1
	3	Reserved	–
	4	Reserved	–
	5	Reserved	–
	6	Reserved	–
	7	M/P1 B	Music/Pager port 2
	8	M/P2 B	Music/Pager port 2

## 4.3.5 DLC2 in KX-NS300 (installed by default)

### Function

- 2 digital extension port for DPT and PT-interface CSs.

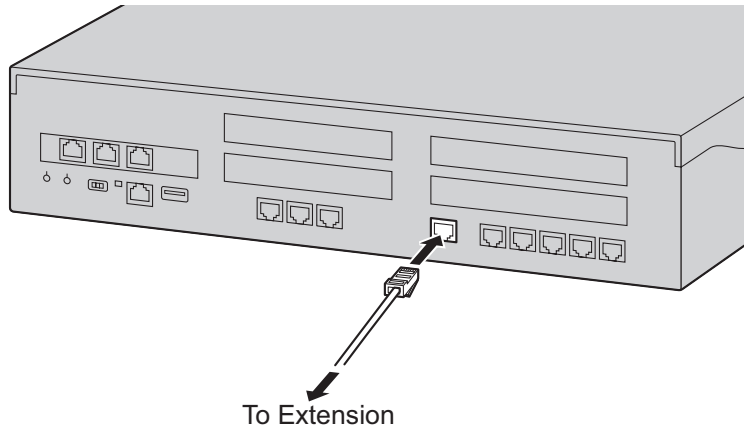

### Pin Assignments

For DLC port

	No.	Signal Name	Function
	1	D1 A	Data port 1 (Low)
	2	D2 A	Data port 1 (High)
	3	D1 B	Data port 2 (Low)
	4	Reserved	–
	5	Reserved	–
	6	D2 B	Data port 2 (High)
	7	Reserved	–
	8	Reserved	–

## 4.3.6 MCSLC16 in KX-NS300 (installed by default)

### Function

- 16 extension ports for SLT with Caller ID (FSK), Message Waiting Lamp control, and 2 power failure transfer (PFT) ports. Maximum power output of 90 V for Message Waiting Lamp control.

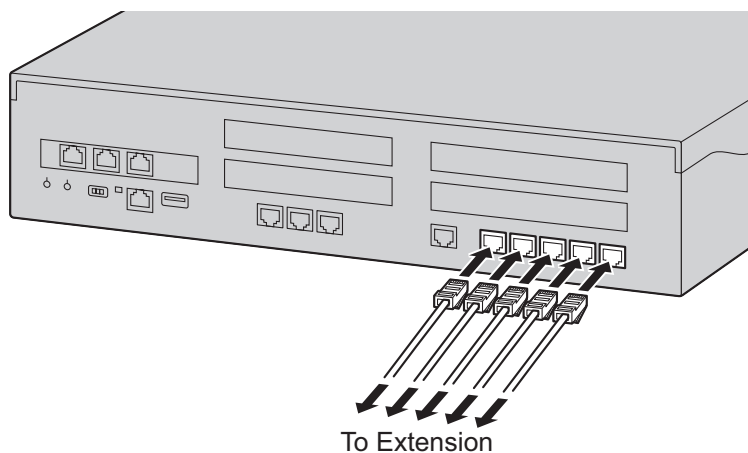

### Note

- For details about power failure transfer, refer to "4.12 Power Failure Connections".

### Pin Assignments

For MCSLC16 port 1-2 and port 3-4

	No.	Signal Name	Function
	1	TA	Tip port 1
	2	RA	Ring port 1
	3	Reserved	–
	4	Reserved	–
	5	Reserved	–
	6	Reserved	–
	7	TB	Tip port 2
	8	RB	Ring port 2

## For MCSLC16 port 5-8, port 9-12 and port 13-16

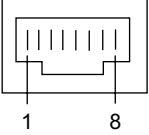
	No.	Signal Name	Function
	1	TA	Tip port 1
	2	RA	Ring port 1
	3	TB	Tip port 2
	4	TC	Tip port 3
	5	RC	Ring port 3
	6	RB	Ring port 2
	7	TD	Tip port 4
	8	RD	Ring port 4

## 4.3.7 EXP-S in KX-NS320 (installed by default)

### Function

- EXP-S is pre-installed in the SPR card (KX-NS320) to be used as Expansion Unit.
- By using this card, you can expand the Usage of Legacy Trunks and extensions.

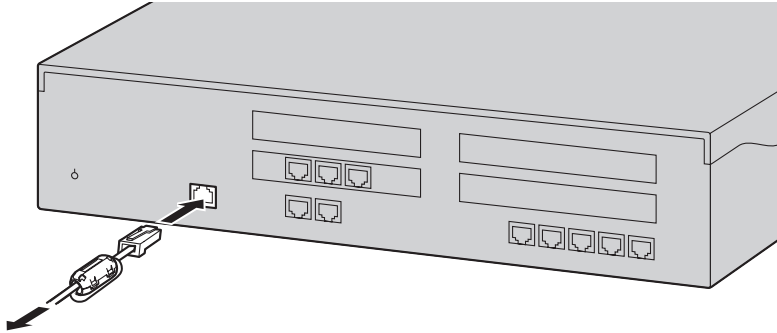

To EXP-M Card

### Notice

- When connecting the RJ45 connector, attach the ferrite core (included with the KX-NS320). Refer to "4.2.8 Attaching a Ferrite Core".

### Pin Assignments

For EXP-S port

	No.	Signal Name	Function
	1	UHW+	Receive data+
	2	UHW-	Receive data-
	3	REFCLK+	Reference CLK+
	4	FHCLK+	Frame and System CLK+
	5	FHCLK-	Frame and System CLK-
	6	REFCLK-	Reference CLK-
	7	DHW+	Transmit data+
	8	DHW-	Transmit data-

## 4.3.8 PFT in KX-NS320 (installed by default)

### Function

When the power supply to the Expansion Unit fails, power failure transfer (PFT) will switch from the current connection to the Power Failure Connection. Refer to "5.6.2 Power Failure Transfer" in the Feature Guide for further information.

The detail information about this card, refer to "4.12 Power Failure Connections".

### Pin Assignments

For PFT port

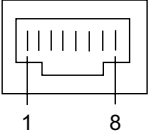
	No.	Signal Name	Function
	1	TA	Tip port 1
	2	RA	Ring port 1
	3	Reserved	–
	4	Reserved	–
	5	Reserved	–
	6	Reserved	–
	7	TB	Tip port 2
	8	RB	Ring port 2

4.3.8 PFT in KX-NS320 (installed by default)

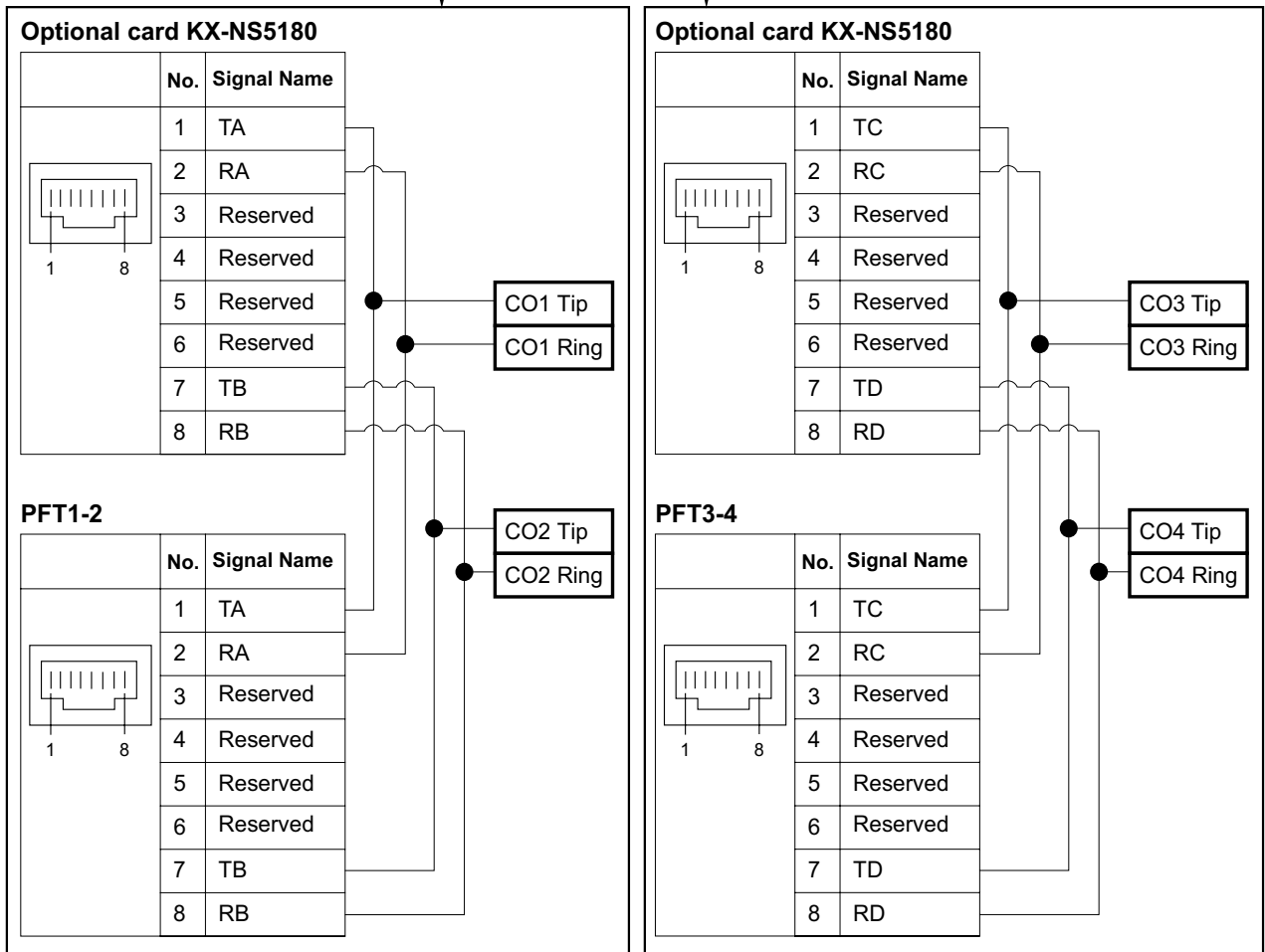
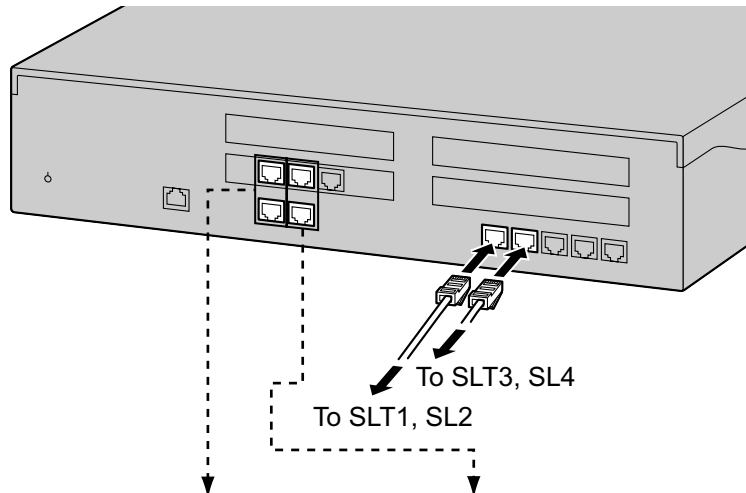



## 4.3.9 MCSLC16 in KX-NS320 (installed by default)

### Function

- 16 extension ports for SLT with Caller ID (FSK), Message Waiting Lamp control, and 4 power failure transfer (PFT) ports. Maximum power output of 90 V for Message Waiting Lamp control.

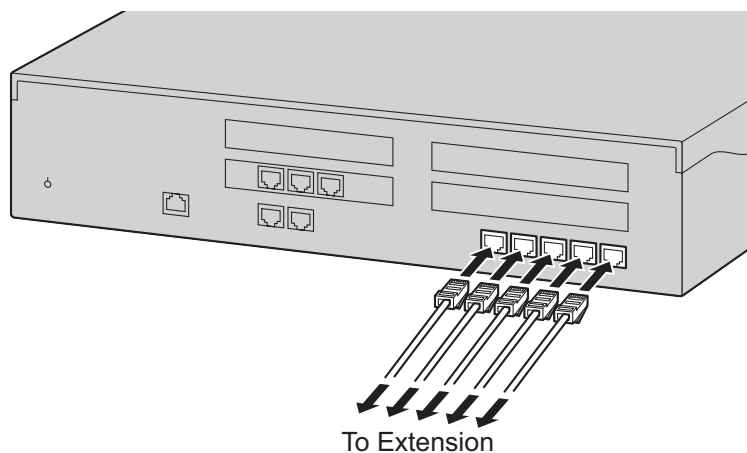

### Note

- For details about power failure transfer, refer to "4.12 Power Failure Connections".

### Pin Assignments

For MCSLC port 1-2 and Port 3-4

	No.	Signal Name	Function
	1	TA	Tip port 1
	2	RA	Ring port 1
	3	Reserved	—
	4	Reserved	—
	5	Reserved	—
	6	Reserved	—
	7	TB	Tip port 2
	8	RB	Ring port 2

#### 4.3.9 MCSLC16 in KX-NS320 (installed by default)

---

##### For MCSLC port 5-8, port 9-12 and port 13-16

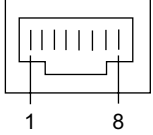
	No.	Signal Name	Function
	1	TA	Tip port 1
	2	RA	Ring port 1
	3	TB	Tip port 2
	4	TC	Tip port 3
	5	RC	Ring port 3
	6	RB	Ring port 2
	7	TD	Tip port 4
	8	RD	Ring port 4

## 4.3.10 RMT card in KX-NS300 (KX-TDA0196)

### Function

Analogue modem card for remote communication with the PBX. IUT-T V.90 support. To be mounted on the KX-NS300 MPR card.

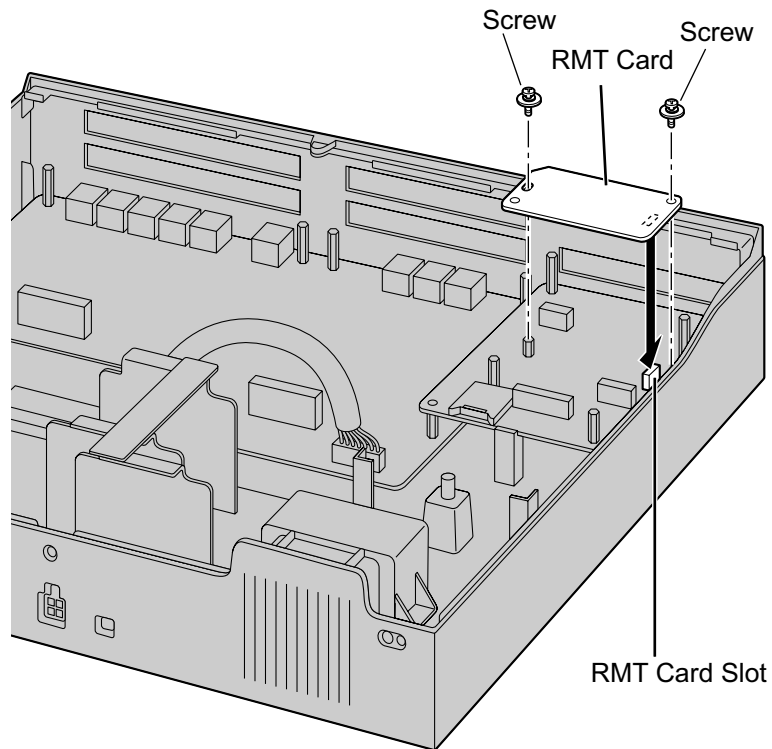

### Accessories and User-supplied Items

**Accessories (included):** Screw x 2

## 4.4 Virtual Cards

### Function

Virtual Cards are programs included with the mother board and that are treated as virtual cards by Web Maintenance Console for convenience. Those programs can be activated with the appropriate activation key (apart from V-IPCS4 cards, which do not require activation keys). By installing Virtual Cards in the Virtual Slots of the mother board using Web Maintenance Console, IP trunks, IP extensions, and IP-CSs can be used via the mother board.

Virtual Card	Description
Virtual 4-Channel SIP Trunk Card (V-SIPGW4)	Virtual Card for 4-channel SIP trunk. Compliant with RFC 3261, 3262, 3264, 3311, 3581, 3960 and 4028 protocols, and ITU-T G.729A and G.711 codec methods. Also supports T.38 protocol.
Virtual 4-Channel VoIP Gateway Card (V-IPGW4)	Virtual Card for 4-channel H.323 trunk. Compliant with VoIP H.323 V.5 protocol, and ITU-T G.729A and G.711 codec methods. Also supports T.38 protocol.
Virtual 8-Channel VoIP Extension Card (V-IPEXT8)	Virtual Card for 8 IP-PTs (KX-NT300 series, KX-NT500 series, and KX-NT265 [software version 2.00 or later only]). Compliant with Panasonic proprietary protocol, and ITU-T G.729A, G.711 and G.722 codec methods.
Virtual 8-Channel SIP Extension Card (V-SIPEXT8)	Virtual Card for 8 third party SIP phones. Compliant with RFC 3261, 3264, 3310, 2327 and 4028 protocols, and ITU-T G.729A, G.711 and G.722 codec methods. Also supports T.38 Protocol.
Virtual 4 IP Cell Station Interface Card (V-IPCS4)	Virtual Card for 4 IP-CSs. Compliant with ITU-T G.729A and G.711 codec methods.
Virtual UT Extension Card (V-UTEXT8)	Virtual Card for 8 KX-UT series SIP phones. Compliant with RFC 2327, 3261, 3264, 3310, 3515, 4028 and 4235 protocols, and ITU-T G.729A, G.711 and G.722 codec methods. Also supports WSD, CWMP and HTTP.

**Example: Virtual Cards in the Virtual Slots of the PBX**

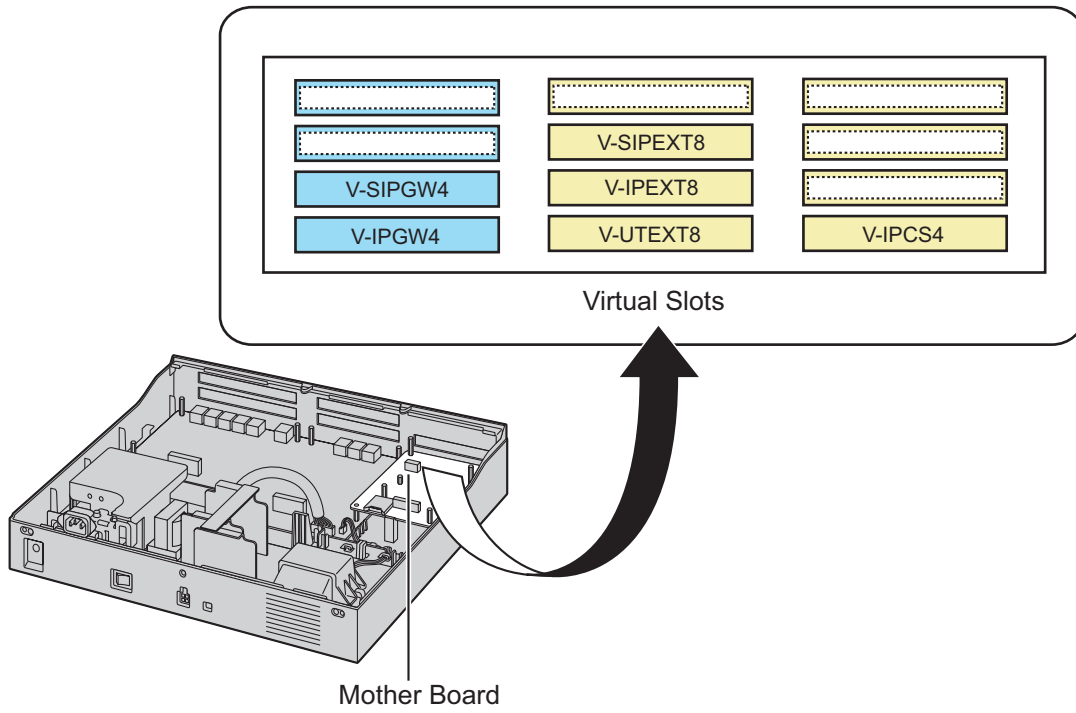

## 4.5 Physical Trunk and Extension Cards

### 4.5.1 LCOT6 Card (KX-NS5180)

#### Function

A combination card including:

- 6 analogue trunk ports with Caller ID (FSK/FSK with Call Waiting Caller ID [Visual Caller ID]/DTMF).

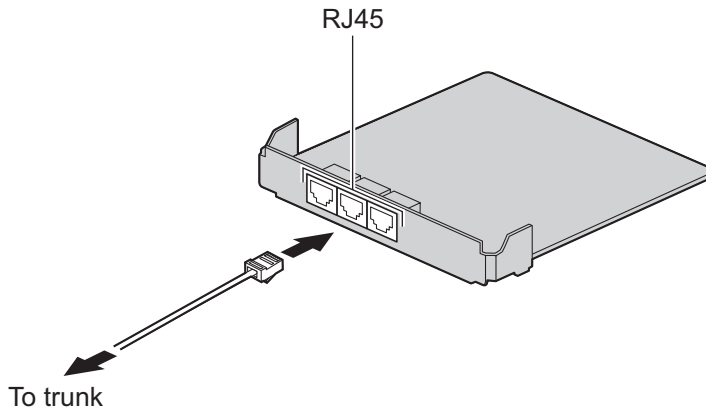

#### Accessories and User-supplied Items

**Accessories (included):** Spacer × 3, slot cover × 1

**User-supplied (not included):** RJ45 connector, Copper wire

#### Note

- For details about power failure transfer, refer to "4.12 Power Failure Connections".
- To confirm the trunk connection, refer to "Confirming the Trunk Connection" in "4.13 Starting the KX-NS300".

### Pin Assignments

#### For Trunk Use

	No.	Signal Name	Function
	1	TA	Tip port 1
	2	RA	Ring port 1
	3	Reserved	—
	4	Reserved	—
	5	Reserved	—
	6	Reserved	—
	7	TB	Tip port 2
	8	RB	Ring port 2

## 4.5.2 PRI30/E1 Card (KX-NS5290CE)

### Function

A combination card including:

- 1 ISDN Primary Rate Interface port (30B channels).  
EURO-ISDN/ETSI compliant.
- 1 E1 port (30B channels).  
ITU-T standard compliant.

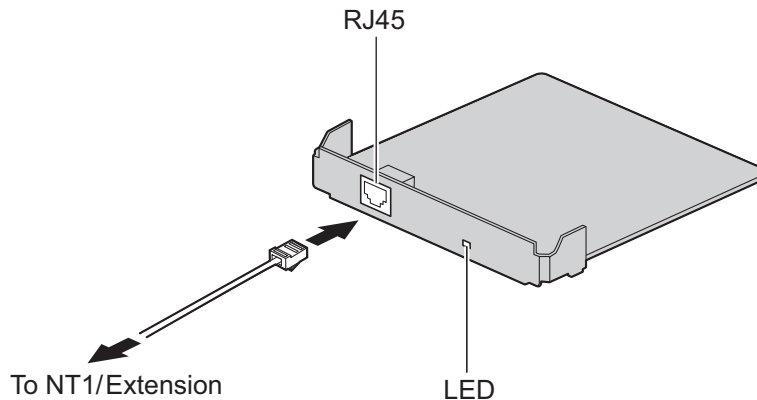

### Accessories and User-supplied Items

**Accessories (included):** Spacer × 3, slot cover × 1

**User-supplied (not included):** RJ45 connector, Twisted pair cable

### CAUTION

- When connecting this optional service card to the trunk, connect through an NT1; do not connect to the U interface of the trunk directly.
- PRI ports are SELV ports and should only be connected to SELV services.

### Notice

- The cable to connect to the ISDN Primary Rate Interface port of the PRI30/E1 card should be CAT 5 (Category 5) or higher.

### Note

- You can select PRI30 use or E1 use by Web Maintenance Console.
  - For switching from PRI30 use to E1 use:  
Delete the PRI30 card first and select the E1 card in the "PBX Configuration → Configuration → Slot" screen of the Web Maintenance Console. To restart the PBX, click **Maintenance** → **System Control** → **System Reset**.
  - For switching from E1 use to PRI30 use:  
Delete the E1 card first and select the PRI30 card in the "PBX Configuration → Configuration → Slot" screen of the Web Maintenance Console. To restart the PBX, click **Maintenance** → **System Control** → **System Reset**.
- In some countries/areas, this optional service card must not be connected to the Public Switched Telephone Network.
- To confirm the trunk connection, refer to "Confirming the Trunk Connection" in "4.13 Starting the KX-NS300".

## Pin Assignments

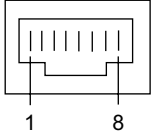
	No.	Signal Name	Level [V]	Function
	1	RX+	(+)	Receive data (+)
	2	RX-	(-)	Receive data (-)
	3	Reserved	-	-
	4	TX-	(-)	Transmit data (-)
	5	TX+	(+)	Transmit data (+)
	6-8	Reserved	-	-

### For Trunk Use

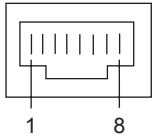
	No.	Signal Name	Level [V]	Function
	1	RX+	(+)	Receive data (+)
	2	RX-	(-)	Receive data (-)
	3	Reserved	-	-
	4	TX-	(-)	Transmit data (-)
	5	TX+	(+)	Transmit data (+)
	6-8	Reserved	-	-

**Example:  
Telephone Company  
PRI/E1 Line**

1	TX(+)
2	TX(-)
3	
4	RX(-)
5	RX(+)
6-8	

### For Extension/QSIG Use

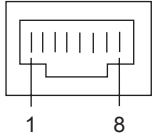
	No.	Signal Name	Level [V]	Function
	1	RX+	(+)	Receive data (+)
	2	RX-	(-)	Receive data (-)
	3	Reserved	-	-
	4	TX-	(-)	Transmit data (-)
	5	TX+	(+)	Transmit data (+)
	6-8	Reserved	-	-

**Example:  
Behind PBX**

1	RX(+)
2	RX(-)
3	
4	TX(-)
5	TX(+)
6-8	

## LED Indications

### When you select PRI use

Indication	Colour	Description
STATUS	Green	Off : All Ports OUS or Fault On: INS (In Service) Flashing (60 times per minute): Normal (a port is in use)



**When you select E1 use**

Indication	Colour	Description
STATUS	Green	Off : All Ports OUS or Fault On: At lease one port is In Service Flashing (60 times per minute): Normal (a port is in use)

**Maximum Cabling Distance of Extension Connection**

The maximum length of the extension cable that connects the PRI port is shown below:

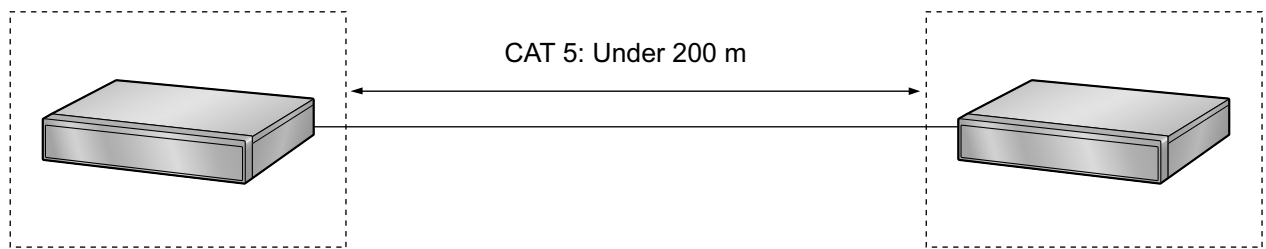

## 4.5.3 DHLC4 Card (KX-NS5170)

### Function

4-port digital hybrid extension card for DPTs, APTs, SLTs, DSS consoles, and PT-interface CSs.

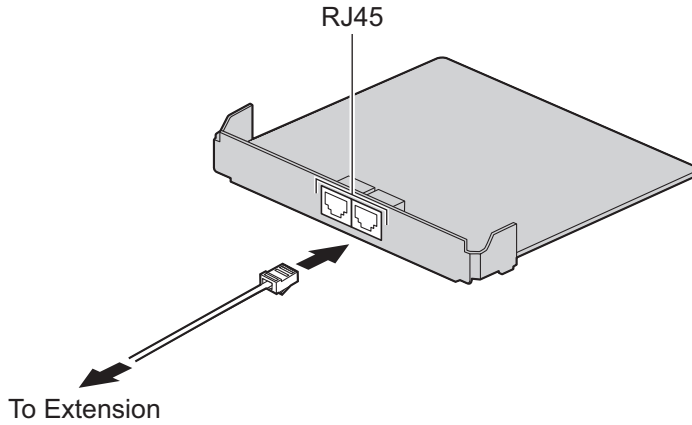

### Accessories and User-supplied Items

**Accessories (included):** Spacer × 3, slot cover × 1

**User-supplied (not included):** RJ45 connector, Twisted pair cable

### Pin Assignments

	No.	Signal Name	Function
	1	D1A	Data port 1 (low)
	2	D2A	Data port 1 (High)
	3	D1B	Data port 2 (low)
	4	TB	Tip port 2
	5	RB	Ring port 2
	6	D2B	Data port 2 (High)
	7	TA	Tip port 1
	8	RA	Ring port 1

## 4.5.4 DLC8 Card (KX-NS5171)

### Function

8-port digital extension card for DPTs and PT-interface CSs.

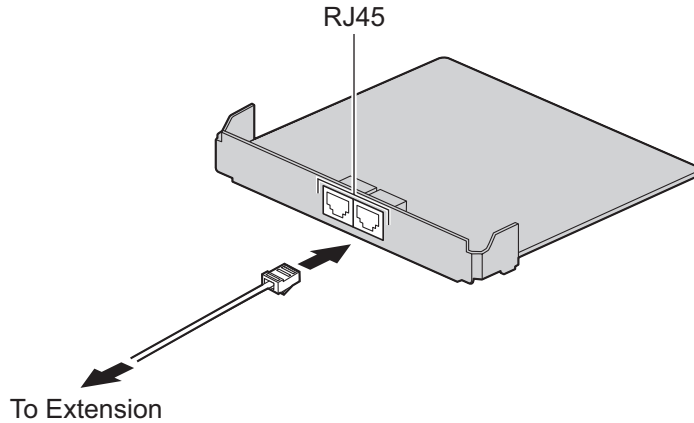

### Accessories and User-supplied Items

**Accessories (included):** Spacer × 4, slot cover × 1

**User-supplied (not included):** RJ45 connector, Twisted pair cable

### Pin Assignments

	No.	Signal Name	Function
	1	D1A	Data port 1 (Low)
	2	D2A	Data port 1 (High)
	3	D1B	Data port 2 (Low)
	4	D1C	Data port 3 (Low)
	5	D2C	Data port 3 (High)
	6	D2B	Data port 2 (High)
	7	D1D	Data port 4 (Low)
	8	D2D	Data port 4 (High)

## 4.5.5 DLC16 Card (KX-NS5172)

### Function

16-port digital extension card for DPTs and PT-interface CSs.

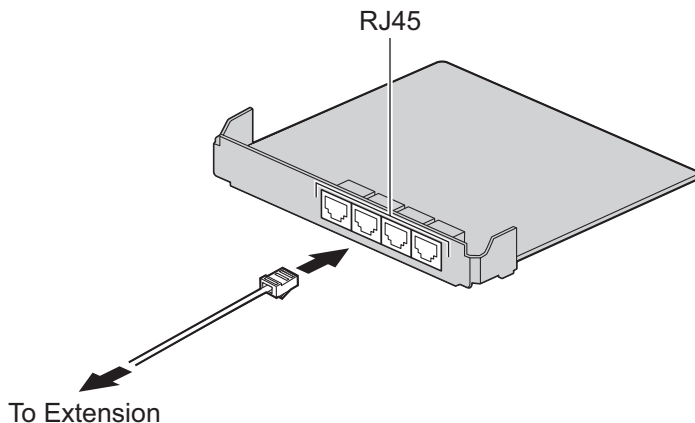

### Accessories and User-supplied Items

**Accessories (included):** Spacer × 4, slot cover × 1

**User-supplied (not included):** RJ45 connector, Twisted pair cable

### Pin Assignments

	No.	Signal Name	Function
	1	D1A	Data port 1 (Low)
	2	D2A	Data port 1 (High)
	3	D1B	Data port 2 (Low)
	4	D1C	Data port 3 (Low)
	5	D2C	Data port 3 (High)
	6	D2B	Data port 2 (High)
	7	D1D	Data port 4 (Low)
	8	D2D	Data port 4 (High)

## 4.5.6 MCSLC8 Card (KX-NS5173)

### Function

8-port extension card for SLTs with Caller ID (FSK), Message Waiting Lamp control.

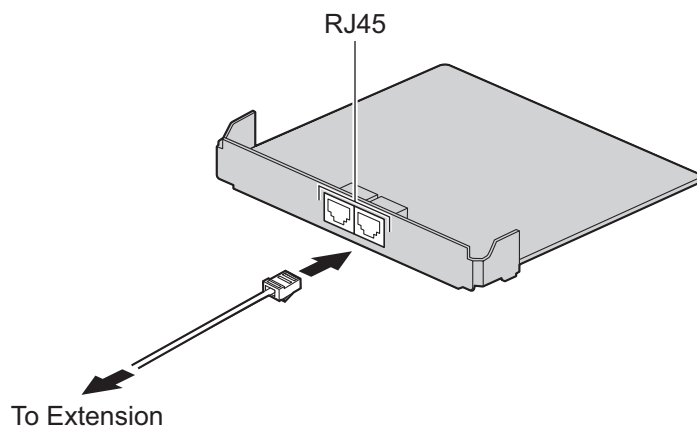

### Accessories and User-supplied Items

**Accessories (included):** Spacer × 3, slot cover × 1

**User-supplied (not included):** RJ45 connector, Copper wire

### Pin Assignments

	No.	Signal Name	Function
	1	TA	Tip port 1
	2	RA	Ring port 1
	3	TB	Tip port 2
	4	TC	Tip port 3
	5	RC	Ring port 3
	6	RB	Ring port 2
	7	TD	Tip port 4
	8	RD	Ring port 4

## 4.5.7 MCSLC16 Card (KX-NS5174)

### Function

16-port extension card for SLTs with Caller ID (FSK), Message Waiting Lamp control.

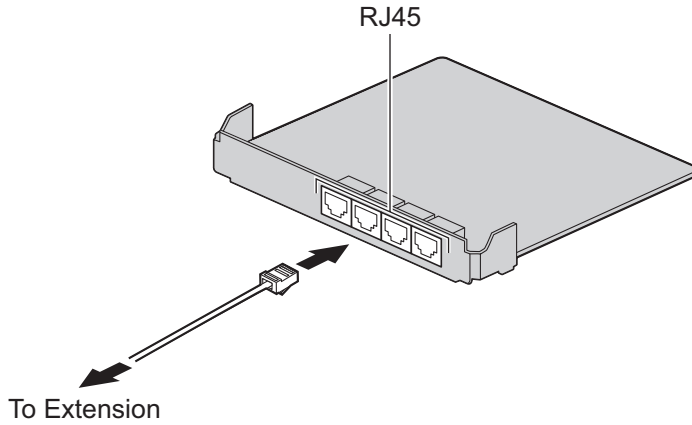

### Accessories and User-supplied Items

**Accessories (included):** Spacer × 3, slot cover × 1

**User-supplied (not included):** RJ45 connector, Copper wire

### Pin Assignments

	No.	Signal Name	Function
	1	TA	Tip port 1
	2	RA	Ring port 1
	3	TB	Tip port 2
	4	TC	Tip port 3
	5	RC	Ring port 3
	6	RB	Ring port 2
	7	TD	Tip port 4
	8	RD	Ring port 4

## 4.6 Expansion Card

### 4.6.1 EXP-M Card (KX-NS5130)

#### Function

A stacking card to be installed in a KX-NS300. Up to 3 expansion units can be connected.

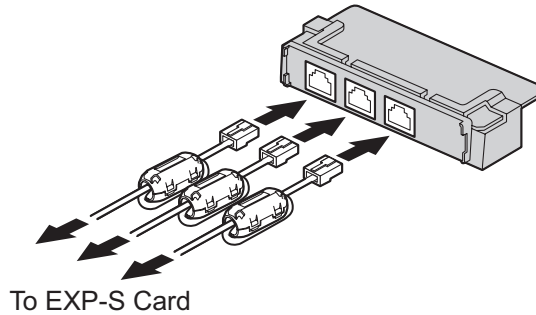

#### Accessories and User-supplied Items

**Accessories (included):** Screws × 3, slot cover × 1

**User-supplied (not included):** RJ45 connector, Twisted pair cable (maximum 3 m)

#### CAUTION

When installing or removing this card, the power switch must be turned off.

#### Notice

- When connecting the RJ45 connector, attach the ferrite core (included with the KX-NS320). Refer to "4.2.8 Attaching a Ferrite Core".

#### Note

Status LED on KX-NS320 indicates the connection status between EXP-M in KX-NS300 and EXP-S in KX-NS320.

For more detail, refer to KX-NS320 - LED Indication in "4.3.1 Mother Board".

### Pin Assignments

	No.	Signal Name	Function
	1	UHW+	Receive data +
	2	UHW-	Receive data -
	3	REFCLK+	Reference CLK +
	4	FHCLK+	Frame and System CLK +
	5	FHCLK-	Frame and System CLK -
	6	REFCLK-	Reference CLK -
	7	DHW+	Transmit data +
	8	DHW-	Transmit data -

## Maximum Cabling Length of Extension Connection

The maximum length of the extension cable that connects the Main Unit to the Expansion Unit is shown below:

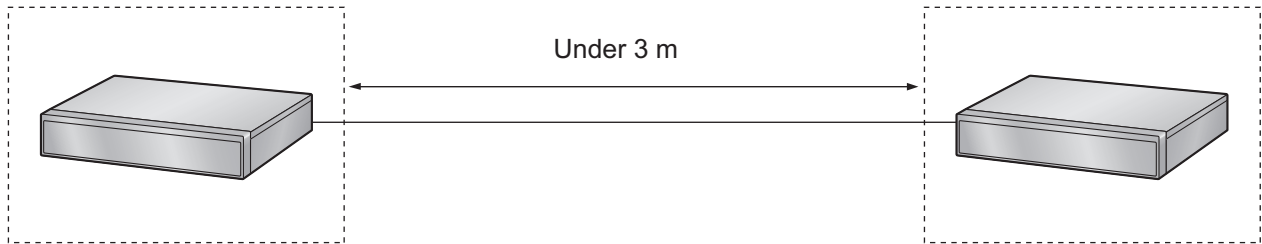



## 4.7 The Doorphone Card

### 4.7.1 DPH2 Card (KX-NS5162)

#### Function

A doorphone card for 2 doorphone, 2 door opener, and 2 external sensor.  
A Doorphone Card is installed in Trunk slot.

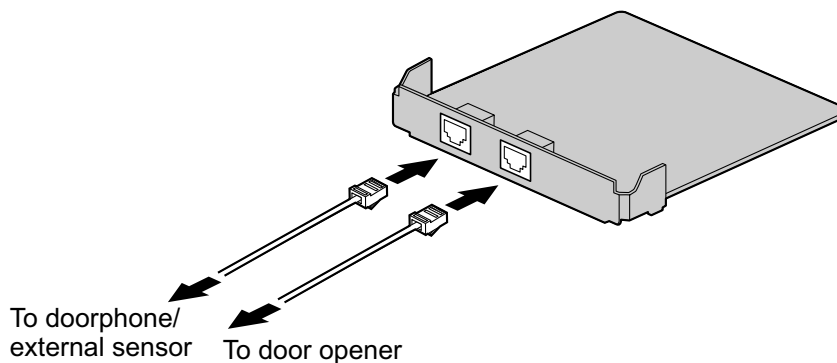

#### Accessories and User-supplied Items

**Accessories (included):** Spacer × 3, slot cover × 1

**User-supplied (not included):** Copper wire

#### Note

For details about connecting to a doorphone and/or door opener, refer to "4.9 Connecting to a Doorphone, Door Opener, and/or External Sensor".

## PIN Assignment

### PIN Assignment for Doorphone Port

	No.	Signal Name	Function
	1	DP1	Doorphone 1 transmit
	2	COM1	Doorphone 1 receive
	3	SENS1a	Sensor 1
	4	DP2	Doorphone 2 transmit
	5	COM2	Doorphone 2 receive
	6	SENS1b	Sensor 1 common
	7	SENS2a	Sensor 2
	8	SENS2b	Sensor 2 common

### PIN Assignment for Door opener Port

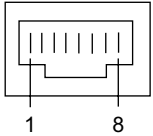
	No.	Signal Name	Function
	1	OP1a	Door opener 1 (Relay 1)
	2	OP1b	Door opener 1 com (Relay 1 com)
	3	Reserved	-
	4	Reserved	-
	5	Reserved	-
	6	Reserved	-
	7	OP2a	Door opener 2 (Relay 2)
	8	OP2b	Door opener 2 com (Relay 2 com)

### External Sensor

Power to the external sensor is provided from the DPH2 card and must be grounded through the DPH2 card as indicated in the diagram below. A pair of "sensor" and "common" lines are connected to the DPH2 card for each external sensor. The PBX detects input from the sensor when the signal is under 100 Ω.

### Connection Diagram

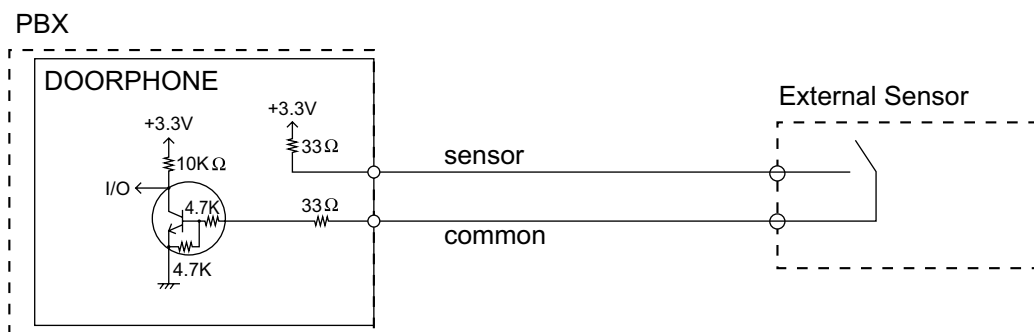

### Door Opener

Current Limit: 24 V DC/30 V AC, 1 A maximum

## 4.8 Connection of Extensions

### 4.8.1 Maximum Cabling Distances of the Extension Wiring (Twisted Cable)

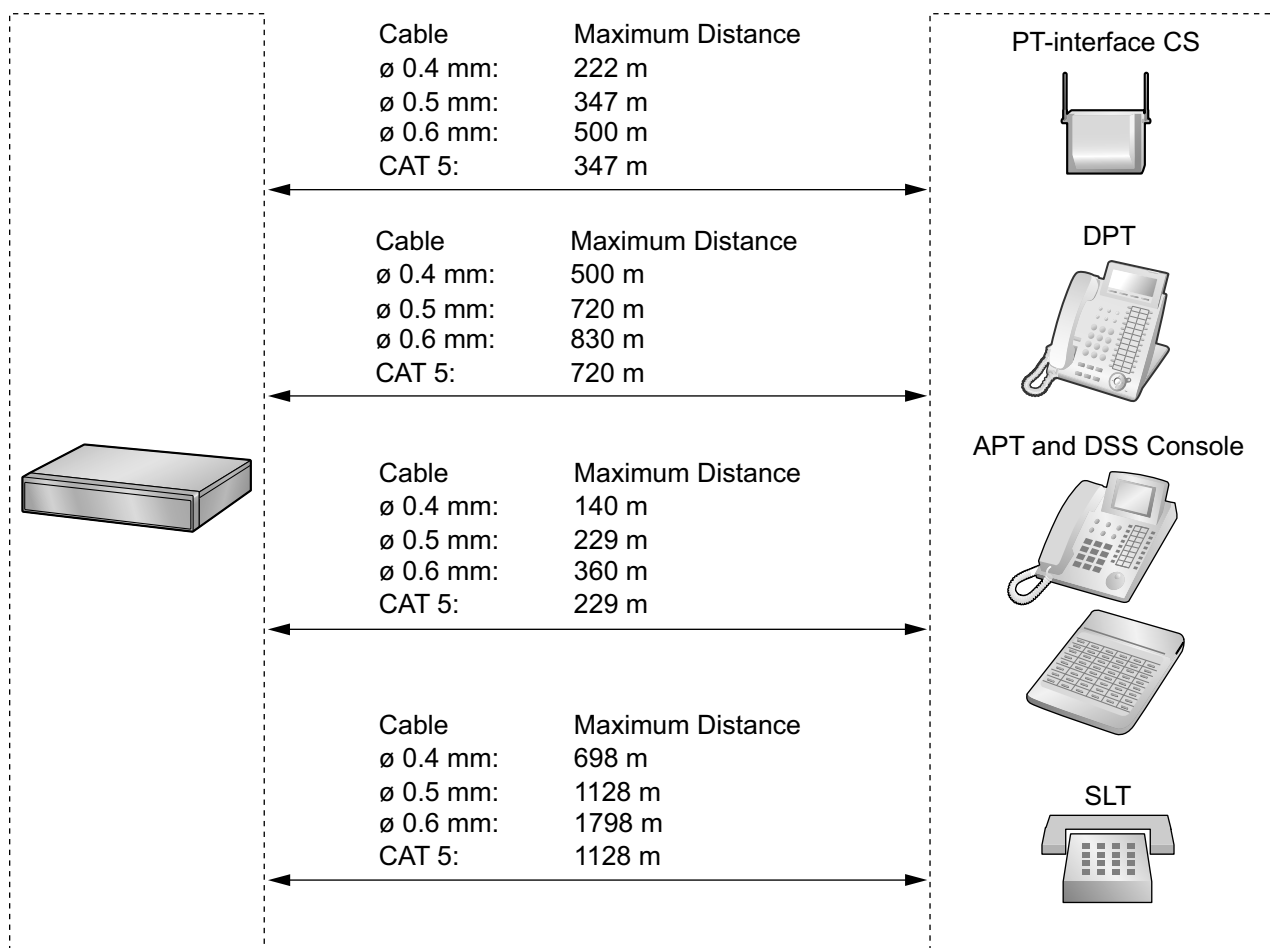

**Notice**

The maximum cabling distance may vary depending on the conditions.

	PT-interface CS	DPT	APT	DSS Console	SLT
DHLC4 Card	✓	✓	✓	✓	✓
MCSLC8, MCSLC16 cards					✓
DLC2, DLC8, DLC16 cards	✓	✓			

"✓" indicates that the extension card supports the terminal.

## 4.8.2 Parallel Connection of the Extensions

Any SLT can be connected in parallel with an APT or a DPT as follows.

### Note

In addition to an SLT, an answering machine, a fax machine or a modem (PC) can be connected in parallel with an APT or a DPT.

### With APT

For parallel connection, eXtra Device Port (XDP) mode must be disabled for that port through system programming. Refer to "2.11.10 Paralleled Telephone" and "5.2.6 Extension Port Configuration" in the Feature Guide for further information.

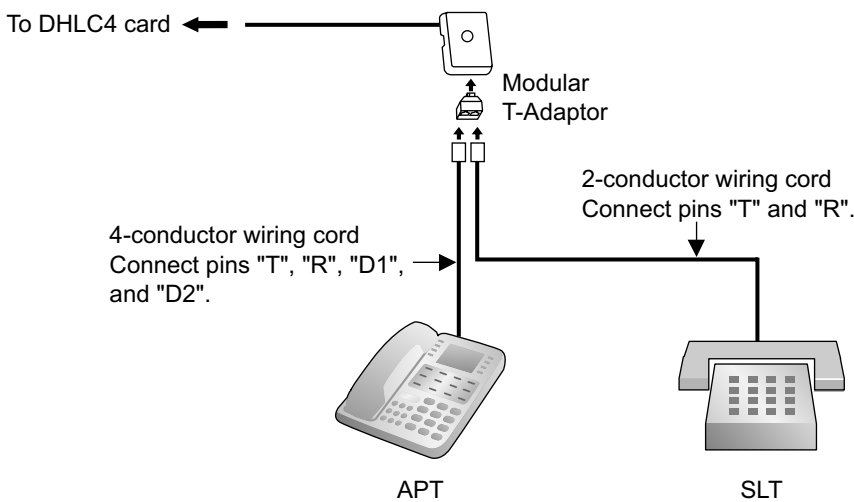

### With DPT

Parallel mode or eXtra Device Port (XDP) mode can be selected through system programming. If XDP mode is enabled through system programming, parallel connection is not possible. Refer to "2.11.10 Paralleled Telephone" and "5.2.6 Extension Port Configuration" in the Feature Guide for further information.

### Using a Modular T-Adaptor

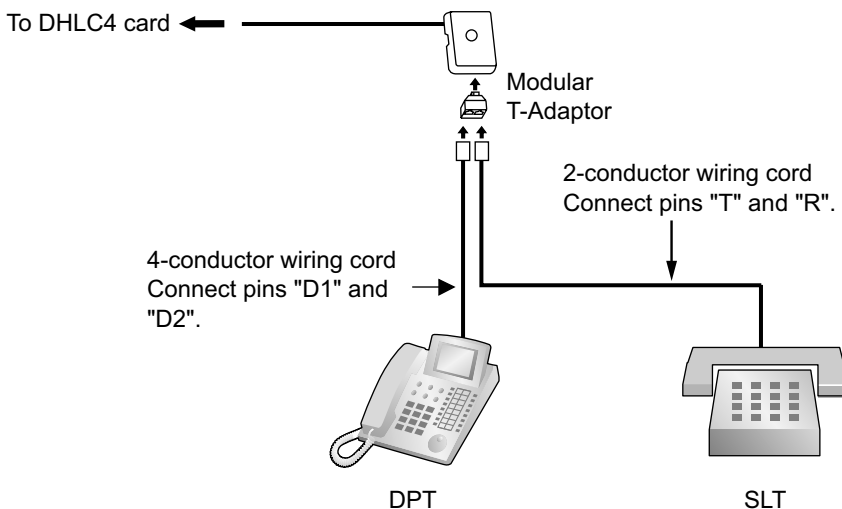

**Using an EXtra Device Port**

**Example: With KX-DT300 Series DPT<sup>\*1</sup>**

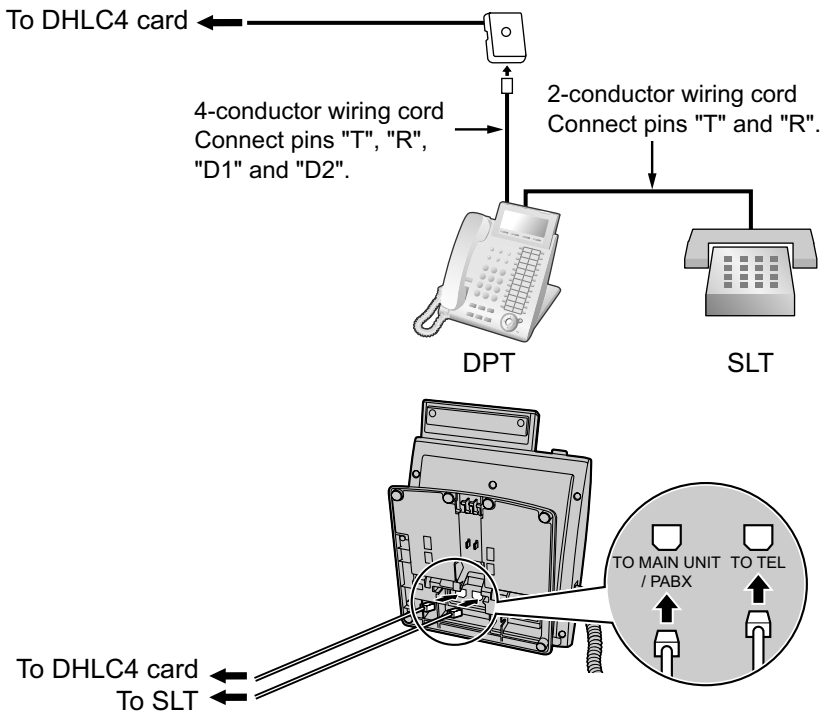

<sup>\*1</sup> Available for KX-DT300 Series DPT (except KX-DT321), KX-T7600 Series DPT (except KX-T7665) and KX-DT500 Series DPT (except KX-DT521).

### 4.8.3 Digital EXtra Device Port (Digital XDP) Connection

A DPT can be connected to another DPT on the Digital XDP connection. In addition, if the DPT is connected to a DHLC4 card, it can also have an SLT connected in Parallel mode or XDP mode.

**Note**

- Both DPTs must be KX-DT300/KX-DT500/KX-T7600 series DPTs (except KX-T7640). Note that the KX-T7667 can only be connected as a slave DPT.
- Bluetooth® Modules or USB Modules must not be connected to DPTs in the Digital XDP connection.
- Parallel mode or XDP mode can be selected through system programming.
- If XDP mode is enabled through system programming, parallel connection is not possible. Refer to "2.11.10 Paralleled Telephone" and "5.2.6 Extension Port Configuration" in the Feature Guide for further information.

#### Example: With KX-DT300 Series DPT

##### Using a Modular T-Adaptor

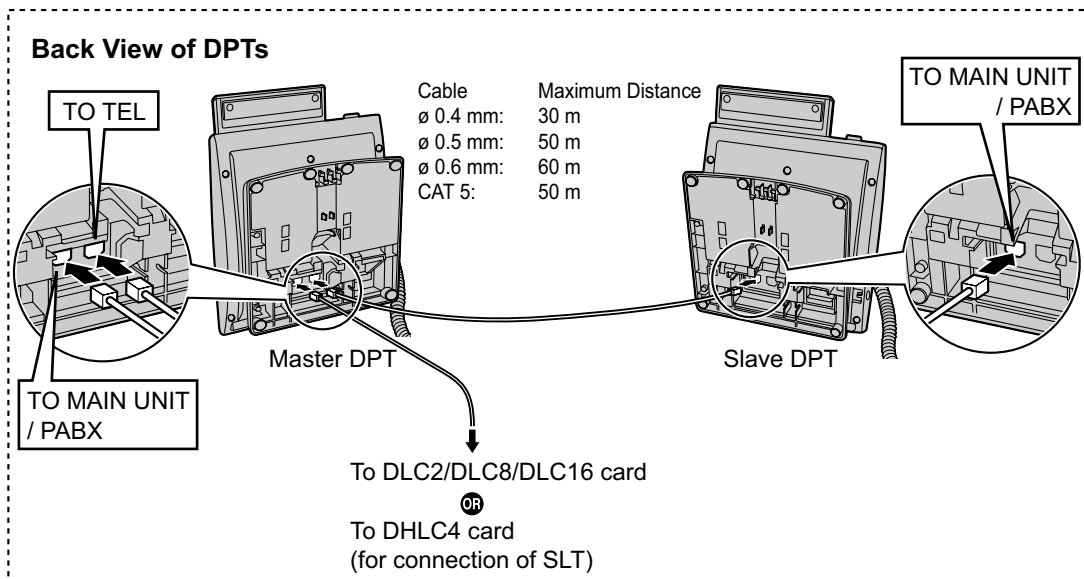
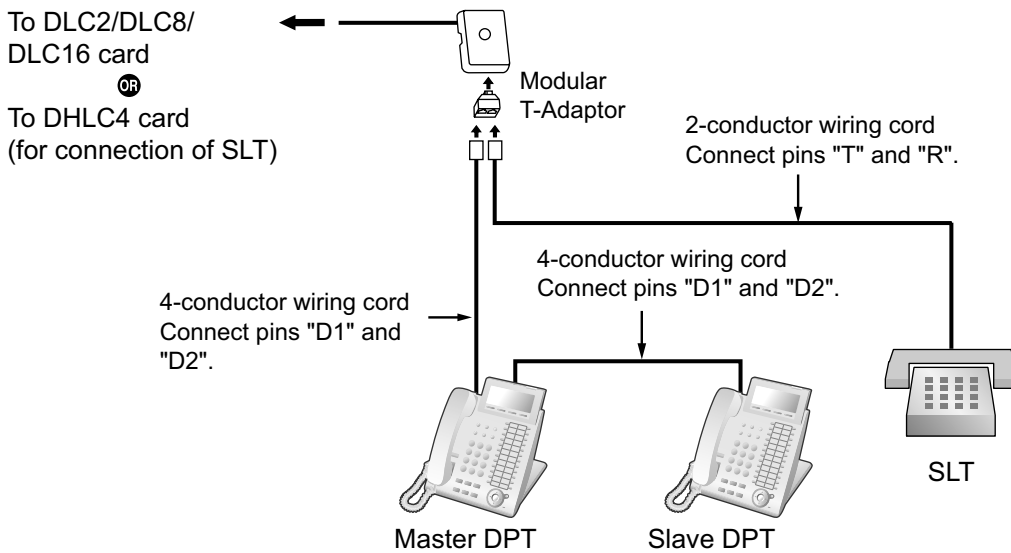

Using an EXtra Device Port\*<sup>1</sup>

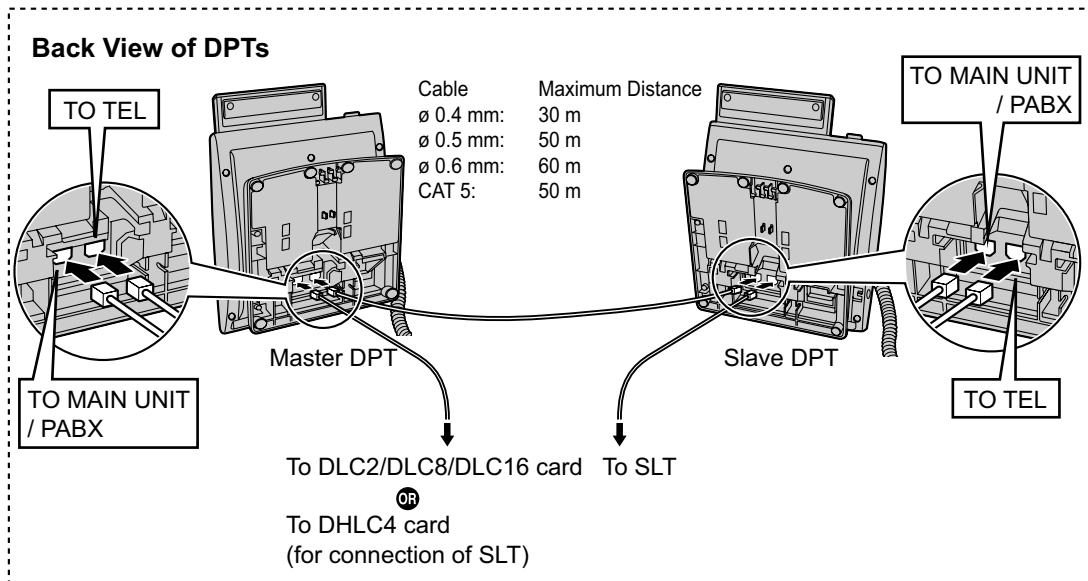
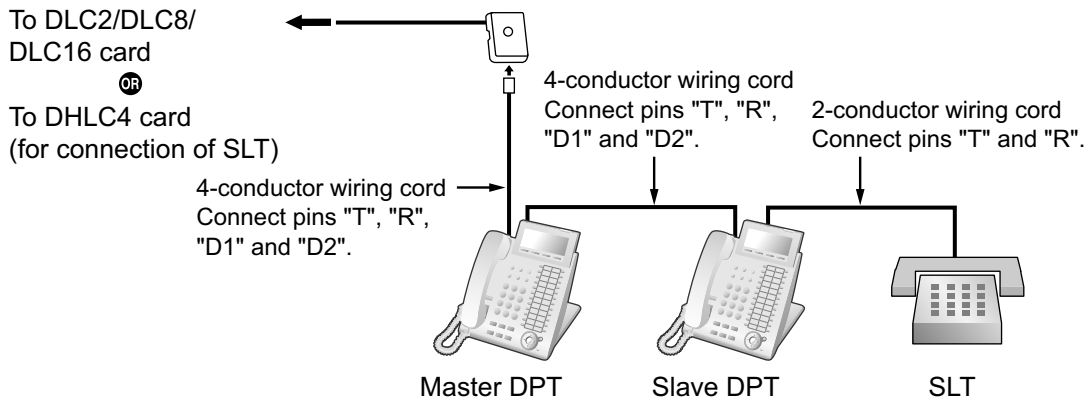

\*1 Connecting with a SLT is not available for KX-DT321, KX-T7665 and KX-DT521.

## 4.9 Connecting to a Doorphone, Door Opener, and/or External Sensor

Main unit KX-NS300 and Expansion unit KX-NS320 support 2 doorphones, 2 door openers and 2 sensors.

### Note

Doorphones, door openers, and external sensors are user-supplied.

### Maximum Cabling Distance

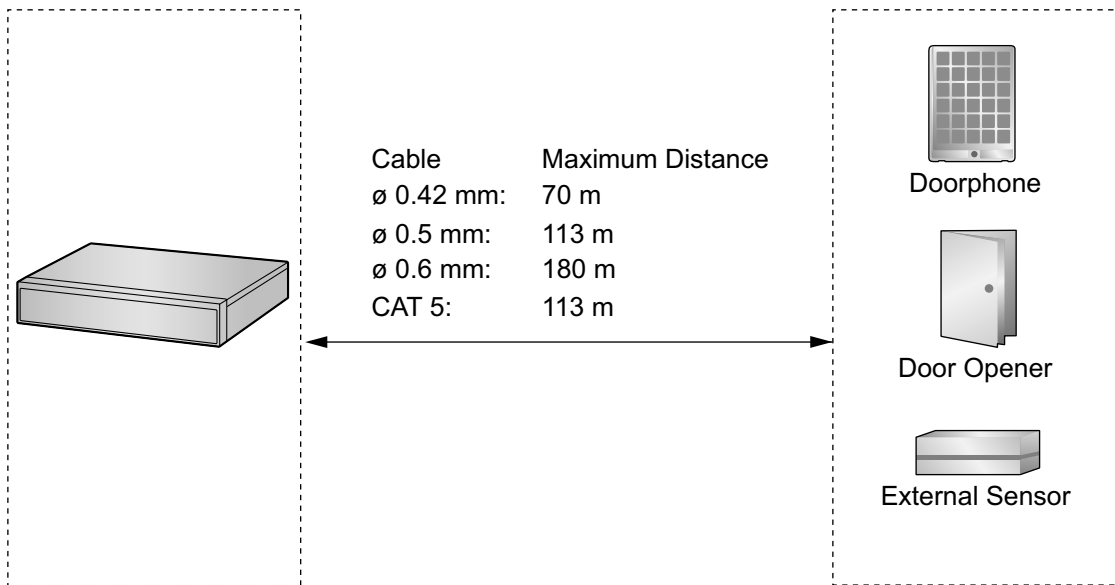

### Installing the Doorphone (KX-T30865/KX-T7765)

#### Note

The illustrations shown in the installation procedure are based on the KX-T30865.

1. Loosen the screw to separate the doorphone into 2 halves.

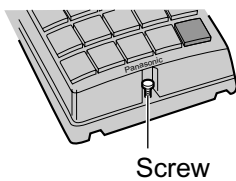



**Note for KX-T7765 Users**

When loosening/tightening the screw, do not scratch the cabinet wall with the driver shaft.

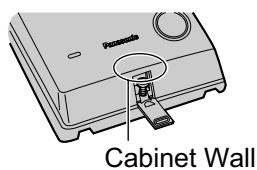

2. Pass the wires through the hole in the base cover, and attach the base cover to a wall using 2 screws.

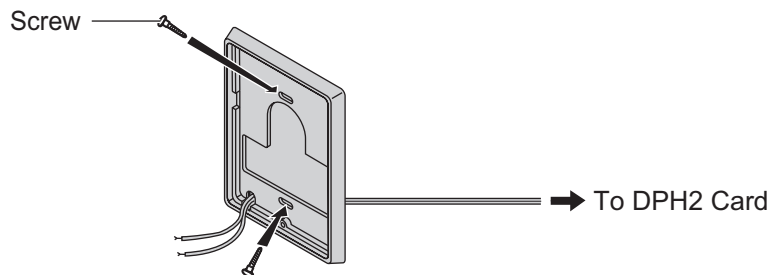

**Note**

Two kinds of screws are included with the doorphone. Please choose the appropriate kind for your wall type.



: when a doorphone plate has been fixed to the wall



: when you wish to install the doorphone directly onto the wall

3. Connect the wires to the screws located in the back cover.

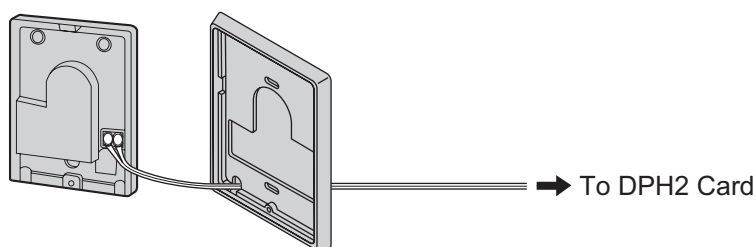

4. Re-attach the 2 halves and re-insert the screw.

**Connection**

Refer to "4.7.1 DPH2 Card (KX-NS5162)" for pin assignments.

# 4.10 Connection of Peripherals

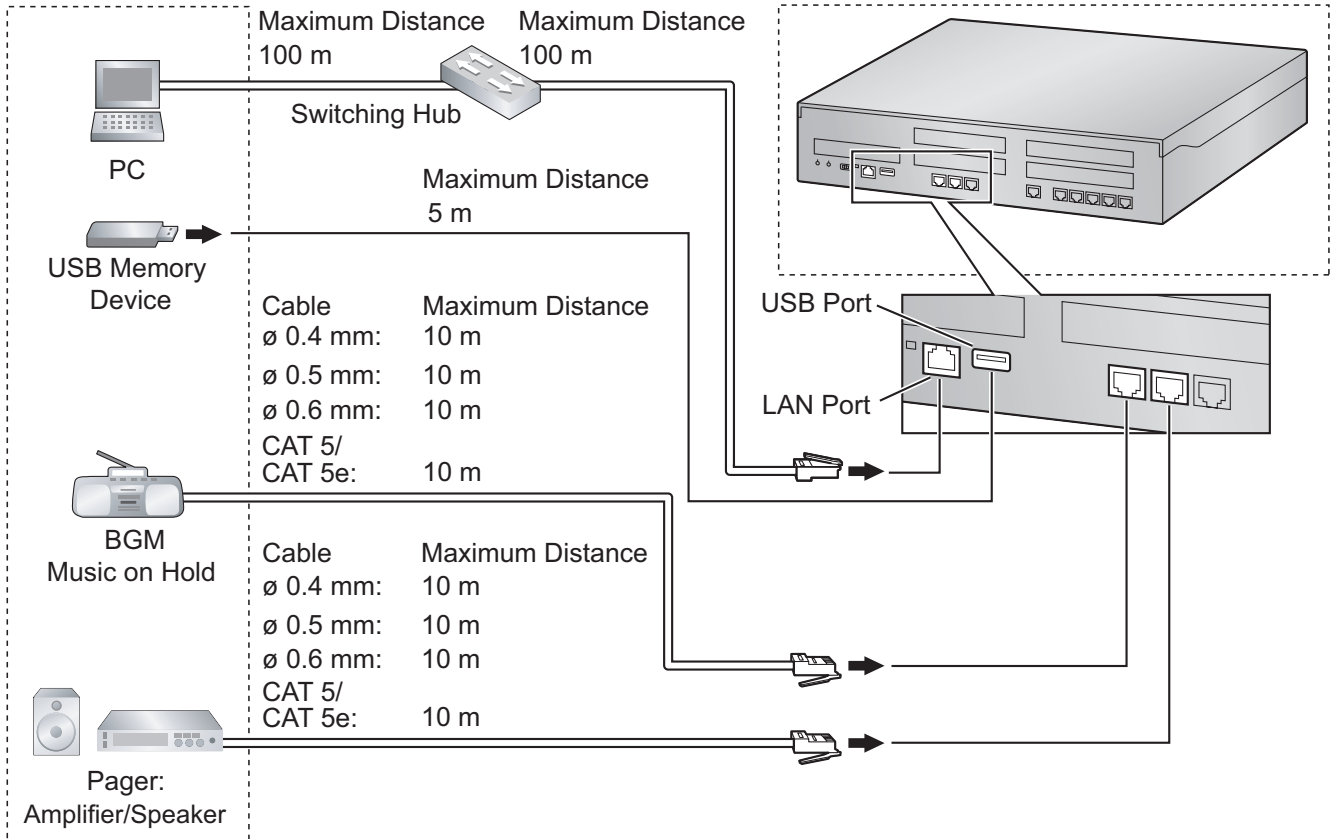

## BGM/MOH

The PBX provides Background Music and Music on Hold. Up to 6 external music sources (e.g., user-supplied radio) can be connected to the PBX.

### CAUTION

The MOH port is an SELV port and should only be connected to an approved SELV device, via a Line Isolation Unit with a Telecommunications Compliance Label.

### Notice

- Wiring should be done carefully to prevent undue force being exerted on the plug. Otherwise, sound may only be heard intermittently.
- When the PBX and external music source are not connected to the same earth, hum noise may be induced into Background Music and Music on Hold.

## Pager

A paging device (user-supplied) can be connected to the PBX.

### CAUTION

The Pager port is an SELV port and should only be connected to an approved SELV device, via a Line Isolation Unit with a Telecommunications Compliance Label.

## USB Interface for USB Memory Device

The PBX is equipped with a USB 2.0 interface. This interface provides communication between the PBX and user-supplied devices such as a USB memory device.

### Using a USB memory device

A USB memory device can be used to backup and restore the system data of the PBX.

- When you update the Main Unit software, you need to install SD card or USB memory card.

The PBX supports USB memory devices that meet the following specifications:

- File system: FAT
- Maximum capacity: 32 GB
- Maximum current: 500 mA

For details about backing up and restoring using a USB memory device, refer to "6.1 Tool—System Data Backup" in the PC Programming Manual.

### **Note**

Do not use a USB hub when connecting a USB memory device to the PBX.

# 4.11 LAN Connection

## 4.11.1 LAN Connection for the Main Unit

### Connecting the Main Unit to the LAN

The PBX is equipped with a LAN port for connecting to a LAN so that IP telephones (IP-PTs, IP softphones, SIP phones), IP-CSs, PCs and a CTI Server can be connected on a private IP network. When the PBX is connected to the LAN for the first time, you must assign IP addressing information to the PBX. See "5.4 Programming the PBX" for instructions.

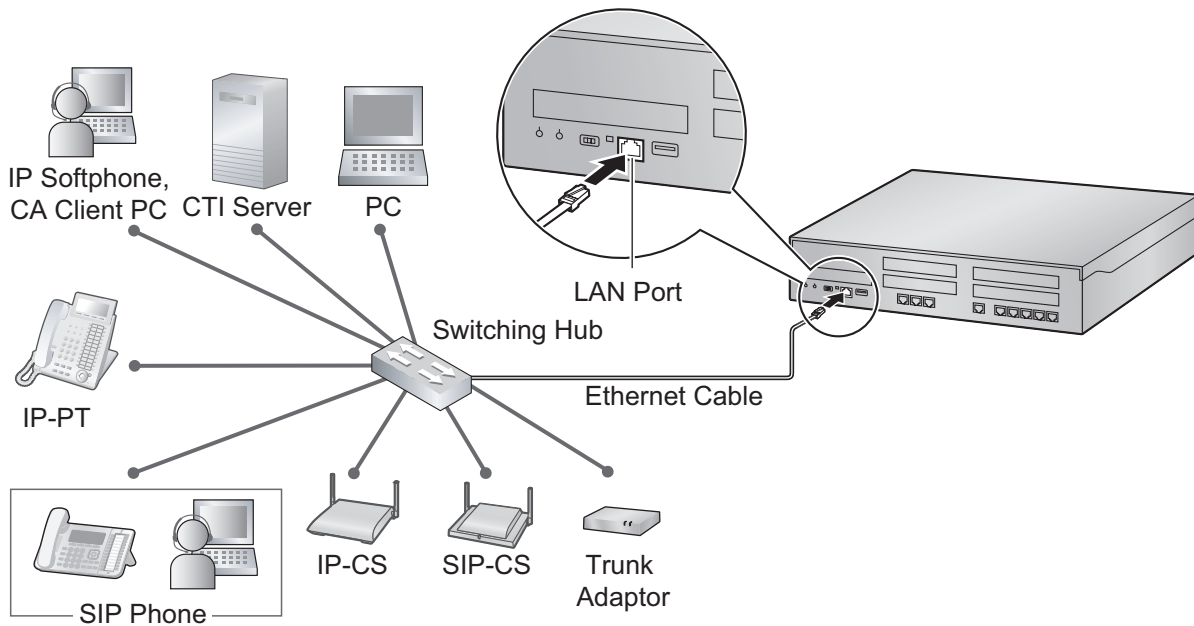

#### Connection for 10BASE-T/100BASE-TX

Switching Hub		PBX (LAN Port)	
Signal Name	Pin No.	Pin No.	Signal Name
TX+	1	1	RX+
TX-	2	2	RX-
RX+	3	3	TX+
RX-	6	6	TX-

**Note**

- Use an Ethernet cable with an RJ45 connector for connection to a switching hub. The cable should be a CAT 5 (Category 5) or higher for 10BASE-T/100BASE-TX, or CAT 5e (Enhanced Category 5).
- Make sure that all CAT 5/CAT 5e cables in use are not over 100 m in length.
- Make sure to set the port of the switching hub that connects to the card to operate under "Auto Negotiation" mode.
- Make sure to create a spanning tree for LAN connection in order to prevent loops from occurring in a multi-bridged environment. Otherwise, some packets may circulate for long periods of time and eventually PBX performance system may degrade.

- The CTI server can be used for connecting PCs on a LAN to provide third party call control CTI. CTI connection uses the CSTA Phase 3 or TAPI 2.1 protocol. The operating system of the PC or CTI server required for third party call control depends on your CTI application software. For details, refer to the manual for your CTI application software.
- When using the VLAN feature on the network, make sure that the PBX is connected to a layer 2 switch that is IEEE 802.1Q compliant, and that is configured for VLANs. In addition, the port of the switching hub to which the PBX is connected must be set to "Untagged". Consult your network administrator for details.

## 4.11.2 LAN Connections for IP Telephones

When an IP telephone is connected to the LAN and power is supplied for the first time, you will be prompted to set network parameters. The network parameters must be set for the IP telephone before it can be used. Refer to "5.7 Assigning Networking Information to IP Telephones" for instructions.

### Connecting an IP Telephone to a Switching Hub

When connecting an IP telephone to the LAN, connect it to a switching hub.

#### Note

- Use an Ethernet straight cable with an RJ45 connector to connect the IP telephone to a switching hub. The cable should be a CAT 5 (Category 5) or higher for 10BASE-T/100BASE-TX, or CAT 5e (Enhanced Category 5).
- When using the VLAN feature on the network, make sure that the switching hub to be connected is IEEE 802.1Q compliant and is configured for VLANs. In addition, the port of a switching hub that the IP telephone is connected to must be set to "Trunk" port, to allow VLAN tagging. Consult your network administrator for details.
- Since an IP softphone is installed and operates on a PC, the PC must be connected to the LAN to use the IP softphone on the network.

The diagram below is for connecting an IP-PT to a switching hub. For SIP phones, refer to the documentation of your SIP phone.

#### Example: KX-NT346

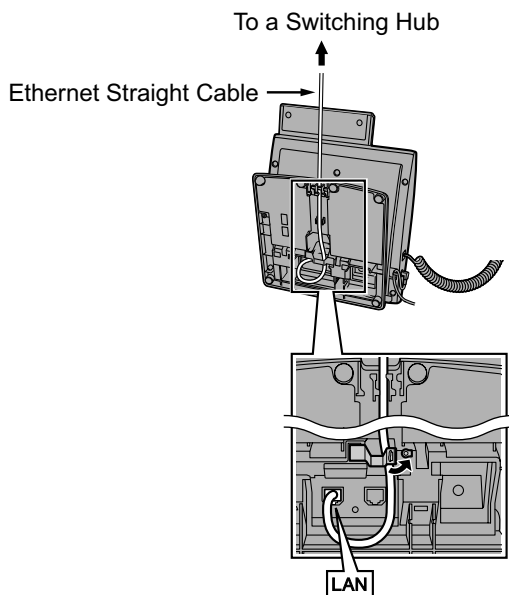

## Connecting an AC Adaptor to an IP Telephone

IP-PTs and some SIP phones comply with the IEEE 802.3af Power-over-Ethernet (PoE) standard. If PoE is available on your network, these IP telephones can receive the necessary power supply from the network through the network cable. In this case, no AC adaptor is needed for the IP telephones.

However, if PoE is not available, you will need to connect an AC adaptor to the IP telephone.

### Note

Use only the specified type of AC adaptor for each IP telephone. For details, refer to the documentation of your IP telephone.

### Example: KX-NT346

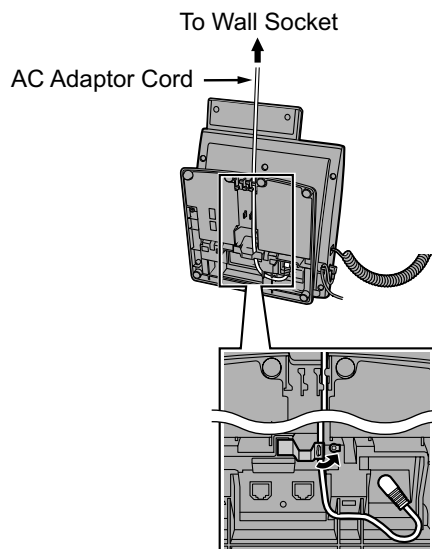

## Connecting a PC to an IP Telephone

You can connect a PC to some IP telephones (e.g., KX-NT300 series) using the IP telephone's secondary port. In this case, only a single port from the LAN's network interface (switching hub) is required to connect both the IP telephone and PC to the LAN.

### Note

- Use an Ethernet straight cable with an RJ45 connector to connect a PC to the IP telephone. The cable should be a CAT 5 (Category 5) or higher for 10BASE-T/100BASE-TX, or CAT 5e (Enhanced Category 5).
- Only a PC can be connected to the secondary port of an IP telephone. Other IP telephones, including IP-PTs, or network devices such as routers or switching hubs, cannot be connected.
- The secondary port does not support PoE for connected devices.
- In cases where a PC is connected to the secondary port, if the IP telephone connection to the PBX is disconnected or reset, LAN communication to the PC will also be disrupted.
- Generally, it is recommended that you connect no more than one PC to the secondary port of each IP telephone.

#### 4.11.2 LAN Connections for IP Telephones

---

##### Example: KX-NT346

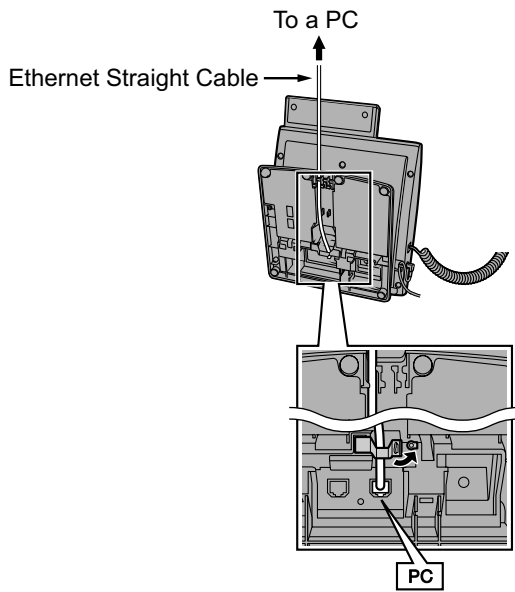



## 4.12 Power Failure Connections

When the power supply to the PBX and/or Expansion Unit fails, power failure transfer (PFT) will switch from the current connection to the Power Failure Connection. Refer to "5.6.2 Power Failure Transfer" in the Feature Guide for further information.

The table below shows PFT support Cards and PFT support ports.

	PFT support Cards	PFT support ports
KX-NS300	Pre-installed LCOT6	Port 1-2
	Pre-installed MCSLC16	Port 1-2
KX-NS320	Optional card KX-NS5180	Port 1-4
	Pre-installed MCSLC16	Port 1-4

The table below shows the maximum number of PFT connections for each stacking configurations.

KX-NS300 (Pre-installed)	KX-NS300 (Maximum)	KX-NS300 w/1 KX-NS320	KX-NS300 w/2 KX-NS320s	KX-NS300 w/3 KX-NS320s
2	2	6	10	14

### Note

A trunk conversation established during power failure can be maintained even when the power returns and the connection is switched back to the normal configuration from the Power Failure Connection.

### Power Failure Connection

#### In the case of KX-NS300

In the event of a power failure, a specific SLT port is automatically supplied power through the CO port. The PFT ports are the port 1-2 (on pre-installed MCSLC16) and port 1-2 (on pre-installed LCOT6).

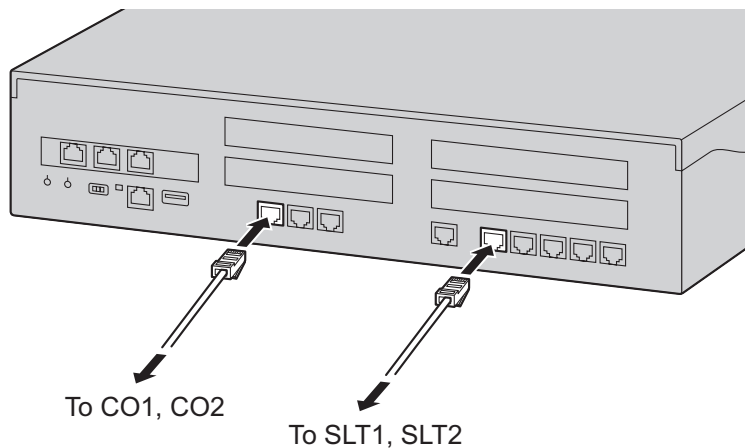

**In the case of KX-NS320**

In the event of a power failure, a specific SLT port is automatically supplied power through the CO port. The PFT ports are the port 1-4 (on pre-installed MCSLC16) and port 1-4 (on Optional LCOT6 card) through PFT card.

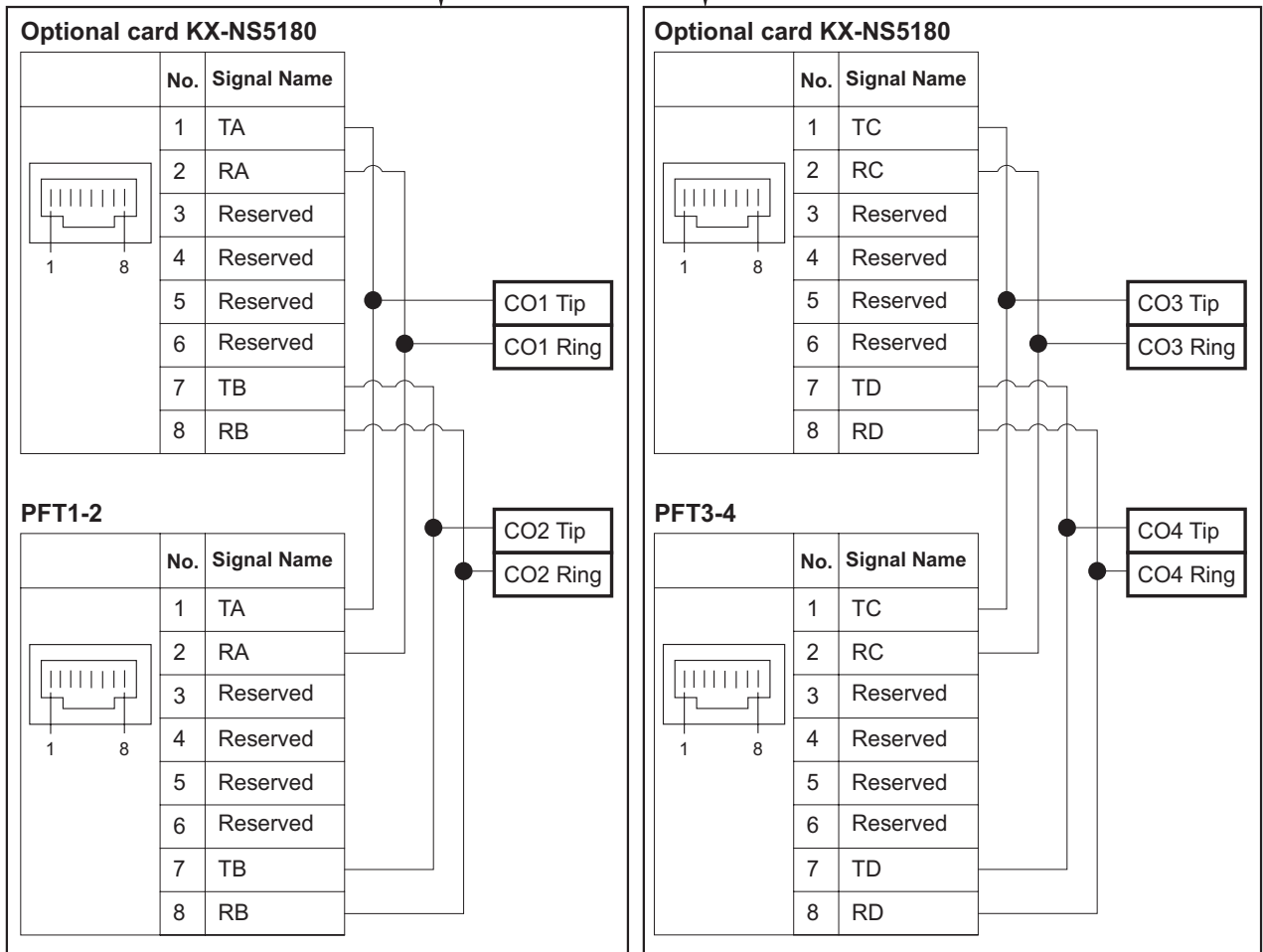
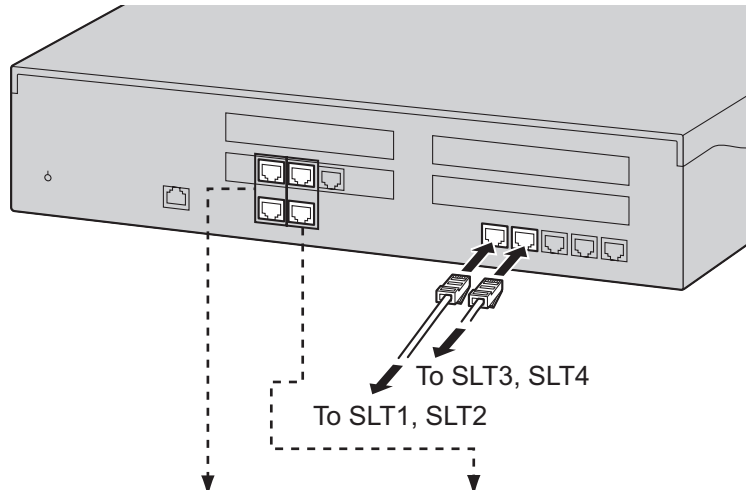

## 4.13 Starting the KX-NS300

### **WARNING**

Make sure that the AC outlet is properly earthed, then securely connect the 3-pin AC plug including the earthed pin.

### **CAUTION**

- Use only the AC power cord included with the PBX.
- Before touching the product (PBX, cards, etc.), discharge static electricity by touching ground or wearing an earthing strap. Failure to do so may cause the PBX to malfunction due to static electricity.
- Once you have started the PBX, if you unplug the PBX, do not initialise it again as described in "System Initialisation Procedure". Otherwise, your programmed data will be cleared. To restart the PBX, refer to "7.1.5 Restarting the KX-NS300".
- The plug of power supply cordset is used as the main disconnect device. Ensure that the AC outlet is located near the equipment and is easily accessible.

### Installing the Hook Clip for the AC Power Cord

1. Insert the hook clip into the hook clip hole.

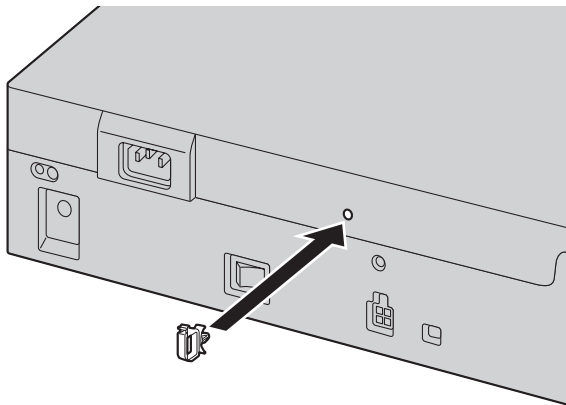

### **Note**

Use only the hook clip included with the PBX.

## Connecting the AC Power Cord

1. Plug the AC power cord into the PBX and pass the cord through the hook clip as indicated. Push the hook clip in the direction of the arrow until it clicks.

### Note

For safety reasons, do not stretch or pinch the AC power cord.

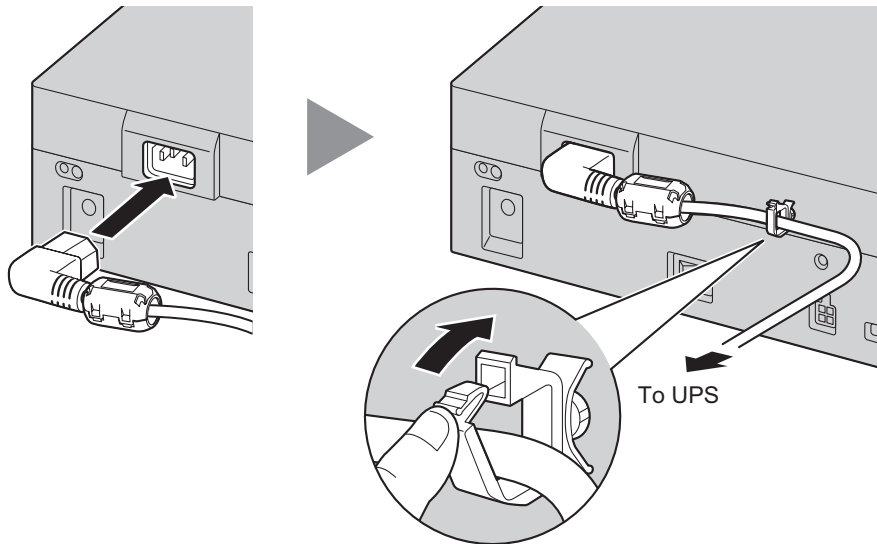

2. **When not using a UPS:**  
Plug the other end of the cord into an AC outlet.  
**When using a UPS:**  
Plug the other end of the cord into the outlet of the UPS.

## System Initialisation Procedure

1. Slide the System Mode Switch to the "SYSTEM INITIALIZE" position.

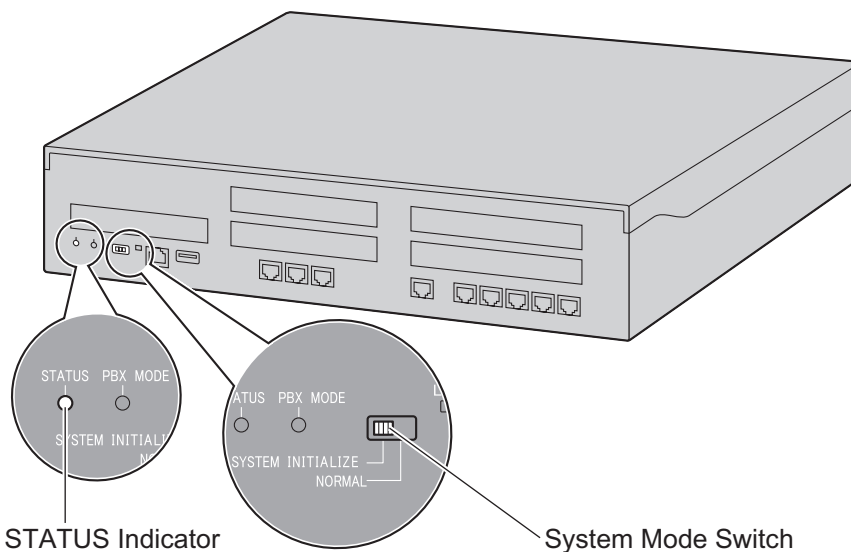

2. Turn on the power switch of the PBX. The STATUS indicator will flash green.

3. While the STATUS indicator is flashing green, slide the System Mode Switch back to the "NORMAL" position. Depending on the configuration, initialisation takes about 2.5 minutes. If successfully executed, the STATUS indicator will stop flashing and remain lit up.

**Note**

When a DSP card is installed and a DHCP server is not connected, installed DSP card cannot acquire an IP address, and the STATUS indicator will turn red.

All data, except for system prompts and activation key files, will be erased. Data that is erased includes Unified Messaging data, call logs, etc. The settings for the PBX as well as all optional service cards will be initialised to their default values.

**Note**

- After the PBX is initialised, you can restore system data to the PBX that has been backed up earlier. For details about backing up and restoring system data, refer to "6.1 Tool—System Data Backup", "7.2.2 Utility—File—File Transfer PBX to PC" and "7.2.1 Utility—File—File Transfer PC to PBX" in the PC Programming Manual.
- After the PBX is initialised, you must set up the mandatory settings required for the PBX with Easy Setup Wizard. For details refer to "Connecting to Web Maintenance Console" and "5.4.1 Easy Setup Wizard".
- When a UPS is connected, make sure it is started as instructed in the documentation for the UPS.

## Confirming the Trunk Connection

After the PBX starts up, programme the PBX and connect trunks to the PBX.

To confirm that the trunks are successfully connected, dial [\*] [3] [7] + trunk number (3 digits) on an IP telephone, or press the IP/DPT/APT telephone's S-CO button. You will hear a dial tone if the trunk is available and connected.

#### 4.13 Starting the KX-NS300

---

---

## **Section 5**

# ***Programming Information***

*This section describes the installation procedure, structure, and functions of the Web Maintenance Console for programming IP telephones and the PBX. Further information on programming the PBX for use with SIP trunks and a VoIP network is included.*

# 5.1 Overview of Web Maintenance Console

Web Maintenance Console is designed to serve as an overall system programming reference for the PBX. You can programme and control the PBX over an IP network using Web Maintenance Console. This section describes programming basic items using Web Maintenance Console.

Web Maintenance Console Features

Login Status

Menu Buttons

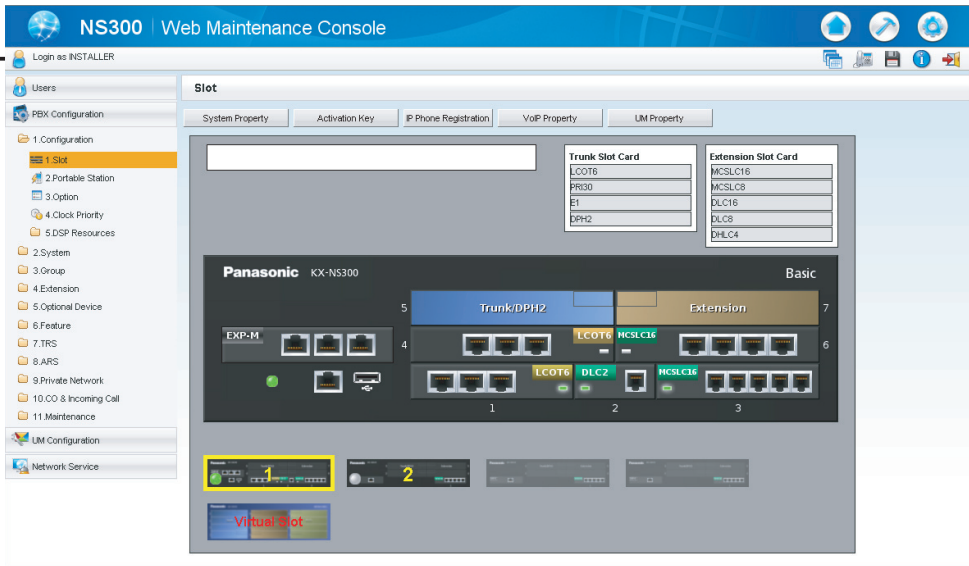

**Note**

The contents and design of the software are subject to change without notice.



## 5.2 PC Connection

KX-NS300 has a LAN port for PC to programme PBX. A default IP address is assigned to each port. A PC can be connected through LAN connection.

Port	Default IP Address	Default Subnet Mask
LAN Port	192.168.0.101	255.255.255.0
MNT Port	223.0.0.1	

### Connection via LAN

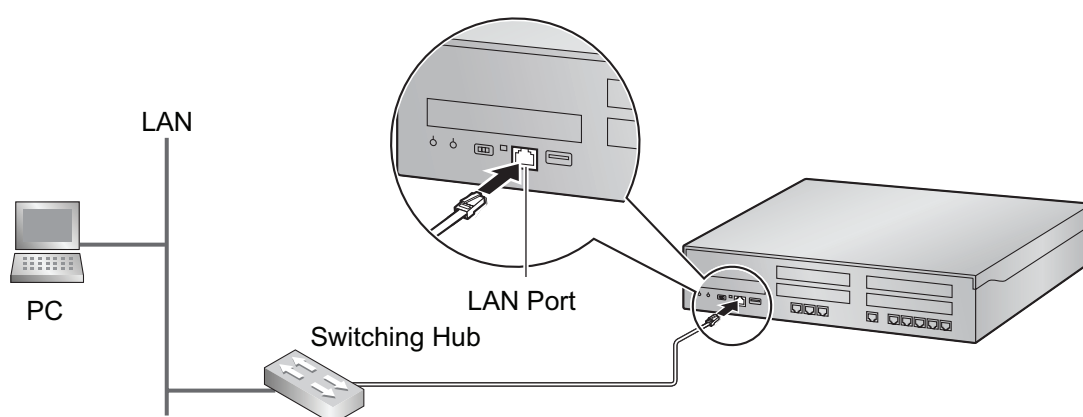

#### Note

For details about connecting a switching hub to the PBX, refer to "4.11.1 LAN Connection for the Main Unit".

### Connection via Virtual Private Network (VPN)

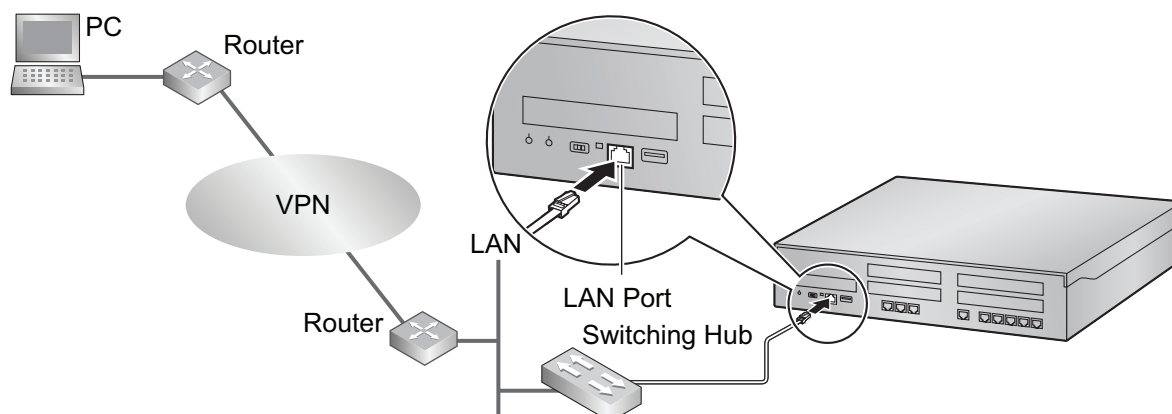

#### Notice

To access the PBX via VPN, the PC must be in the same VPN.

**Note**

For details about connecting a switching hub to the PBX, refer to "4.11.1 LAN Connection for the Main Unit".

**Connection via Internet**

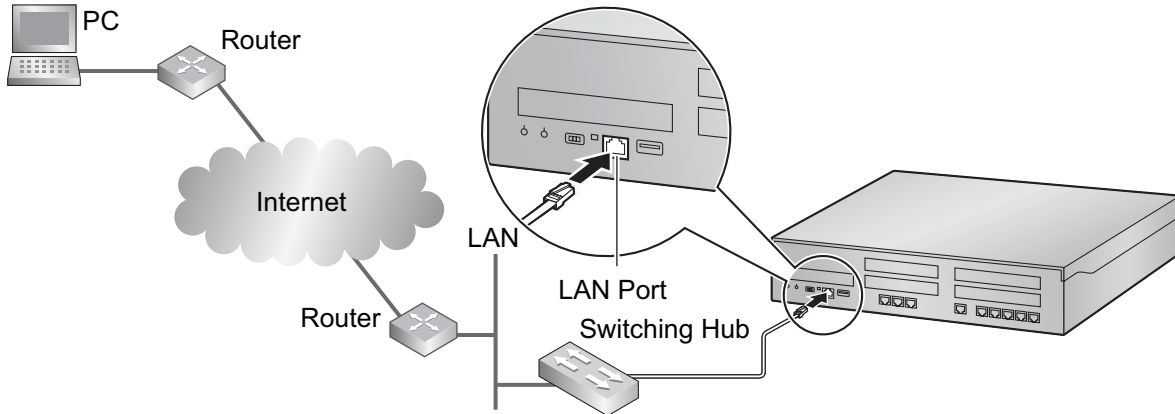

**CAUTION**

It is strongly recommended to use SSL encrypted communication when the PC is accessing the PBX via the Internet. To use SSL encryption, routers must have a port set up for https communication.

**Notice**

To access the PBX via the internet, routers must have static NAT/NAPT settings (Port forwarding) enabled.

**Note**

For details about connecting a switching hub to the PBX, refer to "4.11.1 LAN Connection for the Main Unit".

**Connection via RMT Card (KX-TDA0196)**

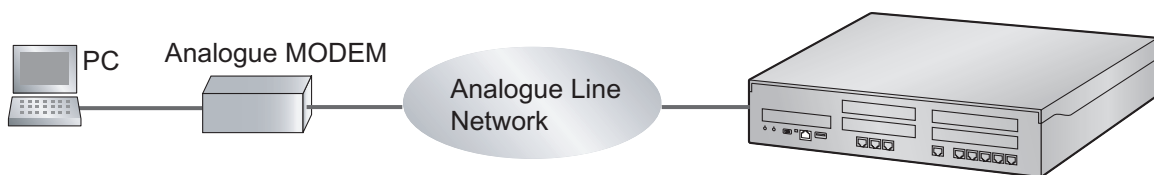

RMT Card (KX-TDA0196) is Installed in KX-NS300.

**To connect a PC to the KX-NS300**

1. Start **Off-line WebMC launcher**.
2. Click the **Connect-Online Mode(C)** button.
3. Select **Modem** tab.
4. Set following.
  - Dial Number
  - Dial NumberType
  - Port

- Baud Rate (bps)
  - Flow Control
  - Command
5. Enter **Password**.
  6. Click **Connect** button.

## Connection via PRI30/E1 Card (KX-NS5290CE)

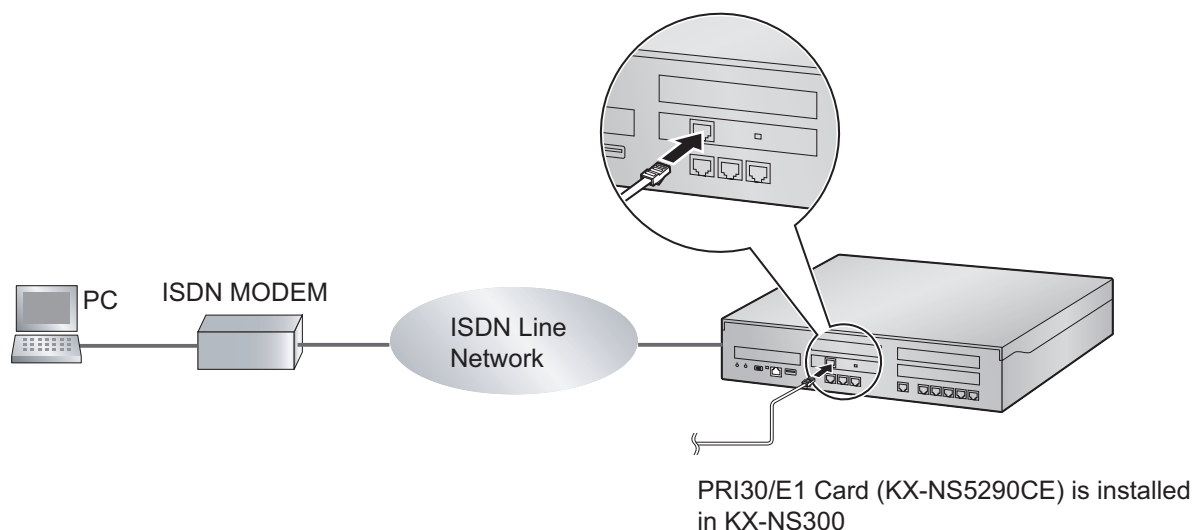

### To connect a PC to the KX-NS300

1. Start **Off-line WebMC launcher**.
2. Click the **Connect-Online Mode(C)** button.
3. Select the **ISDN Remote** tab.
4. In **Telephone Number**, enter a telephone number.
5. In **Password**, enter the password.
6. Click the **Connect** button.

## MNT Port

By connecting a USB-LAN adaptor to the USB port you can access the PBX over a LAN.

### Notice

- When connecting the PC to the MNT port, if the PC is set to obtain the IP address automatically, the IP address of the PC will be set to an appropriate IP address to establish a connection to the PBX.
- Only recommended USB-LAN adaptors can be used. For information on recommended products, consult your dealer.

## 5.3 Starting Web Maintenance Console

### System Requirements

#### Required Operating System

- Microsoft® Windows® XP, Windows Vista® Business, Windows 7, Windows 7 Professional, Windows 8 or Windows 8 Professional operating system

#### Recommended Display Settings

- Screen resolution: XGA (1024 × 768)
- DPI setting: Normal size (96 DPI)

#### Supported Browsers for use with Web Maintenance Console

- Windows Internet Explorer® 8
- Windows Internet Explorer 9
- Mozilla® Firefox® version 21 or later

#### Note

Always be sure to apply the latest updates to your Web browser software. For details, refer to your Web browser's documentation. Only the browsers and browser versions listed above are supported for use with Web Maintenance Console.

### Copyright for MD5

This software uses the Source Code of RSA Data Security, Inc. described in the RFC1321 (MD5 Message-Digest Algorithm).

Copyright (C) 1991-2, RSA Data Security, Inc. Created 1991. All rights reserved.

Licence to copy and use this software is granted provided that it is identified as the "RSA Data Security, Inc. MD5 Message-Digest Algorithm" in all material mentioning or referencing this software or this function.

Licence is also granted to make and use derivative works provided that such works are identified as "derived from the RSA Data Security, Inc. MD5 Message-Digest Algorithm" in all material mentioning or referencing the derived work.

RSA Data Security, Inc. makes no representations concerning either the merchantability of this software or the suitability of this software for any particular purpose. It is provided "as is" without express or implied warranty of any kind.

These notices must be retained in any copies of any part of this documentation and/or software.

### Password Security

#### CAUTION

##### To the Administrator or Installer regarding the system password

1. Please provide all system passwords to the customer.
2. To avoid unauthorised access and possible abuse of the PBX, keep the passwords secret, and inform the customer of the importance of the passwords, and the possible dangers if they become known to others.
3. The PBX has default passwords preset. For security, change these passwords the first time that you programme the PBX.
4. Change the passwords periodically.

5. It is strongly recommended that passwords of 10 numbers or characters be used for maximum protection against unauthorised access. For a list of numbers and characters that can be used in system passwords, refer to "1.1.3 Entering Characters" in the PC Programming Manual.

## Connecting to Web Maintenance Console

1. Connect the PC to the PBX:
  - Connect the PBX to a network with the LAN port and access the PBX from a PC in your LAN or VPN. For details, refer to "Connection via LAN", "Connection via Virtual Private Network (VPN) " and "4.11.1 LAN Connection for the Main Unit".
  - Connect the PBX to a network with the LAN port and access the PBX from a PC using an Internet connection. For details, refer to "Connection via Internet" and "4.11.1 LAN Connection for the Main Unit".
  - Connect the PBX to a PC through analogue remote (RMT card) or ISDN remote. For detail, refer to "5.5.2 PC Programming" in the Feature Guide.
2. Access Web Maintenance Console:

### LAN or VPN Connection:

Launch your Web browser and input the IP address of the PBX followed by the Web Maintenance Console port number into the address bar. The input method will differ according to the PC's connection to the PBX. The default IP address for the LAN port of the PBX is 192.168.0.101, and the default Web Maintenance Console port number is 80. Accordingly, the address to enter to connect to the PBX for the first time will be as follows (enter the address exactly as shown):

**http://192.168.0.101**

#### Note

The default subnet mask for the LAN port is 255.255.255.0.

### MNT Port Connection:

Launch your Web browser and in the address bar, enter one of the following addresses exactly as shown:

– **223.0.0.1**

or

– **http://kx-ns300.**

#### Note

- If entering "http://kx-ns300.", be sure to include the period at the end as shown.
- The default subnet mask for the MNT port is 255.255.255.0.
- If it takes a long time to connect when 223.0.0.1 is entered, configure a static IP address to the LAN connected to the PC.

### Internet Connection (SSL Connection):

When the PC is accessing the PBX from a connection over the internet, the use of SSL is strongly recommended. When using an SSL encrypted connection, the default port is 443. The format of the address to enter to connect to the PBX using an SSL encrypted connection will be as follows:

**https://xxx.xxx.xxx.xxx:yyy**

- "**xxx.xxx.xxx.xxx**" is the IP address of a device that can be accessed from the Internet, such as the IP address of a network router.
- "**yyy**" is a port number. The network router's port forwarding settings must be configured so that traffic arriving at port "yyy" is forwarded to the correct IP address and port of the PBX in the LAN.
- Port forwarding settings must specify the IP address and the port number of the network router ("**xxx.xxx.xxx.xxx:yyy**") to transfer the packets to the PBX in the LAN, so that the packets sent to the global IP address and specified port of the router will be transferred to the IP address and specified port of the PBX in the LAN.

### 5.3 Starting Web Maintenance Console

---

- Note the usage of "https" instead of "http".
- If you connect to Web Maintenance Console using SSL, a security alert window is displayed. Follow the prompts to install a security certificate. The procedure may vary according to your browser.

#### **Note**

The IP address and Web Maintenance Console port number for the PBX can be changed from their default values. If settings for the LAN port's IP address has been forgotten, refer to the PT Programming [991] in PT Programming Manual.

3. The Web Maintenance Console login screen is displayed. Log in with the Installer level account name and the default Installer level account password to launch the Easy Setup Wizard. For details about the Easy Setup Wizard, see "5.4.1 Easy Setup Wizard".

## Using Web Maintenance Console in Off-line Mode

You can connect a PC to the PBX to programme the PBX using Web Maintenance Console (On-line mode), or you can programme the PBX without connecting the PC to the PBX (Off-line mode).

Off-line mode programming is performed using the Off-line version of Web Maintenance Console, which you install on your PC. The changes made during Off-line mode are saved as local data on the PC, and then later uploaded to the PBX.

The following procedures outline how to install the Web Maintenance Console for Off-line mode programming.

### Installation

#### **Note**

- Be sure to install the latest version of KX-NS Unified Web Maintenance Console.
- Before beginning the installation of Off-line Web Maintenance Console, the following software must be installed on the PC:
  - Microsoft .NET Framework 2.0
  - Microsoft .NET Framework 4

This software can be downloaded from Microsoft's online Download Centre.

- To install or uninstall the software on a PC running Windows XP Professional, you must be logged in as a user in either the "Administrators" or "Power Users" group.
- To install or uninstall the software on a PC running Windows Vista Business, Windows 7, Windows 7 Professional, Windows 8 or Windows 8 Professional, you must be logged in as a user in the "Administrators" group.

1. Copy the KX-NS Unified Web Maintenance Console setup file to your PC.
2. Double-click the setup file to run the installer.
3. Follow the on-screen instructions provided by the installation wizard.

#### **Note**

For information about programming the PBX in Off-line mode, refer to the PC Programming Manual.

## Converting KX-TDA100/KX-TDA200 or KX-TE series System Data for Use with the KX-NS300

System data from a KX-TDA100/KX-TDA200 or KX-TE series PBX can be converted for use with the KX-NS300 to ensure a seamless transition to the new system.

In this section, we use "Maintenance Console" for the following Maintenance Console.

- Unified Maintenance Console for KX-TDA100/KX-TDA200
- Maintenance Console for KX-TE<sub>x</sub>824

1. Connect a PC to a KX-TDA100/KX-TDA200 or KX-TE series PBX, and then start the Maintenance Console. For details about connecting a PC to a PBX or for details about the Maintenance Console, refer to the appropriate documentation.
2. In the Maintenance Console, save the PBX's system data file DSYS or xxxxxx.kea<sup>1</sup> to the PC.<sup>2</sup> For details about saving the system data file to the PC, refer to the appropriate documentation.
3. Start Web Maintenance Console for the KX-NS300 in Off-line mode.
4. In the Programme Launcher, click Database Converter.
5. In Select Original File Name, select the system file (DSYS or xxxxxx.kea<sup>1</sup>) you saved in step 2 as the file to convert.
6. Select WebMC Language and click "Next".
7. An image of converting the file to the KX-NS300 is displayed on the screen. The system data will be converted and a system data file for the KX-NS300 (DSYS) is created. It will complete within one minute.
8. After conversion is complete, you can click Save on the Result of Converting screen and save the results file to your PC.
9. In the "Select Next Step" screen, you can select the action from the followings.
  1. "Finish of Database Conversion"
  2. "Continue Online Programming (Connect - Online Mode)"
  3. "Continue Offline Programming (Open - Offline Mode)"

<sup>1</sup> The PBX's system data file

- KX-TDA100/KX-TDA200: DSYS
- KX-TE824: xxxxxx.kea

<sup>2</sup> The software version for KX-TDA100/KX-TDA200 and KX-TE824 series PBXs must meet the latest version requirements shown in the Data Converter tool. If the requirements are not met, you must use the Maintenance Console to upgrade the version to the latest version, and then save the DSYS or xxx.kea file.

**Notice**

- The following numbering plan settings are brought over during data conversion: Feature Numbers, Other PBX Number, Extension Number, Quick Dial Number
- PBX voice data (e.g., ESVM, SVM, OGM) is not converted.
- Data conversion for a SLC/LCOT card in the KX-NS300 is not supported; the number of ports in these cards is too small.
- In the case of KX-TDA100/KX-TDA200, data that is not supported by the data conversion is shown in the following table.

Unsupported Item	Default Setting
Time Mode	
Current time mode	Location setting default
Time mode switching time (manual mode)	Not Stored
Wired/Wireless extensions	
Timed Reminder	Not set
Station Lock	Unlocked
Remote Station Lock	Unlocked
Extension Call Charge Total	Total cleared
Not Ready/Ready (Wrap-up)	Wrap-up status cleared
LCS On/Off	Location setting default

### 5.3 Starting Web Maintenance Console

Unsupported Item		Default Setting
Room Status (Check In/Check out/Not Ready/Cleaned Up)		Location setting default
Auto Answer		Location setting default
Absent Message Status		Not set
Saved Number Redial		Number cleared
ICD Group Login Status (Login/Logout)		Location setting default
Message Waiting		Cancelled
Incoming Log		Cleared
Outgoing Log		Cleared
TAM Log		Cleared
Personal Absent Message		Message cleared
FWD/DND setting status (intercom/outside calls)		Setting Cancelled
Monitor PBX ID		Cleared
Trunk		
	Call Charge Total	Total cleared
	Traffic Data	Cleared
Incoming Call Group		
	Message Waiting	Cancelled
	Incoming Log	Cleared
	FWD/DND setting status (FWD/DND set or not)	Setting cancelled
	Traffic Data	Cleared
Verification Code Information		
	Verification Code Password, Lock Status	Unlocked
	Verification Code Password, Lock Counter	Counter cleared
	Call Charge Total	Total cleared
Cabinet Information		
	Incoming Log	Cleared
	Outgoing Log	Cleared



Unsupported Item		Default Setting
	Line Error Log	Cleared
	MPR-LPR Call Data Log	Cleared
System Information		
	Password, Lock Counter for Remote Programming	Counter cleared
	Major/Minor Error	Cleared
	Timed Reminder (Wake-up Call)	Cancelled

In the case of KX-TE824, data that is supported by the data conversion is shown in the following table.

Supported Item [xxx] : PT Programming Number	Converted Item [x.x.x] : PC Programming-System Menu Number
System Speed Dial/Name	
[001]System Speed Dialling Number	[6.1]System Speed Dial
[011]System Speed Dialling Name	[6.1]System Speed Dial
Extension data	
[009]Extension Number	[4.1.1]Extension Setting-Extension Number
[604]Extension Name	[4.1.1]Extension Setting-Extension Name
[601] TRS-COS-Day	[4.1.1]Extension Setting-COS
FWD/DND Setting(*)	[4.1.2]FWD/DND Setting
Flexible CO key (extension and DSS Console) (*)	[4.1.4]Flexible Button [4.3]DSS Console Flexible CO key (extension and DSS Console) The following data is not converted. – Saved Number Redial – Caller ID Indication Common/Personal – Caller ID Selection Common/Personal – LCS Cancel
PF Button	[4.1.5]PF Button
[012]Second Feature Numbering Plan	[2.6.2]Quick Dial-Phone Number
[310]Account Code	[6.3]Verification Code-Verification Code
Toll Restriction	

### 5.3 Starting Web Maintenance Console

Supported Item [xxx] : PT Programming Number	Converted Item [x.x.x] : PC Programming-System Menu Number
[302]TRS—COS 2 Denied Code	[7.1] Denied Code
[300]Carrier Exception Code	[8.5]Carrier - Carrier Access Code
[309]Emergency Number	[7.4]Emergency Dial

\*1 This setting is programmed by Personal Programming.

#### Note

Review the settings of feature numbers of converted data.  
Example: Idle Line Access (Local Access) settings

## KX-TVM System Prompt and Mailbox Data Import

Voice data recorded by users in a KX-TVM series VPS can be converted and used as voice data in the KX-NS300 Unified Messaging system. System prompts, mailbox prompts, and mailbox messages can be converted.

Condition:

- The required software versions are as follows:
  - KX-TVM series: version 1.0 or later

#### Notice

- Only data recorded by users can be imported; the preinstalled guidance data will not be imported.
  - The language set for the KX-TVM series VPS must be set as the language for the Unified Message system where the voice data will be imported. If the language is different, the data cannot be imported.
  - The following content of KX-TVM mailbox's audio data is not restored as the Unified Messaging system Mailbox data.
    - Receive message: Mailbox number of Recorder
    - Transfer message: Mailbox number of Recorder/Sender
    - Confirmation of hearing a message: Mailbox number of the responder  
In this case, the message is treated as if it were recorded by a non-subscriber.
    - Mailbox number of Recorder/Sender/Responder is not announced in restored audio data.
    - When IMAP integration is used, "Unknown Caller" is shown in the "From" field.
- Connect a PC to the KX-TVM series VPS, and then start the KX-TVM Maintenance Console.  
For details about connecting a PC to the VPS or about the Maintenance Console, refer to the appropriate documentation.
  - In Maintenance Console, back up the voice data on the KX-TVM series VPS to the PC.  
For details about backing up KX-TVM VPS voice data, refer to the documentation of the corresponding VPS.
  - Start the KX-NS300, and then start Web Maintenance Console.
  - Navigate to Maintenance → Tool → 10. UM data restore, and then select the types of voice data you want to restore (i.e., import). You can select the following types of data:
    - System prompts
      - For batch restore  
Under System Prompts, select the System Prompts check box.  
Condition:  
The Unified Messaging system has only 8 system prompts, which is less than the number on KX-TVM VPSs. If you restore system prompts, Prompt 9 and Prompt 10 on the KX-TVM VPS will not be restored. To import Prompt 9 and Prompt 10 to the Unified Messaging system, they must be restored individually.

- For individual restore  
You can select the voice data to restore one at a time as necessary.
    - Installed Prompts – Prompt1 to 8
    - Custom Service Menu
    - Company Name
    - Company Greeting
    - System Mailbox Group Voice Label
    - System Caller Name
    - Prompt Selection
    - Hold Announce Menu
  - b. Mailbox Prompts and Mailbox Messages
    - For batch restore  
Under Mailbox Prompts, select the Mailbox Prompts check box, and then select the Mailbox Messages check box.
    - For individual restore  
You can select the voice data to restore one at a time as necessary.
      - Owner Name
      - Personal Greetings
      - Personal Caller ID Name
      - Interview
      - Personal Group List Name
      - EMD List Member Name
      - Mailbox Messages
5. Select a file from **Local PC**, **USB Flash Drive (Main Unit)**, or **NAS** to restore, and the folder selection menu becomes active. Specify the folder where the backup data is saved, and then click **OK**. The selected voice data will be imported.

**Note**

- When using a NAS, ensure that you have sufficient network bandwidth.

6. The import results will be saved in a file called "UM\_data\_restore\_result.txt".

**Notice**

- It is possible that passwords are set on KX-TVM and Unified Messaging mailboxes. If the passwords for KX-TVM mailboxes are different from the Unified Messaging mailbox passwords, and data is being restored (imported) individually, you will be prompted for the password of the Unified Messaging mailbox. If password authentication fails 3 times, the voice data for that mailbox will not be imported.
- If you are not prompted for mailbox passwords during the restore, the password set for the mailbox in the Unified Messaging system will be used. If no passwords are set for Unified Messaging mailboxes (excluding the manager mailboxes), the default password specified in the Unified Messaging system will be applied. If the default password setting is disabled, the password "1111" will be applied. The default mailbox password will not be applied to the manager mailboxes.

### 5.3 Starting Web Maintenance Console

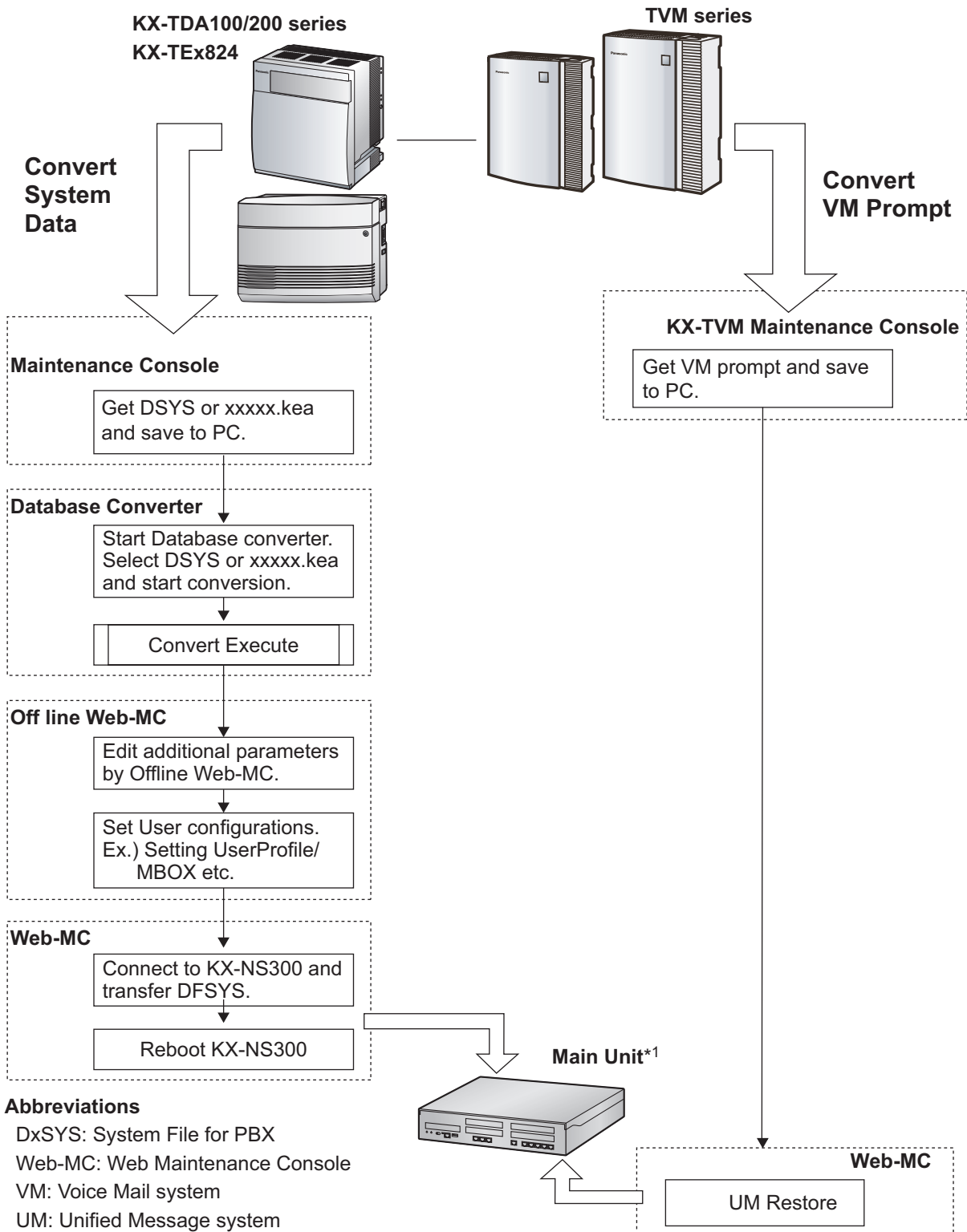

\*1 KX-NS300

## 5.4 Programming the PBX

### 5.4.1 Easy Setup Wizard

In the Easy Setup Wizard, you will set up the mandatory settings required for the PBX.

When you log in to Web Maintenance Console for a PBX that is in its initialised, factory default state, the Easy Setup Wizard for that PBX will launch automatically. You must log in using the Installer level account name and password.

- The Installer level account name is "INSTALLER".
  - The default Installer level account password is "1234".
1. After Easy Setup Wizard launches, the **Easy Setup Wizard** screen appears:
    - a. In **WebMC Language Setting**, select a language from the drop-down list.
    - b. In **Location Setting**, select a location from drop-down list.
    - c. In **Password Setting**, enter a password for the Installer level account. In **Re-enter**, enter the same password.
    - d. Click **Start Setup Wizard**.

#### **Note**

If the location is changed from its default value, a notice about restarting the PBX is displayed. Click **OK** to restart the PBX. After the PBX restarts, start Web Maintenance Console again (refer to "Connecting to Web Maintenance Console" in "5.3 Starting Web Maintenance Console"). When you start the Easy Setup Wizard again, you will start from step 1, below.

2. In the **Date & Time** Settings:
  - a. Select a time zone from the drop-down list.
  - b. Click the **Local Time** box, and then select the date and time from the menu.
  - c. In **Automatic Time Adjustment**, enter information as necessary.
  - d. In **Daylight Saving**, select the appropriate option.
  - e. Click **Next**.
3. In the **Numbering** settings:
  - a. In **Feature Number**, select the appropriate option.
  - b. In **CO Access/Operator Number**, select the appropriate options.
  - c. Select one of the following options for **Select the default value of numbering plan**:
    - 3 digits Extension Number
    - 4 digits Extension Number
  - d. Click **Next**.

#### **Note**

Depending on the value selected above, the numbering plan of the PBX will vary as follows. Select this value with care.

## 5.4.1 Easy Setup Wizard

	<b>3 digits Extension Number</b>	<b>4 digits Extension Number</b>
Extension Number	101–xxx or 201–xxx	1001–xxxx or 2001–xxxx
Floating Extension Number		
UM Group	500	5000
DISA (1–64)	501–564	5001–5064
Built-in Simplified Voice Message (SVM)	591	5091
Analogue Remote Maintenance	599	5099
TAFAS (Pager)	600	6000
ICD Group (1–64)	601–664	6001–6064
ISDN Remote Maintenance	699	6099
UM Channel (1–2)	592, 593	5092, 5093

4. In the **Manager/Operator** settings:
  - a. Select an extension number for the manager from the drop-down list.
  - b. Select an extension number for the operator from the drop-down list.
  - c. Click **Next**.
5. In the **Trunk** settings:
  - a. In **CO Dialing Mode**, select the appropriate option.
  - b. In **Selection for PRI30/E1**, select the appropriate option.
  - c. Select an option for **Incoming Call Distribution Group**. You can select "Yes" or "No". Refer to the information on this screen for details.
  - d. Click **Next**.
6. In the **LAN** settings:  
The IP addresses for the PBX, DNS server, and DSP card can be assigned automatically through a DHCP server or entered manually.

**When using a DHCP server:**

- a. Select **Obtain an IP address automatically**.
- b. Select **Obtain DNS server address automatically**.
- c. Select **Obtain DSP IP address automatically**.

**Notice**

The boxes will turn grey and the IP address information will be assigned automatically. Write down the address information assigned to the PBX for future reference.

- d. Click **Next**.

**When not using a DHCP server:**

- a. Select **Use the following IP address**.
- b. Enter an IP address<sup>1</sup>, subnet mask<sup>2</sup>, and default gateway<sup>1</sup>. (You may not need to specify the default gateway, depending on your network configuration.)
- c. Select **Use the following DNS server address**.

- d. Enter the preferred and alternative DNS IP addresses<sup>1</sup>.
- e. Select **Use the following DSP IP address**.
- f. Enter IP address<sup>1</sup> for installed DSP card.
- g. Click **Next**.

<sup>1</sup> Valid IP address range: "1.0.0.1" to "223.255.255.254"

<sup>2</sup> Valid subnet mask address range: "0-255.0-255.0-255.0-255" (except "0.0.0.0" and "255.255.255.255")

## 7. In the **VoIP (Ext)** settings:

In **Number of IP Extensions**:

- a. In **IP-PT(NT)**, specify the number of IP-PT extensions.
- b. In **UT/UDT**, specify the number of UT/UDT extensions.
- c. In **SIP-Phone**, specify the number of SIP extensions.

### **Note**

You can confirm the required number of virtual IP extension cards, total IP extensions and total virtual IP extension cards.

- d. In **IP Terminal Registration Mode**, select one of the following options:
  - **Manual**: Manually register IP terminal information.
  - **Full Automatic**: Automatically register IP terminal information.
  - **Extension Number Input**: Automatically register IP terminal information except the extension number. The extension number can then be registered from the IP telephone manually.

### **Note**

- The **Full Automatic** and **Extension Number Input** registration modes may not be available for certain types of IP terminals. In such cases, select **Manual** as the registration mode.
- For more information about the IP terminal registration modes, refer to "5.8.1 Registering IP Telephones".

- e. In **DHCP Server**, select either **Disable** or **Enable**.
- f. If you select **Enable** in **DHCP Server**, enter valid settings for the automatic assignment of IP addresses.
- g. Click **Finish**.

8. Follow the prompts of the Easy Setup Wizard. If LAN settings were changed from their default values in step 6, you will be prompted to restart the PBX after the Easy Setup Wizard is complete. Click **OK** to restart the PBX. The login screen will be displayed. Click **Skip** to finish the Easy Setup Wizard and continue the configuration from the home screen without restarting the PBX.

### **Notice**

If you select **Skip**, restart the PBX after completing the settings.

9. Log in with the Installer level account using the password entered during Easy Setup Wizard. The Home Screen is displayed. You may now begin programming the PBX.

### **Notice**

If an external DHCP server is in use, it must be able to use the "client identifier" option specified by RFC 213.

## Changing IP Address Settings

IP addressing information for the PBX can also be changed from Web Maintenance Console after the Easy Setup Wizard has been completed.

1. Click **Setup** → **Network Service** → **IP Address/Ports**.
2. Click the **Basic Settings** tab.
3. **When using a DHCP server:**
  - a. Select **Obtain an IP address automatically**.

- b. Select **Obtain DNS server address automatically**.
- c. Select **Obtain DSP IP address automatically**.

### **Notice**

The boxes will turn grey and the IP address information will be assigned automatically. Write down the address information assigned to the PBX for future reference.

### **When not using a DHCP server:**

- a. Select **Use the following IP address**.
  - b. Enter an IP address<sup>1</sup>, Subnet Mask<sup>2</sup>, and Default Gateway<sup>1</sup>.  
(The default gateway may not need to be specified depending on your network configuration.)
  - c. Select **Use the following DNS server address**.
  - d. Enter the preferred and alternative DNS IP addresses<sup>1</sup>.
  - e. Select **Use the following DSP IP address**.
  - f. Enter IP address<sup>1</sup> for installed DSP card.
4. Click **OK**.
    - a. A screen will appear stating that any changes made in step 3 will be activated after the PBX is restarted.
    - b. Click **OK**.
  5. Restart the PBX.
    - a. Click **Maintenance** → **System Control** → **System Reset**.
    - b. On the System Reset screen, click **Backup**.

<sup>1</sup> Valid IP address range: "1.0.0.0" to "223.255.255.255"

<sup>2</sup> Valid subnet mask address range: "0-255.0-255.0-255" (except "0.0.0.0" and "255.255.255.255")

### **Notice**

- Do not change the IP address of the PBX once IP telephones are registered to the PBX using the set IP address. The IP telephones will not operate properly if the IP address of the PBX is changed. When an external DHCP server is used to automatically assign IP addresses, it must be configured to always allocate the same IP address to the PBX. For details, consult your network administrator.
- If an external DHCP server is in use, it must be able to use a "client identifier" option specified by RFC 2131.
- If an external DHCP server is in use, the KX-NS300 DHCP Server feature must be disabled.
- The PBX will not start properly if IP addresses cannot be assigned automatically by the DHCP server when the PBX has been set to obtain IP addresses automatically. In this case, you need to consult your network administrator because the DHCP server in your network may not be running or a network failure may have occurred. If the DHCP server is not available, enter IP addresses manually, then restart the PBX.
- During a long programming session, it is highly recommended that you periodically save the system data to the PBX memory. If the PBX undergoes a sudden power failure or if the system is reset for some reason, all the system data in RAM will be lost. However, if system data has been saved to the PBX memory, it can be easily reloaded.  
To save the system data to the PBX memory while programming, click the disk button (  ) → **Yes** → **OK**. Be sure to save the system data to the PBX memory before restarting the PBX, or any changes may be lost.
- When no operations are performed for more than 60 minutes (default), you will be automatically logged out from Web Maintenance Console and unsaved data will be lost.

## Changing the Display Language

The language used for Web Maintenance Console can be changed after the Easy Setup Wizard has completed.

1. Click **Setup** → **Users** → **User Profiles**.
2. Select the check box for the Installer level account.



3. Click . The **Edit User** screen will be displayed.
4. Select the preferred language in **Change Language**.
5. Click **OK**. The screen will redisplay in the selected language immediately.

## 5.4.2 Enabling the DHCP Server Feature

This PBX is equipped with a DHCP Server feature. When the feature is enabled, it allows you to centrally manage and automate the assignment of IP addresses for the devices located in same LAN using Web Maintenance Console.

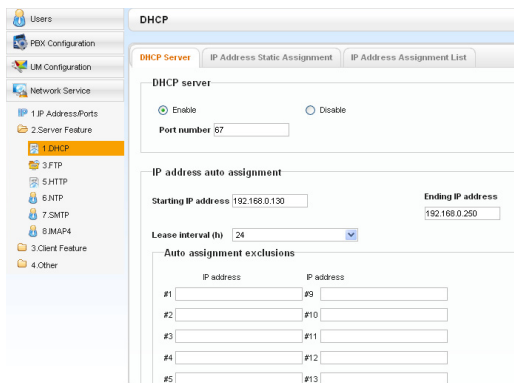

1. Click **Setup** → **Network Service** → **Server Feature** → **DHCP**.
2. On the **DHCP Server** tab, select **Enable** for **DHCP Server**.
3. Enter valid settings for the **IP address auto assignment**.

### Note

For details about **IP address auto assignment** settings, refer to "27.2.1 Network Service—[2-1] Server Feature—DHCP" in the PC Programming Manual.

4. Click **OK**.

### Note

If an external DHCP server is in use, do not enable the DHCP Server feature. Doing so may allocate inappropriate IP addressing information to the devices.

## 5.4.3 Installing the Virtual IP Cards to the PBX

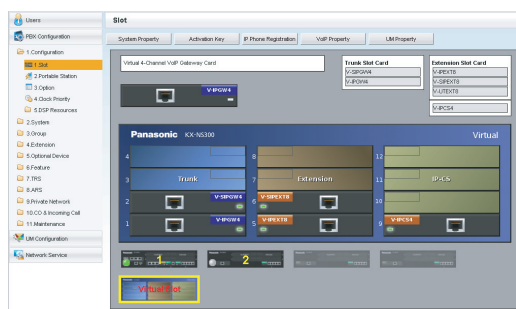

1. Click **Setup** → **PBX Configuration** → **Configuration** → **Slot**.
2. Place the mouse cursor over the **Virtual Slot**, and in the menu that appears, click **Select Shelf**.
3. Click on the name of the virtual card to install in the list on the right. An image of the virtual card will be displayed to the left of the list, and information about the card will be shown below.
4. Click and drag the image of the virtual card to the free virtual slot it is to be installed in, and release it. The virtual card will move into the slot space.
5. Click **OK** to confirm.

### 5.4.4 Installing Additional Activation Keys

The corresponding number of IP trunks, IP telephones or enhanced features can be activated by installing the downloaded activation key file(s) using Web Maintenance Console.

#### Installing the Activation Key Files

Be sure to connect the PC to the PBX in advance. For details about Web Maintenance Console, refer to "5.3 Starting Web Maintenance Console".

1. Log in to Web Maintenance Console using the Installer level account.
2. Click **Maintenance** → **Utility** → **Activation Key Installation**.  
**Activation Key Installation** window will be displayed.
3. Click **Browse** and specify the directory where the activation key files are stored, and click **Open**.
4. A list of activation key files stored in the specified directory is displayed. Check the boxes next to the activation keys to install to the PBX, and click **Install**.
5. When installation is complete, the message, "The activation key has been installed and activated successfully!" is displayed.
6. Click **OK**.

#### **Notice**

The activation key file can only be installed in the PBX with the MPR ID number entered when the activation key file was downloaded. The activation key file cannot be reissued unless the mother board crashes.

#### **Note**

- You can click the provided link to directly access activation key information and programme the number of activated IP trunks and IP softphones.
- For information about programming activation keys using Web Maintenance Console, refer to "9.3 PBX Configuration—[1-1] Configuration—Slot—Activation Key Status" in the PC Programming Manual.

### 5.4.5 Configuration of the Activation Keys

Depending on your configuration, it may be necessary to programme the number of provided IP Trunk channels to be used for H.323 trunks. By default, all of the provided IP Trunk channels will be used for SIP trunks. Similarly, you can programme how many IP softphone(s) can be used through the IP Softphone/IP Proprietary Telephone activation key. By default, only IP softphone(s) can be used through the IP Softphone/IP Proprietary Telephone activation key.

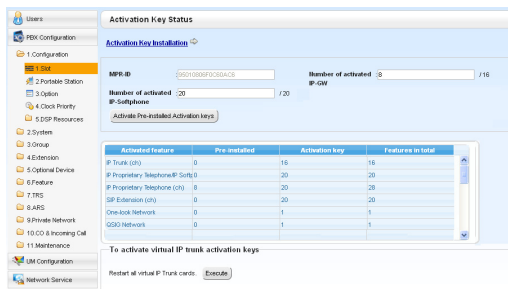

1.
  - a. Click **Setup** → **PBX Configuration** → **Configuration** → **Slot**.
  - b. Click **Activation Key**.
2.
  - a. In **Number of activated IP-GW**, type the number of IP Trunk channels to be used for H.323 trunks.

#### Note

If you have changed the value for **Number of activated IP-GW**, you must click **Execute** to restart the V-IPGW4 cards for the change to take effect.

- b. In **Number of activated IP-Softphone**, type the number of IP softphones to be used through the IP Softphone/IP Proprietary Telephone activation key.
3. Click **OK**.

## 5.5 Programming an H.323 QSIG Network

There are 2 methods to programme the Virtual 4-Channel VoIP Gateway Card (V-IPGW4 card) to establish VoIP communications between PBXs at different locations, as follows:

<b>PBX code method</b>	The caller dials the unique PBX code of the PBX to which the called party is connected, in addition to the destination number.
<b>Extension number method</b>	The caller dials only the destination number of the called party to call through PBXs at different locations (hence there are fewer digits to dial than with the PBX code method).

**Note**

- For a detailed explanation about each method, refer to "4.2 Private Network Features" in the Feature Guide.
- Portions of this software are © 1996–2006 RADVISION Ltd. All intellectual property rights in such portions of the Software and documentation are owned by RADVISION and are protected by United States copyright laws, other applicable copyright laws and international treaty provisions. RADVISION and its suppliers retain all rights not expressly granted.

### 5.5.1 Assigning the Hunt Pattern

The hunt pattern determines how to route incoming calls through virtual IP trunks to the PBX. The procedure below demonstrates the process of programming the hunt pattern of the local PBX. After the hunt pattern at the local PBX has been fully assigned, repeat the procedure for the hunt pattern at the remote PBX with the appropriate setting values.

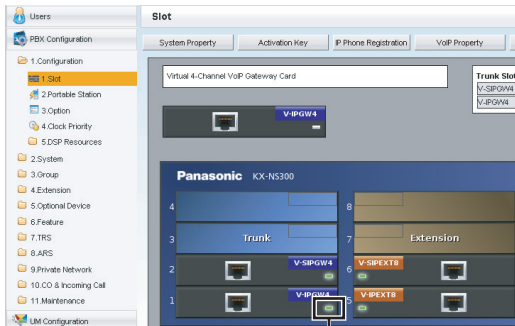

Status Light

- Click **Setup** → **PBX Configuration** → **Configuration** → **Slot**.
  - Place the mouse cursor over the **Virtual Slot**, and in the menu that appears, click **Select Shelf**.
  - Move the mouse pointer over the installed V-IPGW4 card. A menu will be shown under the mouse pointer.
  - Click **Shelf Property**.
  - Click **Hunt Pattern**.

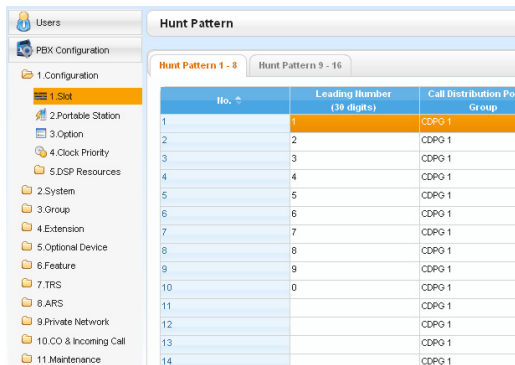

- When using the PBX code method:**  
In the **Leading Number** cell, type the local PBX code and extension starting digit.

**When using the extension number method:**  
In the **Leading Number** cell, type the local extension starting digit.

- Click **OK** to return to the Shelf Property screen.

**Note**

For more details about hunt pattern assignment, refer to "9.11.2 PBX Configuration—[1-1] Configuration—Slot—V-IPGW—Shelf Property—Hunt Pattern" in the PC Programming Manual.

## 5.5.2 Programming the Address Translation Table

The function of an address translation table in a VoIP network is to provide 2-way translation of telephone numbers and IP addresses<sup>\*1</sup>. Therefore, a caller can reach the destination by dialling the number without knowing the destination IP address.

The procedure below demonstrates the process of programming the address translation table at the local PBX. After the address translation table at the local PBX has been fully programmed, repeat the procedure for the address translation table at the remote PBX with the appropriate setting values.

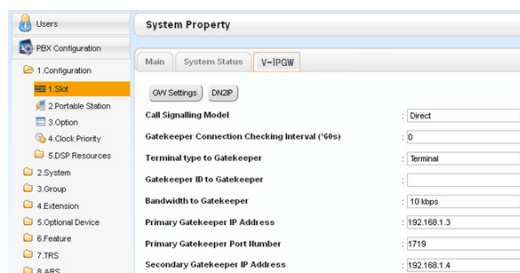

1.
  - a. Click **Setup** → **PBX Configuration** → **Configuration** → **Slot**.
  - b. Click **System Property**.
  - c. Click the **V-IPGW** tab.
  - d. Click **GW Settings**.

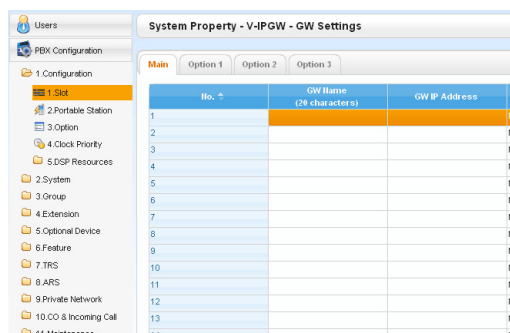

2. In the **Main** tab, do the following to configure the gateway entry for the remote PBX:
  - a. In the **GW Name** cell, type a unique identifier of the destination in the VoIP network.
  - b. In the **GW IP Address** cell, type the IP address of the destination gateway device.
  - c. In the **GW Group** cell, select **None**.

**Note**

Having the value **None** for **GW Group** means that the destination gateway device does not belong to any gateway group. Grouping is useful when installing multiple gateway devices at one location. For details, refer to "9.2.1 PBX Configuration—[1-1] Configuration—Slot—System Property—Main—V-IPGW—GW Settings—Main" in the PC Programming Manual.

- d. Click **OK** to return to the System Property screen.

\*1 IP address-to-telephone number translation can also be handled by using an H.323 Gatekeeper device. To configure Gatekeeper devices, refer to the manufacturer's documentation. This manual focuses on the method using the V-IPGW4 card's internal address translation capabilities.

## 5.5.2 Programming the Address Translation Table

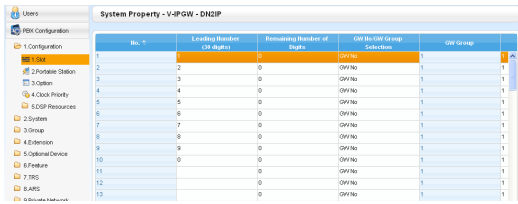

Slot	Leading Number (PBX digits)	Remaining Number of Digits	GW No./GW Group Selection	GW Group
2	2	0	GW No.	1
3	3	0	GW No.	1
4	4	0	GW No.	1
5	5	0	GW No.	1
6	6	0	GW No.	1
7	7	0	GW No.	1
8	8	0	GW No.	1
9	9	0	GW No.	1
10	0	0	GW No.	1
11	0	0	GW No.	1
12	0	0	GW No.	1
13	0	0	GW No.	1

3.
  - a. Click **Setup** → **PBX Configuration** → **Configuration** → **Slot**.
  - b. Click **System Property**.
  - c. Click the **V-IPGW** tab.
  - d. Click **DN2IP**.
  - e. **When using the PBX code method:**  
In the **Leading Number** cell, type the remote PBX code and starting digit of destination extension.  
  
**When using the extension number method:**  
In the **Leading Number** cell, type the remote PBX code and starting digit of destination extension.
  - f. In the **Remaining Number of Digits** cell, type a number of digits to dial following the leading number.
  - g. In **GW No./GW Group Selection**, select **GW No.**
  - h. In the **GW No.** cell, select **1** (the gateway entry for the destination gateway device at the remote PBX).
  - i. Click **OK**.

### Note

For more details about gateway settings, refer to "9.2.1 PBX Configuration—[1-1] Configuration—Slot—System Property—Main—V-IPGW—GW Settings—Main" in the PC Programming Manual.

## 5.5.3 Programming the Network Settings

For successful operation of a VoIP network using the V-IPGW4 card, network settings for the PBX at each location must be programmed appropriately. For a detailed discussion of related features, refer to the Feature Guide.

This section details the procedure to programme the network settings for the local PBX. After the programming for the local PBX has been done, repeat the procedure for the remote PBX with the appropriate setting values. The following procedures describe the process of programming the network settings for each numbering method.

### Programming for the PBX Code Method

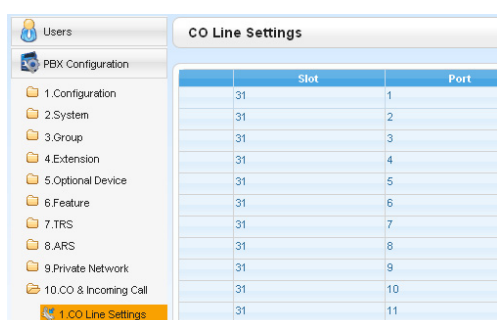

1.
  - a. Click **Setup** → **PBX Configuration** → **CO & Incoming Call**.
  - b. Click **CO Line Settings**.
  - c. Type the **CO Name** and assign an unused **Trunk Group Number** to be used for all IP trunks.
  - d. Click **OK**.

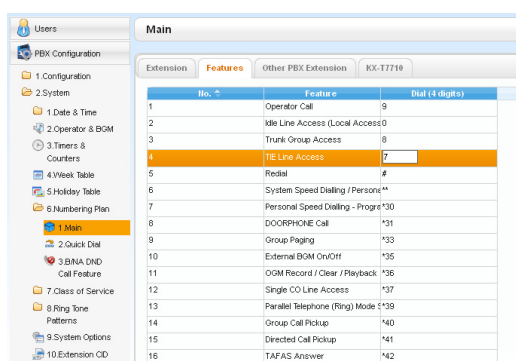

#### 2. Note

Before changing Numbering Plan settings, when a V-SIPEXT8 card or V-UTEXT8 card is installed, change the status of the card(s) to OUS.

- a. Click **Setup** → **PBX Configuration** → **System**.
  - b. Click **Numbering Plan**.
  - c. Click **Main**.
  - d. Click the **Features** tab.
  - e. In the **TIE Line Access** cell, type the dialling number.
  - f. Click **OK**.
3.
    - a. Click **Setup** → **PBX Configuration** → **Private Network**.
    - b. Click **TIE Table**.
    - c. In the **Own PBX Code** cell, type the PBX code of the local PBX in the network.
    - d. In the first unused **Leading Number** cell, type the PBX code of the remote PBX in the network.
    - e. In the corresponding **Trunk Group** list, select the number of the trunk group to be used when making calls.
    - f. If it is necessary to add number(s) to the input number, enter the number(s) to be added in the desired **Added Number** cell.
    - g. If it is necessary to delete number(s) from the input number, enter the number(s) to be deleted in the desired **Removed Number of Digits** cell.
    - g. Click **OK**.

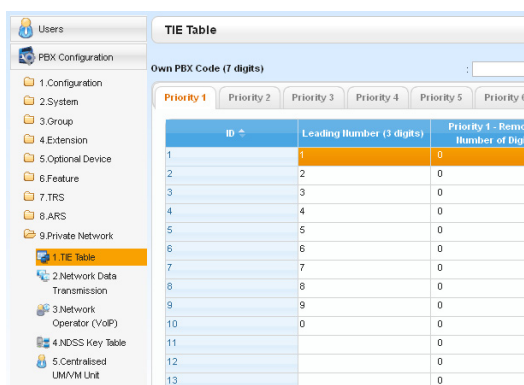

### 5.5.3 Programming the Network Settings

## Programming for the Extension Number Method

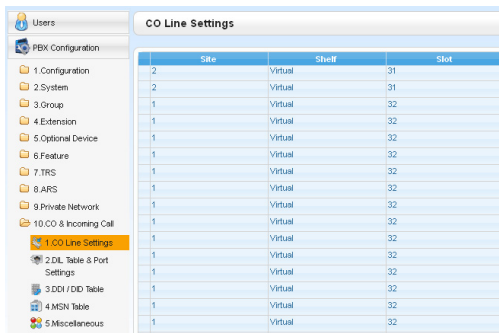

1.
  - a. Click **Setup** → **PBX Configuration** → **CO & Incoming Call**.
  - b. Click **CO Line Settings**.
  - c. Type the **CO Name** and assign an unused **Trunk Group Number** to be used for all IP trunks.
  - d. Click **OK**.

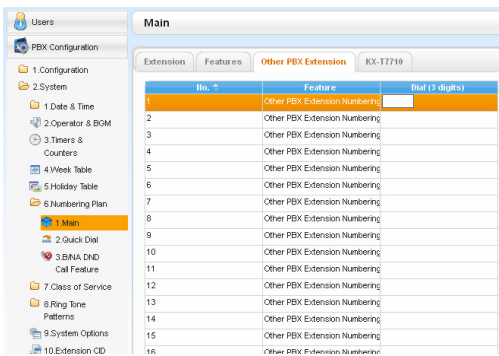

2. **Note**  
 Before changing Numbering Plan settings, when a V-SIPEXT8 card or V-UTEXT8 card is installed, change the status of the card(s) to OUS.
  - a. Click **Setup** → **PBX Configuration** → **System**.
  - b. Click **Numbering Plan**.
  - c. Click **Main**.
  - d. Click the **Other PBX Extension** tab.
  - e. In the **Dial (3 digits)** cell, type a starting digit of destination extension.
  - f. Click **OK**.

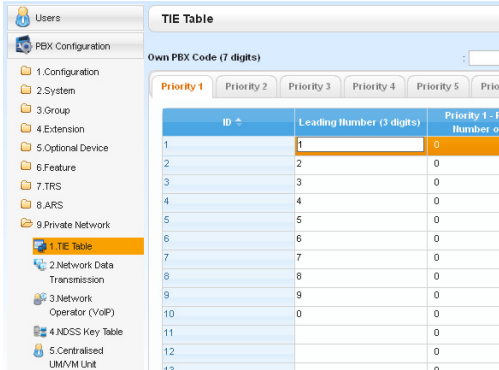

3.
  - a. Click **Setup** → **PBX Configuration** → **Private Network**.
  - b. Click **TIE Table**.
  - c. In the **Leading Number** cell, type the starting digit of destination extension.
  - d. Click **OK**.

**Note**

For details about network parameter settings, refer to the relevant sections of the PC Programming Manual.



## 5.6 Programming SIP Trunks

The Virtual 4-Channel SIP Trunk Card (V-SIPGW4) is a virtual trunk card which is designed to be easily integrated into an Internet Telephony Service provided by an ITSP (Internet Telephony Service Provider). Various settings can be programmed for each virtual SIP gateway port.

### Accessing Port Properties



1. Click **Setup** → **PBX Configuration** → **Configuration** → **Slot**.
2. Place the mouse cursor over the **Virtual Slot**, and in the menu that appears, click **Select Shelf**.
3. Move the mouse pointer over the V-SIPGW4 card to display the menu of options, and then click **Ous**.
4. Move the mouse pointer over the V-SIPGW4 card to display the menu of options again, and then click **Port Property**.

### Programming Port Properties

#### Automatic Programming

Some of the parameters can be automatically programmed by selecting the desired SIP provider for each virtual SIP gateway port. Available SIP providers can be selected, and a different SIP provider can be assigned to each virtual SIP gateway port.

#### Note

It is necessary to import a SIP provider list file (comma-separated value [CSV] file) in advance to use the automatic programming feature.

Follow the steps below to configure a SIP provider.

1. Click **Select Provider**.  
A dialogue box will appear. Available virtual SIP gateway port numbers are displayed in the list.
2. From the **Provider** menu, select the desired SIP provider.

#### Note

If the desired SIP provider is not shown in the drop-down list, it is necessary to programme the desired parameters manually. For information about the manual programming procedure, refer to "Manual Programming" below.

3. Highlight the desired port numbers or click **Select All** to select all the virtual SIP gateway port numbers to be assigned to the SIP provider selected in step 2.
4. Click **Execute**.  
Appropriate setting values designated by the SIP provider will be set in the parameters for the virtual SIP gateway ports.

### Manual Programming

Follow the steps below to programme the parameters which are not automatically programmed by selecting a provider.

1. Click the desired tab.
2. Enter information or select settings from the drop-down list for each parameter.

### Parameters that Require Manual Programming

Manual programming is compulsory for the following parameters:

- **User Name:** Specifies the user name (SIP Account) provided by the SIP provider. (Max. 64 characters)
- **Authentication ID:** Specifies the authentication ID required for registration with the SIP server. (Max. 64 characters)
- **Authentication Password:** Specifies the authentication password used for registration with the SIP provider. (Max. 32 characters)

Follow the steps below to programme these 3 parameters.

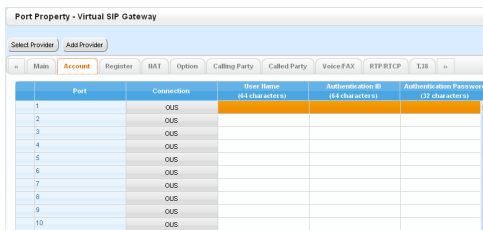

1. Click an **Account** tab.
2. In the **User Name** column, enter the user name provided by the SIP provider.
3. In the **Authentication ID** column, enter the authentication ID required for registration with the SIP server.
4. In the **Authentication Password** column, the authentication password used for registration with the SIP provider.
5. Click **OK**.

### Adding Settings to Provider Profiles

Follow the steps below to add the settings to provider profiles.

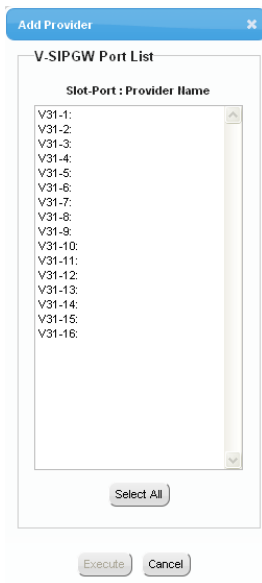

1. Click **Add Provider**.  
A dialogue box will appear. Available virtual SIP gateway port numbers are displayed in the list.
2. Highlight the desired port numbers or click **Select All** to select all the virtual SIP gateway port numbers to add the settings to provider profiles.
3. Click **Execute**.

### Note

For more details about SIP gateway port settings, refer to the PC Programming Manual.

## 5.7 Assigning Networking Information to IP Telephones

### 5.7.1 Assigning IP Addressing Information

The IP telephone's IP address, subnet mask address and default gateway address, and the PBX's IP address must be assigned to the IP telephone before it can be used on the network. This IP addressing information can be assigned in the following ways:

#### For IP-PTs

- **Using a DHCP server (DHCP Server feature or an external DHCP server) when the IP-PT is on the same LAN as the PBX**

The DHCP server automatically assigns the IP address of the IP-PT, the subnet mask address, and the default gateway address to the IP-PT.

The PBX's IP address can also be assigned automatically to the IP-PT in the process of being registered to the PBX. For details about registering the IP-PT, refer to "5.8.1 Registering IP Telephones".

#### **Note**

For information about the DHCP Server feature, refer to "8.1.2 DHCP (Dynamic Host Configuration Protocol) Server".

- **Using a DHCP server (DHCP Server feature or an external DHCP server) when the IP-PT is on a remote office LAN**

While the DHCP server automatically assigns the IP address of the IP-PT, the subnet mask address, and the default gateway address to the IP-PT, the PBX's IP address must be assigned manually.

Follow the procedure below to assign the PBX's IP address.

If you need to set VLAN parameters, follow the procedure described in "5.7.2 Setting VLAN Parameters" after assigning the IP addresses, without ending programming.

#### **Note**

- By assigning the PBX's IP address to one IP-PT, it is possible to assign the PBX's IP address to other IP-PTs or IP-CSs on the same LAN through system programming. For details, refer to "9.14 PBX Configuration—[1-1] Configuration—Slot—V-IPEXT—Port Property—Option—◆ Announce Mode" in the PC Programming Manual.
- IP-PTs can only receive IP addressing information from a DHCP server on its own LAN. Therefore, when IP-PTs are located on several LANs, a DHCP server is required on each LAN.
- Since the default setting of the DHCP client function is enabled for IP-PTs, simply connect the IP-PTs to the LAN to use the DHCP server.
- **For KX-NT511 Users**  
Since there is no PROGRAM button on a KX-NT511, press flexible button 1, 2, or 3 instead. Also, there is no Navigator key either. To select items on the LCD, use flexible button 1 for left-arrow operation and flexible button 3 for right-arrow operation.

## 5.7.1 Assigning IP Addressing Information

### KX-NT300 series (except KX-NT321) and KX-NT500 series (except KX-NT511 and KX-NT551)

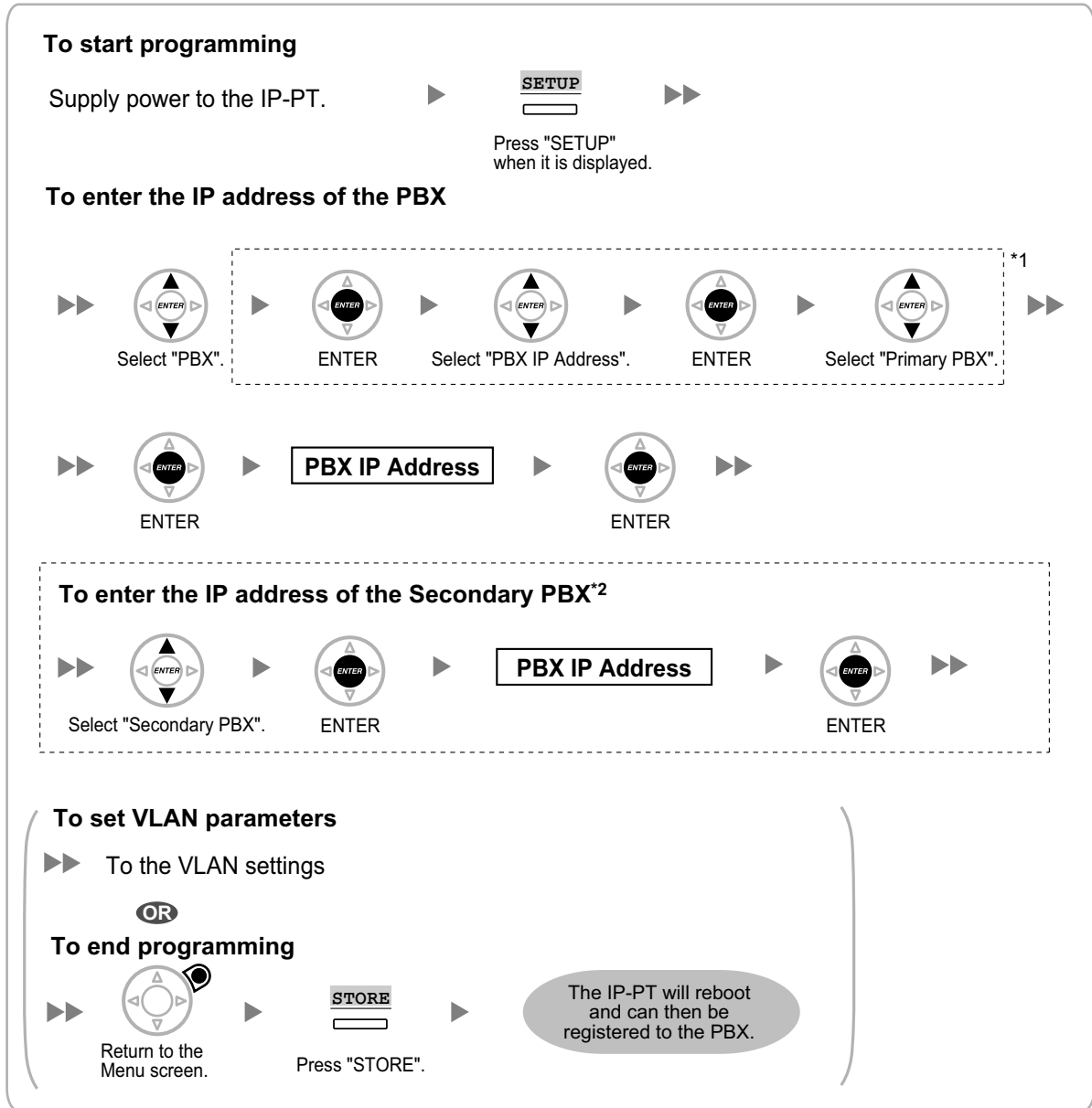

<sup>1</sup> For KX-NT300 series: Software version 2.00 or later only

For KX-NT500 series: Software version 1.00 or later only

<sup>2</sup> Optional for KX-NT300 series (Software version 2.00 or later only) and KX-NT500 series (Software version 1.00 or later only)

#### **Note**

The illustrations may differ from the buttons on your telephone.

**KX-NT321/KX-NT511/KX-NT551**

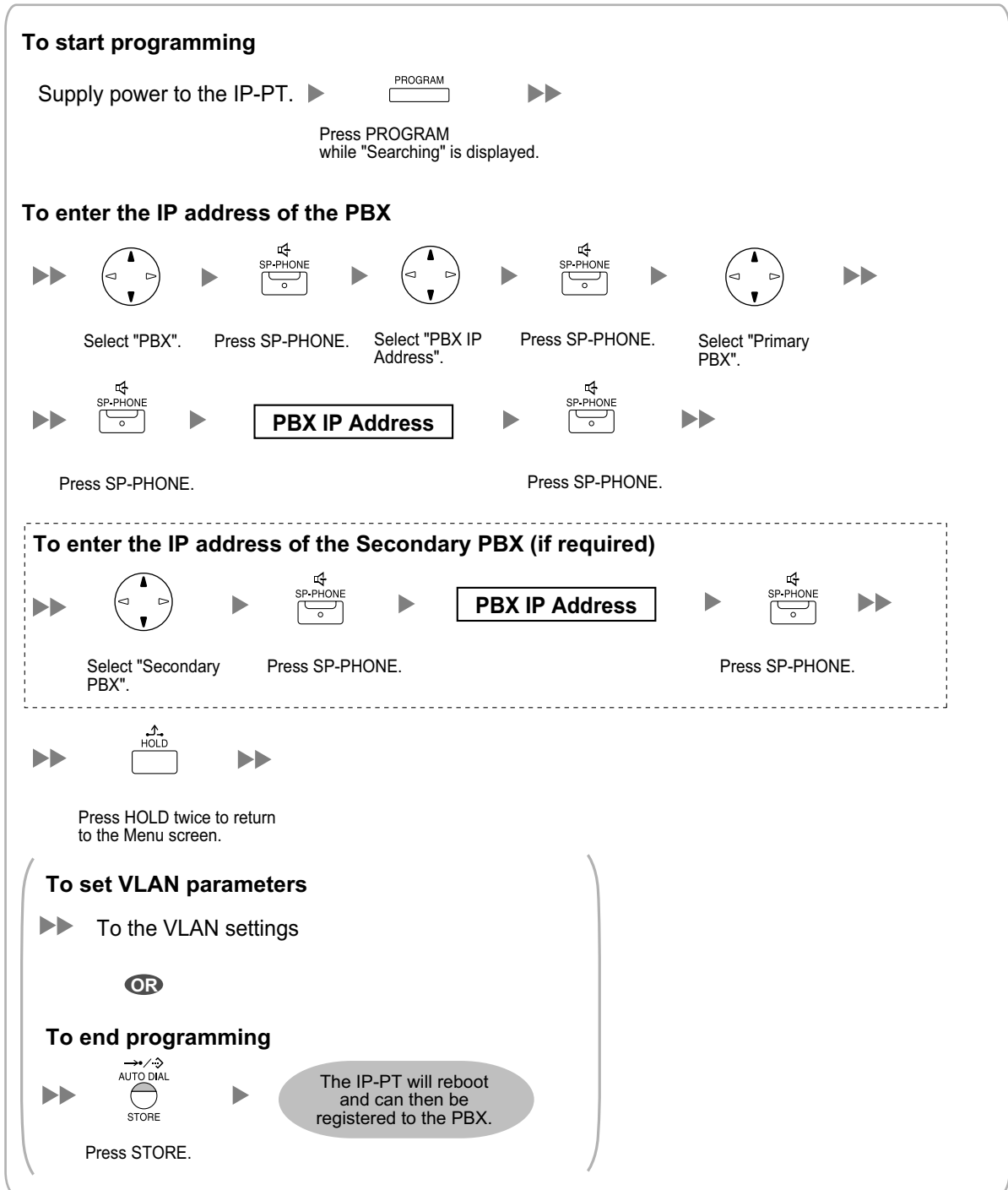

**Note**

- **For KX-NT511 Users**  
For details about operating the PROGRAM button and other buttons, refer to "For IP-PTs" in "5.7.1 Assigning IP Addressing Information".
- To confirm the connection to the secondary PBX after assigning IP addressing information, (1) turn the IP-PT's power off, and (2) hold the STORE button and 2 key while turning the power on.

**KX-NT265 (Software version 2.00 or later only)**

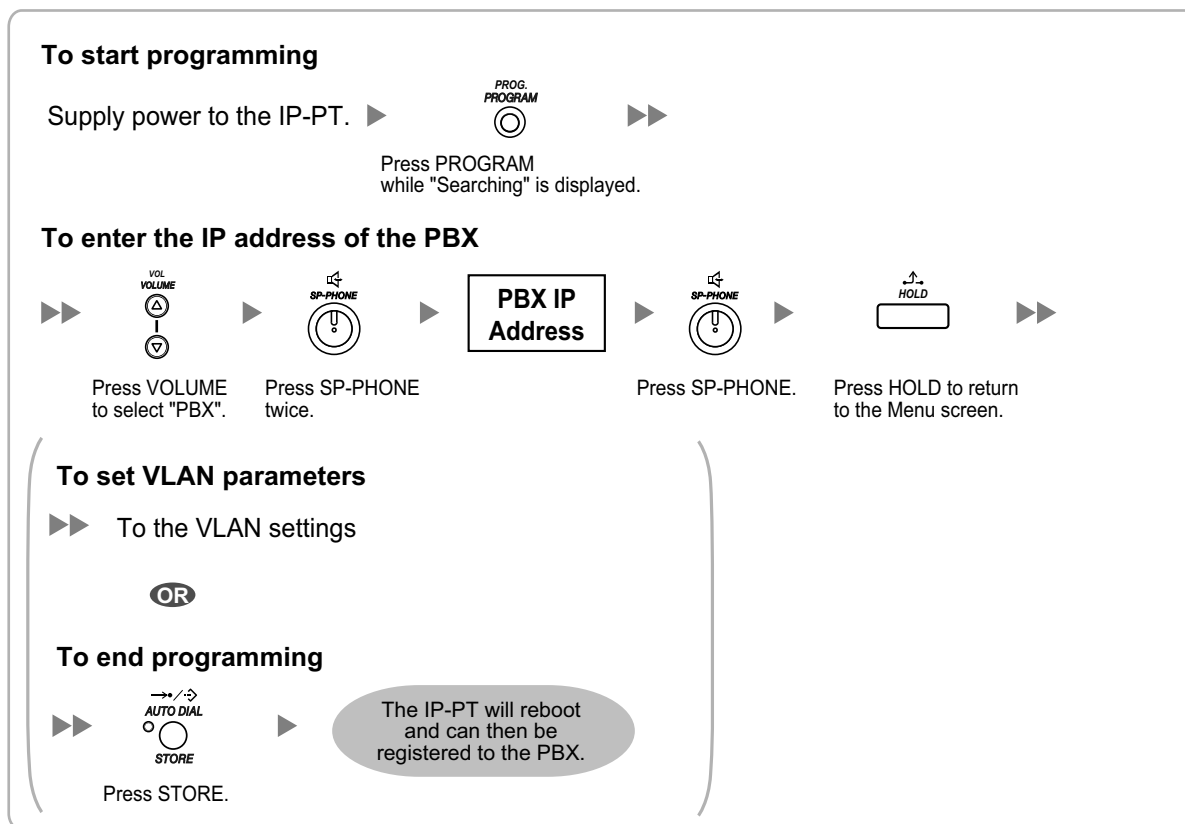

- **Not using a DHCP server (DHCP Server feature or an external DHCP server) when the IP-PT is on the same LAN as the PBX**

Only the PBX's IP address can be assigned automatically to the IP-PT in the process of being registered to the PBX. For details about registering the IP-PT, refer to "5.8.1 Registering IP Telephones".

Follow the procedure below to assign the IP address of the IP-PT, the subnet mask address, and the default gateway address manually.

If you need to set VLAN parameters, follow the procedure described in "5.7.2 Setting VLAN Parameters" after assigning the IP addresses, without ending programming.

#### KX-NT300 series (except KX-NT321) and KX-NT500 series (except KX-NT511 and KX-NT551)

##### To start programming

Supply power to the IP-PT.

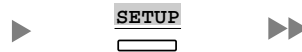

Press "SETUP" when it is displayed.

##### To set the IP address of the IP-PT

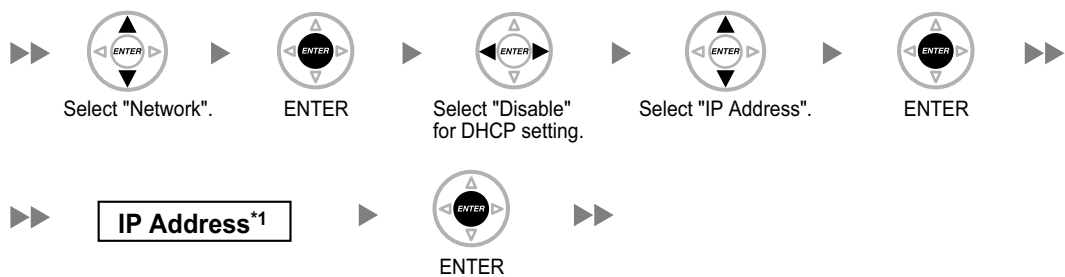

##### To set the subnet mask address

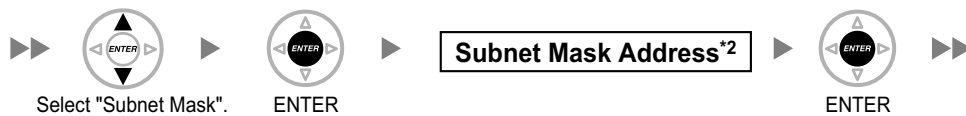

##### To set the default gateway address (if required)

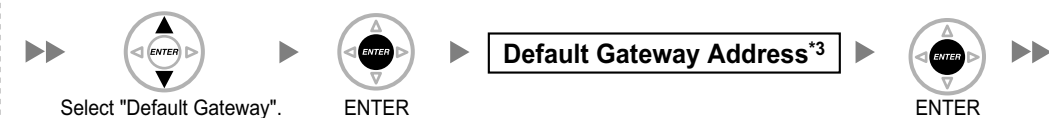

##### To enter the IP address of the Secondary PBX\*4

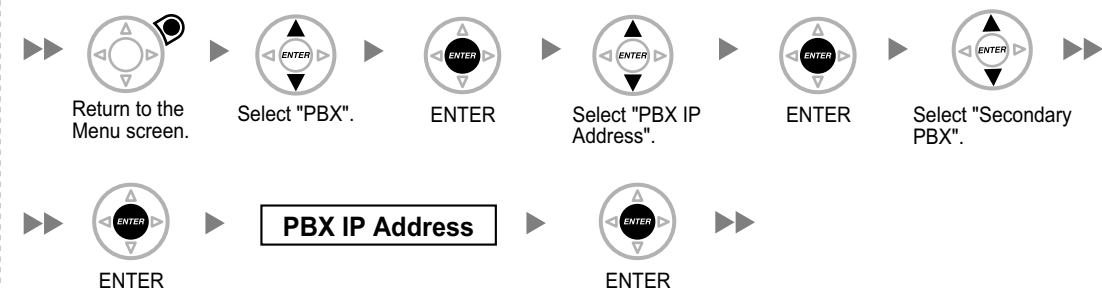

▶▶ Continued on next page

## 5.7.1 Assigning IP Addressing Information

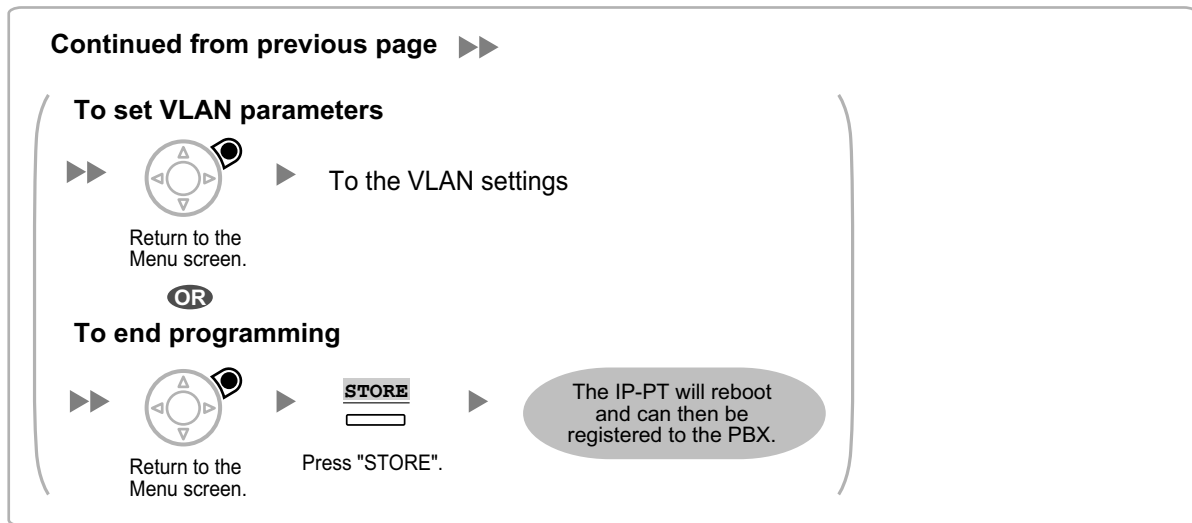

\*1 Valid IP address range: "1.0.0.0" to "223.255.255.255"

\*2 Valid subnet mask address range: "0-255.0-255.0-255.0-255" (except "0.0.0.0" and "255.255.255.255")

\*3 Valid IP address range: "1.0.0.0" to "223.255.255.255"

\*4 Optional for KX-NT300 series (Software version 2.00 or later only) and KX-NT500 series (Software version 1.00 or later only)



### **Note**

The illustrations may differ from the buttons on your telephone.

















KX-NT321/KX-NT511/KX-NT551

**To start programming**









Supply power to the IP-PT.    
 Press PROGRAM while "Searching" is displayed.

**To set the IP address of the IP-PT**



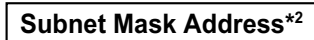





          
 Select "Network". Press SP-PHONE. Select "DHCP (Disable)". Press SP-PHONE twice.

      
 Press SP-PHONE.



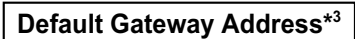









**To set the subnet mask address**







          
 Select "Subnet Mask". Press SP-PHONE. Press SP-PHONE.



**To set the default gateway address (if required)**

          
 Select "Default GW". Press SP-PHONE. Press SP-PHONE.

**To enter the IP address of the Secondary PBX (if required)**

              
 Press HOLD to return to the Menu screen. Select "PBX". Press SP-PHONE. Select "PBX IP Address". Press SP-PHONE. Select "Secondary PBX".

        
 Press SP-PHONE. Press SP-PHONE.

    
 Press HOLD twice to return to the Menu screen.

 **Continued on next page**

## 5.7.1 Assigning IP Addressing Information

---

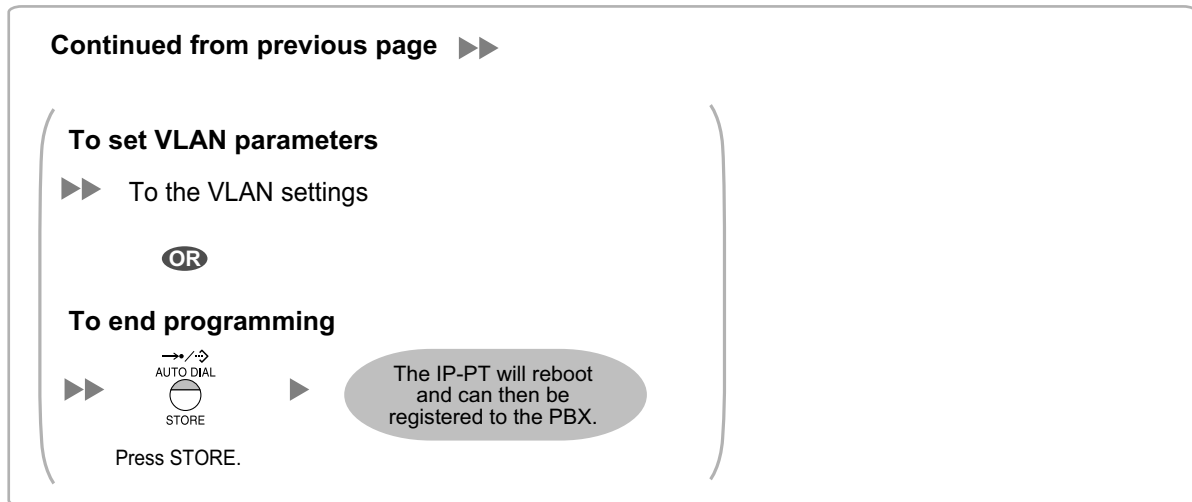

\*1 Valid IP address range: "1.0.0.0" to "223.255.255.255"

\*2 Valid subnet mask address range: "0-255.0-255.0-255.0-255" (except "0.0.0.0" and "255.255.255.255")

\*3 Valid IP address range: "1.0.0.0" to "223.255.255.255"

### Note

- **For KX-NT511 Users**  
For details about operating the PROGRAM button and other buttons, refer to "For IP-PTs" in "5.7.1 Assigning IP Addressing Information".
- To confirm the connection to the secondary PBX after assigning IP addressing information, (1) turn the IP-PT's power off, and (2) hold the STORE button and **2** key while turning the power on.

**KX-NT265 (Software version 2.00 or later only)**

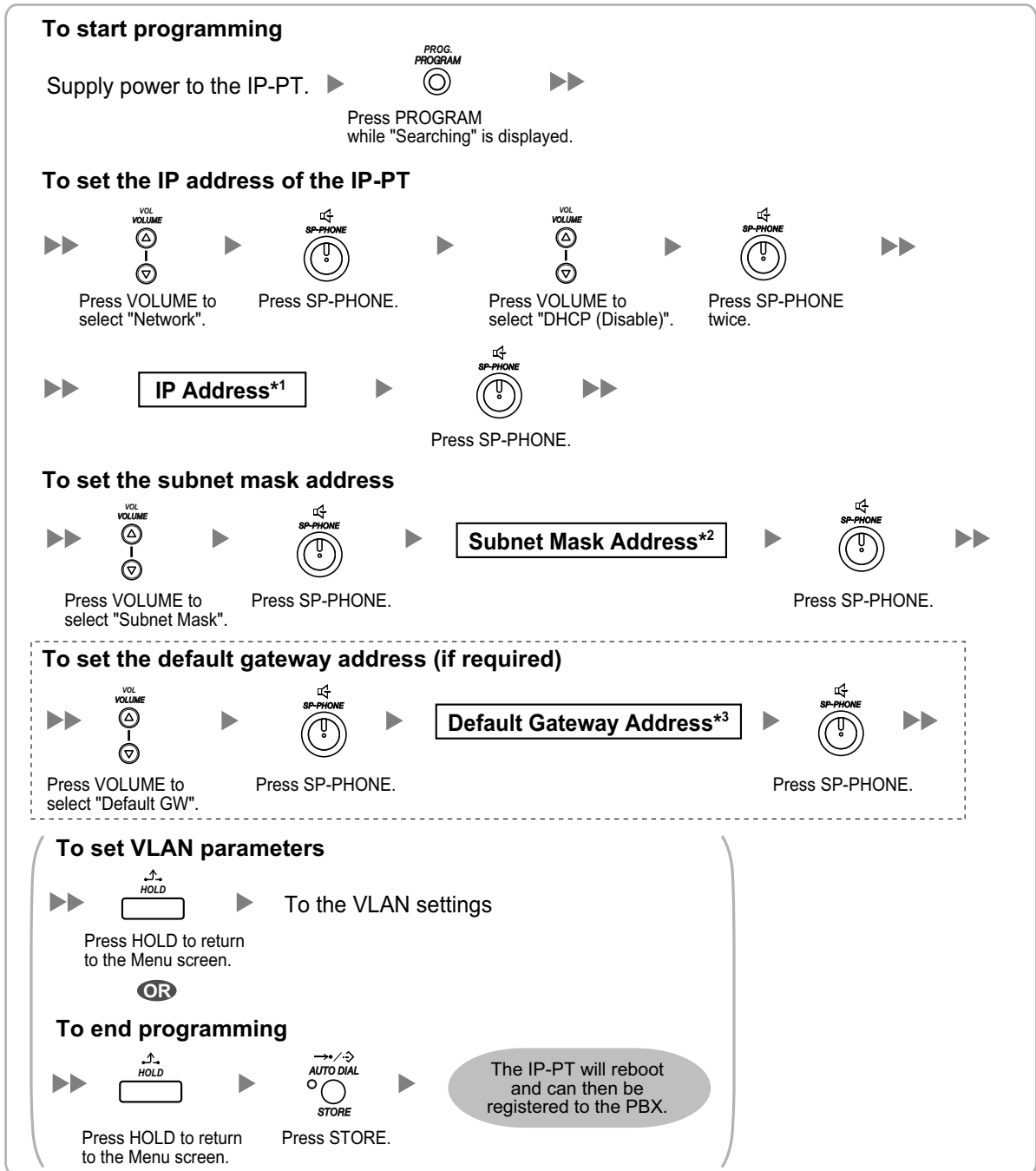

\*1 Valid IP address range: "1.0.0.0" to "223.255.255.255"

\*2 Valid subnet mask address range: "0-255.0-255.0-255.0-255" (except "0.0.0.0" and "255.255.255.255")

\*3 Valid IP address range: "1.0.0.0" to "223.255.255.255"

## 5.7.1 Assigning IP Addressing Information

---

- **Not using a DHCP server (DHCP Server feature or an external DHCP server) when the IP-PT is on a remote office LAN**

All of the IP addressing information must be assigned manually.

Follow the procedure below to assign the IP addressing information.

If you need to set VLAN parameters, follow the procedure described in "5.7.2 Setting VLAN Parameters" after assigning the IP addresses, without ending programming.

### **Note**

By assigning the PBX's IP address to one IP-PT, it is possible to assign the PBX's IP address to other IP-PTs or IP-CSs on the same LAN through system programming. For details, refer to "9.14 PBX Configuration—[1-1] Configuration—Slot—V-IPEXT—Port Property—Option—◆ Announce Mode" in the PC Programming Manual.

KX-NT300 series (except KX-NT321) and KX-NT500 series (except KX-NT511 and KX-NT551)

**To start programming**

Supply power to the IP-PT.

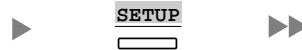

Press "SETUP" when it is displayed.

**To set the IP address of the IP-PT**

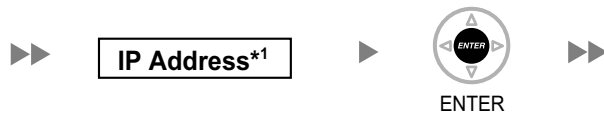

**To set the subnet mask address**

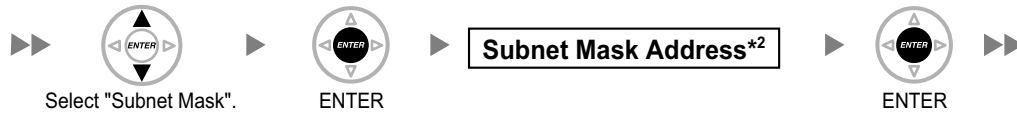

**To set the default gateway address**



**To enter the IP address of the PBX**

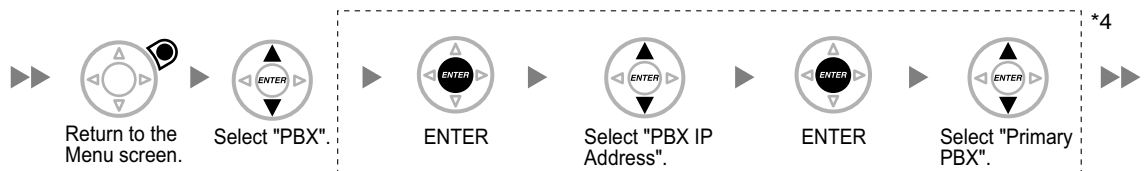

Continued on next page

## 5.7.1 Assigning IP Addressing Information

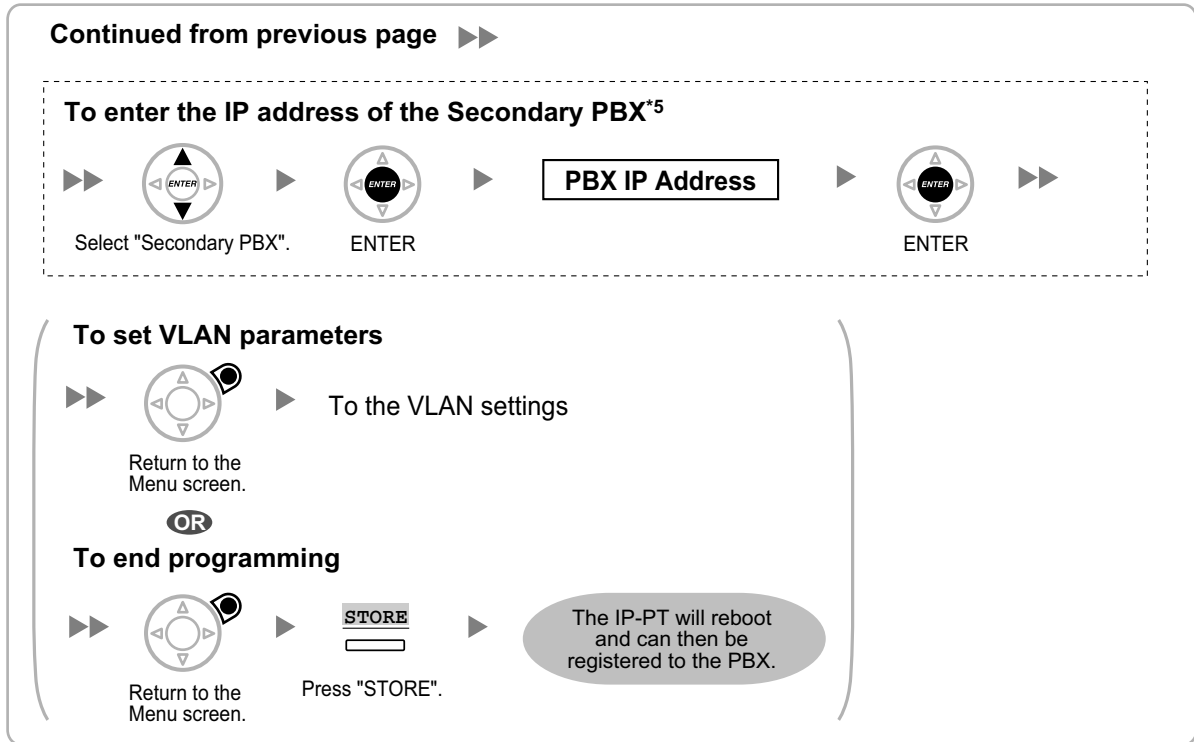

\*1 Valid IP address range: "1.0.0.0" to "223.255.255.255"

\*2 Valid subnet mask address range: "0-255.0-255.0-255.0-255" (except "0.0.0.0" and "255.255.255.255")

\*3 Valid IP address range: "1.0.0.0" to "223.255.255.255"

\*4 For KX-NT300 series: Software version 2.00 or later only

For KX-NT500 series: Software version 1.00 or later only



\*5 Optional for KX-NT300 series (Software version 2.00 or later only) and KX-NT500 series (Software version 1.00 or later only)

### **Note**









The illustrations may differ from the buttons on your telephone.

KX-NT321/KX-NT511/KX-NT551

**To start programming**









Supply power to the IP-PT.    
 Press PROGRAM while "Searching" is displayed.

**To set the IP address of the IP-PT**



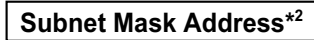





          
 Select "Network". Press SP-PHONE. Select "DHCP (Disable)". Press SP-PHONE twice.

      
 Press SP-PHONE.



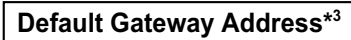

















**To set the subnet mask address**

          
 Select "Subnet Mask". Press SP-PHONE. Press SP-PHONE.

**To set the default gateway address**

          
 Select "Default GW". Press SP-PHONE. Press SP-PHONE.

**To enter the IP address of the PBX**

              
 Press HOLD to return to the Menu screen. Select "PBX". Press SP-PHONE. Select "PBX IP Address". Press SP-PHONE. Select "Primary PBX".  
        
 Press SP-PHONE. Press SP-PHONE.

**To enter the IP address of the Secondary PBX (if required)**

          
 Select "Secondary PBX". Press SP-PHONE. Press SP-PHONE.

 **Continued on next page**

## 5.7.1 Assigning IP Addressing Information

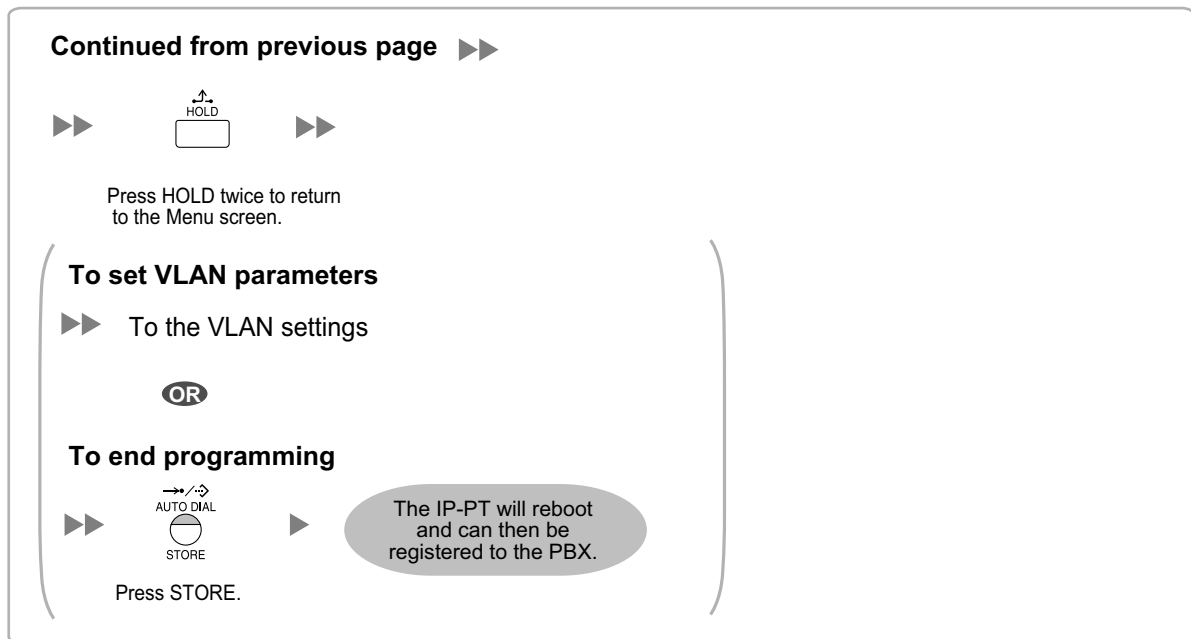

\*1 Valid IP address range: "1.0.0.0" to "223.255.255.255"

\*2 Valid subnet mask address range: "0-255.0-255.0-255.0-255" (except "0.0.0.0" and "255.255.255.255")

\*3 Valid IP address range: "1.0.0.0" to "223.255.255.255"

### Note

- **For KX-NT511 Users**

For details about operating the PROGRAM button and other buttons, refer to "For IP-PTs" in "5.7.1 Assigning IP Addressing Information".

- To confirm the connection to the secondary PBX after assigning IP addressing information, (1) turn the IP-PT's power off, and (2) hold the STORE button and **2** key while turning the power on.



**KX-NT265 (Software version 2.00 or later only)**

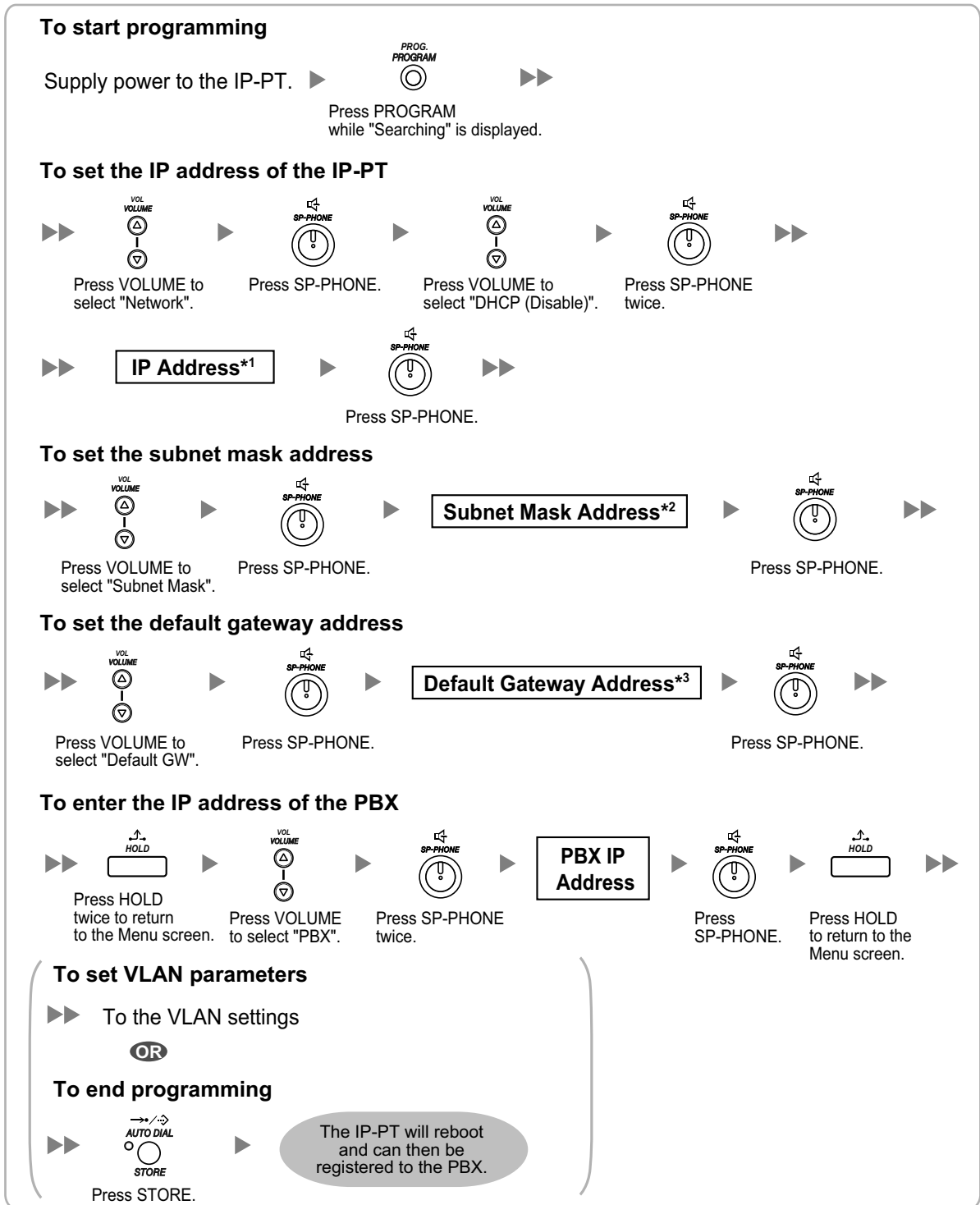

\*1 Valid IP address range: "1.0.0.0" to "223.255.255.255"

\*2 Valid subnet mask address range: "0-255.0-255.0-255.0-255" (except "0.0.0.0" and "255.255.255.255")

\*3 Valid IP address range: "1.0.0.0" to "223.255.255.255"

### For KX-UT Series SIP Phones

#### **Notice**

When you want to use a KX-UT series SIP phone that has already been used with another PBX, or that has had its settings programmed, you must reset the SIP phone to its factory default before assigning new IP address information as detailed in the following procedure.

For details, refer to the documentation for the KX-UT series SIP phone.

#### **Assigning the IP addressing information to the SIP phone**

- **Using a DHCP server (DHCP Server feature or an external DHCP server) to automate the assignment of IP addressing information**

The DHCP server automatically assigns the IP address of the SIP phone, the subnet mask address, and the default gateway address to the SIP phone.

The PBX's IP address can also be assigned automatically to the SIP phone in the process of being registered to the PBX. For details about registering the SIP phone, refer to "5.8.1 Registering IP Telephones".

#### **Note**

For information about the DHCP Server feature, refer to "8.1.2 DHCP (Dynamic Host Configuration Protocol) Server".

- **Not using a DHCP server (DHCP Server feature or an external DHCP server) when assigning IP addressing information**

Only the PBX's IP address can be assigned automatically to the SIP phone in the process of being registered to the PBX. For details about registering the SIP phone, refer to "5.8.1 Registering IP Telephones". The IP address of the SIP phone, the subnet mask address, and the default gateway address must be assigned manually. For instructions, refer to the documentation of the SIP phone.

#### **Note**

- When the PBX is not in the same network as the SIP phone, the IP address of the PBX must be assigned manually. For instructions for manually setting PBX network information, refer to "Assigning the IP address of the PBX to a SIP phone".
- When assigning IP addressing information to the SIP phone, do not use the phone's Web user interface programming.

#### **Assigning the IP address of the PBX to a SIP phone**

The IP address of the PBX is automatically assigned to a SIP phone when the SIP phone is in the same LAN as the PBX. However, when the SIP phone is in a different LAN from the PBX, the following procedure is required to assign the IP address of the PBX manually using the Web user interface.

#### **Notice**

Do not perform any other operation rather than following procedure with the Web user interface. Otherwise the SIP phone may not work properly. In that case, contact an authorised Panasonic Factory Service Centre.

1. Prepare a configuration file to specify the IP address of the PBX.

#### **When the SIP Phones are in a segment that uses NAT traversal**

- a. Open a text editor on a PC, and then write exactly same as the following:

**For standard connection**

```
# PCC Standard Format File # DO NOT CHANGE THIS LINE!

### Management Server Settings #####
ACS_URL="http://xxx.xxx.xxx.xxx:yyy/cwmp/cwmpAction.cgi"
```

**For secure connection**

```
# PCC Standard Format File # DO NOT CHANGE THIS LINE!
### Management Server Settings #####
ACS_URL="http://xxx.xxx.xxx.xxx:yyy/cwmp/cwmpAction.cgi"
CFG_INT_CERTIFICATE_PATH=http://xxx.xxx.xxx.xxx:zzz/utdownload/KX-NS300
```

**Notice**

- For "xxx.xxx.xxx.xxx:yyy", enter the IP address and port number of the network router which is in a same LAN with the PBX.  
The router accessed by the SIP phone must have static NAT/NAPT settings enabled so that the packets sent to xxx.xxx.xxx.xxx:yyy to be transferred to the PBX. For details, refer to "Connection via Internet" in "5.2 PC Connection" and "Internet Connection (SSL Connection):" in "5.3 Starting Web Maintenance Console".
- Configuration files must end with an empty line.

b. Save the text file as "UT\_ACS.cfg".

**When the SIP Phones are in a different segments of the same LAN**

- Log in to the Web Maintenance Console of the site where the SIP phones will be registered.
- Click **Utility** → **File** → **File Transfer PBX to PC**.
- Select the config file (UT\_ACS\_xxyyyy.cfg), and then download it to your PC.  
For more details about downloading files from a PBX to a PC, refer to "7.2.2 Utility—File—File Transfer PBX to PC" in the PC Programming Manual.

**Note**

xx: Site ID (2 digits)

yyyy: Site name<sup>1</sup> (Up to 32 characters<sup>2</sup>)

<sup>1</sup> Spaces as well as the following characters in site names will be replaced with underscores.  
/, :, \*, ?, ", <, >, | (vertical bar), &, +

<sup>2</sup> In some cases, the full site name may not be included in the file name even if it is less than 32 characters.

**When the SIP Phones are in a different LAN (Remote site installation)**

- Log in to the Web Maintenance Console of the site where the SIP phones will be registered.
- Click **Utility** → **File** → **File Transfer PBX to PC**.
- Select the config file (UT\_ACS\_HTTPS\_xxyyyy.cfg), and then download it to your PC.

**Note**

- xx: Site ID (2 digits)

- yyyy: Site name<sup>1</sup> (Up to 32 characters<sup>2</sup>)

<sup>1</sup> Spaces as well as the following characters in site names will be replaced with underscores.  
/, :, \*, ?, ", <, >, | (vertical bar), &, +

<sup>2</sup> In some cases, the full site name may not be included in the file name even if it is less than 32 characters.

- When SIP phones use the internet to communicate with the PBX, KX-NS300 uses the HTTPS protocol for security.

## 5.7.1 Assigning IP Addressing Information



---

2. Confirm the IP address of the SIP phone.  
For non-KX-UT670 telephones
  - a. Press **Setting** or **Setup** (soft button) on the SIP phone.
  - b. Select "**Information Display**", then press **[ENTER]**.
  - c. Select "**IP address**".  
The IP address of the SIP phone will be displayed.
  - d. Press **[CANCEL]**.For KX-UT670 telephones
  - a. Tap the status bar.  
For details about the status bar, refer to the documentation of the KX-UT670.
  - b. Tap Phone status.  
The IP address of the SIP phone will be displayed.
  - c. Tap OK.
3. Open the port of the SIP phone, which is used by the PCs to access the Web user interface.  
For non-KX-UT670 telephones
  - a. Press **Setting** or **Setup** (soft button) on the SIP phone.
  - b. Press **#[5][3][4]**.
  - c. Select "On" for "**Embedded web**", then press **[ENTER]**.

### **Note**

If no operation are made for 30 minutes, the port will be closed again automatically.

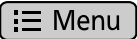
For KX-UT670 telephones

- a. On the Home screen, press  **Menu**.
- b. Tap Settings.
- c. Tap About Phone.
- d. Touch and hold  **Menu**.
- e. Press **#[5][3][4]**, and then press Enter.
- f. Select On for Embedded web.

### **Note**

If no operation are made for 30 minutes, the port will be closed again automatically.

4. Access the Web user interface from the PC.

### **Note**

If a KX-UT670 with software version 01.200 or lower is used with the KX-NS300, the KX-UT670 must be reset to its factory default before you perform the following procedure. For details about resetting the KX-UT670, refer to the documentation of the KX-UT670.

- a. Open your Web browser, and then enter "http://" followed by the SIP phone's IP address into the address field of your browser.
- b. For authentication, enter your ID and password, and then click **OK**.  
The Installer Level ID and Password are as follows.  
ID: instoperatoruserid  
Password: instpass
- c. Select **Maintenance** → **Import Configuration File**.
- d. Click **Browse...**, and then select the UT\_ACS configuration file. (UT\_ACS.cfg or UT\_ACS\_xxyyyy.cfg)
- e. Click **Import**.

When the configuration file is successfully imported, the SIP phone starts to access the PBX automatically.

**Panasonic**  
KX-UT123

Status Network System VoIP Telephone **Maintenance**

Web Port Close

**Import Configuration File**

**Import Configuration File**

Configuration File Type  Standard  Product  Master

Encryption  Yes  No

File Name

**Maintenance**

- Import Configuration File
- Export Configuration File
- Export Web Settings
- Firmware Maintenance
- Local Firmware Update
- Provisioning Maintenance
- Management Server
- Power Down Log
- Reset to Defaults
- Restart

5. Confirm if the configuration file was successfully loaded.
  - a. Select **Maintenance** → **Export Configuration File**.
  - b. Click **Export** to download the configuration file being used currently on the SIP phone.

**Panasonic**  
KX-UT123

Status Network System VoIP Telephone **Maintenance**

Web Port Close

**Export Configuration File**

**Export Configuration File**

Configuration File Type  Standard  Product  Master

**Maintenance**

- Import Configuration File
- Export Configuration File
- Export Web Settings
- Firmware Maintenance
- Local Firmware Update
- Provisioning Maintenance
- Management Server
- Power Down Log
- Reset to Defaults
- Restart

- c. Compare the UT\_ACS configuration file and the downloaded file. If the UT\_ACS configuration file was successfully loaded, the contents of those 2 files will be exactly the same.

#### **Notice**

When the 2 UT\_ACS configuration files do not match, and if the SIP phone does not work properly, contact an authorised Panasonic Factory Service Centre.

## For Non-KX-UT Series SIP Phones

**Using a DHCP server (DHCP Server feature or an external DHCP server) to automate the assignment of IP addressing information**

The IP address of the SIP phone, the subnet mask address, and the default gateway address can be assigned to the SIP phone automatically by the DHCP server.

The PBX's IP address must be assigned manually on the SIP phone side.

### 5.7.1 Assigning IP Addressing Information

---

For instructions, refer to the documentation of the SIP phone.

#### **Not using a DHCP server (DHCP Server feature or an external DHCP server) when assigning IP addressing information**

All of the IP addressing information must be assigned manually.

For instructions, refer to the documentation of the SIP phone.

#### **Note**

- A SIP phone can only receive IP addressing information from a DHCP server on its own LAN. Therefore, when SIP phones are located on several LANs, a DHCP server is required on each LAN.
- When the DHCP client function is enabled for SIP phones, simply connect them to the LAN to use the DHCP server. For details about the DHCP client function setting, refer to the documentation of the SIP phone.

## 5.7.2 Setting VLAN Parameters

To establish voice communications between IP telephones, the primary ports of the IP telephones and the connected PBX must belong to the same VLAN. Consult your network administrator and obtain the appropriate VLAN ID.

If you are using an IP telephone equipped with two ports, it is possible to place primary and secondary ports of the IP telephone on different VLANs by assigning separate VLAN IDs to each port.

Follow the procedure below for all IP-PTs on the network, using appropriate VLAN IDs.

### Note

The procedure for SIP phones may vary depending on the type of the SIP phone being used. Refer to the documentation of your SIP phone for instructions.

### KX-NT300 series (except KX-NT321) and KX-NT500 series (except KX-NT511 and KX-NT551)

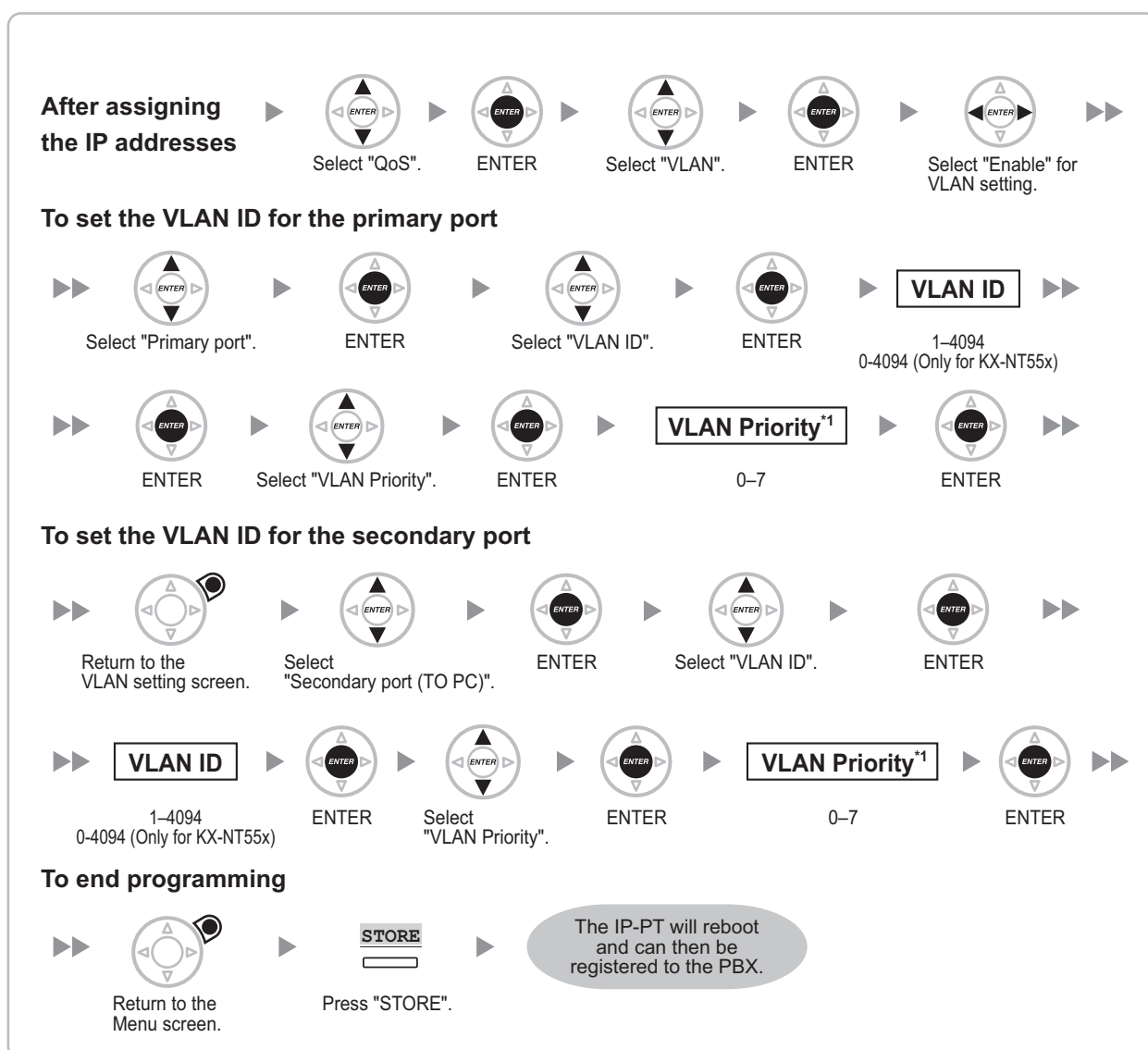

<sup>\*1</sup> The VLAN priority of the primary port must be set higher than the priority of the secondary port. The larger the number, the higher the priority.

## 5.7.2 Setting VLAN Parameters

### Note

The illustrations may differ from the buttons on your telephone.

### KX-NT321/KX-NT511/KX-NT551

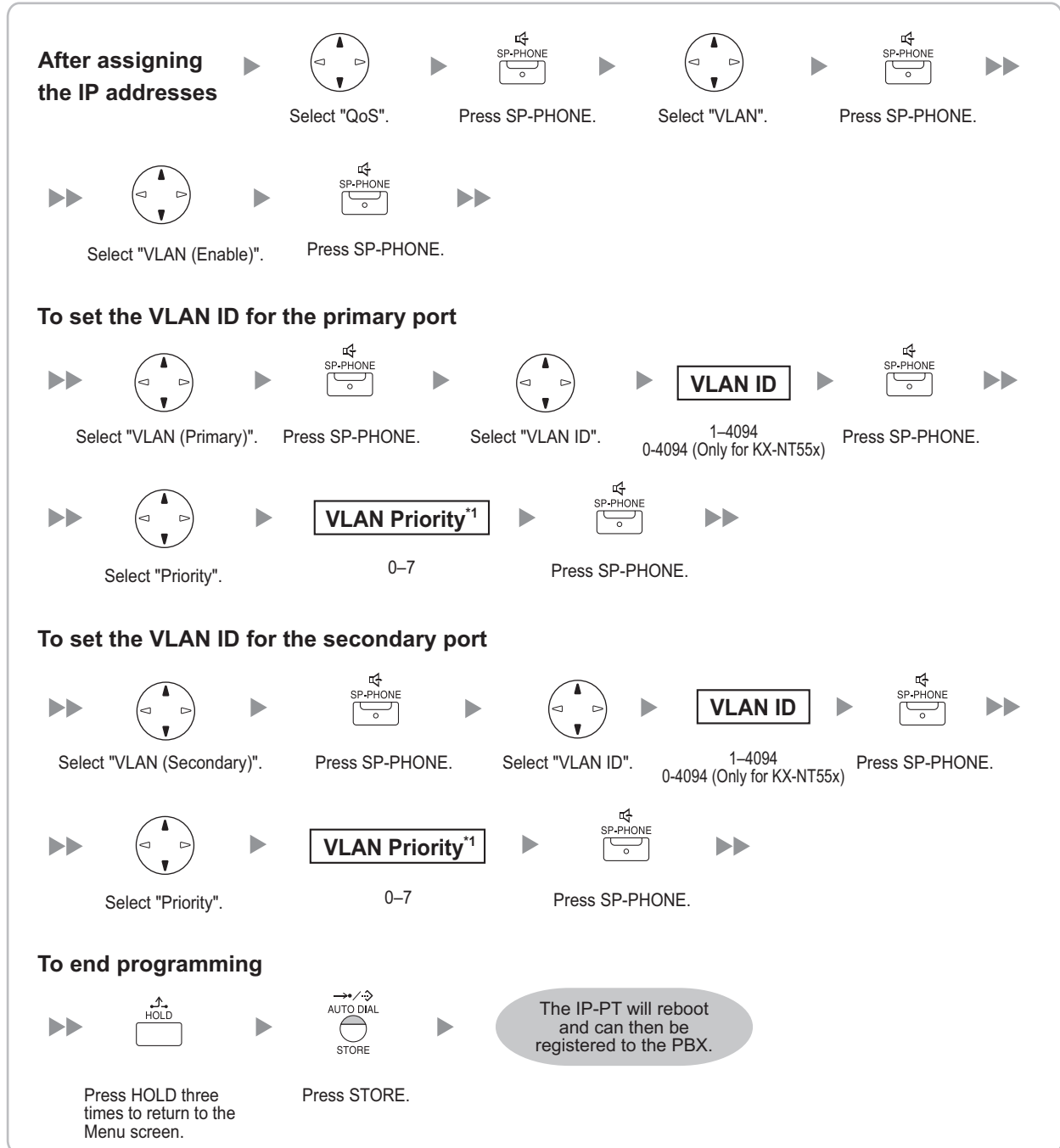

\*1 The VLAN priority of the primary port must be set higher than the priority of the secondary port. The larger the number, the higher the priority.

### Note

- **For KX-NT511 Users**

For details about operating the PROGRAM button and other buttons, refer to "For IP-PTs" in "5.7.1 Assigning IP Addressing Information".



**KX-NT265 (Software version 2.00 or later only)**

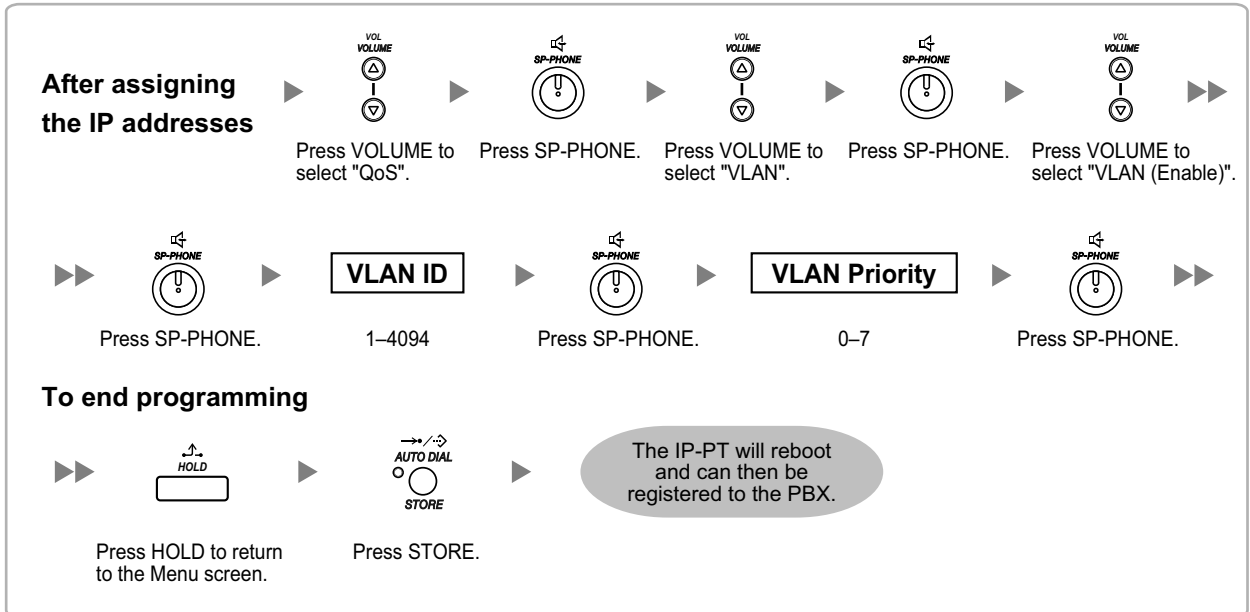

## 5.7.3 Setting LLDP Parameters

LLDP-MED is a technique for IP telephones to obtain VLAN settings automatically from a network device, such as a Network Switch.

If you are using an IP telephone equipped with two LAN ports, the primary and secondary ports of the IP telephone can be placed on different VLANs by assigning a separate VLAN ID to each port. Follow the procedure below for all IP-PTs on the network, using appropriate VLAN IDs.

### **Note**

- This feature is available only for KX-NT511, KX-NT551, KX-NT553, and KX-NT556 IP-PTs.
- VLAN settings configured through PT programming have priority over VLAN settings configured through the LLDP-MED function.
- To enable or disable the sending of LLDP packets from KX-NS300, consult your dealer.

## KX-NT553/KX-NT556

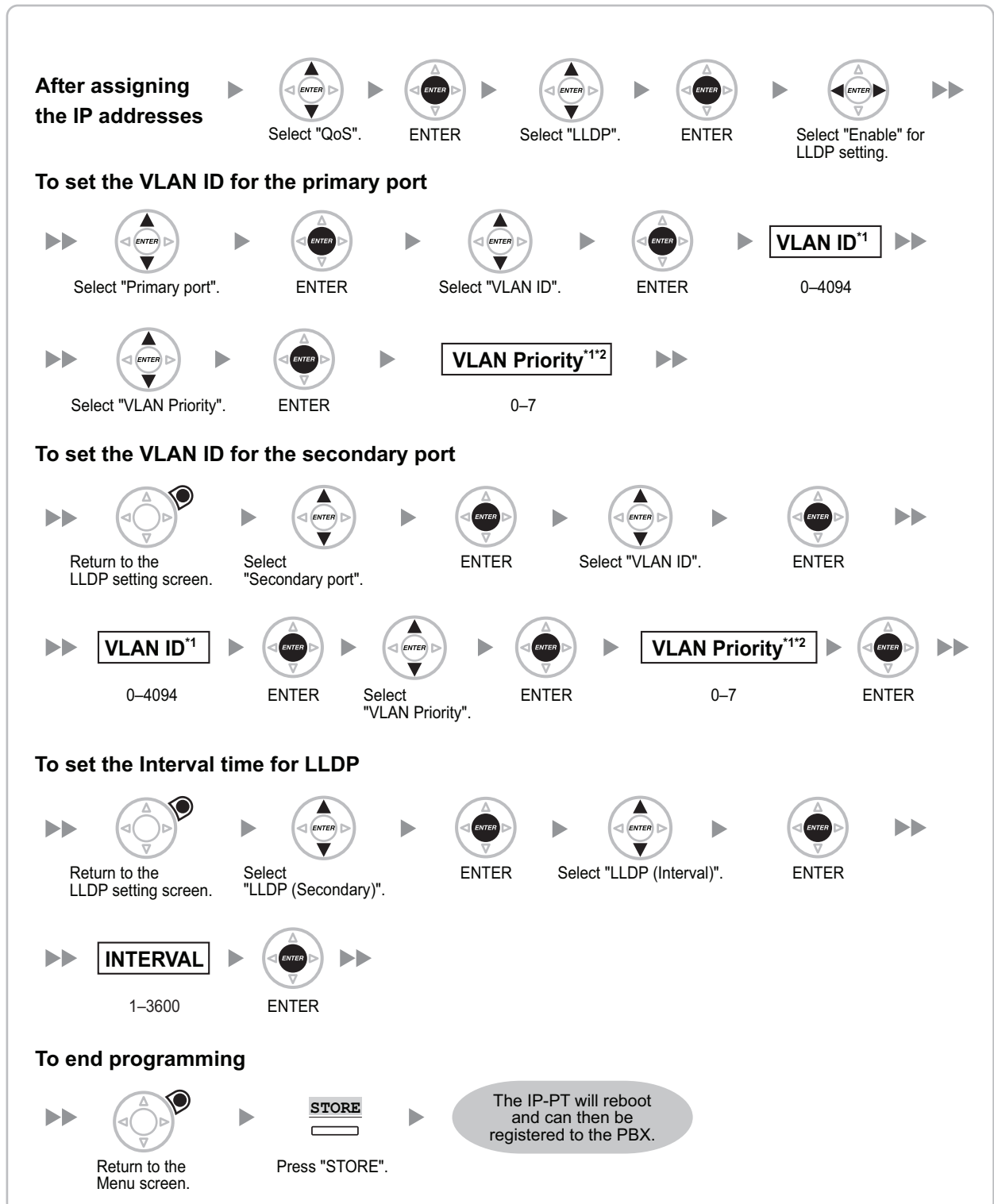

<sup>1</sup> The VLAN ID and the VLAN priority are set automatically for the primary port; these are reference only. However, the VLAN ID and the VLAN priority for secondary port must be set manually.

<sup>2</sup> The VLAN priority of the primary port must be set higher than the priority of the secondary port. The larger the number, the higher the priority.

KX-NT511/KX-NT551

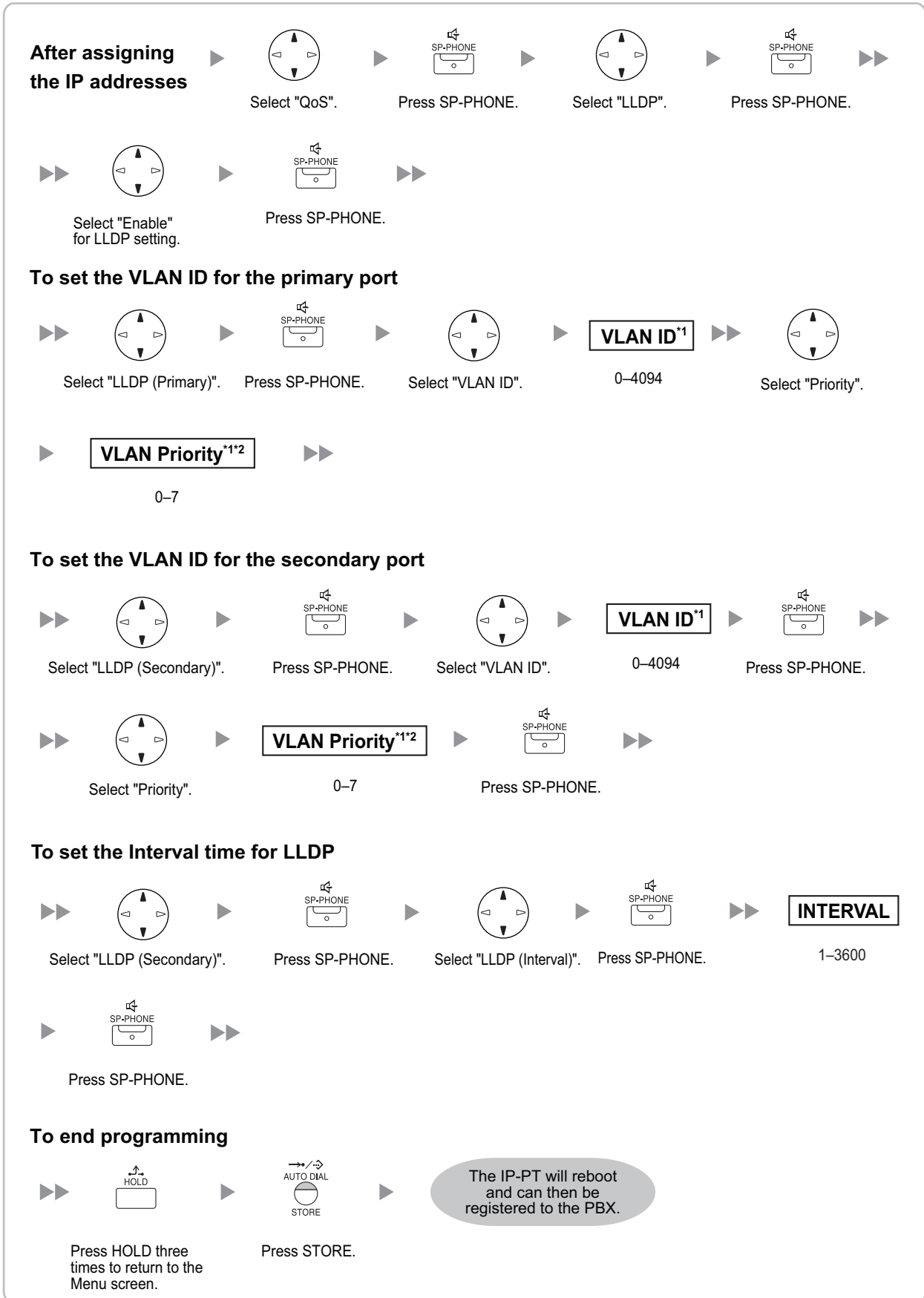

#### **Note**

- **For KX-NT511 Users**

For details about operating the PROGRAM button and other buttons, refer to "For IP-PTs" in "5.7.1 Assigning IP Addressing Information".

- <sup>\*1</sup> The VLAN ID and the VLAN priority are set automatically for the primary port; these are reference only. However, the VLAN ID and the VLAN priority for secondary port must be set manually.
- <sup>\*2</sup> The VLAN priority of the primary port must be set higher than the priority of the secondary port. The larger the number, the higher the priority.

## 5.7.4 Setting Diffserv Parameters

Differentiated Services (DiffServ, or DS) is an IP-based QoS technique used to control QoS of VoIP communications by setting the DS field in the header of IP packets. Consult your network administrator for the appropriate setting values for the DS field.

Follow the procedure below to set the Diffserv parameters. Only KX-NT300 series IP-PTs, KX-NT500 series IP-PTs, and KX-NT265 IP-PTs can be used to set the parameters.

### KX-NT300 series (except KX-NT321) and KX-NT500 series (except KX-NT511 and KX-NT551)

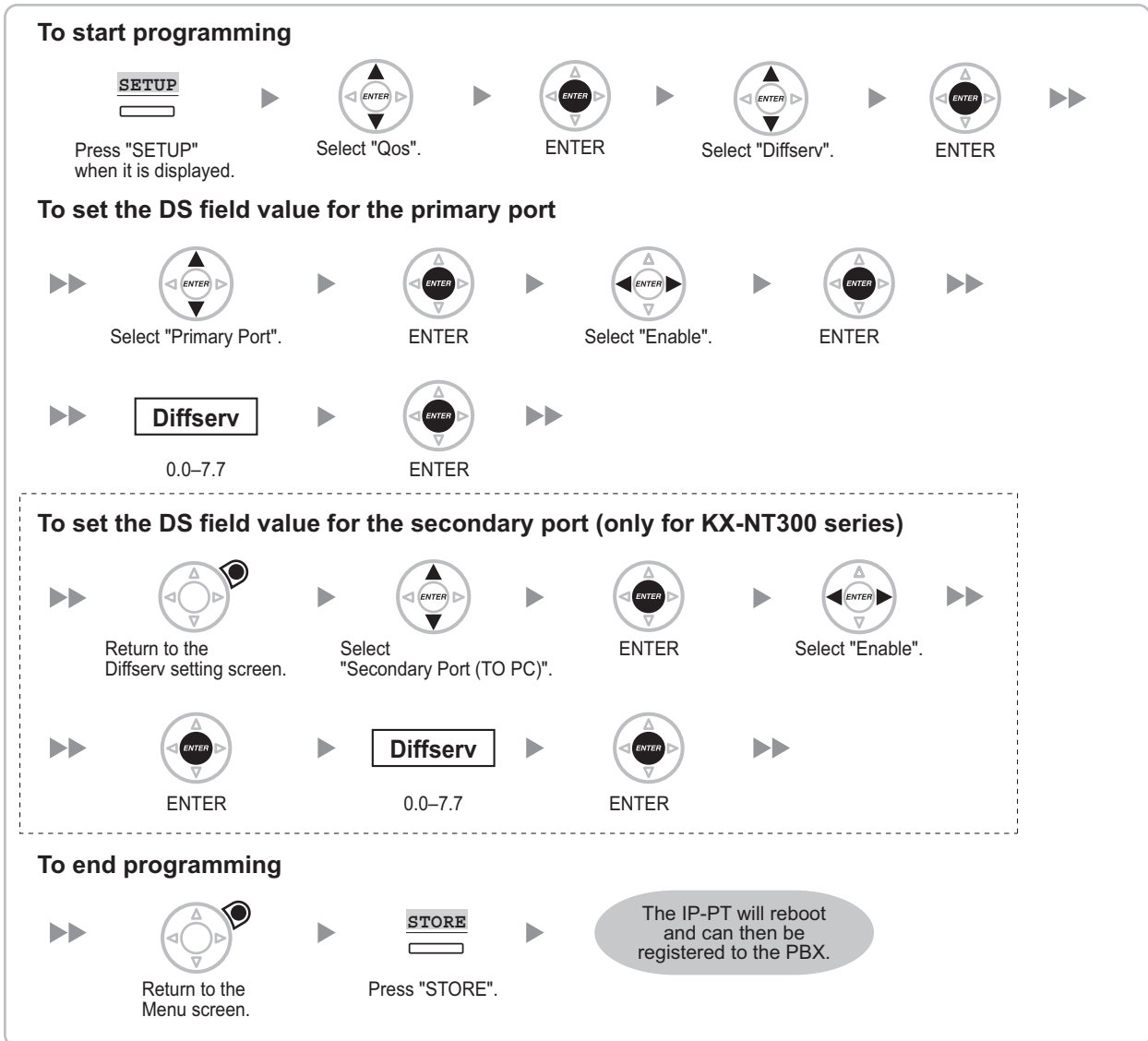

**Note**

The illustrations may differ from the buttons on your telephone.

## KX-NT321/KX-NT511/KX-NT551

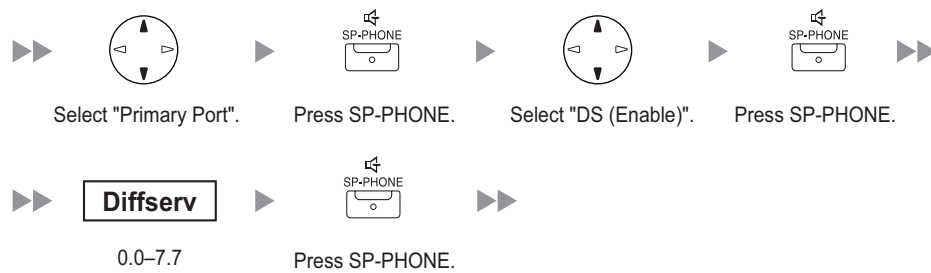
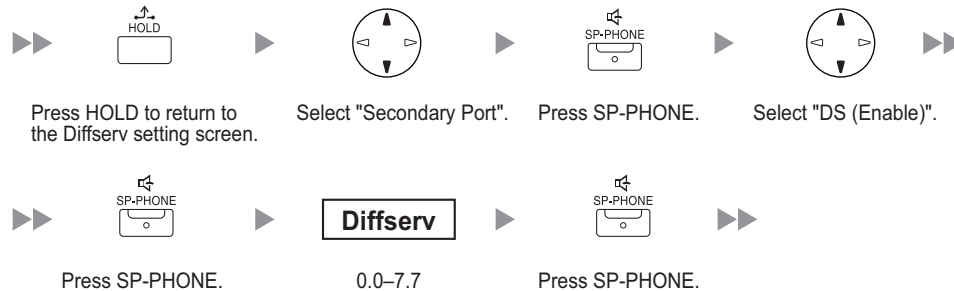
**To start programming****To set the DS field value for the primary port****To set the DS field value for the secondary port (only for KX-NT300 series)****To end programming****Note**

- **For KX-NT511 Users**  
For details about operating the PROGRAM button and other buttons, refer to "For IP-PTs" in "5.7.1 Assigning IP Addressing Information".

**KX-NT265 (Software version 2.00 or later only)**

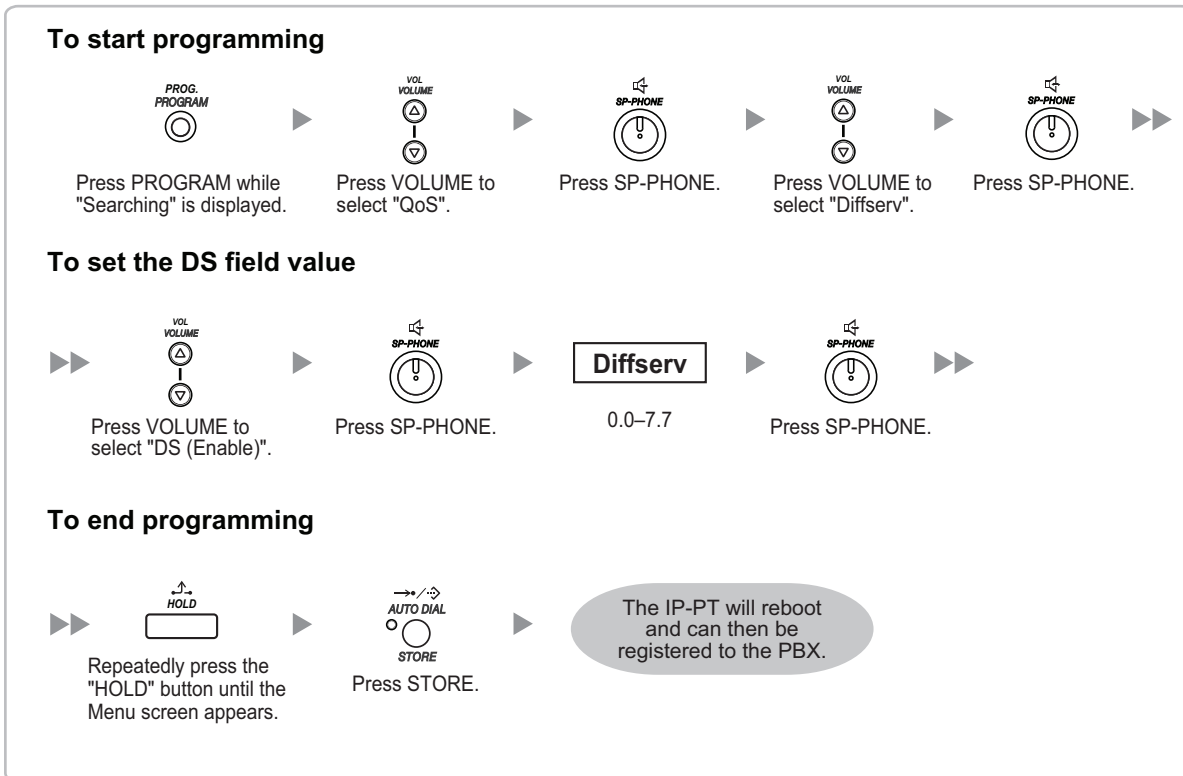



## 5.7.5 Configuration of IP Ports

A KX-NT300 series IP-PT user, KX-NT500 series IP-PT user, or KX-NT265 IP-PT user can configure the port number of PTAP, DHCP, and FTP ports. Consult your network administrator to check whether the configuration of the IP ports is required.

Follow the procedure below to configure the port number of the IP ports.

### **Note**

- If you wish to change the port number back to default, enter **0** as the port number for the desired port.
- To delete 1 character, use "**CLEAR**" for KX-NT300 series IP-PTs and KX-NT500 series IP-PTs, or use **[TRANSFER]** for KX-NT265, KX-NT321, KX-NT511 and KX-NT551.

## 5.7.5 Configuration of IP Ports

### KX-NT300 series (except KX-NT321) and KX-NT500 series (except KX-NT511 and KX-NT551)

#### To start programming



#### To configure the port number of PTAP Ports

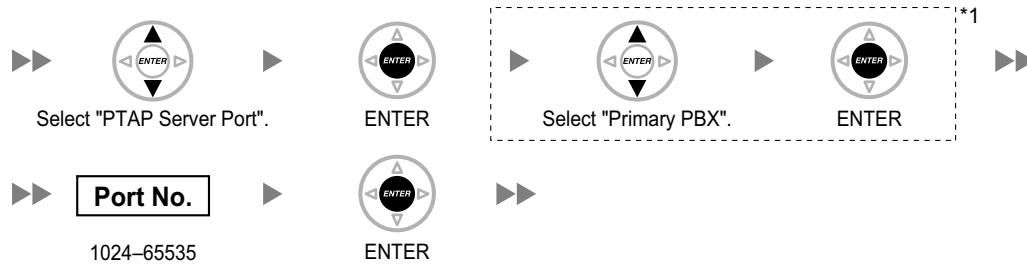

#### To configure the port number of PTAP Ports for the Secondary PBX<sup>\*2</sup>

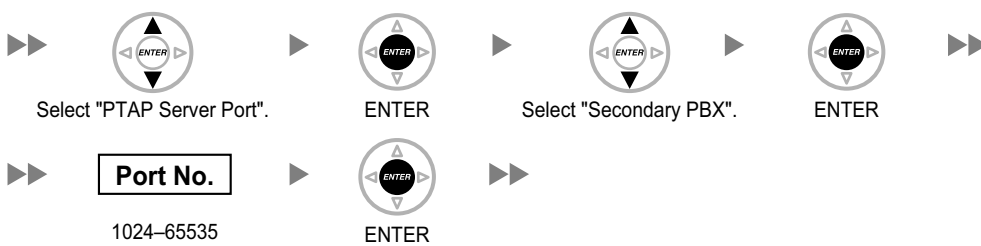

#### To configure the port number of DHCP Ports

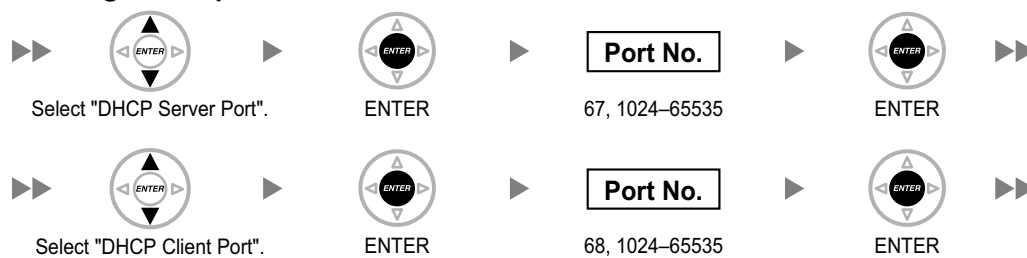

Continued on next page

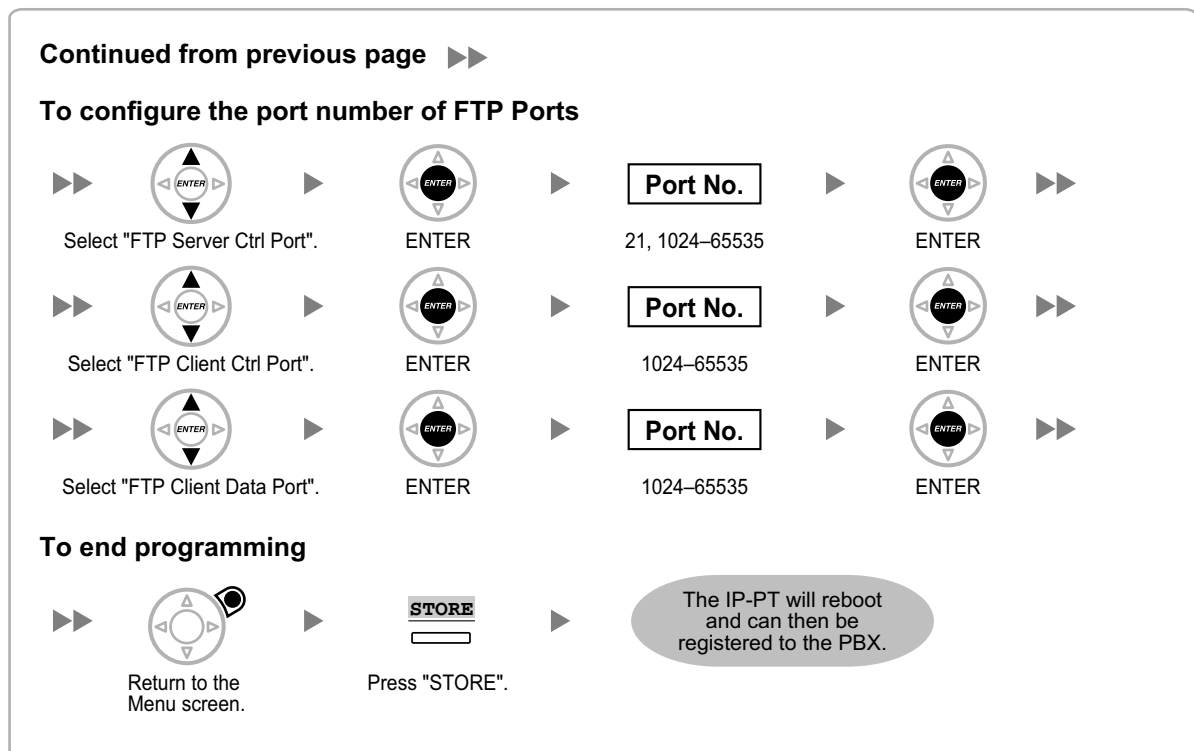

\*1 For KX-NT300 series (Software version 2.00 or later only) and KX-NT500 series (Software version 1.00 or later only)

\*2 Optional for KX-NT300 series (Software version 2.00 or later only) and KX-NT500 series (Software version 1.00 or later only)

### **Note**

The illustrations may differ from the buttons on your telephone.

**KX-NT321/KX-NT511/KX-NT551**





**To start programming**

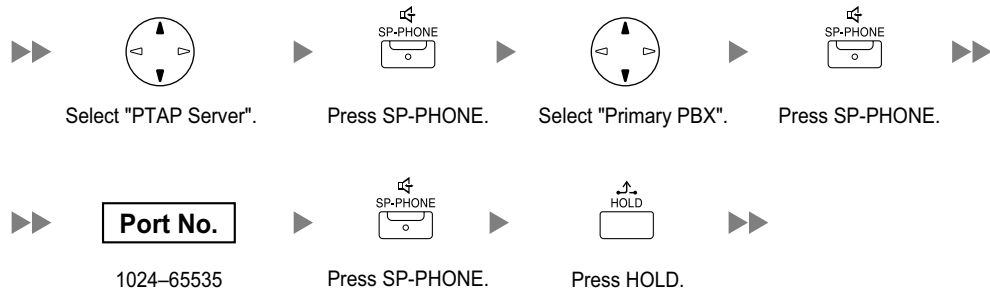



**To configure the port number of PTAP Ports**



**To configure the port number of PTAP Ports for the Secondary PBX (if required)**

►►  ►  ►  ►  ►►

Select "PTAP Server".      Press SP-PHONE.      Select "Secondary PBX".      Press SP-PHONE.

►► **Port No.** ►  ►  ►►

1024–65535      Press SP-PHONE.      Press HOLD.

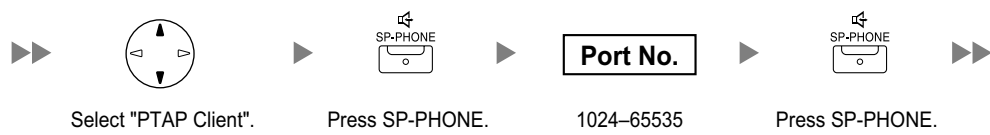

**To configure the port number of DHCP Ports**

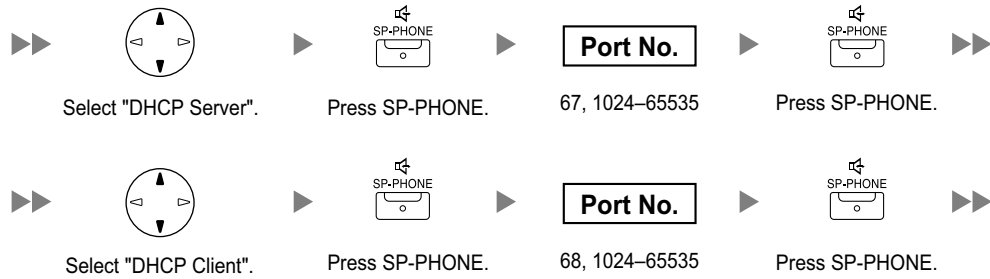

►► **Continued on next page**

Continued from previous page ▶▶

### To configure the port number of FTP Ports

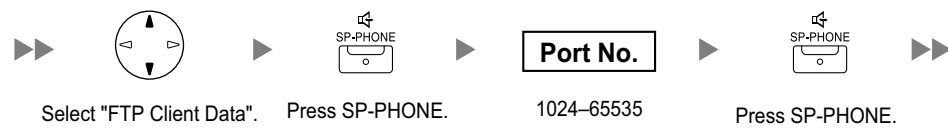
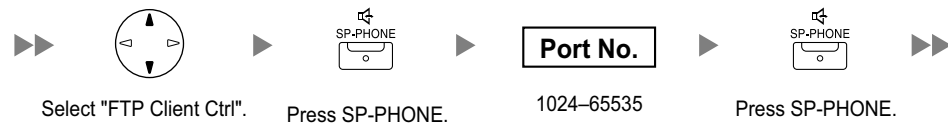
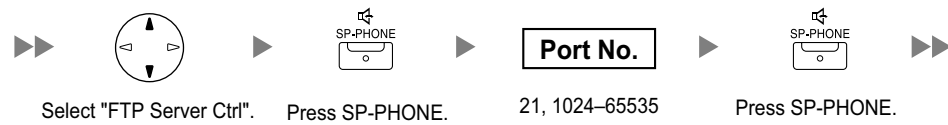

### To end programming

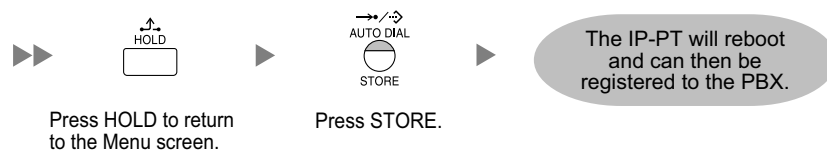

### Note

- **For KX-NT511 Users**  
For details about operating the PROGRAM button and other buttons, refer to "For IP-PTs" in "5.7.1 Assigning IP Addressing Information".

**KX-NT265 (Software version 2.00 or later only)**

**To start programming**

Press PROGRAM while "Searching" is displayed. Press VOLUME to select "IP Port". Press SP-PHONE. **Password** 7678 Press SP-PHONE.

**To configure the port number of PTAP Ports**

Press VOLUME to select "PTAP Server". Press SP-PHONE. **Port No.** 1024-65535 Press SP-PHONE.

Press VOLUME to select "PTAP Client". Press SP-PHONE. **Port No.** 1024-65535 Press SP-PHONE.

**To configure the port number of DHCP Ports**

Press VOLUME to select "DHCP Server". Press SP-PHONE. **Port No.** 67, 1024-65535 Press SP-PHONE.

Press VOLUME to select "DHCP Client". Press SP-PHONE. **Port No.** 68, 1024-65535 Press SP-PHONE.

**To configure the port number of FTP Ports**

Press VOLUME to select "FTP Server Ctrl". Press SP-PHONE. **Port No.** 21, 1024-65535 Press SP-PHONE.

Press VOLUME to select "FTP Client Ctrl". Press SP-PHONE. **Port No.** 1024-65535 Press SP-PHONE.

Press VOLUME to select "FTP Client Data". Press SP-PHONE. **Port No.** 1024-65535 Press SP-PHONE.

**To end programming**

Press HOLD to return to the Menu screen. Press STORE. The IP-PT will reboot and can then be registered to the PBX.

## 5.7.6 ECO mode (KX-NT500 series only)

ECO mode allows a KX-NT500 series IP-PT to consume less power than in normal mode.

To start ECO mode, follow the procedure below.

### KX-NT553/KX-NT556

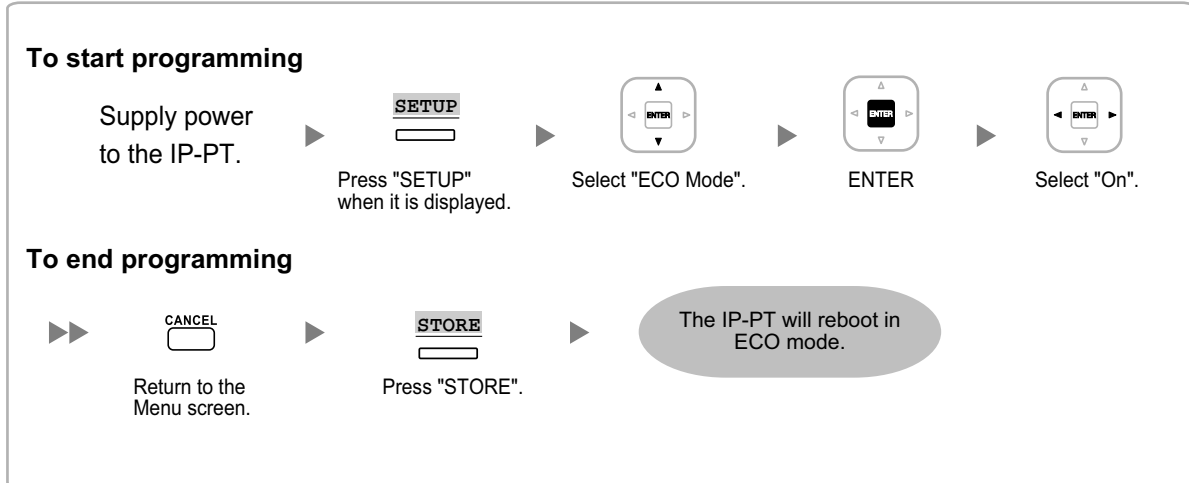

### KX-NT511/KX-NT551

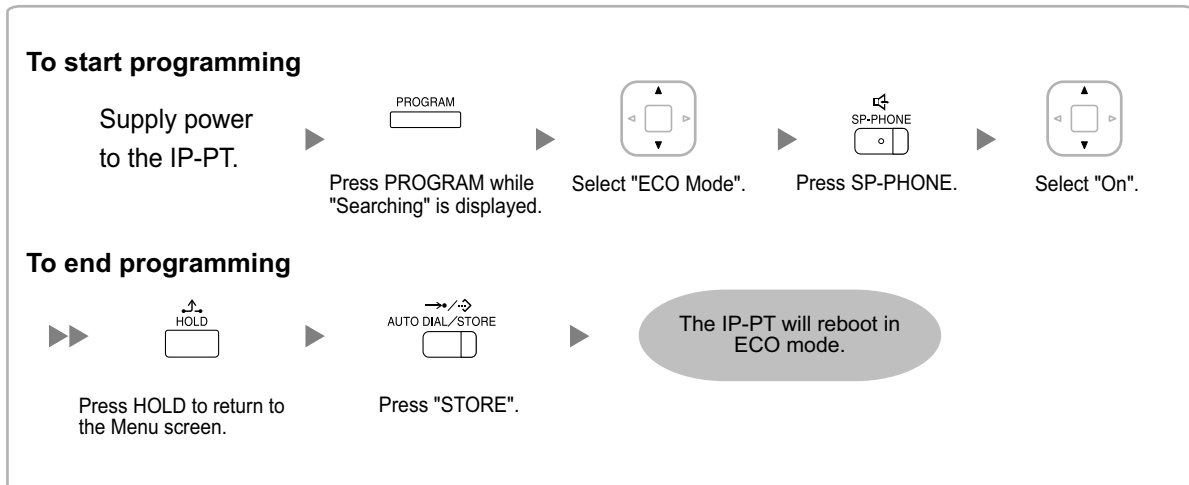

#### Notice

- When a KX-NT500 series IP-PT is in ECO mode, the following limitations are applied:
  - The second Ethernet port is disabled.
  - The port of the switching hub to which the telephone is connected must be 10 Mbps (Fixed)/full duplex.
- For KX-NT500 series IP-PTs (software version V1.010 or later), you can specify the connection mode (Auto Negotiation, 10 Mbps/full duplex, 10 Mbps/half duplex, 100 Mbps/full duplex, 100 Mbps/half duplex). If a connection with Auto Negotiation fails, the connection will be made in either 10 Mbps/half duplex or 100 Mbps/half duplex.

#### Note

- **For KX-NT511 Users**

### 5.7.6 ECO mode (KX-NT500 series only)

For details about operating the PROGRAM button and other buttons, refer to "For IP-PTs" in "5.7.1 Assigning IP Addressing Information".

To exit from ECO mode, turn off the KX-NT500 series IP-PT, and then follow the procedure below.

#### KX-NT553/KX-NT556

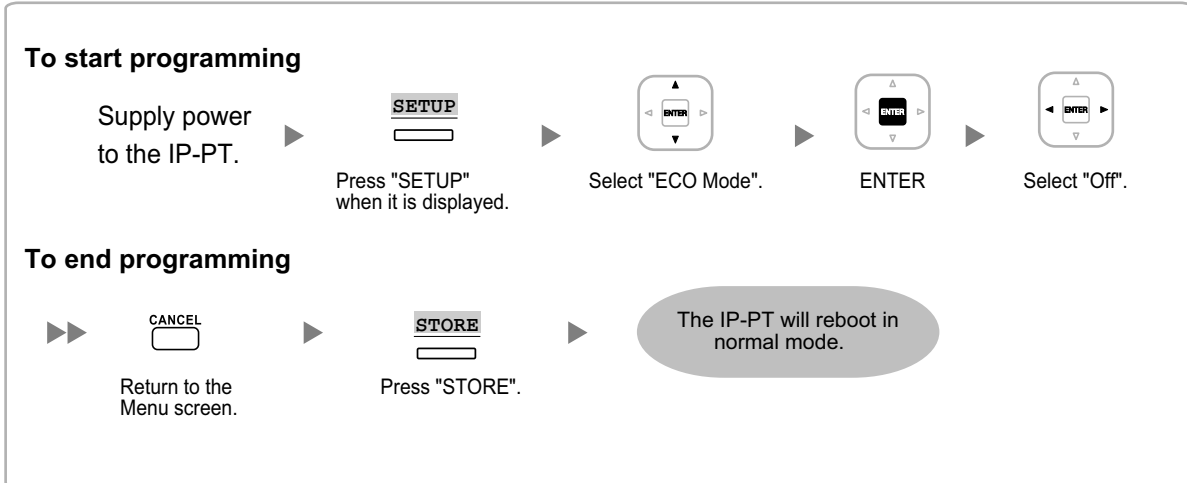

#### KX-NT511/KX-NT551

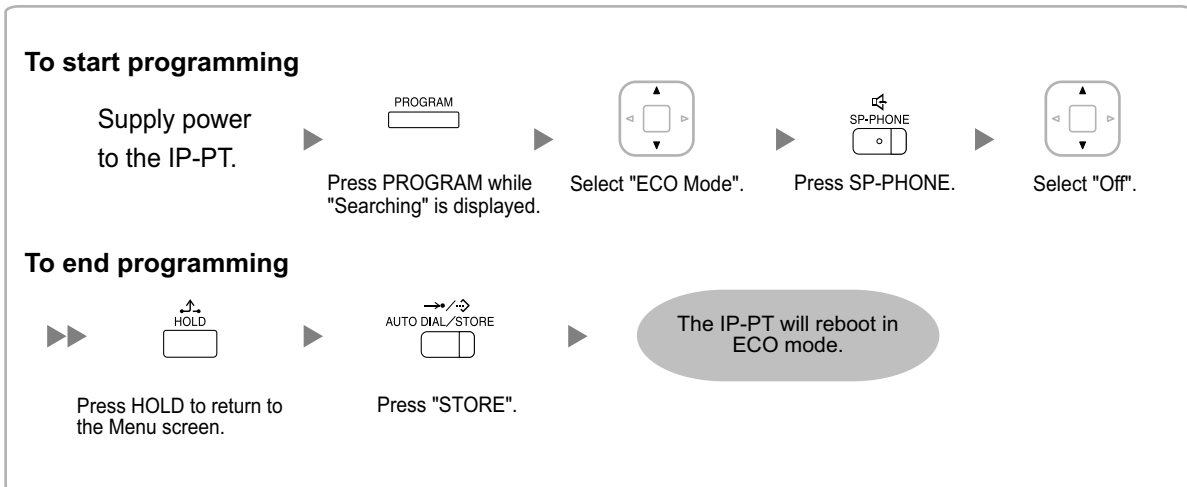

#### Note

- **For KX-NT511 Users**

For details about operating the PROGRAM button and other buttons, refer to "For IP-PTs" in "5.7.1 Assigning IP Addressing Information".



## 5.8 Registering IP Telephones

### 5.8.1 Registering IP Telephones

After the programming of the PBX and IP telephones is finished (refer to "5.7 Assigning Networking Information to IP Telephones"), the IP telephones must be registered to the PBX. The procedure for registering IP telephones differs according to the IP terminal registration mode specified during the Easy Setup Wizard. This setting can also be changed in the **Site Property—Main** screen of the Web Maintenance Console (refer to "9.2.2 PBX Configuration—[1-1] Configuration—Slot—System Property—Site—Main—◆ IP Terminal Registration Mode" in the PC Programming Manual). Refer to the following table:

IP Terminals	IP Terminal Registration Mode		
	Full Automatic Mode	Extension Number Input Mode	Manual Mode
IP-PTs	✓	✓	✓
KX-UT Series SIP Phones	✓	✓ <sup>*1</sup>	✓
Non-KX-UT series SIP phones	✓ <sup>*2</sup>	✓ <sup>*2</sup>	✓
IP-CSs <sup>*3</sup>			✓

✓: Available

<sup>\*1</sup> KX-UT series SIP phones will be registered automatically, in the same way as Full Automatic mode.

<sup>\*2</sup> Non-KX-UT series SIP phones must always be registered to the PBX manually, even if Full Automatic mode or Extension Number Input mode is selected.

<sup>\*3</sup> IP-CSs must always be registered to the PBX manually. For details about registering IP-CSs, refer to the Quick Installation Guide for the IP-CS.

#### Notice

You can specify an air sync group for IP-CSs after registration only when IP Terminal Registration Mode is set to "Manual Mode".

#### Note

- For KX-UT series SIP phones, the SIP extension password is automatically set to "1234".
- For IP softphones, follow the same registration procedure as IP-PTs.

### Full Automatic Mode

If networking settings have been completed, when IP-PTs or KX-UT series SIP phones are connected to the same network as the PBX, they will be registered automatically. No registration procedure is required.

### Extension Number Input Mode

#### For IP-PTs

If networking settings have been completed, when IP-PTs are connected to the same network as the PBX, they will be registered automatically, but extension numbers for the IP-PTs will not be set. Follow the procedure below to register an extension number to complete registration.

1. After completing networking settings, connect the IP-PT to the same network as the PBX. The screen to enter the extension number is displayed on the IP-PT.

## 5.8.1 Registering IP Telephones

2. Enter an extension number.

### Note

When no extension number is entered in this step, the process will time out and the IP-PT will be registered without an extension number.

3. Press **[ENTER]**<sup>1</sup> on the IP-PT.
4. Press **[PAUSE]**<sup>2</sup> or **"EXIT"** on the IP-PT.

<sup>1</sup> For KX-NT551/KX-NT321 users, press **[AUTO DIAL/STORE]**.  
For KX-NT511 users, press **[CONF/STORE]**.

For models other than the above models that do not have the applicable buttons, consult your dealer.

<sup>2</sup> For KX-NT511 users, go off-hook, and then go on-hook.

### For KX-UT Series SIP Phones

If networking settings have been completed, when KX-UT series SIP phones are connected to the same network as the PBX, they will be registered automatically as same as when they are registered in Full Automatic mode. No registration procedure is required.

### Note

- No more than 64 IP-PTs can register extension numbers at the same time.
- If an extension number that is input for an IP-PT has already been set to another extension, registration by this mode will fail.  
Note that some extension numbers are pre-configured to other extensions by default. Avoid using such numbers, or delete them before starting the registration process.

## Manual Mode

### For IP-PTs or KX-UT Series SIP Phones

After connecting IP-PTs or KX-UT series SIP phones to the PBX over a network, register those IP terminals to the PBX manually.

Follow the procedure below for registration.

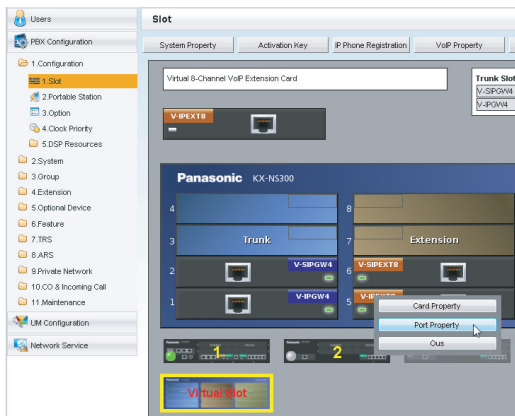

1.
  - a. Click **Setup** → **PBX Configuration** → **Configuration** → **Slot**.
  - b. Place the mouse cursor over the **Virtual Slot**, and in the menu that appears, click **Select Shelf**.
  - c. **For IP-PTs:**  
Move the mouse pointer over the **V-IPEXT8** card (Virtual 8-Channel VoIP Extension Card).  
**For KX-UT series SIP phones:**  
Move the mouse pointer over the **V-UTEXT8** card (Virtual UT Extension Card).  
A menu will be shown under the mouse pointer.
  - d. Click **Port Property**.

**To register the IP-PT or KX-UT series SIP phone by entering the MAC address directly:**

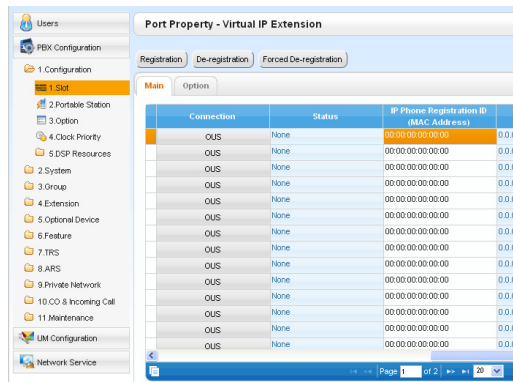

- If the **Connection** column for the port is **INS**, click **INS**, and then click **OUS** on the dialogue box to change the port's status.
- Enter the MAC address of the IP-PT or SIP phone in the **IP Phone Registration ID (MAC Address)** cell.
- Click **Apply**. Once the IP-PT or SIP phone is successfully registered, its status will update to show "Registered".
- In the **Connection** column for the port, click **OUS**, and then click **INS** on the dialogue box to change the port's status.
- For KX-UT series SIP phones only: Follow the procedure below to change the **IP Terminal Registration Mode** from **Manual** to **Full Automatic**.
  - Click **Setup** → **PBX Configuration** → **Configuration** → **Slot** → **System Property** → **Site** → **Main**.
  - In the **Main** tab, select **Full Automatic** for **IP Terminal Registration Mode**.
  - Click **OK**.

To register the IP-PT or KX-UT series SIP phone using the wizard:

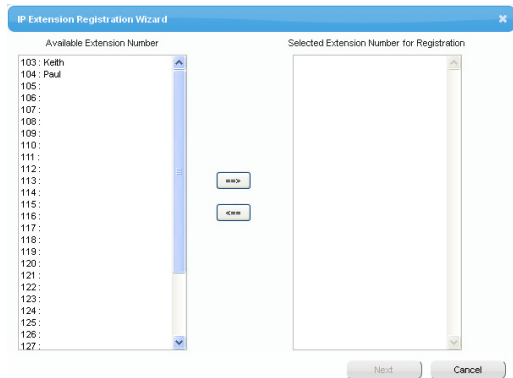

- Click **Registration**. A dialogue box will appear. Non-registered (available) extension numbers and names are displayed on the left.
- Highlight numbers and names and click the right arrow to select them for registration, and then click **Next**.
  - Click **Next**. A screen will appear with information on the current IP-PT or SIP phone extension number and name, and index number for programming.
 

**Note**

    - If the IP-PT or SIP phone has been connected to the LAN and power has been turned on, the IP address of the PBX will be assigned automatically.
    - If not, connect the IP-PT or SIP phone to the LAN and turn the power on within 15 minutes after this operation is done. The IP address of the PBX will then be assigned automatically.
- If the registration is still in progress, the dialogue box will show "Registration Executing". If the registration is successful, the dialogue box will show "Registration Completed". Click **Close**. Once the IP-PT or SIP phone is successfully registered, its status will update to show "Registered".

## 5.8.1 Registering IP Telephones

### For Non-KX-UT Series SIP Phones

After connecting non-KX-UT series SIP phones to the PBX over a network, register those IP terminals to the PBX manually.

Follow the procedure below for registration.



1.
  - a. Click **Setup** → **PBX Configuration** → **Configuration** → **Slot**.
  - b. Place the mouse cursor over the **Virtual Slot**, and in the menu that appears, click **Select Shelf**.
  - c. Move the mouse pointer over the **V-SIPEXT8** card (Virtual 8-Channel SIP Extension Card). A menu will be shown under the mouse pointer.
  - d. Click **Port Property**.

Slot	Port	Extension Number
1		135
2		136
3		137
4		138
5		139
6		140
7		141
8		142
9		143
10		144
11		145

2. Assign extension numbers to the SIP extensions.
  - If the Automatic Extension Number Set for Extension Card feature is enabled, the extension numbers of SIP extension are automatically assigned. To programme this feature, refer to "9.35 PBX Configuration—[1-3] Configuration—Option—◆ New Card Installation—Automatic Extension Number Set for Extension Card" in the PC Programming Manual.
  - If not, enter the extension number for each SIP extension manually.

Port Property - Virtual SIP Extension

Copy to

No. *	Site	Shelf	Slot	Port	Extension Number	Password	Connection
1	1	Virtual	48	1	135	1234	OUS
2	1	Virtual	48	2	136	1234	OUS
3	1	Virtual	48	3	137	1234	OUS
4	1	Virtual	48	4	138	1234	OUS
5	1	Virtual	48	5	139	1234	OUS
6	1	Virtual	48	8	140	1234	OUS
7	1	Virtual	48	7	141	1234	OUS
8	1	Virtual	48	9	142	1234	OUS
9	1	Virtual	48	9	143	1234	OUS
10	1	Virtual	48	10	144	1234	OUS
11	1	Virtual	48	11	145	1234	OUS
12	1	Virtual	48	12	146	1234	OUS

3. Set passwords for the SIP extensions.
  - a. Click the cell in the **Connection** column for each SIP extension you wish to register. The Command Connection screen appears.
  - b. Click **OUS**.
  - c. Enter a password in the Password cell for each SIP extension.
  - d. Click **Apply**.
  - e. Click the cell in the **Connection** column for each SIP extension to which a password has been assigned. The Command Connection screen appears.
  - f. Click **INS**.
  - g. Click **OK**.

Copy to Password

Copy Extension Number to Password :

1 : 1350  
 2 : 1360  
 3 : 1370  
 4 : 1380  
 5 : 1390  
 6 : 1400  
 7 : 1410  
 8 : 1420  
 9 : 1430  
 10 : 1440  
 11 : 1450  
 12 : 1460  
 13 : 1470  
 14 : 1480  
 15 : 1490  
 16 : 1500  
 17 : 1510  
 18 : 1520  
 19 : 1530  
 20 : 1540  
 21 : 1550  
 22 : 1560  
 23 : 1570  
 24 : 1580

Select All   Execute   Cancel

#### Note

- Alternatively, it is possible to set an extension number as a password for each SIP extension automatically.
- In order to set the password automatically, do the following in substitution for step c of the procedure above.
  - a. Click **Copy to**. A screen will appear with information on assigned extension numbers for SIP extensions.
  - b. Click **Select All**.
  - c. Click **Execute** to copy each Extension Number to Password.
  - d. Click **Yes**.
  - e. Click **OK** to return to the Port Property screen.
- When copying extension numbers to passwords, you can also use the  icon on the bottom left of the Virtual SIP Extension Port Property screen.

## 5.8.1 Registering IP Telephones

---

4. Programme the SIP extension you wish to register.
  - a. Set the IP address of the PBX, extension number, and password in the corresponding fields for your SIP extension.
  - b. Send a request from the SIP extension to the PBX for registration.
    - If the authentication information of the SIP extension and the PBX match, the registration is successful.

### **Note**

- When programming the SIP extension, the names of the corresponding fields may differ depending on the type of SIP phone you are using.
- For details about the actual operation of SIP phones, refer to the documentation of the SIP phone.
- For certain SIP phones, you may need to set a Sign-in name, which should consist of the extension number and the IP address of the PBX (e.g., 350@192.168.0.101).

## 5.8.2 De-registering IP Telephones

### De-registration of IP-PTs or KX-UT Series SIP Phones

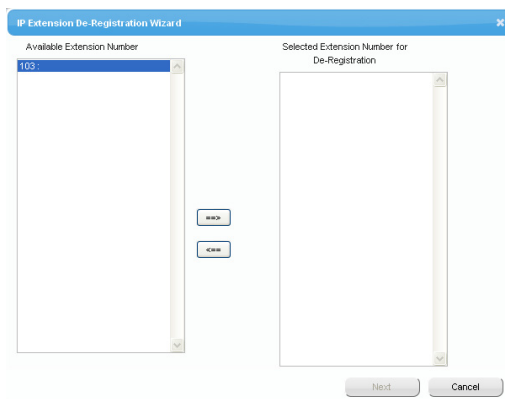
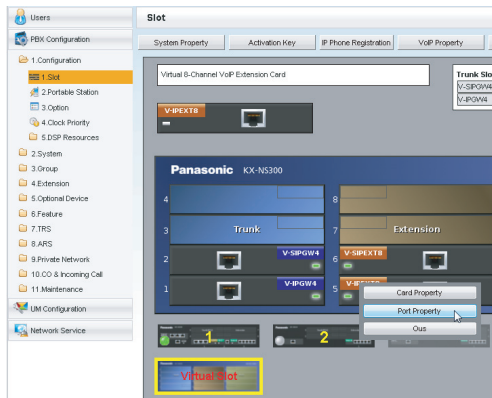

1. Make sure the **IP Terminal Registration Mode** is set to **Manual**.
  - a. Click **Setup** → **PBX Configuration** → **Configuration** → **Slot** → **System Property** → **Site** → **Main**.
  - b. In the **Main** tab, select **Manual** for **IP Terminal Registration Mode**.
  - c. Click **OK**.
2.
  - a. Click **Setup** → **PBX Configuration** → **Configuration** → **Slot**.
  - b. Place the mouse cursor over the **Virtual Slot**, and in the menu that appears, click **Select Shelf**.
  - c. **For IP-PTs:**  
Move the mouse pointer over the **V-IPEXT8** card (Virtual 8-Channel VoIP Extension Card).  
**For KX-UT series SIP phones:**  
Move the mouse pointer over the **V-UTEXT8** card (Virtual UT Extension Card).  
A menu will be shown under the mouse pointer.
  - d. Click **Port Property**.
3. Click **De-registration**.  
A dialogue box will appear. Registered extension numbers and names are displayed on the left.
4.
  - a. Highlight numbers and names and click the right arrow to select them for de-registration.
  - b. Click **Next**.  
A dialogue box will appear.
  - c. Click **Confirm**.
    - If the de-registration is successful, the dialogue box will show "De-registration succeed!".
  - d. Click **Close**.

Once the IP-PT or SIP phone is successfully de-registered, the status of the IP telephone will update to show "None".

### Forced De-registration of IP-PTs or KX-UT Series SIP Phones

Follow the steps below to forcibly de-register an IP-PT when normal de-registration was unsuccessful.

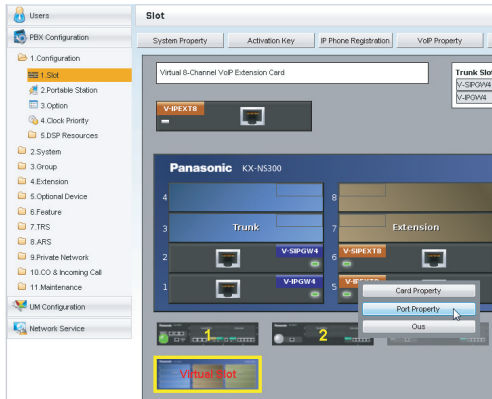

- Click **Setup** → **PBX Configuration** → **Configuration** → **Slot**.
  - Place the mouse cursor over the **Virtual Slot**, and in the menu that appears, click **Select Shelf**.
  - For IP-PTs:**  
Move the mouse pointer over the **V-IPEXT8** card (Virtual 8-Channel VoIP Extension Card).  
**For KX-UT series SIP phones:**  
Move the mouse pointer over the **V-UTEXT8** card (Virtual UT Extension Card).  
A menu will be shown under the mouse pointer.
  - Click **Port Property**.
- Click **Forced De-registration**.  
A dialogue box will appear. Registered extension numbers and names are displayed on the left.
- Highlight numbers and names and click the right arrow to select them for de-registration.
  - Click **Next**.  
A dialogue box will appear.
  - Click **OK**.  
A dialogue box will appear.
  - Click **Confirm**.
    - If the de-registration is successful, the dialogue box will show "Forced de-registration succeed!".
  - Click **Close**.

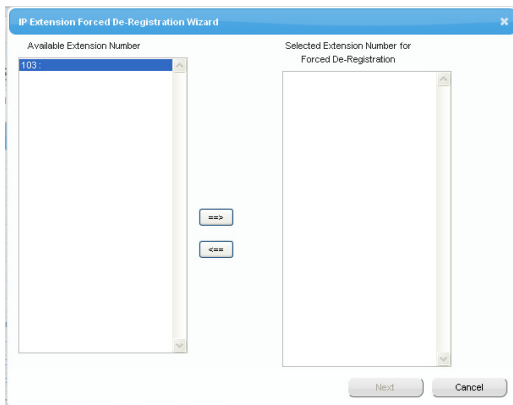

Once the IP-PT or SIP phone is successfully de-registered, the status of the IP telephone will update to show "None".



## De-registration of Non-KX-UT Series SIP Phones

The de-registration of non-KX-UT series SIP phones is carried out by deleting either the extension number or password registered in the PBX.

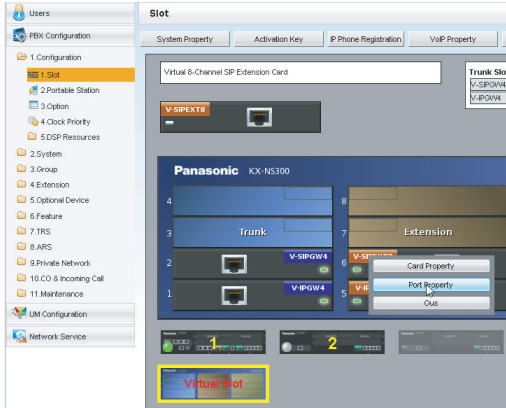

1.
  - a. Click **Setup** → **PBX Configuration** → **Configuration** → **Slot**.
  - b. Place the mouse cursor over the **Virtual Slot**, and in the menu that appears, click **Select Shelf**.
  - c. Move the mouse pointer over the **V-SIPEXT8** card (Virtual 8-Channel SIP Extension Card). A menu will be shown under the mouse pointer.
  - d. Click **Port Property**.

2.
  - a. Click the cell in the Connection column for the port of the SIP phone to de-register.
  - b. In the Command window, click **OUS** to change the status of the port to "OUS".
3. Repeat step 2 for each SIP phone to de-register.
4. Delete either the extension number or password for the SIP phone to de-register, as shown here.
5. Click **OK**.

Slot	Port	Extension Number	Password
48	1	135	1234
48	2	136	1234
48	3	137	1234
48	4	138	1234
48	5	139	1234
48	6	140	1234
48	7	141	1234
48	8	142	1234
48	9	143	1234
48	10	144	1234
48	11	145	1234
48	12	146	1234
48	13	147	1234
48	14	148	1234

## 5.8.3 Installing SIP Phones at a Remote Site

If an SBC (Session Border Controller) is present on the same local network as the KX-NS300, you can install SIP phones at remote sites without needing to configure special network settings (NAT traversal, etc.). This section provides information about the procedure for connecting SIP Phones at a remote site that has SBC hardware.

When SIP phones in remote sites use the internet to communicate with the PBXs, use the HTTPS protocol for security. If the connection is within a VPN and protected, you may use the HTTP protocol.

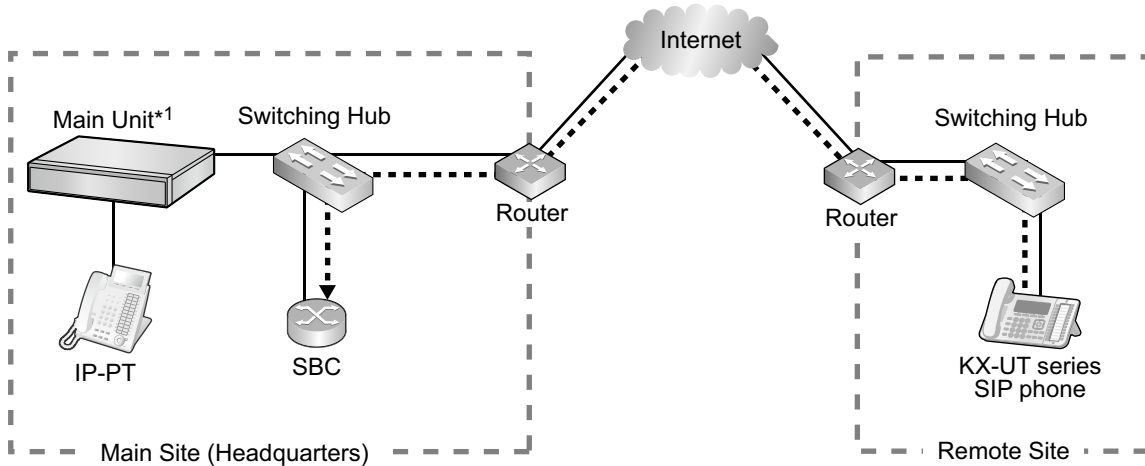

.....➔ : RTP packets  
 \*1 KX-NS300

### Note

- Install the SBC in the same LAN as the KX-NS300.
- A KX-NS300 can work with only one SBC. Also, multiple sites can share an SBC.
- A KX-NS300 can support up to 20 remote extensions at the same time via SBC when using the HTTPS protocol.
- All the RTP packets in between the main site and the remote site is routed to the SBC for security and for IP address conversion.
- When settings of remote extensions being used at remote sites are changed at the KX-NS300 at the main site, the reflection of the changes to the remote extension may require some time due to data transfer protocols.

## Programming the KX-NS300

Follow the procedures below to configure remote port settings using Web Maintenance Console.

### Note

For the procedures below, program WAN side IP information of the router at the main site. This information is sent to KX-UT series SIP phones at the remote site after completing all programming.

### For Site Property Settings

1. Click **Setup** → **PBX Configuration** → **Configuration** → **Slot**.
2. Move the mouse pointer over **System Property**.  
A menu will be shown under the mouse pointer.
3. Click **Site**.
4. Click the **SIP Extension** tab.
5. Click **Advanced Setting for Remote SIP-MLT**.  
Program the WAN side IP information in **Setting parameters assigned to Remote SIP-MLT**.

- a. Program the following common settings.  
Configure the following items in **Setting parameters assigned to Remote SIP-MLT**.

WAN Side IP information of the router at the main site	Web Maintenance Console Parameter
CWMP	
IP Address	<b>NAT - CWMP Server IP Address</b>
SIP	
IP Address	<b>NAT - SIP Proxy Server IP Address</b>
Port Number	<b>NAT - SIP Proxy Server Port No.</b>
NTP	
IP Address	<b>NAT - NTP Server IP Address</b>
Port Number	<b>NAT - NTP Server Port No.</b>

- b. Programme the following settings according to the protocol used by KX-UT series SIP phones in the remote site.

**When the KX-UT series SIP phones are using HTTPS**

WAN Side IP information of the router at the main site	Web Maintenance Console Parameter
CWMP	
Port Number	<b>NAT - CWMP Server (HTTPS) Port No.</b>
For Data Download	
Port Number	<b>NAT - SIP-MLT Data Download Server (HTTPS) Port No.</b>

**When the KX-UT series SIP phones are using HTTP**

WAN Side IP information of the router at the main site	Web Maintenance Console Parameter
CWMP	
Port Number	<b>NAT - CWMP Server (HTTP) Port No.</b>
For Data Download	
Port Number	<b>NAT - SIP-MLT Data Download Server (HTTP) Port No.</b>

### 5.8.3 Installing SIP Phones at a Remote Site

---

6. Click **OK**.
7. Click **Setup** → **PBX Configuration** → **Configuration** → **Slot**.
8. Move the mouse pointer over **System Property**.  
A menu will be shown under the mouse pointer.
9. Click **Site**.
10. Click **Port Number** tab.
11. Programme the following items according to the protocol used by KX-UT series SIP phones in the remote site.
  - a. When the KX-UT series SIP phones are using HTTPS:
    - **CWMP (HTTPS) Port No. for SIP-MLT**
    - **Data Transmission Protocol (HTTPS) Port No. for SIP-MLT**
  - b. When the KX-UT series SIP phones are using HTTP:
    - **CWMP (HTTP) Port No. for SIP-MLT**
    - **Data Transmission Protocol (HTTP) Port No. for SIP-MLT**

#### **Note**

For the default port numbers of the KX-NS300, refer to "8.5 Port Security".

12. Click **OK**.
13. Make a backup of the data that includes the above settings.  
Click **Setup** → **System Control** → **System Reset** → **Backup**.

#### **Using a KX-NS300 as an NTP server**

When the KX-NS300 will be used as a NTP server, follow the procedures below.

1. Click **Setup** → **Network Service** → **Server Feature** → **NTP**.
2. Select **Enable**.
3. Click **OK**.

## **Programming the SBC**

The following items need to be configured on the SBC. For information about configuring the SBC, refer to the documentation of the SBC.

- IP address of the KX-NS300
- Port numbers of the KX-UT series SIP phones installed in the remote site
- IP address and subnet mask of the SBC
- LAN side IP address of the router at the main site
- WAN side IP address of the router at the main site
- SIP receiving port settings (For details, refer to the documentation of your SBC)

#### **Note**

For SIP receiving port of the SBC, specify the same port number that is specified at **NAT - SIP Proxy Server Port No.** in step 5 in "Programming the KX-NS300" in this section.

- RTP Start Port (UDP) and RTP End Port (UDP)

#### **Note**

Make sure the RTP Start Port (UDP) and RTP End Port (UDP) specified for the SBC above are in the range of the RTP port numbers that KX-NS300 uses.

For range of RTP port number of KX-NS300, refer to "Port Numbers for Optional DSP Card" in "8.5 Port Security".

- Firewall settings to allow SIP packets and RTP packets

## Programming the router at the main site

### Port forwarding settings (Router – SBC)

Configure the following items for port forwarding in between the SBC and the router.

Application	LAN Side Port Number	WAN Side Port Number
SIP Proxy	NAT-SIP Proxy Port No. (Use the same value as <b>NAT - SIP Proxy Server Port No.</b> in step 5 of "Programming the KX-NS300".)	NAT-SIP Proxy Port No. (Use the same value as <b>NAT - SIP Proxy Server Port No.</b> in step 5 of "Programming the KX-NS300".)
RTP (UDP)	Start/End RTP (UDP) Port No. (Use port numbers that are in the range of the RTP ports that the KX-NS300 uses.)	Start/End RTP (UDP) Port No. (Use port numbers that are in the range of the RTP ports that the KX-NS300 uses.)
	Make sure the RTP Start Port (UDP) and the RTP End Port (UDP) specified for the router are in the range of the RTP ports that the KX-NS300 uses. For the range of RTP port numbers that the KX-NS300 uses, refer to "Port Numbers for Optional DSP Card" in "8.5 Port Security".	

#### Note

For information about configuring port forwarding on the router, refer to the documentation of the router.

### Port forwarding settings (Router – KX-NS300)

Configure the following items for port forwarding between the KX-NS300 and the router.

Application	LAN Side Port Number	WAN Side Port Number
CWMP		
HTTP	<b>CWMP (HTTP) Port No. for SIP-MLT</b> (Use the same value as in step 11 of "Programming the KX-NS300".)	<b>NAT - CWMP Server (HTTP) Port No.</b> (Use the same value as in step 5 of "Programming the KX-NS300".)
HTTPS	<b>CWMP (HTTPS) Port No. for SIP-MLT</b> (Use the same value as in step 11 of "Programming the KX-NS300".)	<b>NAT - CWMP Server (HTTPS) Port No.</b> (Use the same value as in step 5 of "Programming the KX-NS300".)
SIP-MLT Data		
HTTP	<b>Data Transmission Protocol (HTTP) Port No. for SIP-MLT</b> (Use the same value as in step 11 of "Programming the KX-NS300".)	<b>NAT - SIP-MLT Data Download Server (HTTP) Port No.</b> (Use the same value as in step 5 of "Programming the KX-NS300".)
HTTPS	<b>Data Transmission Protocol (HTTPS) Port No. for SIP-MLT</b> (Use the same value as in step 11 of "Programming the KX-NS300".)	<b>NAT - SIP-MLT Data Download Server (HTTPS) Port No.</b> (Use the same value as in step 5 of "Programming the KX-NS300".)

### 5.8.3 Installing SIP Phones at a Remote Site

Application	LAN Side Port Number	WAN Side Port Number
NTP	123 <sup>*1</sup>	<b>NAT - NTP Server Port No.</b> (Use the same value as in step 5 of "Programming the KX-NS300".)

\*1 The port number for NTP that the KX-NS300 uses is fixed to 123.

#### Note

For information about configuring port forwarding on the router, refer to the documentation of the router.

## Installing KX-UT series SIP phones at a remote site

There are 2 methods to install KX-UT series SIP phones at a remote site:

- Set up KX-UT series SIP phones at the main site using the KX-NS300, and then send them to the remote site.
- Set up KX-UT series SIP phones without connecting them to the KX-NS300 at the main site, and then send them to the remote site.

### Setting up KX-UT series SIP phones at the main site, and then sending them to remote site

1. Register the KX-UT series SIP phone. For details, refer to "5.8.1 Registering IP Telephones".
2. Program the settings for the KX-UT series SIP phones.
  - a. Click **Setup** → **PBX Configuration** → **Configuration** → **Slot**.
  - b. Place the mouse cursor over the **Virtual Slot**, and in the menu that appears, click **Select Shelf**.
  - c. Move the mouse pointer over the V-UTEXT8 card (Virtual UT Extension Card).  
A menu will be shown under the mouse pointer.
  - d. Click **Port Property**.
  - e. Click **Remote Place** tab.
  - f. Configure the items shown below.
    - Select a protocol (HTTP/HTTPS) for **Protocol for Remote SIP-MLT**.

#### Note

When a SIP phone at remote site uses the internet to communicate with a KX-NS300, use the HTTPS protocol for security. If the connection is on VPN and protected, you may use the HTTP protocol.

- Change the value to **Remote (SBC)** for **Phone Location**.
- g. Click **OK**.
3. Unplug the AC adaptor of the KX-UT series SIP phone, and then plug it in again to reboot the KX-UT series SIP phone manually.  
The KX-UT series SIP phone will download settings automatically.

#### Note

- After downloading the setting information for the remote site, the KX-UT series SIP phone will not connect to the KX-NS300 if it is connected to the LAN at the main site. After some time, the KX-UT series SIP phone will display "9002: Connection Failed".
  - Depending on the settings of your router, the KX-UT series SIP phone may connect to the PBX. In such cases, proceed to step 4.
4. Send the KX-UT series SIP phone to the remote site and connect it to the LAN in the remote site.

#### Note

The KX-UT series SIP phone is already registered to the KX-NS300 and programmed with the remote site configuration. There is no operation required for the KX-UT series SIP phone at the remote site.

### Setting up KX-UT series SIP phones without connecting to the KX-NS300 at the main site, and then sending them to the remote site

1. Log in to the Web Maintenance Console of the site where the SIP phones will be registered.
2. Click **Utility** → **File** → **File Transfer PBX to PC**.
3. Select the config file according to the protocol used and then download it to your PC.
  - HTTP is used
    - UT\_ACS\_xyyyy.cfg
  - HTTPS is used
    - UT\_ACS\_HTTPS\_xyyyyy.cfg

For more details about downloading files from a PBX to a PC, refer to "7.2.2 Utility—File—File Transfer PBX to PC" in the PC Programming Manual.

#### Note

xx: Site ID (2 digits)

yyyy: Site name<sup>1</sup> (Up to 32 characters<sup>2</sup>)

<sup>1</sup> Spaces as well as the following characters in site names will be replaced with underscores.

/, :, \*, ?, ", <, >, | (vertical bar), &, +

<sup>2</sup> In some cases, the full site name may not be included in the file name even if it is less than 32 characters.

4. Download the config file to the KX-UT series SIP phone via the Web user interface of the KX-UT series SIP phone.  
For details, refer to "When the SIP Phones are in a different LAN (Remote site installation)" in "5.7.1 Assigning IP Addressing Information".
5. Connect the KX-UT series SIP phone to the LAN at the remote site.
6. Register the KX-UT series SIP phone to the KX-NS300 as a remote extension.
  - a. Click **Setup** → **PBX Configuration** → **Configuration** → **Slot**.
  - b. Move the mouse pointer over the V-UTEXT8 card (Virtual UT Extension Card).  
A menu will be shown under the mouse pointer.
  - c. Click **Port Property**.
  - d. Click **Remote Place** tab.
  - e. Configure the items shown below.
    - Change the value to **Remote (SBC)** for **Phone Location**.
    - Change the value to **Enable** for **Web-MC Ability**.
    - Select a protocol (HTTP/HTTPS) for **Protocol for Remote SIP-MLT**.

#### Note

Select the same value as you selected for **NAT - SIP Proxy Server Port No.** in step 5 of "Programming the KX-NS300" in this section.

- f. Click **OK**.
7. Register the KX-UT series SIP phone. For details, refer to "5.8.1 Registering IP Telephones".

#### Note

- You can select **HTTPS** for **Protocol for Remote SIP-MLT** only when **Phone Location** is set as **Remote (SBC)**.
- If the KX-UT series SIP phones don't work normally, confirm if the KX-UT series SIP phones are able to access to internet.

## 5.8.4 Installing IP Phones at a Remote Site with a Built-in Media Relay Gateway

The KX-NS300 contains a built-in Media Relay Gateway. You can install and register IP-PTs (KX-NT500 series), KX-UT series SIP phones and third party SIP phones at a remote site without adding an SBC (Session Border Controller). Also, you do not need to configure special network settings (NAT traversal, etc.) at the remote site.

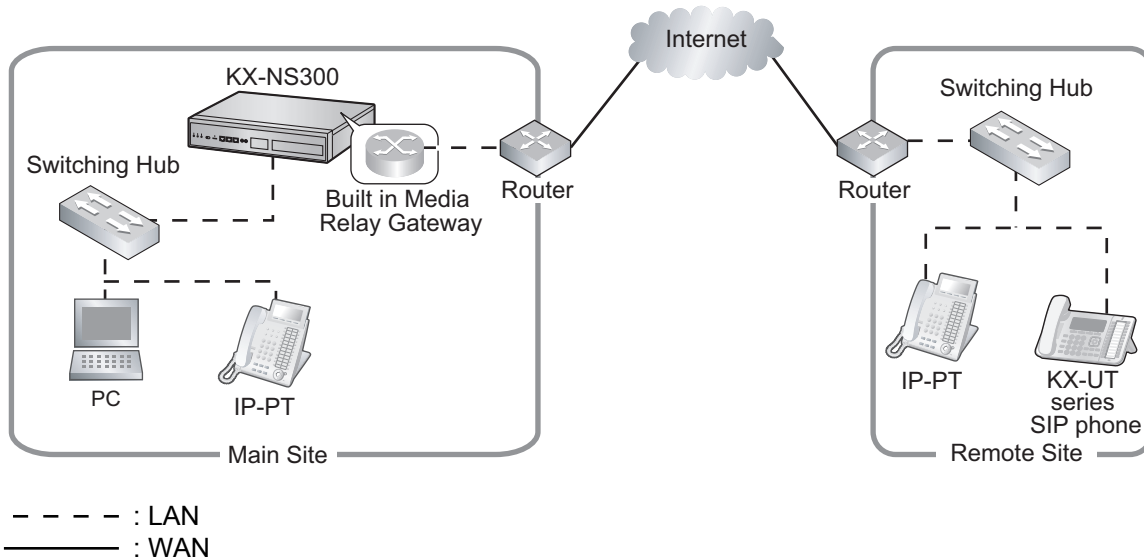

### Note

- This feature does not require an activation key.
- There is no limit to the number of terminals that can use the Media Relay Gateway feature. However, there are some conditions, as follows:
  - Peer-to-peer communication is not supported for the built-in Media Relay Gateway.
  - The number of terminals using TR-069 (CWMP)-based HTTPS is limited.
- For information about which telephone models support the built-in Media Relay Gateway, consult your dealer.

### Programming the KX-NS300 with Built-in Media Relay Gateway

Follow the procedures below to configure remote port settings using Web Maintenance Console.

### Note

For the procedures below, program WAN side IP information of the router at the main site. This information is sent to KX-NS300 series or KX-UT series SIP phones in the remote site after completing all programming.

## For Site Property Settings

1. Click **Setup** → **PBX Configuration** → **Configuration** → **Slot**.
2. Move the mouse pointer over **System Property**.  
A menu will be shown under the mouse pointer.
3. Click **Site**.
4. Click the **Media Relay** tab.



5. Programme the WAN side information in **Media Relay** tab.
- a. Programme the following common settings in **Common**.

WAN Side IP information of the router at the main site	Web Maintenance Console Parameter
IP Address	NAT - External IP Address <sup>*1</sup>

<sup>\*1</sup> You can also programme individual items of the **NAT - External IP Address**. For more details, see step e.

- b. Programme the following settings according to the protocol used by the KX-NT500 series IP extensions in the remote site. Configure the following items in **IP Extension**.

WAN Side IP information of the router at the main site	Web Maintenance Console Parameter
MGCP	
Port Number	NAT - MGCP Server Port No.

- c. Programme the following settings according to the protocol used by the KX-UT series IP extensions and SIP extensions in the remote site. Configure the following items in **SIP Extension / UT Extension**.

WAN Side IP information of the router at the main site	Web Maintenance Console Parameter
SIP	
Port Number	NAT - SIP Proxy Server Port No.

- d. Programme the following settings according to the protocol used by the KX-UT series IP extensions in the remote site. Configure the following items in **UT Extension**.

- When the KX-UT series SIP phones are using HTTPS:

WAN Side IP information of the router at the main site	Web Maintenance Console Parameter
CWMP	
Port Number	NAT - CWMP Server (HTTPS) Port No.
Port Number	NAT - CWMP Server (HTTPS) Port No. for Network Survivability
For Data Download	
Port Number	NAT - SIP-MLT Data Download Server (HTTPS) Port No.

- When the KX-UT series SIP phones are using HTTP:

WAN Side IP information of the router at the main site	Web Maintenance Console Parameter
CWMP	

5.8.4 Installing IP Phones at a Remote Site with a Built-in Media Relay Gateway

WAN Side IP information of the router at the main site	Web Maintenance Console Parameter
Port Number	NAT - CWMP Server (HTTP) Port No.
Port Number	NAT - CWMP Server (HTTP) Port No. for Network Survivability
For Data Download	
Port Number	NAT - SIP-MLT Data Download Server (HTTP) Port No.

e. Programme the following common settings in **Option**.

WAN Side IP information of the router at the main site	Web Maintenance Console Parameter
RTP	
IP Address	NAT - RTP IP Address
SIP	
IP Address	NAT - SIP Proxy Server IP Address
CWMP	
IP Address	NAT - CWMP Server IP Address
IP Address	NAT - CWMP Server IP Address for Network Survivability
NTP	
IP Address	NAT - NTP Server IP Address

If necessary, you can program the individual settings here and overwrite the **NAT - External IP Address** setting programmed in step a.

6. Click **OK**.
7. Click **Setup** → **PBX Configuration** → **Configuration** → **Slot**.
8. Move the mouse pointer over **System Property**.  
A menu will be shown under the mouse pointer.
9. Click **Site**.
10. Click the **Port Number** tab.
11. Programme the following items according to the protocol used by KX-UT series SIP phones in the remote site.
  - a. When the KX-UT series SIP phones are using HTTPS:
    - **CWMP (HTTPS) Port No. for SIP-MLT**
    - **Data Transmission Protocol (HTTPS) Port No. for SIP-MLT**

- b. When the KX-UT series SIP phones are using HTTP:
- **CWMP (HTTP) Port No. for SIP-MLT**
  - **Data Transmission Protocol (HTTP) Port No. for SIP-MLT**

**Note**

For the default port numbers of the KX-NS300, refer to "8.5 Port Security".

12. Click **OK**.

**Using a KX-NS300 as an NTP server**

When the KX-NS300 will be used as a NTP server, follow the procedures below.

1. Click **Setup** → **Network Service** → **Server Feature** → **NTP**.
2. Select **Enable**.
3. Click **OK**.

**Programming the router at the main site with Built-in Media Relay Gateway****Port forwarding settings (Router – KX-NS300)**

Configure the following items for port forwarding between the Media Relay Gateway and the router.

For the KX-NT500 series:

Application	LAN Side Port Number	WAN Side Port Number
PTAP	<b>Signalling (PTAP) UDP Port No. (Server)</b> (refer to PC Programming Guide "9.15 PBX Configuration—[1-1] Configuration—Slot—V-SIPEXT—Card Property")	<b>Signalling (PTAP) UDP Port No. (Server)</b> (refer to PC Programming Guide "9.15 PBX Configuration—[1-1] Configuration—Slot—V-SIPEXT—Card Property")
MGCP	<b>Signalling (MGCP) UDP Port No. (Server)</b> (refer to PC Programming Guide "9.15 PBX Configuration—[1-1] Configuration—Slot—V-SIPEXT—Card Property")	<b>NAT - MGCP Server Port No.</b> (Use the same value as in step 5 of "Programming the KX-NS300 with Built-in Media Relay Gateway".)
RTP (UDP)	Start/End RTP (UDP) Port No. (Use port numbers that are in the range of the RTP ports that the KX-NS300 uses.) <sup>1</sup>	Start/End RTP (UDP) Port No. (Use port numbers that are in the range of the RTP ports that the KX-NS300 uses.) <sup>1</sup>
	Make sure the RTP Start Port (UDP) and the RTP End Port (UDP) specified for the router are in the range of the RTP ports that the KX-NS300 uses. For the range of RTP port numbers that the KX-NS300 uses, refer to "Port Numbers for Optional DSP Card" in "8.5 Port Security". <sup>1</sup>	

<sup>1</sup> The port number ranges must be within the range of RTP/RTCP for NAT traversal (16000–18047). IP address can be assigned to the KX-NS300's optional DSP cards. The following example shows the port number ranges set for each IP address:

#### 5.8.4 Installing IP Phones at a Remote Site with a Built-in Media Relay Gateway

For the KX-UT series:

Application	LAN Side Port Number	WAN Side Port Number
SIP Proxy	<b>UDP Port No. for SIP Extension Server</b> (refer to PC Programming Guide "9.2.2 PBX Configuration—[1-1] Configuration—Slot—System Property—Site—Port Number")	NAT-SIP Proxy Port No. (Use the same value as <b>NAT - SIP Proxy Server Port No.</b> in step 5 of "Programming the KX-NS300 with Built-in Media Relay Gateway")
CWMP		
HTTP	<b>CWMP (HTTP) Port No. for SIP-MLT</b> (Use the same value as in step 11 of "Programming the KX-NS300 with Built-in Media Relay Gateway".)	<b>NAT - CWMP Server (HTTP) Port No.</b> (Use the same value as in step 5 of "Programming the KX-NS300 with Built-in Media Relay Gateway".)
HTTPS	<b>CWMP (HTTPS) Port No. for SIP-MLT</b> (Use the same value as in step 11 of "Programming the KX-NS300 with Built-in Media Relay Gateway".)	<b>NAT - CWMP Server (HTTPS) Port No.</b> (Use the same value as in step 5 of "Programming the KX-NS300 with Built-in Media Relay Gateway".)
SIP-MLT Data		
HTTP	<b>Data Transmission Protocol (HTTP) Port No. for SIP-MLT</b> (Use the same value as in step 11 of "Programming the KX-NS300 with Built-in Media Relay Gateway".)	<b>NAT - SIP-MLT Data Download Server (HTTP) Port No.</b> (Use the same value as in step 5 of "Programming the KX-NS300 with Built-in Media Relay Gateway".)
HTTPS	<b>Data Transmission Protocol (HTTPS) Port No. for SIP-MLT</b> (Use the same value as in step 11 of "Programming the KX-NS300 with Built-in Media Relay Gateway".)	<b>NAT - SIP-MLT Data Download Server (HTTPS) Port No.</b> (Use the same value as in step 5 of "Programming the KX-NS300 with Built-in Media Relay Gateway".)
NTP	123 <sup>1</sup>	<b>NAT - NTP Server Port No.</b> (Use the same value as in step 5 of "Programming the KX-NS300 with Built-in Media Relay Gateway".)

Application	LAN Side Port Number	WAN Side Port Number
RTP (UDP)	Start/End RTP (UDP) Port No. (Use port numbers that are in the range of the RTP ports that the KX-NS300 uses.) <sup>1</sup>	Start/End RTP (UDP) Port No. (Use port numbers that are in the range of the RTP ports that the KX-NS300 uses.) <sup>1</sup>
	Make sure the RTP Start Port (UDP) and the RTP End Port (UDP) specified for the router are in the range of the RTP ports that the KX-NS300 uses. For the range of RTP port numbers that the KX-NS300 uses, refer to "Port Numbers for Optional DSP Card" in "8.5 Port Security". <sup>1</sup>	

<sup>1</sup> The port number for NTP that the KX-NS300 uses is fixed to 123.

<sup>2</sup> The port number ranges must be within the range of RTP/RTCP for NAT traversal (16000–18047). IP address can be assigned to the KX-NS300's optional DSP cards. The following example shows the port number ranges set for each IP address:

## Installing KX-NT500 series IP-PTs at a remote site with Built-in Media Relay Gateway

You can install KX-NT500 series IP-PTs at the remote site directly or from the local site as follows.

1. Register the IP-PT. For details, refer to "5.8.1 Registering IP Telephones".
2. Programme the settings for the IP-PT.
  - a. Click **Setup** → **PBX Configuration** → **Configuration** → **Slot**.
  - b. Click **Virtual** → **V-IPEXT8**.
  - c. Move the mouse pointer over the V-IPEXT8 card (Virtual IP Extension Card). A menu will be shown under the mouse pointer.
  - d. Click **Port Property**.
  - e. Click the **Remote Place** tab.
  - f. Configure the items shown below.
    - Change the value to **Remote (MRG)** for **Phone Location**.
  - g. Click **OK**.
3. Unplug the AC adaptor of the IP-PT, and then plug it in again to reboot the IP-PT manually. The IP-PT will download settings automatically.

## Installing KX-UT series SIP phones at a remote site with Built-in Media Relay Gateway

There are 2 methods to install KX-UT series SIP phones at a remote site:

- Set up the phones at the main site using the KX-NS300, and then send them to the remote site.
- Set up the phones without connecting them to the KX-NS300 at the main site, and then send them to the remote site.

### Setting up KX-UT series SIP phones at the main site, and then sending them to remote site

1. Register the phone. For details, refer to "5.8.1 Registering IP Telephones".
2. Programme the settings for the phone.
  - a. Click **Setup** → **PBX Configuration** → **Configuration** → **Slot**.
  - b. Click **Virtual** → **V-UTEXT8**.
  - c. Move the mouse pointer over the V-UTEXT8 card (Virtual UT Extension Card). A menu will be shown under the mouse pointer.
  - d. Click **Port Property**.
  - e. Click the **Remote Place** tab.

## 5.8.4 Installing IP Phones at a Remote Site with a Built-in Media Relay Gateway

- f. Configure the items shown below.
  - Change the value to **Remote (MRG)** for **Phone Location**.
  - Select a protocol (HTTP/HTTPS) for **Protocol for Remote SIP-MLT**.

### **Note**

When a SIP phone at a remote site uses the internet to communicate with a KX-NS300, use the HTTPS protocol for security. If the connection is on a VPN and is protected, you may use the HTTP protocol.

- g. Click **OK**.
3. Unplug the AC adaptor of the phone, and then plug it in again to reboot the phone manually. The phone will download settings automatically.

### **Note**

- After downloading the setting information for the remote site, the KX-UT series SIP phone will not connect to the KX-NS300 if it is connected to the LAN at the main site. After some time, the KX-UT series SIP phone will display "9002: Connection Failed".
- Depending on the settings of your router, the KX-UT series SIP phone may connect to the PBX. In this case, proceed to step 4.

4. Send the KX-UT series SIP phone to the remote site and connect it to the LAN in the remote site.

### **Note**

The KX-UT series SIP phone is already registered to the KX-NS300 and programmed with the remote site configuration. No operation is required for the KX-UT series SIP phone in the remote site.

## Setting up KX-UT series SIP phones without connecting to the KX-NS300 at the main site, and then sending them to the remote site

1. Log in to Web Maintenance Console of the site where the SIP phones will be registered.
2. Click **Utility** → **File** → **File Transfer PBX to PC**.
3. Select the config file according to the protocol used and then download it to your PC.
  - If HTTPS is used:
    - UT\_MRG\_HTTPS\_xxyyyy.cfg

For more details about downloading files from a PBX to a PC, refer to "7.2.2 Utility—File—File Transfer PBX to PC" in the PC Programming Manual.

### **Note**

xx: Site ID (2 digits)

yyyy: Site name<sup>1</sup> (Up to 32 characters<sup>2</sup>)

<sup>1</sup> Spaces as well as the following characters in site names will be replaced with underscores.

/, :, \*, ?, ", <, >, | (vertical bar), &, +

<sup>2</sup> In some cases, the full site name may not be included in the file name even if it is less than 32 characters.

4. Download the config file to the KX-UT series SIP phone via the Web user interface of the KX-UT series SIP phone. For details, refer to "When the SIP Phones are in a different LAN (Remote site installation)" in "5.7.1 Assigning IP Addressing Information".
5. Connect the KX-UT series SIP phone to the LAN in the remote site.
6. Register the KX-UT series SIP phone to the KX-NS300 as a remote extension.
  - a. Click **Setup** → **PBX Configuration** → **Configuration** → **Slot**.
  - b. Click **Virtual** → **V-UTEXT8**.
  - c. Move the mouse pointer over the V-UTEXT8 card (Virtual UT Extension Card).  
A menu will be shown under the mouse pointer.
  - d. Click **Port Property**.
  - e. Click the **Remote Place** tab.
  - f. Configure the items shown below.

- Change the value to **Remote (MRG)** for **Phone Location**.
- Change the value **Enable** for **Web-MC Ability**.
- Select a protocol (HTTP/HTTPS) for **Protocol for Remote SIP-MLT**.

**Note**

Select the same value as you selected for **NAT - SIP Proxy Server Port No.** in step 5 of "Programming the KX-NS300 with Built-in Media Relay Gateway" in this section.

**g.** Click **OK**.

**7.** Register the KX-UT series SIP phone. For details, refer to "5.8.1 Registering IP Telephones".

**Note**

- You can select **HTTPS** for **Protocol for Remote SIP-MLT** only when **Phone Location** is set as **Remote (MRG)**.
- If the KX-UT series SIP phone does not work normally, confirm whether the KX-UT series SIP phone can access the internet.

# 5.9 Configuration of Users

The system manages information about each user.

Before programming other user settings, the following information must be configured for each user:

- Extension number
- Name
- Unified Messaging mailbox
- Web Maintenance Console login account (ID and password)

Follow the procedure below to efficiently programme basic personal information by adding multiple users with the Add Range feature.

**1. Click Setup → PBX Configuration → Configuration → Slot.**

Add one or more extension cards to the system, according to your equipment and needs. Extension numbers will be automatically created for each extension card that is added. For details about adding extension cards, refer to "9.1 PBX Configuration—[1-1] Configuration—Slot" in the PC Programming Manual.

**2. Click Setup → PBX Configuration → Extension.**

Enter an extension name for each extension number to be used. For details, refer to the following sections in the PC Programming Manual:

- 12.1.1 PBX Configuration—[4-1-1] Extension—Wired Extension—Extension Settings
- 12.2.1 PBX Configuration—[4-2-1] Extension—Portable Station—Extension Settings

**Note**

You also can import extension names from a CSV file. For details refer to "6.5 Tool—Import" in the PC Programming Manual.

**3. Click Setup → Users → User Profiles.**

Select **Rule of copy to extension name** on the **Option** tab.

- **Rule-A: [First Name] [space] [Last Name]**
- **Rule-B: [Last Name] [,] [First Name]**

**4. Click Setup → Users → User Profiles.**

You can create multiple user profiles automatically by using the Add Range feature for extension numbers. You can also set an extension number, first name, last name, Unified Messaging mailbox, and Web Maintenance Console login account for each user manually.

For details, refer to "User Controls" in "8.1 Users—User Profiles" in the PC Programming Manual.

For each user profile added using the Add Range feature, the following information is automatically assigned:

- **First Name/Last Name**

**Extension Name**, which is the name displayed on extension LCDs, can be copied all at once to the **First Name** and **Last Name** settings for each extension.

The format you selected in **Rule of copy to extension name** in step 3 determines how these are copied.

- Case 1: You selected Rule-A, and the format of the name is assumed to be "[**First Name**] (space) [**Last Name**]".
- Case 2: You selected Rule-B, and the format of the name is assumed to be "[**Last Name**], [**First Name**]".
- Case 3: **Extension Name** is set to not follow **Rule of copy to extension name**:

**Example of copying Rule of copy to extension name**

	Extension Name	User Profile	
		First Name	Last Name
Case 1	Tarou Yamada	Tarou	Yamada



	Extension Name	User Profile	
		First Name	Last Name
Case 2	Yamada,Tarou	Tarou	Yamada
Case 3	TarouYamada	Ext. 101	TarouYamada

- **Login ID:** The extension number (i.e., if the extension is "101", the Login ID for the user will also be "101")
  - **Password:** "PWD" + the extension number for the user (e.g., "PWD101")
5. If additional editing is required for users, settings can be configured on the following screens:
- a. To edit user information: **Setup** → **Users** → **User Profiles**
  - b. To edit extension settings: **Setup** → **PBX Configuration** → **Extension**
  - c. To edit mailbox settings: **Setup** → **UM Configuration** → **Mailbox Settings**

#### Note

- You also can create mailboxes for Incoming Call Distribution Groups on the **Mailbox Settings** screen.
- Since the Built-in Unified Messaging System is part of this PBX, the settings of the following items are shared between the PBX and Unified Messaging system.
  - a. Date and time, and enable/disable settings in Holiday Table  
The following 2 items are shared. For details, refer to the PC Programming Manual.
    - 10.5 PBX Configuration—[2-5] System—Holiday Table
    - 23.4 UM Configuration—[4-4] Service Settings—Holiday Table
  - b. Mailboxes with the same mailbox number as their associated extension numbers  
When the same mailbox number is used as the extension number, it is possible to select whether the system keeps the two synchronised (i.e., one changes when the other does). For details about the setting, refer to "10.9 PBX Configuration—[2-9] System—System Options—Option 9" in the PC Programming Manual.  
For instance, when an extension number is changed, the mailbox number of the mailbox assigned to that extension changes to match the new extension number. However, if a mailbox with the same number already exists, the mailbox number will not change.
  - c. Mailbox COS  
When assigning COS levels to user profiles (either extension or mailbox), by default the extension COS and mailbox COS are set to the same level. You can specify whether these values are synchronised by the system.  
For details, refer to "10.9 PBX Configuration—[2-9] System—System Options—Option 9" in the PC Programming Manual.  
If enabled, when one COS setting is changed, the other will change to match the new setting. (When this setting is first enabled, the extension COS setting is used as the mailbox COS.)
  - d. Since the outside line access number and trunk call (transfer) procedures are synchronised in the PBX settings, each outside line access number (e.g., idle line access, trunk group access, specified line access) are available for features that make calls (e.g., External Message Delivery). These features will first recognise the outside line access number part of a number, and then perform dial tone detection, etc.

## 5.10 Programming E-mail Integration for UM Voice

Users with Unified Messaging (UM) mailboxes (referred to below as "subscribers") can receive their voice as data using the following methods:

- Receiving attachments to a POP3 e-mail account
- Accessing data through an IMAP4 e-mail account

### Note

KX-NSU201, KX-NSU205, KX-NSU210, KX-NSU220, or KX-NSU299 (Activation Key for Unified Messaging E-mail Notification) is required to enable this feature for users.

For details about these activation keys, see "Unified Messaging System (Mailbox)" in "3.1.1 Type and Maximum Number of Activation Keys".

### Receiving Attachments to a POP3 E-mail Account

An e-mail can be sent to Unified Message system subscribers, notifying them of a new voice. Subscribers can also choose to have the voice message attached to the notification, as well as choose to have the message deleted from the system after it has been sent.

1. Specify SMTP server settings.
  - a. Click **Setup** → **Network Service** → **Server Feature** → **SMTP**.
  - b. Specify the name to be used for the e-mail messages that will be sent from the system in **Mail sending—Mail sender information name**.
  - c. Specify the e-mail address for the e-mail messages that will be sent from the system in **Mail sending—Mail Address**.
  - d. Specify the IP address or host name of the SMTP server to use in **SMTP server for relay—SMTP server address**.
  - e. Specify the port number of the SMTP server to use in **SMTP server for relay—SMTP server Port number**.
  - f. Specify the following parameters if required.
    - **SMTP over TLS**
    - **SMTP Authentication**
    - **POP before SMTP**
    - **Receive Port number (SMTP)**
    - **Receive Port number (SMTPs)**

### Note

For details about these parameters, refer to "27.2.5 Network Service—[2-6] Server Feature—SMTP" in the PC Programming Manual.

- g. Click **OK**.
2. Specify e-mail options.
  - a. Click **Setup** → **UM Configuration** → **System Parameters** → **Parameters** → **E-mail Option**.
  - b. Specify the following parameters.
    - **Mail Address (Up to 128 ASCII characters)**
    - **Full Name (Up to 64 ASCII characters)**
    - **Maximum Message Length (Selection)**
    - **Maximum Message Length (Other) (1-30 min)**
  - c. Click **OK**.
3. Enable e-mail notification.
  - a. Click **Setup** → **UM Configuration** → **Class of Service** → **General**.
  - b. In **E-mail Option**, select **Yes** for all Class of Service members that will receive e-mail notifications.
  - c. Click **OK**.

4. Specify notification parameters.
  - a. Click **Setup** → **UM Configuration** → **Mailbox Settings** → **Notification Parameters**.
  - b. Click **Edit** in **E-mail/Text Message Device**.
  - c. Specify the following parameters for **Device No. 1, 2, and 3** as required.
    - **User name**
    - **E-mail Address**
    - **Only Urgent Messages**
    - **Title Order**
    - **Title String**
    - **Call-back Number [0-9, \*, #]**
    - **Send Wait Time [0-120 min]**
    - **Attach Voice File**
    - **Use Mode**

**Note**

For details about these parameters, refer to "20.1 UM Configuration—[1] Mailbox Settings—Notification Parameters" in the PC Programming Manual.

- d. Click **OK**.

## Accessing Data Through an IMAP4 E-mail Account

### Downloading the IMAP Session Controller Software

When more than 24 users will be accessing data through IMAP4 e-mail accounts, each user must use the IMAP Session Controller software.

The IMAP Session Controller software can be downloaded from Web Maintenance Console:

1. Log in with a User level account.  
The **Edit User** screen is displayed.
2. Click the **Unified Message** tab.
3. Click **Download** for **Unified Messaging Plug in** to access the download site for the IMAP Session Controller software.

**Note**

For details about installing and setting up the IMAP Session Controller software, refer to the User Manual.

### Configuring IMAP Accounts

By configuring an IMAP account, subscribers can access the contents of their UM mailboxes through an e-mail client. All that is necessary is an e-mail client that supports IMAP4.

Once IMAP integration is programmed, users can do the following:

- Listen to voice messages
  - Save voice data to their PCs
  - Delete voice stored on the PBX
1. Enable IMAP integration.
    - a. Click **Setup** → **UM Configuration** → **Class of Service** → **General**.
    - b. In **Desktop Messaging**, select **Yes** for all Class of Service members that will use IMAP integration.
    - c. Click **OK**.
  2. Specify the mailbox password.
    - a. Click **Setup** → **UM Configuration** → **Mailbox Settings** → **Mailbox Parameters**.
    - b. Click **Edit** in **Mailbox Password (Message Client)**.
    - c. Enter a password in **Enter new password**.
    - d. Enter the password again in **Confirm new password**.
    - e. Click **OK**.

- f. Click **OK**.
3. Specify IMAP parameters.
  - a. Click **Setup** → **Network Service** → **Server Feature** → **IMAP4**.
  - b. Specify the following parameters (if required).
    - **IMAP4 server**
    - **Port Number**
    - **IMAP4 over SSL**
    - **CAPABILITY command**
    - **Authenticated Connection Timeout**

### **Note**

For details about these parameters, refer to "27.2.6 Network Service—[2-7] Server Feature—IMAP4" in the PC Programming Manual.

- c. Click **OK**.

### **Setting Up the IMAP Account in a Subscriber's E-mail Client**

An account must be set up in each subscriber's e-mail client for use with the Unified Messaging system. The setup procedure will vary depending on the e-mail client application used and the configuration of your network. When adding the account, the settings must be specified as follows:

- The e-mail address will be the subscriber's existing e-mail address.
- The type of the account must be set to "IMAP".
- The incoming mail server must be set as the IP Address of the PBX where the subscriber's UM mailbox is located.
- The user name/ID will be the subscriber's UM Mailbox Number.
- The password will be the **Mailbox Password (Message Client)** set in step 2 above.
- A valid SMTP server must be used (i.e. the SMTP server used for existing mail accounts).

The following example setup procedure is for Microsoft Outlook® 2010. Subscribers' e-mail client setting names and locations may differ.

1. In Outlook 2010, select **File**, and then **Info**.
2. Click the **Add Account** button.
3. Select **Manually configure server settings or additional server types**.
4. Select **Internet E-mail**, and then click **Next**.
5. Configure the server settings as follows:

#### **User Information**

- In **Your Name**, enter the name of the subscriber. (In the example, "John Smith")
- In **E-mail Address**, enter the existing mail address of the subscriber. (In the example below, "j.smith@example.com")

#### **Server Information**

- Select **IMAP** for **Account type**.
- In **Incoming mail server**, enter the IP address of the PBX where the subscriber's UM mailbox is located. (In the example below, "10.178.19.206")
- In **Outgoing mail server (SMTP)**, enter the SMTP server used for the subscriber's existing mail account. (In the example below, "mail.example.com")

#### **Logon Information**

- In **User Name**, enter the subscriber's Mailbox Number. (In the example below, "407")
  - In **Password**, enter the password for the subscriber specified in Mailbox Password (Message Client).
6. Click **Next** and then complete the account settings.

## Example IMAP Account Settings (Outlook 2010)

The screenshot shows the 'Add New Account' dialog box in Outlook 2010. The window title is 'Add New Account'. The main heading is 'Internet E-mail Settings' with a sub-note: 'Each of these settings are required to get your e-mail account working.' The dialog is divided into several sections:

- User Information:** 'Your Name' is 'John Smith' and 'E-mail Address' is 'j.smith@example.com'.
- Server Information:** 'Account Type' is 'IMAP', 'Incoming mail server' is '10.178.19.206', and 'Outgoing mail server (SMTP)' is 'mail.example.com'.
- Logon Information:** 'User Name' is '407' and 'Password' is masked with '\*\*\*\*\*'. There is a checked checkbox for 'Remember password' and an unchecked checkbox for 'Require logon using Secure Password Authentication (SPA)'.
- Test Account Settings:** A text block explains that after filling out the information, the user should test the account. Below this is a 'Test Account Settings ...' button and a checked checkbox for 'Test Account Settings by clicking the Next button'.

At the bottom right, there is a 'More Settings ...' button. At the bottom center, there are three buttons: '< Back', 'Next >', and 'Cancel'.

# 5.11 Automatic Configuration of Mailboxes

Mailboxes can be automatically created and associated with an extension number if these items do not already exist. There are 2 modes for creating mailboxes. For each specified extension number, a mailbox is automatically created if one is not already associated with the extension. The results of creating and associating mailboxes and user profiles with extension numbers are output both to a file and to the syslog. If many mailboxes must be created or deleted, the amount of time required to complete the task is displayed on the screen.

## Creating mailboxes for all extensions

### Note

If a mailbox does not satisfy the conditions for automatic creation, neither will be created for the corresponding extension.

1. In Web Maintenance Console, click Setup-UM Configuration-Mailbox Settings-Auto Configuration-Create all mailboxes
2. Click Execute.
  - Mailboxes are created with the same number as the extension number.
  - However, a mailbox will not be created in any of the following conditions:
    - a. A mailbox with the same number as the extension number already exists
    - b. The extension number has only 1 digit
    - c. The total number of mailboxes, including already existing mailboxes, exceeds 500

## Re-creating all mailboxes

### IMPORTANT

**This procedure deletes all existing voice data, all settings and all prompts from all mailboxes.** In this procedure, voice data (e.g., mailbox voice data, personal greetings) and settings (e.g., the password) are not deleted from the managers' mailboxes. Be sure to make a backup of any important data beforehand. If mailbox numbers are changed after mailboxes have been deleted using this feature, even if a backup of the mailbox settings, voice data (e.g., personal greetings), and messages has been made, the data cannot be restored. After executing this function, all messages will have been deleted, and it is necessary to reconfigure all mailbox settings and re-record all prompts.

1. In Web Maintenance Console, click Setup→UM Configuration→Mailbox Settings→Auto Configuration→Re-create all mailboxes
2. Select the radio button where you want the mailboxes to be created.
  - Create mailboxes to the UM group of the PBX where the extensions belong to
  - Create mailboxes to the specified UM group (UM Group No. 1 to 16)
3. Click Execute.
  - Every type of mailbox, except the manager's mailboxes, will be deleted.
  - If there are currently mailboxes in use, you can select whether to delete them forcibly or cancel the operation.
  - All mailboxes will be recreated.
  - A mailbox will not be created in the following conditions:
    - The extension number has only 1 digit

## Results of creating mailboxes

The results of creating mailboxes are recorded in a text file. Follow the procedure below to view the file.

1. When automatic configuration completes, click OK on the "Mailbox create result" dialogue box.

2. Mailbox\_result.txt is saved to the local PC.
3. The meaning of the status in the generated file is as follows:

User Profile Status	Description
Exist	The user profile already existed and was assigned to the related mailbox and extension number.
Skipped	The user profile was already assigned to the related mailbox and extension number.

Mailbox Status	Description
Created	The new mailbox was successfully created.
Failed	The new mailbox was not created.
Assigned	The mailbox already existed, but was successfully assigned to the related extension number.
Exist	The mailbox was already assigned to the related extension number.
Skipped	The mailbox already existed, but assigning it to the related extension number failed.

The start and finish times of the automatic configuration is recorded in the syslog (INFO). For details, refer to "7.3.2 Utility—Log—Syslog" in the PC Programming Manual.

## 5.11 Automatic Configuration of Mailboxes

---



---

## **Section 6**

# ***Methods of Stacking Expansion Units***

*This section provides information about stacking expansion units.*

## 6.1 Methods of Stacking Expansion Units

Stacking expansion units with the KX-NS300 allows you to expand the usage of legacy terminals and trunks. When expansion units are stacked, the KX-NS300 will control communication, as well as all IP terminals on the site.

### **Note**

For details about connecting an expansion unit to a KX-NS300, refer to the 4.6.1 EXP-M Card (KX-NS5130) in this manual.

There are 2 ways of stacking Expansion Units with the KX-NS300.

### **Case 1**

Stacking expansion units to a KX-NS300 (not running).

To stack expansion units to a KX-NS300 which is not running currently, refer to "Procedure for Case 1 and Case 2".

### **Case 2**

Stacking expansion units to a KX-NS300 (running).

To stack expansion units to a KX-NS300 which is already running, refer to "Procedure for Case 1 and Case 2".

## Stacking Procedures

The following procedures show how to stack expansion units in each case.

### **CAUTION**

- When installing or removing the optional service cards, the power switch must be turned off.
- When installing or removing the optional service cards, do not put pressure on any parts of the mother board. Doing so may result in damage to the PBX.

### **Notice**

If there is already a expansion unit stacked and connected to a EXP-M card installed in a KX-NS300, you can skip shutting down the KX-NS300 in the following procedures.

### **Note**

- For information about starting the KX-NS300 for the first time, refer to "4.13 Starting the KX-NS300".
- The Expansion Unit will be initialised when started up with a EXP-M card mounted and extension numbers will be created automatically.

### **Procedure for Case 1 and Case 2**

1. Follow the procedure below for the expansion unit.
  - a. Make sure the power switch is turned off. If the KX-NS300 is running, shutdown the KX-NS300 and then turn off the power switch.
  - b. Connect the LAN cable to EXP-S card.
2. Follow the procedure below for the KX-NS300.
  - a. Make sure the power switch is turned off.
  - b. Insert a EXP-M card into the EXP-M card slot.
  - c. Connect the LAN cable to EXP-M card.
3. Follow the procedure below for the KX-NS300 and expansion unit KX-NS320.
  - a. Turn the power switch on.

## Pre-installing stacked Expansion units connected to the EXP-M card

Once a EXP-M card has been added to the physical shelf on the **Slot** screen, you can pre-install stacked Expansion units connected to the EXP-M card.

1. Log in to Web Maintenance Console. For details, refer to "Connecting to Web Maintenance Console" in "5.3 Starting Web Maintenance Console".
2. Click **Setup** → **PBX Configuration** → **Configuration** → **Slot**.
3. Place the mouse cursor over the EXP-M card, and in the menu that appears, click **Pre-Install**.
4. Select the Expansion unit connected to connection port 1 of the EXP-M card, and then click the arrow button.
5. If a second stackable Expansion units is connected to connection port 2 of the EXP-M card, click the arrow button.
6. Click **OK** when finished to complete pre-installation.

## Programming Expansion unit

To programme Expansion units that are stacked with a KX-NS300, use Web Maintenance Console.

To log in to Web Maintenance Console, refer to "Connecting to Web Maintenance Console" in "5.3 Starting Web Maintenance Console".

For more information about programming Expansion unit, refer to the PC Programming Manual.

## 6.1 Methods of Stacking Expansion Units

---

---

# **Section 7**

## ***Troubleshooting***

*This section provides information on the PBX and telephone troubleshooting.*

## 7.1 Troubleshooting

### 7.1.1 Installation

PROBLEM	PROBABLE CAUSE	SOLUTION
You cannot make/receive calls via an IP network.	• DSP card malfunction	• Replace the corresponding card.
	• Mother board malfunction	• Replace the mother board (be sure to turn off the PBX when replacing).
	• Not enough activation keys	• Purchase additional activation key codes. Please consult a certified dealer for details.
	• Poor connection	<ul style="list-style-type: none"> <li>• Make sure that an 8-pin twisted pair cable is used for connection.</li> <li>• Make sure that none of the CAT 5/CAT 5e cables in use are over 100 m in length.</li> <li>• Make sure that a straight cable is used for connection to a switching hub.</li> </ul>
	• Network malfunction	<ul style="list-style-type: none"> <li>• Make sure that all network devices in use are switched on.</li> <li>• Make sure that there is no unwanted firewall in the IP network.</li> </ul>
IP-PTs/SIP phones do not operate.	• DSP card malfunction	• Replace the corresponding card.
	• Mother board malfunction	• Replace the mother board (be sure to turn off the PBX when replacing).
	• Not enough activation keys	• Purchase additional activation key codes. Please consult a certified dealer for details.
	• IP-PT/SIP phone not registered	• Register the corresponding IP-PT/SIP phone.
	• IP-PT/SIP phone malfunction	• Replace the IP-PT/SIP phone.
	• Poor connection	<ul style="list-style-type: none"> <li>• Make sure that an 8-pin twisted pair cable is used for connection.</li> <li>• Make sure that none of the CAT 5/CAT 5e cables in use are over 100 m in length.</li> <li>• Make sure that a straight cable is used for connection to a switching hub.</li> </ul>
	• Network malfunction	<ul style="list-style-type: none"> <li>• Make sure that all network devices in use are switched on.</li> <li>• Make sure that the IP-PT/SIP phone is not blocked by the firewall or other network devices.</li> </ul>

PROBLEM	PROBABLE CAUSE	SOLUTION
Extensions (except IP-PT/SIP phone) do not operate.	<ul style="list-style-type: none"> <li>Extension card malfunction</li> </ul>	<ul style="list-style-type: none"> <li>Replace the corresponding card.</li> </ul>
	<ul style="list-style-type: none"> <li>Poor connection between the PBX and the extension</li> </ul>	<ul style="list-style-type: none"> <li>Take the extension and plug it into the same extension port using a short telephone cord. If the extension works, then the connection between the PBX and the extension must be repaired.</li> </ul>
	<ul style="list-style-type: none"> <li>A telephone with an A-A1 relay is connected.</li> </ul>	<ul style="list-style-type: none"> <li>Make sure that a 2-wire cord is used.</li> <li>Make sure that the A-A1 relay switch of the telephone is in "OUT" or "OFF" position.</li> </ul>
	<ul style="list-style-type: none"> <li>Extension malfunction</li> </ul>	<ul style="list-style-type: none"> <li>Take the extension and plug it into another extension port that is working. If the extension does not work, replace the extension.</li> </ul>
The PBX does not operate properly.		<ul style="list-style-type: none"> <li>Restart the PBX (refer to "7.1.5 Restarting the KX-NS300").</li> <li>Turn off the power switch, and then turn it back on.</li> <li>Turn off the power switch, and then unplug the PBX. After 5 minutes, plug the PBX back in, and turn the power switch back on.</li> </ul>
Noise on external paging.	<ul style="list-style-type: none"> <li>Induced noise on the wire between the PBX and the amplifier.</li> </ul>	<ul style="list-style-type: none"> <li>Use a shielded cable as the connection wire between the PBX and amplifier. A short shielded cable is recommended.</li> </ul>
Distorted external music.	<ul style="list-style-type: none"> <li>Excessive input level from external music source.</li> </ul>	<ul style="list-style-type: none"> <li>Decrease the output level of the external music source by using the volume control on the music source.</li> </ul>
The STATUS indicator on the front of the cabinet turns on red.	<ul style="list-style-type: none"> <li>A major system error occurs in the PBX.</li> </ul>	<ul style="list-style-type: none"> <li>See the error log using Web Maintenance Console (refer to "7.1.6 Troubleshooting by Error Log").</li> </ul>
The LINK indicator of the mother board does not turn on.	<ul style="list-style-type: none"> <li>Mother board malfunction</li> </ul>	<ul style="list-style-type: none"> <li>Replace the mother board (be sure to turn off the PBX when replacing).</li> </ul>
	<ul style="list-style-type: none"> <li>Poor connection.</li> </ul>	<ul style="list-style-type: none"> <li>Make sure that an 8-pin twisted pair cable is used for connection.</li> <li>Make sure that none of the CAT 5/CAT 5e cables in use are over 100 m in length.</li> <li>Make sure that a straight cable is used for connection to a switching hub.</li> </ul>
	<ul style="list-style-type: none"> <li>Network malfunction</li> </ul>	<ul style="list-style-type: none"> <li>Make sure that all network devices in use are switched on.</li> </ul>

### 7.1.1 Installation

---

<b>PROBLEM</b>	<b>PROBABLE CAUSE</b>	<b>SOLUTION</b>
The LED of the Expansion Unit card is not green.	The LAN cable is not connected properly.	<ul style="list-style-type: none"><li>• Check the LAN cable connections.</li></ul>
	There was a failure in the stacking card.	<ul style="list-style-type: none"><li>• Replace the stacking EXP-M card.</li></ul>



## 7.1.2 Connection

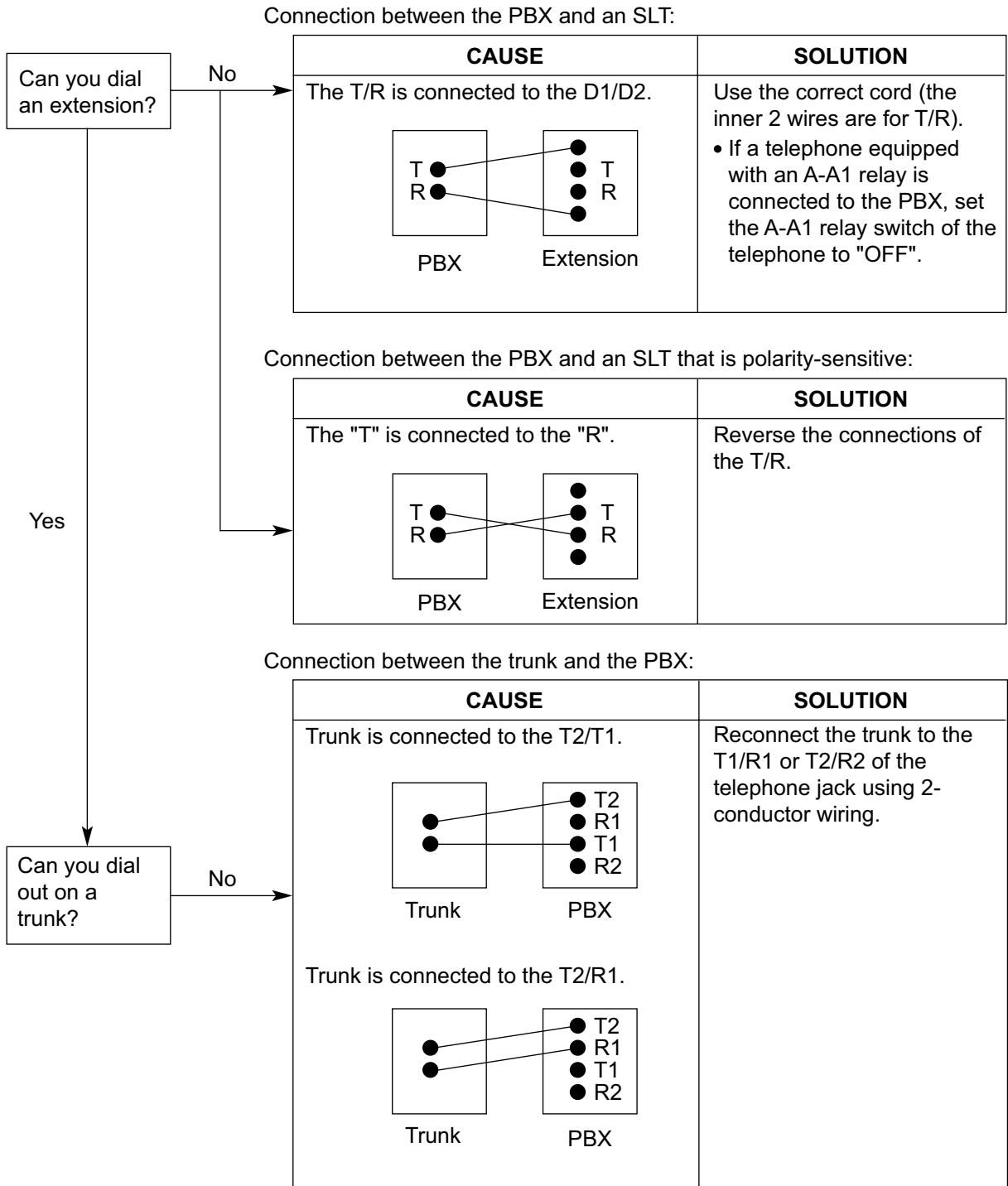

## 7.1.3 Operation

### Note

For devices connected to a PBX other than the KX-NS300, refer to the Troubleshooting for that PBX.

PROBLEM	PROBABLE CAUSE	SOLUTION
<ul style="list-style-type: none"> <li>Cannot set the IP address, subnet mask address, and PBX IP address to the IP-PT.</li> </ul>	<ul style="list-style-type: none"> <li>An unusable value is being set.</li> </ul>	<ul style="list-style-type: none"> <li>Set an IP address within the valid range. IP address of the IP-PT/PBX: "1.0.0.0" to "223.255.255.255" Subnet mask address: "0-255.0-255.0-255.0-255" (except "0.0.0.0" and "255.255.255.255")</li> </ul>
<ul style="list-style-type: none"> <li>Cannot register the IP-PT.</li> </ul>	<ul style="list-style-type: none"> <li>The necessary network parameters are not set to the IP-PT.</li> </ul>	<ul style="list-style-type: none"> <li>When not using the DHCP Server feature or an external DHCP server, set the IP address, subnet mask address, and enter the PBX IP address. If necessary, also enter the IP address of the default gateway.</li> <li>When using the DHCP Server feature or an external DHCP server, enter the PBX IP address.</li> </ul>
<ul style="list-style-type: none"> <li>The IP-PT cannot connect to the PBX.</li> </ul>	<ul style="list-style-type: none"> <li>The wrong IP address, subnet mask address, PBX IP address, or default gateway address was entered.</li> </ul>	<ul style="list-style-type: none"> <li>Check each parameter and enter the correct value.</li> </ul>
	<ul style="list-style-type: none"> <li>The Ethernet cable is not connected correctly.</li> </ul>	<ul style="list-style-type: none"> <li>Check the Ethernet cable connections.</li> </ul>
	<ul style="list-style-type: none"> <li>The DHCP server is not active.</li> </ul>	<ul style="list-style-type: none"> <li>Restart the external DHCP server.</li> <li>Confirm whether the DHCP Server feature is enabled.</li> <li>Disable DHCP and re-enter settings as appropriate.</li> </ul>
<ul style="list-style-type: none"> <li>Whenever you try to make calls using a SIP phone, a busy tone is heard.</li> </ul>	<ul style="list-style-type: none"> <li>The status of the port that the SIP phone is connected to is Out of Service.</li> </ul>	<ul style="list-style-type: none"> <li>Change the port status from Out of Service to In Service using Web Maintenance Console.</li> </ul>
<ul style="list-style-type: none"> <li>The IP-PT does not ring.</li> </ul>	<ul style="list-style-type: none"> <li>The ringer volume is off.</li> </ul>	<ul style="list-style-type: none"> <li>Turn on the ringer volume.</li> </ul>
<ul style="list-style-type: none"> <li>Originating an outside call, call transfer, or conference cannot be performed.</li> </ul>	<ul style="list-style-type: none"> <li>The corresponding flexible button does not exist on the PT.</li> </ul>	<ul style="list-style-type: none"> <li>Programme the flexible button. Refer to "2.21.1 Fixed Buttons" in the Feature Guide.</li> </ul>
<ul style="list-style-type: none"> <li>The IP address of the PBX for networking has been forgotten.</li> </ul>	-	<ul style="list-style-type: none"> <li>You can check the current IP address by PT Programming. For details, refer to the PT Programming [991] in PT Programming Manual.</li> </ul>

## 7.1.4 Error Messages

When a major system error occurs, an error message is displayed on the IP-PT.

For IP-PTs with a single line display (e.g., KX-NT265), only an error code (i.e., ERR XXXX-XXXX) will be displayed.

Error Message & IP-PT Activity	Probable Cause	Solution
<b>ERR 1001-0000</b> <b>HARDWARE ERROR</b> Displays error and stops operating.	<ul style="list-style-type: none"> <li>Sub CPU malfunction</li> </ul>	<ul style="list-style-type: none"> <li>Repair or replace the IP-PT.</li> </ul>
<b>ERR 1002-0000</b> <b>HARDWARE ERROR</b> Displays error and stops operating.	<ul style="list-style-type: none"> <li>Sound hardware malfunction</li> </ul>	
<b>ERR 1003-0000</b> <b>HARDWARE ERROR</b> Displays error and stops operating.	<ul style="list-style-type: none"> <li>Flash memory malfunction</li> </ul>	
<b>ERR 1004-XXXX</b> <b>HARDWARE ERROR</b> Displays error and stops operating.	<ul style="list-style-type: none"> <li>PHY (network control IC) error</li> </ul>	
<b>ERR 1005-0000</b> <b>HARDWARE ERROR</b> Displays error and stops operating.	<ul style="list-style-type: none"> <li>SDRAM error</li> </ul>	
<b>ERR 1006-0000</b> <b>HARDWARE ERROR</b> Displays error and stops operating.	<ul style="list-style-type: none"> <li>SRAM error</li> </ul>	
<b>ERR 1007-0000</b> <b>HARDWARE ERROR</b> Displays error and stops operating.	<ul style="list-style-type: none"> <li>Sub CPU malfunction for Self Labelling</li> </ul>	
<b>ERR 1051-0000</b> <b>SOFTWARE ERROR</b> Displays error and stops operating.	<ul style="list-style-type: none"> <li>PBX software version error</li> </ul>	<ul style="list-style-type: none"> <li>Consult your network administrator.</li> </ul>
<b>ERR 2001-XXXX</b> <b>SYSTEM ERROR</b> Resets and displays error for 5 seconds while starting up.	<ul style="list-style-type: none"> <li>Unexpected error</li> </ul>	<ul style="list-style-type: none"> <li>If this error is displayed frequently, repair or replace the IP-PT.</li> </ul>
<b>ERR 2002-0000</b> <b>POOR LAN CONNECTION</b> Resets and displays error for 5 seconds while starting up.	<ul style="list-style-type: none"> <li>Transmission error</li> </ul>	<ul style="list-style-type: none"> <li>Check with the network administrator whether there is a problem with the LAN.</li> <li>If this error is displayed frequently, repair or replace the IP-PT.</li> </ul>
<b>ERR 2003-0000</b> <b>POOR LAN CONNECTION</b> Resets and displays error for 5 seconds while starting up.		

## 7.1.4 Error Messages

Error Message & IP-PT Activity	Probable Cause	Solution
<b>ERR 2004-0000</b> <b>UNREGISTERED TO SERVER</b> Resets and displays error for 5 seconds while starting up.	<ul style="list-style-type: none"> <li>IP-PT not registered</li> </ul>	<ul style="list-style-type: none"> <li>Check the registration status of the IP-PT.</li> </ul>
<b>ERR 2005-0000</b> <b>NO MORE CONNECTIONS</b> Resets and displays error for 5 seconds while starting up.	<ul style="list-style-type: none"> <li>Connection refused by the PBX</li> </ul>	
<b>ERR 2006-XXXX</b> <b>DHCP SERVER REJECTION</b> Resets and displays error for 5 seconds while starting up.	<ul style="list-style-type: none"> <li>IP address lease time from DHCP server has expired</li> <li>IP address lease renewal was refused by DHCP server</li> </ul>	<ul style="list-style-type: none"> <li>Consult your network administrator.</li> </ul>
<b>ERR 2007-0000</b> <b>HARDWARE ERROR</b> Resets and displays error for 5 seconds while starting up.	<ul style="list-style-type: none"> <li>Communication error with sub CPU</li> </ul>	<ul style="list-style-type: none"> <li>If this error is displayed frequently, repair or replace the IP-PT.</li> </ul>
<b>ERR 2008-0000</b> <b>HARDWARE ERROR</b> Resets and displays error for 5 seconds while starting up.	<ul style="list-style-type: none"> <li>Sound hardware control error</li> </ul>	
<b>ERR 2009-XXXX</b> <b>MGCP SERVER REJECTION</b> Resets and displays error for 5 seconds while starting up.	<ul style="list-style-type: none"> <li>Error information from the PBX (MGCP server)</li> </ul>	<ul style="list-style-type: none"> <li>Consult your network administrator.</li> </ul>
<b>ERR 2010-0000</b> <b>HARDWARE ERROR</b> Resets and displays error for 5 seconds while starting up.	<ul style="list-style-type: none"> <li>Communication error with sub CPU for Self Labelling</li> </ul>	<ul style="list-style-type: none"> <li>If this error is displayed frequently, repair or replace the IP-PT.</li> </ul>
<b>ERR 3001-0000</b> <b>HARDWARE ERROR</b> Displays error until reset the IP-PT.	<ul style="list-style-type: none"> <li>Communication error with sub CPU</li> </ul>	
<b>ERR 3002-0000</b> <b>HARDWARE ERROR</b> Displays error until reset the IP-PT.	<ul style="list-style-type: none"> <li>Sound hardware control error</li> </ul>	
<b>ERR 3003-XXXX</b> <b>DHCP SERVER NOT FOUND</b> Displays error until reset the IP-PT.	<ul style="list-style-type: none"> <li>IP address lease renewal was refused by DHCP server</li> </ul>	<ul style="list-style-type: none"> <li>Consult your network administrator.</li> </ul>
<b>ERR 3100-0000</b> <b>BLUETOOTH ERROR</b> Resets the Bluetooth® wireless headset.	<ul style="list-style-type: none"> <li>Bluetooth hardware error</li> </ul>	<ul style="list-style-type: none"> <li>Repair or replace the Bluetooth wireless headset.</li> </ul>

## 7.1.5 Restarting the KX-NS300

If the PBX does not operate properly, restart the PBX using Web Maintenance Console. Before restarting the PBX, try the system feature again to confirm whether there definitely is a problem or not.

### Note

- When the System Mode Switch is set to "NORMAL", restarting the PBX causes the following:
  - Camp-on is cleared.
  - Calls on hold are terminated.
  - Calls on exclusive hold are terminated.
  - Calls in progress are terminated.
  - Call park is cleared.
 Other data stored in memory, except the above, are not cleared.
- Be aware that restarting the PBX with the System Mode Switch in the "SYSTEM INITIALIZE" position clears all data stored in the PBX. Do not perform this operation unless you intend to delete all data from the PBX.
- When the PBX is set to obtain IP addressing information automatically, and the PBX is not able to obtain appropriate IP addressing information from an external DHCP server, the PBX starts up with its default IP addresses and the STATUS indicator on the front of the cabinet turns red. For the default IP addresses, refer to "5.3 Starting Web Maintenance Console".

## Operation

If the PBX does not operate properly:

1. Slide the System Mode Switch to the "NORMAL" position.

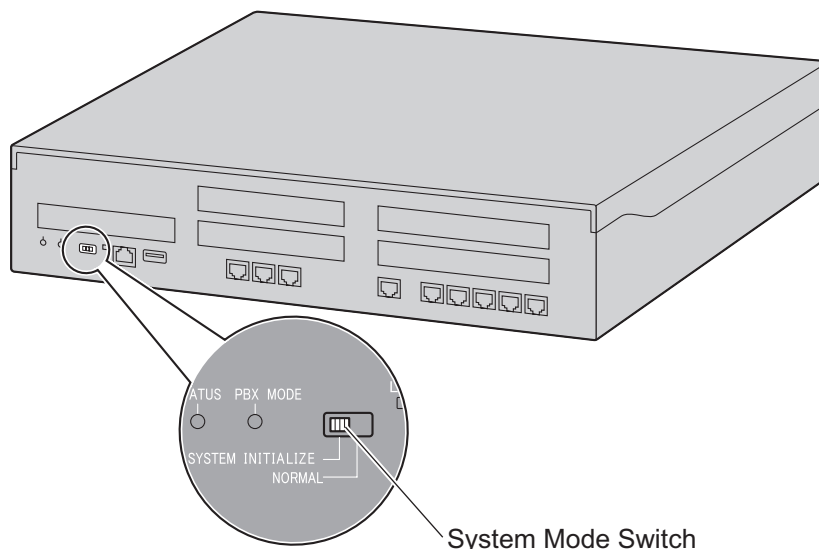

2. Start the Web Maintenance Console.
3. Log in using the Installer level account.
4. On the Home screen, click **Maintenance** → **System Control** → **System Reset**.
5. Follow the prompts.  
Restarting the PBX will start.

### Note

- When the power switch is turned on, or when the PBX recovers from a power failure, the PBX will restart. The time required to restart depends on the number of connected extensions.

### 7.1.5 Restarting the KX-NS300

---

**Example:**

<b>PBX</b>	<b>Extensions</b>	<b>Estimated Time for Starting Up</b>
KX-NS300	128 KX-UT series SIP phones	more than 5 minutes

- PBX functions cannot be used until restarting is complete. The use of a UPS is recommended; even a momentary power failure can result in a long delay as the PBX restarts, requiring the time as shown above.

## 7.1.6 Troubleshooting by Error Log

When a major system error occurs in the PBX, the STATUS indicator on the front of the cabinet turns red, and the system logs the error information.

### Error Log Display Format

Below is the display format of the error log. For information about how to view the error log using Web Maintenance Console, refer to "7.3.1 Utility—Log—Error Log" in the PC Programming Manual.

#### Example: Web Maintenance Console

Index	Date	Time	Error Code	Sub Code	Error Message
1	08/06/2012	13:25:07	393	50501	LAN/WAN Carrier detected
2	08/06/2012	12:02:43	307	50501	LAN/WAN No Carrier
3	08/06/2012	11:02:53	393	50501	LAN/WAN Carrier detected
4	08/06/2012	10:46:12	307	50501	LAN/WAN No Carrier
5	08/06/2012	09:51:03	393	50501	LAN/WAN Carrier detected

#### Example: Station Message Detail Recording (SMDR)

```

01/01/10 01:00AM MJ ALM #014 00 10000 FAN Alarm
01/01/10 01:39AM MN ALM #091 00 10000 PT connection over
  
```

1
2
3
4
5
6

#### Description

	Item	Description
1	Date	The date of the error detection.
2	Time	The time of the error detection.
3	Level	Minor (MN ALM)
		Major (MJ ALM)
4	Error Code	The 3-digit error code assigned by the PBX.

### 7.1.6 Troubleshooting by Error Log

---

	Item	Description
5	Sub Code	<b>SMDR:</b> The 8-digit sub code of the relevant hardware (BBWXYZZ). <b>Web Maintenance Console:</b> The 6-digit sub code of the relevant hardware (WXYZZ).  For details about the contents of error sub codes, refer to "7.3.1 Utility—Log—Error Log" in the PC Programming Manual.
6	Error Message	A description of the error.
7	Log Information	Displays probable causes of the errors and their solutions.



---

## **Section 8**

# ***Networking Information***

*This section provides information about topics such as using the PBX in a VoIP network, and the TCP ports used by the PBX.*

## 8.1 Information about Using an IP Network

This section explains common IP network information necessary for setting up QSIG networks.

### 8.1.1 Using a VoIP Network with the PBX

This PBX supports Panasonic KX-NT300 series, KX-NT500 series, and KX-NT265 IP proprietary telephones (IP-PTs), Panasonic IP softphones, and SIP (Session Initiation Protocol) phones (hardphones and softphones) for communication on a Voice over Internet Protocol (VoIP) network. These IP telephones can be used as extensions of the PBX when the local office LAN is connected to other LANs at different locations.

This PBX also enables VoIP communication with PBXs installed at different locations. Since the communication does not take place over conventional telephone network, the high cost of long distance communication is virtually eliminated.

To establish a VoIP network, the virtual cards are used according to the requirement of the network. For details about virtual cards, see "4.4 Virtual Cards".

The following diagrams illustrate VoIP network with (i) a remote office LAN and (ii) another PBX installed at different location.

#### Note

Panasonic IP Cell Station (IP-CS) units are also supported by this PBX for communication on a VoIP network. For details, refer to the Quick Installation Guide for the IP-CS.

#### (i) Connection Outline of VoIP Network with Remote Office LAN

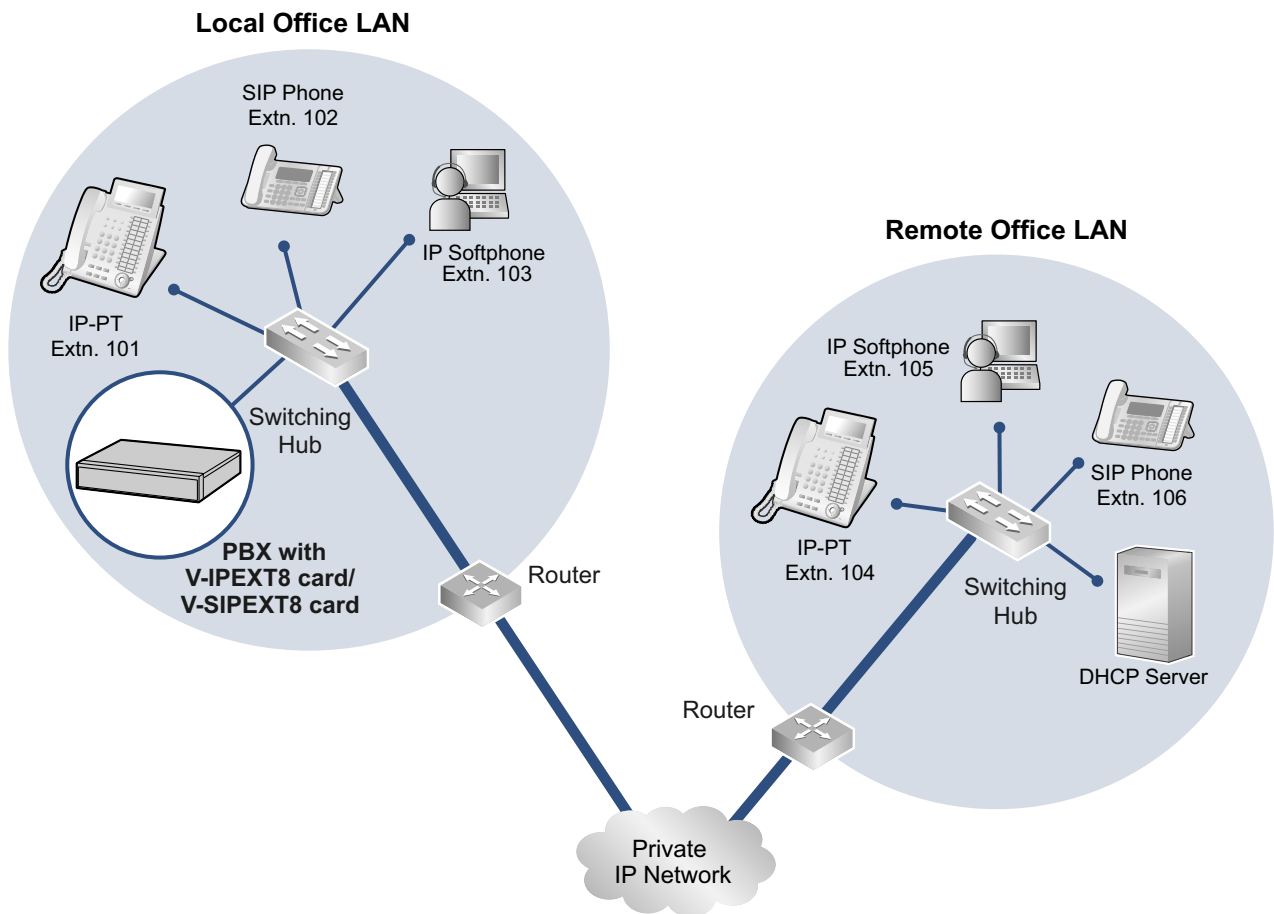

## (ii) Connection Outline of VoIP Network with PBX in Other Network

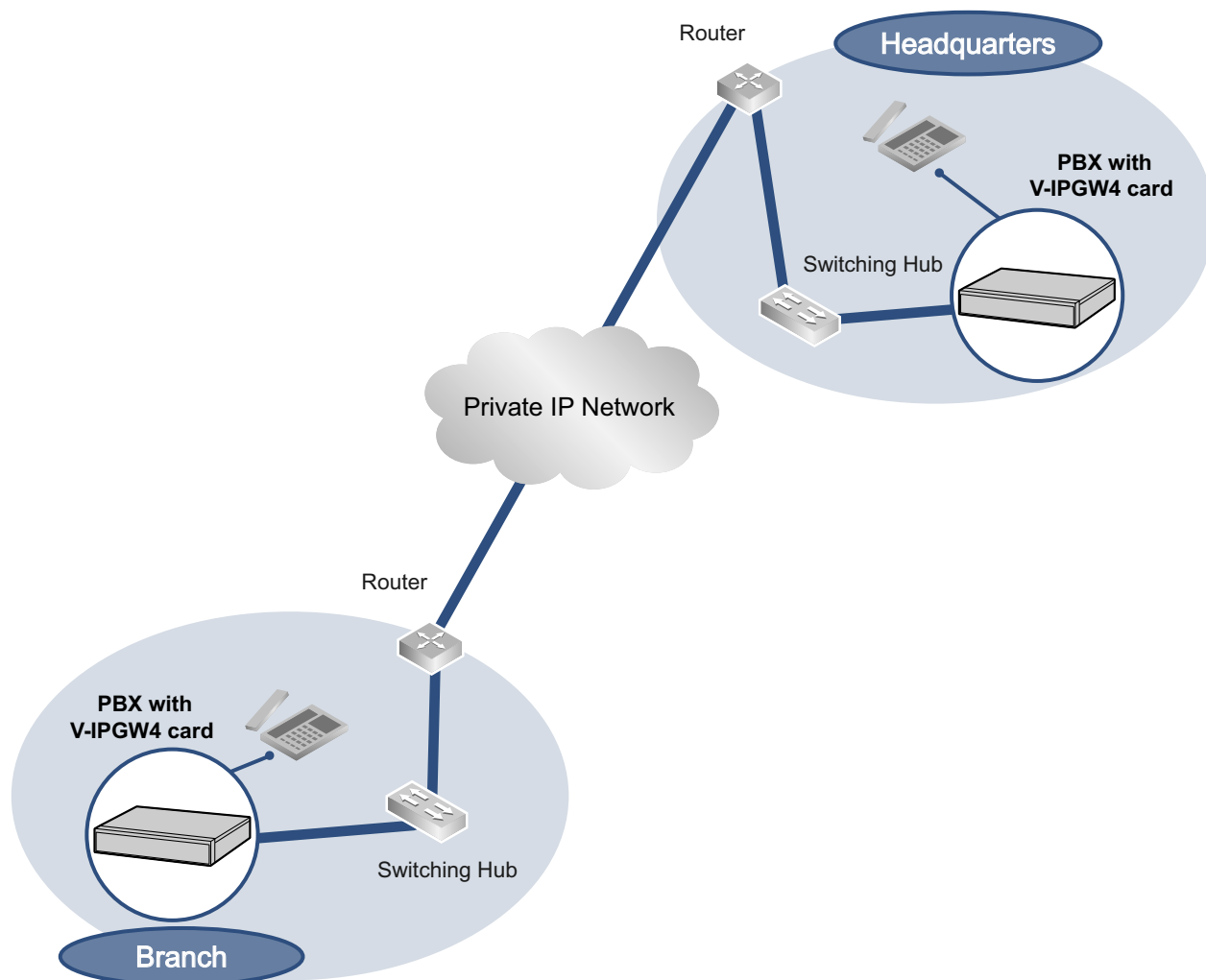

## Network Parameters

You will need to have the following IP addressing and QoS information to establish VoIP communication on your network. This information is typically supplied by a network administrator. Consult your network administrator for specific values.

Parameter	Description
IP telephone IP Address	Identifies the location of IP telephones on the network. Each IP telephone must have a unique IP address.
Subnet Mask Address	Defines which digits of an IP address are used for the network address and the host address at each network location. The IP addresses of the IP telephones and the PBX must fall within the same subnet as that of the default gateway (e.g., router) of the LAN.
Default Gateway Address	Identifies the IP address of the primary gateway (typically a router or similar device) that exchanges IP packets with the other gateways on the VoIP network.

### 8.1.1 Using a VoIP Network with the PBX

---

Parameter	Description
PBX IP Address	Identifies the location of the PBX in the network during VoIP communications.
VLAN ID	Identifies the ID of the logical segment within the corporate LAN, through which voice packets from IP telephones travel. For details, refer to "8.1.3 VLAN (Virtual LAN)".
DiffServ (DS)	Identifies the value for the DS field in the header of IP packets, which determines the priority given to packets travelling from IP telephones. For details, refer to "5.7.4 Setting Diffserv Parameters".

## Types of IP Network

The speech quality depends on the type of IP network in use. Managed IP networks provide better speech quality compared to unmanaged networks such as satellite communications, where quality of service cannot be guaranteed.

#### Examples of recommended IP networks

- Digital Leased Line
- IP-VPN (Virtual Private Network)
- Frame Relay

#### Not recommended

- Satellite communications (Very Small Aperture Terminal system [VSAT], etc.)

#### Note

- Peer-to-peer calls between IP telephones installed at different locations may not be possible if packet communication cannot be established between the respective networks. In this case, you need to configure the network settings (e.g., a VPN router when using an IP-VPN) to establish packet communication.
- Unlike an IP-VPN, which is set up over a network provider's own IP network, an Internet VPN is set up over the Internet. Internet VPNs are not recommended for VoIP communication because transmission delays and loss of data are likely to occur.

## 8.1.2 DHCP (Dynamic Host Configuration Protocol) Server

To establish communication over a VoIP network, IP addresses must be assigned to IP telephones and the PBX to identify their locations on the network. While these addresses can be assigned manually, it is also possible to use a DHCP server to automatically assign IP address information. The KX-NS300 has a DHCP Server feature. Therefore, the PBX can act as a DHCP server or DHCP client depending on its settings. When the PBX's DHCP Server feature is enabled, it allows you to centrally manage and automate the assignment of IP addresses with Web Maintenance Console. For details, refer to "◆ DHCP Server" in the PC Programming Manual.

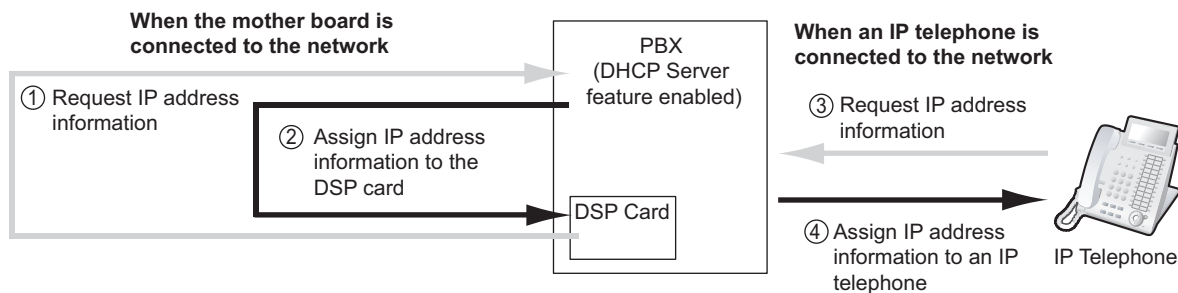

### Note

- The DHCP Server feature is disabled by default. To enable the feature, refer to "5.4.2 Enabling the DHCP Server Feature".
- An IP telephone and the mother board/DSP card cannot request IP addresses from a DHCP server on another LAN (connected through an IP network). They can only receive IP addresses from a DHCP server on the same LAN. Therefore, when IP telephones are located on several LANs, a DHCP server is required on each LAN. If a DHCP server is not present on the LAN, IP addresses for IP telephones and the mother board/DSP card on that LAN must be assigned manually.
- When the PBX has been set to act as a DHCP client, use an external DHCP server to assign IP address information automatically.
- When the KX-NS300 is set as the DHCP client and cannot receive appropriate IP addressing information from an external DHCP server, the PBX keeps using the previous effective IP addressing information and checks whether any overlapping of IP addresses exists. If the IP address of the PBX overlaps with another IP address, the PBX displays a warning to encourage changing the IP address of the PBX.

### 8.1.3 VLAN (Virtual LAN)

VLANs are logical segments within a corporate LAN. By assigning VLAN settings to IP telephones, it is possible to separate the packets transmitted by an IP telephone according to the type of data and specify which VLAN each data type will be sent over. This allows you to avoid generating unnecessary network traffic on each segment and to reduce the load on the network. As a consequence, speech quality can be assured. Therefore, we recommend using the VLAN feature to perform VoIP communication effectively.

Some IP telephones (e.g., KX-NT300 series) are equipped with 2 ports, primary and secondary, for packet communication. Allocating these ports to different VLANs enables you to split the paths for packets depending on whether the packet contains voice signals or data.

VLAN settings (VLAN ID and VLAN priority) for the primary port affect voice data transmitted by the IP telephone, whereas VLAN settings for the secondary port apply to data transmitted by a PC connected to the IP telephone. When sending packets, the IP telephone can attach information on which VLAN the packets are to be transmitted over (VLAN Tagging). The switching hub that receives these packets reads the VLAN information and sends the packets over the appropriate VLAN. This helps to ensure bandwidth for IP telephone voice transmissions.

In this way, an IP telephone with 2 ports can transmit voice packets from the primary port with higher priority than other packets from the secondary port.

**Notice**

The PBX's LAN port does not support VLAN tagging. Therefore, connect the PBX's LAN port to a port of the switching hub that is set to "Untagged", and the IP telephone to a port set to "Trunk", to allow VLAN tagging. Consult your network administrator for details.

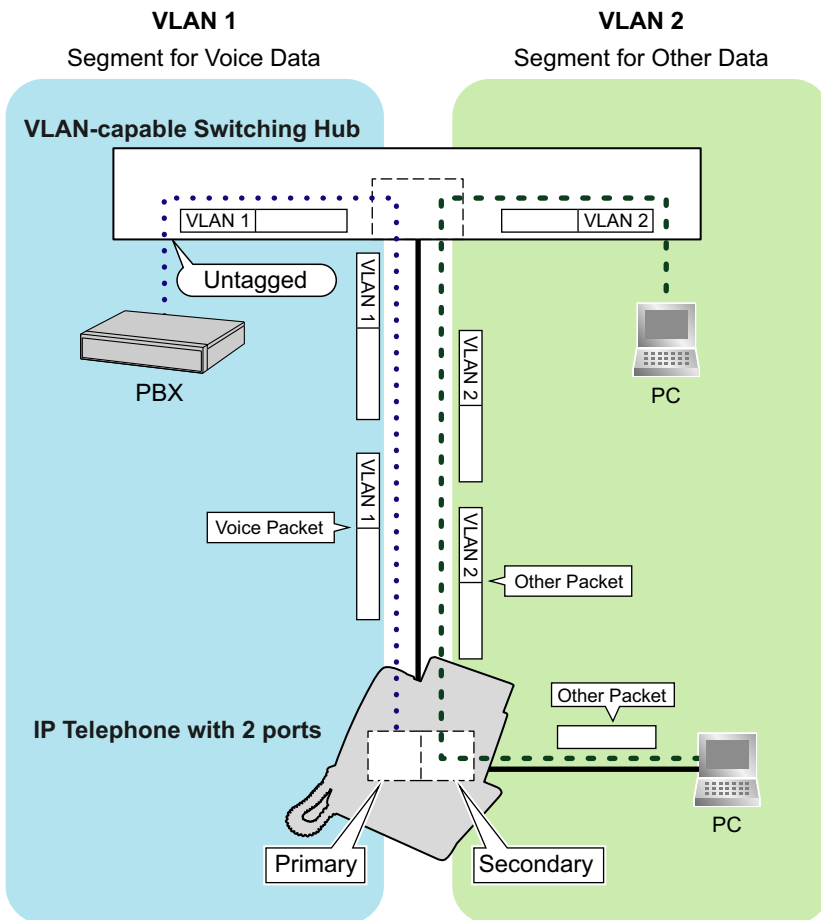

**Note**

- This VLAN feature complies with IEEE (Institute of Electrical and Electronics Engineers) 802.1Q.
- The PBX receives VLAN settings only from the connected switching hub. Therefore, VLAN settings for the PBX must be assigned at the switching hub.
- When using the VLAN feature on the network, make sure that the main unit is connected to a layer 2 switch that is IEEE 802.1Q compliant, and that is configured for VLANs. In addition, the port of the switching hub to which the card is connected must be set to "Untagged". Consult your network administrator for details.
- When using the VLAN feature on the network, make sure that the switching hub to be connected is IEEE 802.1Q compliant and is configured for VLANs. In addition, the port of a switching hub that the IP telephone is connected to must be set to "Trunk" port, to allow VLAN tagging. Consult your network administrator for details.
- Some PC LAN cards allow VLAN settings to be assigned. However, when using a PC connected to an IP telephone with 2 ports, the VLAN settings for PC communications must be assigned only to the secondary port of the IP telephone. Any VLAN settings assigned to the PC LAN card must be disabled. These settings can usually be identified by "802.1Q", "802.1p", or "VLAN" in their name.
- If you are using an IP telephone with a primary port only (e.g., KX-NT265), a PC cannot be connected to the IP telephone.

## 8.1.4 Jitter Buffer

When voice signals are packetised and transmitted, individual packets can take different paths through the network and arrive at the destination at varied timings. This is referred to as "jitter", and it can cause degradation in speech quality. To compensate for jitter problems, the "jitter buffer" accumulates the packets temporarily for processing.

To set the size of the jitter buffer, refer to "9.2.2 PBX Configuration—[1-1] Configuration—Slot—System Property—Site—VoIP-DSP Options" in the PC Programming Manual.

## 8.1.5 Voice Activity Detection (VAD)

VAD conserves bandwidth by detecting silent periods during a call and suppressing the packets of silence from being sent to the network. This feature can be enabled or disabled for codec G.711.

To configure the VAD feature, refer to the appropriate section in the PC Programming Manual.

## 8.1.6 Network Configuration

You must evaluate the structure of the existing network to see if a VoIP network can be implemented. Below are the points that should be evaluated.

### Is the IP network a managed network?

A VoIP network should be implemented on a managed IP network such as Frame Relay, Leased Line, or IP-VPN (Virtual Private Network).

An unmanaged network, such as the Internet (including an Internet VPN), cannot be used to employ a VoIP network because delays and loss in data transmission can cause huge degradation in speech quality.

### Is it possible to have static IP addressing?

IP telephones on the network always perform VoIP communications through the PBX. Therefore, the PBX must be assigned static IP addresses, which must be programmed to each IP telephone on the network.

#### Note

When the DHCP Server feature is disabled and external DHCP servers are not used, static IP addressing must also be enabled for all IP telephones.

### Does only a single router provide access to the IP network?

In a dual network, 2 routers provide access to the IP network as shown in the diagram below. However, only one router can be used as an access point to the network.

Therefore, in the diagram below, if router A, whose IP address is assigned as the default gateway IP address of the PBX and the IP telephones, fails, VoIP communications are no longer possible; they are not able to switch their default gateway from router A to router B to access the IP network.

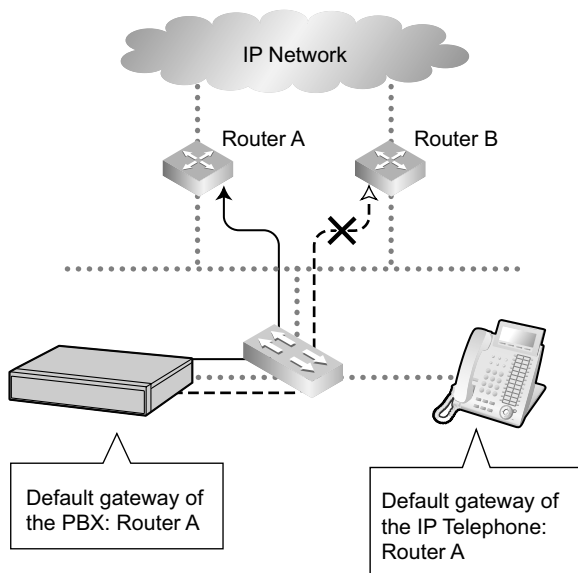



## How is the PBX connected to remote extensions?

When the PBX is connected to a remote extensions via public IP network without using IP-VPN, address translation techniques (e.g., NAT/NAPT) are used. These methods prevent VoIP communications from being carried out effectively. In such cases, the use of an SBC will avoid this problem.

### Note

- An SBC is not required for:
  - Connections via a Wide Area Ethernet or LAN
  - Connections via IP-VPN
- An SBC is required for:
  - Connections via a public IP network

Connection via Wide Area Ethernet or LAN

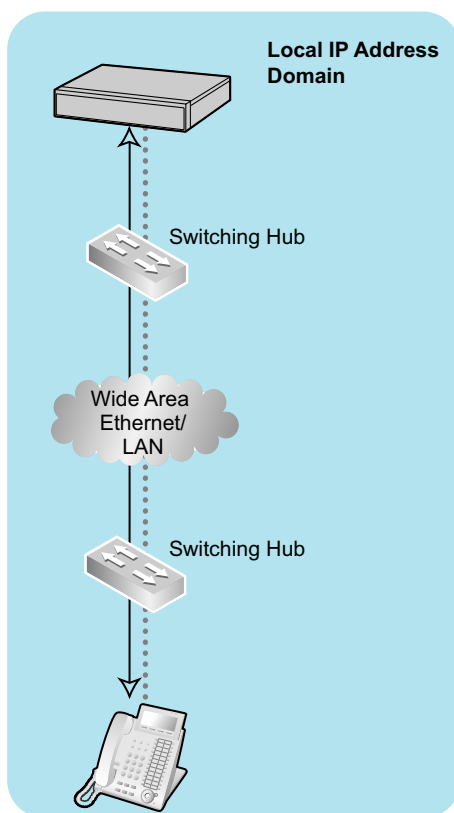

Connection via IP-VPN

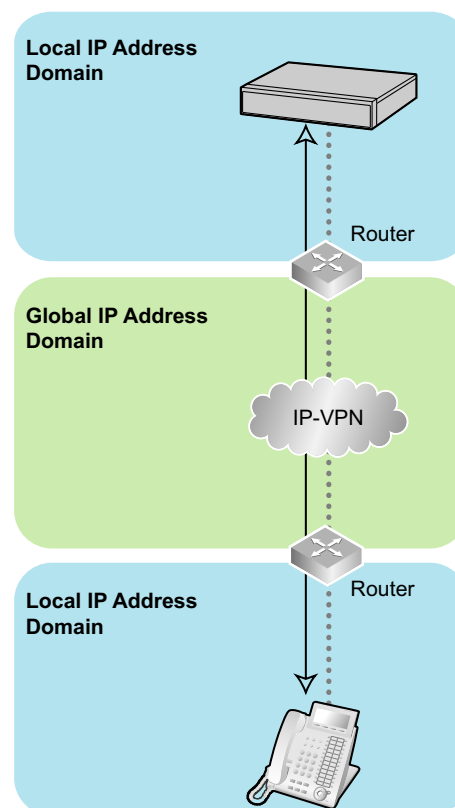

## 8.1.6 Network Configuration

---

### Connection via Public IP Network

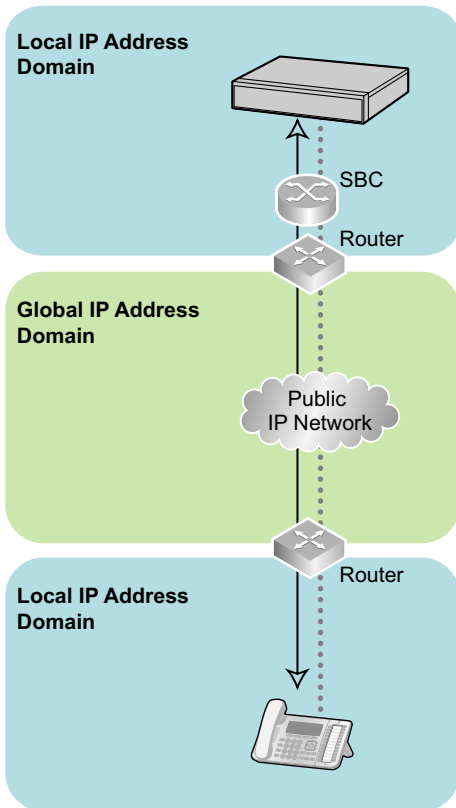

## Are the network devices located appropriately for effective VoIP communications?

Transmission delays can cause pauses and loss in VoIP communications. The more network devices (e.g., routers and switching hubs) there are between the PBX and IP telephones or the IP network interface, the longer the transmission delays. This is because a certain amount of delay is inevitable when packets go through each network device.

To prevent unnecessary delays, it is recommended to connect the PBX as close to the IP telephones and the IP network interface as possible so that the number of the network devices is kept to a minimum.

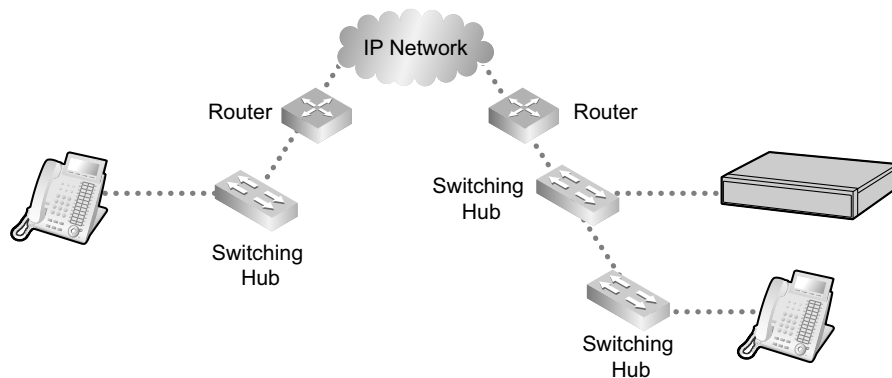

### 8.1.7 Network Devices

You must evaluate the network devices that are used in the existing network to see if a VoIP network can be implemented. Below are the points that should be evaluated.

#### Can the firewall pass packets appropriately?

If the VoIP network contains a firewall, the firewall must be configured appropriately to allow VoIP packets to pass through the network without being blocked by filtering. For details about the protocols and port numbers that the PBX uses for VoIP communication, refer to "8.5 Port Security".

The ports for which you need to configure the firewall may vary depending on the network conditions. For more information, consult your network administrator.

#### Are layer 2 or higher switches used?

Use of repeater hubs can increase the network load, and therefore may result in degradation in speech quality. To ensure high speech quality, use only layer 2 or higher switches. Use of layer 2 or higher switches is also strongly recommended for connecting IP telephones.

##### **Note**

Note that the port of the switching hub that connects to the mother board should be set to operate under "Auto Negotiation" mode.

#### Are Category 5 (CAT 5) or higher cables used for 10BASE-T/100BASE-TX?

When connecting network devices, make sure to use CAT 5 or higher cables for 10BASE-T/100BASE-TX connection. If other types of cables are used, communication may not be carried out normally.

## 8.1.8 QoS (Quality of Service)

Some routers permit the configuration of priority control features. This allows the router to give higher priority to voice packets and lower the rate of loss and delays during transmissions, hence improving speech quality. It is strongly recommended that you use this feature, especially in networks where traffic is heavy.

Typically, a router identifies what packets to pass in priority by checking the value in the ToS field of the header of IP packets. The V-IPGW4 card has the ability to set the ToS field of outgoing voice packets. When the card is appropriately configured, the router can give voice packets from the card higher priority.

Consult your network administrator when setting the ToS field, as the setting value must conform to the router's specifications.

### **Note**

- Some switches also permit the configuration of priority control features. For more information, consult your network administrator.
- To adjust the value in the ToS field, refer to "9.11 PBX Configuration—[1-1] Configuration—Slot—V-IPGW—Shelf Property" in the PC Programming Manual.

### 8.1.9 Network Time Protocol (NTP)

The KX-NS300 can be configured to contact an NTP server to receive and update its time setting automatically. KX-UT series SIP phones can receive and update their time setting either through the KX-NS300 or by contacting an NTP server directly.

For a SIP phone to receive and update its time setting via the KX-NS300, the NTP server feature must be enabled. To enable this feature refer to "27.2.4 Network Service—[2-5] Server Feature—NTP" in the PC Programming Manual.

If the NTP server feature is enabled:

- Case 1: An NTP server is specified in Web Maintenance Console.
  - The SIP phones use the specified IP address and contact the NTP server directly.
- Case 2: An NTP server is *not* specified in Web Maintenance Console.
  - The SIP phones use the IP address of the KX-NS300 as their NTP server.  
(The KX-NS300 acts as an NTP server for the SIP phones.)

To specify the IP address of the NTP server, refer to "10.1.2 PBX Configuration—[2-1-2] System—Date & Time—SNTP / Daylight Saving" in the PC Programming Manual.

If the NTP server feature is disabled, the SIP phones use their own time settings.

## 8.2 H.323 Trunks

This section explains information that is necessary for setting up a H.323 QSIG network over an IP network.

### 8.2.1 Avoid Multiple IP Networks

A huge degradation in speech quality will be produced when calls are made through multiple IP networks as shown below; therefore, it is recommended that you avoid establishing a VoIP network in this fashion.

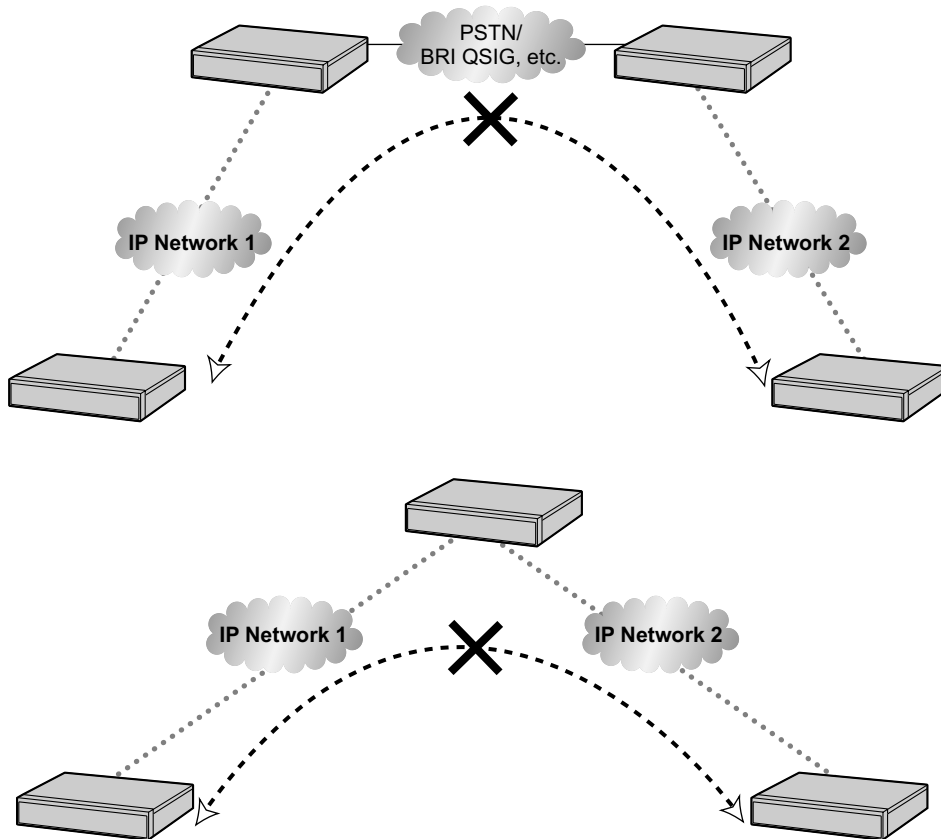

## 8.2.2 Gatekeeper

The following are the general functions of a gatekeeper:

- Dialed number-to-IP address translation
- Authentication
- Bandwidth control

The gatekeeper provides these network management functions to registered clients. To register with the gatekeeper, you need to configure the V-IPGW4 card to use the gatekeeper and programme the GK Settings table through system programming. For details, refer to "9.11 PBX Configuration—[1-1] Configuration—Slot—V-IPGW—Shelf Property—◆ Gatekeeper Available" and "9.11.1 PBX Configuration—[1-1] Configuration—Slot—V-IPGW—Shelf Property—GK Settings" in the PC Programming Manual. After programming, the V-IPGW4 card attempts to register with the gatekeeper using registration information such as the IP address of the mother board, and destination telephone numbers specified in the GK Settings table.

### Note

- For more information about gatekeeper functions, consult the documentation of the gatekeeper.
- When using a gatekeeper, make sure to choose a compatible model. For more information about gatekeeper compatibility with the V-IPGW4 card, consult a certified dealer.

## 8.2.3 Bandwidth Assessment

When using the IP telephones and V-IPGW4 card, you must ensure that the IP network in use has enough bandwidth to support VoIP communications. If the amount of bandwidth required for VoIP communications is more than the network can accommodate, speech quality will be compromised. In addition, there may be an adverse effect on the performance of other applications (e.g., e-mail or Web applications) that use the same network. Therefore, care must be taken when assessing bandwidth requirements.

Inform your network administrator of the required bandwidth, and make sure that the network can support VoIP communications even under conditions of maximum network traffic.

## Bandwidth Assessment for IP Extension Card

### Required Bandwidth per IP Telephone for a Call

The required bandwidth depends on what combination of codecs and packet sending intervals is used. Keep in mind the following points about the type of codecs and packet sending intervals, in terms of speech quality:

- The speech quality of the codecs varies as follows: (High) G.722, G.711, G.729A (Low)<sup>\*1</sup>
- The shorter the packet sending interval, the higher the speech quality.
- The higher the speech quality the IP telephones provide, the more bandwidth the IP telephones require.

<sup>\*1</sup> When the preferred codec of each party differs, the call will be established using the lower codec. For example, if the caller prefers G.711 while the called party prefers G.729A, the call will be established using G.729A.

Codec	Packet Sending Interval			
	20 ms	30 ms	40 ms	60 ms
G.722 <sup>*1</sup> /G.711	87.2 kbps	79.5 kbps	—	—
G.729A	31.2 kbps	23.5 kbps	19.6 kbps	15.7 kbps

<sup>\*1</sup> G.722 is only available for calls between KX-NT300 series IP-PTs, KX-NT500 series IP-PTs, and some SIP phones that support this codec during peer-to-peer communication. For details, refer to "5.2.3 Peer-to-Peer (P2P) Connection" in the Feature Guide.



### Required Bandwidth for Each IP Extension Card

To allow all IP telephones to make calls simultaneously, it is necessary to keep available the bandwidth required by an IP extension card with the maximum number of IP telephones connected.

Provided below is the formula to calculate the amount of bandwidth required for each IP extension card.

**When using the V-IPEXT8/V-SIPEXT8 card:**

Required Bandwidth = (Required Bandwidth per IP telephone × 32)

## Bandwidth Assessment for V-IPGW4 Card

### Required Bandwidth for One VoIP Channel

The required bandwidth depends on what combination of codecs and packet sending intervals is used. Keep in mind the following points about the type of codec and packet sending interval, in terms of the speech quality:

- The speech quality of the G.711 codec is higher than that of the G.729A codec.
- The shorter the packet sending interval, the higher the speech quality.
- The higher the speech quality the V-IPGW4 card provides, the more bandwidth the card requires.

#### Via LAN

Codec	Packet Sending Interval				
	20 ms	30 ms	40 ms	60 ms	90 ms
G.711	87.2 kbps	79.5 kbps	75.6 kbps	71.7 kbps	—
G.729A	31.2 kbps	23.5 kbps	19.6 kbps	15.7 kbps	—

#### Via WAN (PPP: Point-to-Point Protocol)

Codec	Packet Sending Interval				
	20 ms	30 ms	40 ms	60 ms	90 ms
G.711	84 kbps	77.3 kbps	74 kbps	70.7 kbps	—
G.729A	28 kbps	21 kbps	18 kbps	14.7 kbps	—

### Bandwidth Calculation

Provided below is the formula to find out the amount of bandwidth required for VoIP communications:

**Required Bandwidth**

= (No. of Fax Machines × Required Bandwidth for the G.711 codec) +  
 [(16 - No. of Fax Machines) × Required Bandwidth for Voice Communication]

#### Example

Consider the following case as an example:

- Communication: via LAN
- No. of Fax Machines: 2
- G.711 Packet Sending Interval: 20 ms (requiring 87.2 kbps per channel)
- G.729A Packet Sending Interval for Voice Communication: 20 ms (requiring 31.2 kbps per channel)

In this case, the required bandwidth will be as follows:

**Required Bandwidth**

= (2 × 87.2) + [(16 - 2) × 31.2]  
 = 611.2 (kbps)

### 8.2.3 Bandwidth Assessment

Therefore, inform your network administrator and make sure that the network can support a bandwidth of 611.2 kbps even when the network is under conditions of maximum traffic.

#### Note

It is recommended that all cards on a VoIP network have the same packet sending interval.

#### Additional Information

As described above, it is possible to control the required bandwidth by selecting a certain combination of codec and packet sending interval. However, it is also possible to control required bandwidth by limiting the number of available virtual VoIP channels.

The V-IPGW4 card supports a total of 8 ports, each having 2 separate channels. By disabling some of the ports, you can reduce the bandwidth required for VoIP communications.

#### To limit the number of VoIP channels:

Set the status of the ports you wish to disable (starting from the highest-numbered port) to **OUS**.

For example, if you wish to use only 10 of the available 16 virtual VoIP channels (i.e., disable 6 channels), set ports 8, 7, and 6 to **OUS** as shown below:

Gateway Port Property				
	Shelf	Slot	Port	Connection
	Virtual	32	1	INS
	Virtual	32	2	INS
	Virtual	32	3	INS
	Virtual	32	4	INS
	Virtual	32	5	INS
	Virtual	32	6	OUS
	Virtual	32	7	OUS
	Virtual	32	8	OUS

In this case, the equation for bandwidth calculation, based on the previous example, will change as follows:

#### Required Bandwidth

$$\begin{aligned} &= (\text{No. of Fax Machines} \times \text{Required Bandwidth for the G.711 codec}) + \\ &[(\mathbf{10} - \text{No. of Fax Machines}) \times \text{Required Bandwidth for Voice Communication}] \\ &= (2 \times 87.2) + [(\mathbf{10} - 2) \times 31.2] \\ &= 424 \text{ (kbps)} \end{aligned}$$

## 8.2.4 Virtual VoIP Gateway Card Specifications

For details about the RFCs and protocols for the V-IPGW4 card, refer to the following specifications.

ITU-T	H.323
	H.225.0
	H.245
Codecs	G.711 (a-law and $\mu$ -law)
	G.729A
Voice Operations	Echo Cancellation (48 ms)
	Jitter Buffer (200 ms)
	VAD (Voice Activity Detection) <sup>*1</sup>
	PLC (Packet Loss Concealment)
DTMF Relay	Inband/Outband (RFC2833)/Outband (H.245)
Fax Relay	G.711 Inband/T.38
Protocol/Function	RTP
	RTCP

\*1 VAD is only available for codec G.711.

## 8.3 SIP Trunks

This section provides information on using SIP trunks with the PBX.

### 8.3.1 IP Telephony Service

The Virtual 4-Channel SIP Trunk Card (V-SIPGW4) is a virtual trunk card which is designed to be easily integrated into an Internet Telephony Service provided by an ITSP (Internet Telephony Service Provider).

As a major SIP Provider, an ITSP provides its telephony service partly through the conventional telephone network (e.g., ISDN and Mobile), which is fee-based. An ISP (Internet Service Provider), another major SIP Provider, does not provide telephone connection itself. However, providing its users with Internet access, an ISP provides voice communication on the Internet for free. In this way, with VoIP technology based on the SIP protocol, the cost of voice communication can be much cheaper than conventional telephone networks. A maximum of 16 V-SIPGW4 cards can be installed to the virtual slots of the PBX. The channel capacity of the card allows users to connect to up to 32 different ISP/ITSPs.

### V-SIPGW4 Connection Outline

The following diagram illustrates a simple VoIP network connecting the V-SIPGW4 card to the Internet.

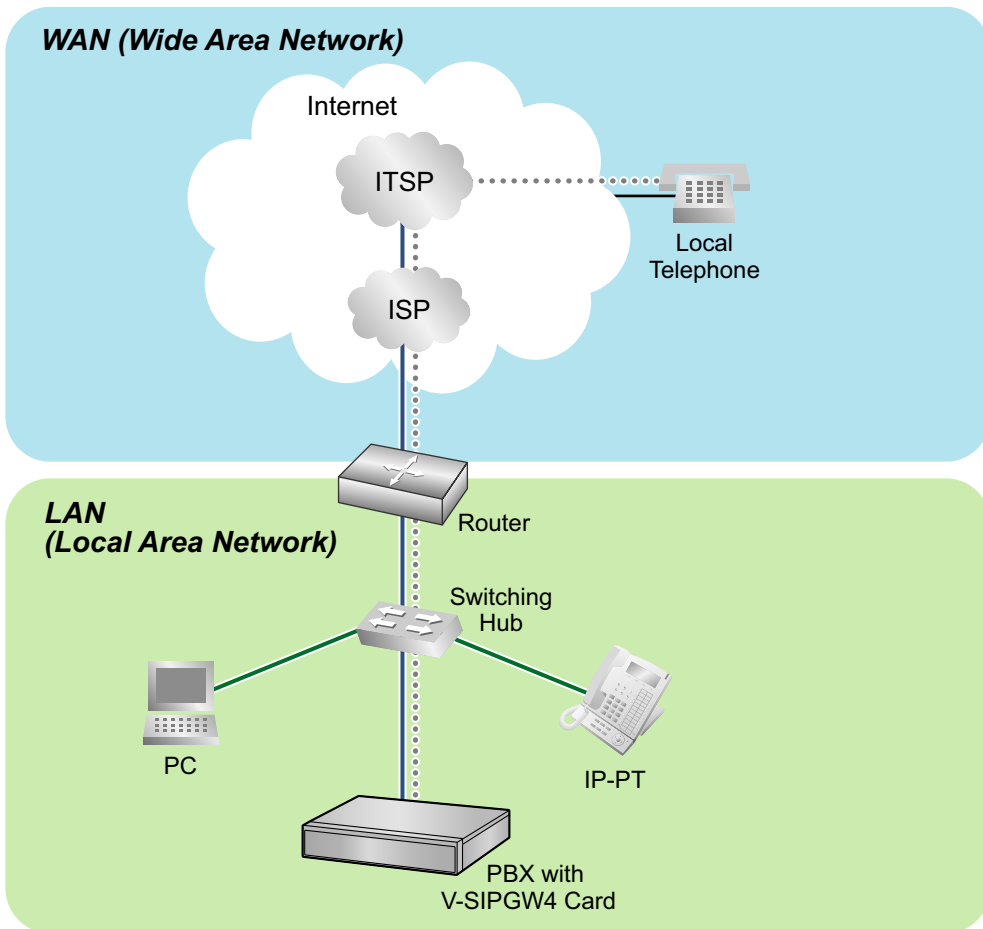

#### Requirements for Internet Telephony Service

- You need to subscribe with an ISP for Internet connection.

- You need to subscribe with an ITSP for telephone connection. The ISP and ITSP may be part of the same company.

**Note**

- VoIP communication using the V-SIPGW4 card may deteriorate depending on the ITSP being used.
- VoIP communication using the V-SIPGW4 card may deteriorate depending on the network conditions.

## DNS (Domain Name System)

A DNS server normally provides the name resolution service for your PC. As domain names are alphabetic, they are easier to remember. The Internet, however, is based on IP addresses. Therefore, every time a domain name is used, a DNS server must translate the name into the corresponding IP address, and vice versa. For example, the domain name *www.example.com* may be translated to *192.0.34.166*. If one DNS server does not know how to translate a particular domain name, it asks another one, and so on, until the correct IP address is returned.

## NAT Traversal

When NAT/NAPT (Network Address Port Translation) is enabled, the router translates a local IP address from the PBX into a global IP address. However, the router with NAT enabled does not translate local IP addresses stored in SIP messages into global IP addresses.

Therefore, the address which the SIP Server recognises as the destination IP address to reply to is actually the local IP address of the PBX, not the global IP address of the router. Therefore, if the SIP Server receives a SIP message from the PBX and sends a message back to the PBX using the address stored in the SIP message, the packet information will not reach the PBX.

STUN Servers function to solve the global IP address problem under certain NAT conditions, for example, in case of full duplex communication. A STUN Server, used alongside the SIP Server, finds out the global IP address of the router with NAT enabled. With the STUN feature enabled, the packet information sent by the SIP Server is able to "traverse" NAT and reach the PBX.

The settings can be configured to specify whether to enable the NAT Traversal feature for each ISP/ITSP. In addition, the NAT Traversal method can be selected from "STUN" and "Fixed IP Address". For details, refer to "9.8 PBX Configuration—[1-1] Configuration—Slot—V-SIPGW—Shelf Property" in the PC Programming Manual.

The V-SIPGW4 card may require the NAT Traversal feature to be enabled to connect to the WAN via a router. The following diagram illustrates how VoIP communication is enabled between the V-SIPGW4 card and the SIP Server (SIP Receiver) via a router with NAT enabled.

### 8.3.1 IP Telephony Service

---

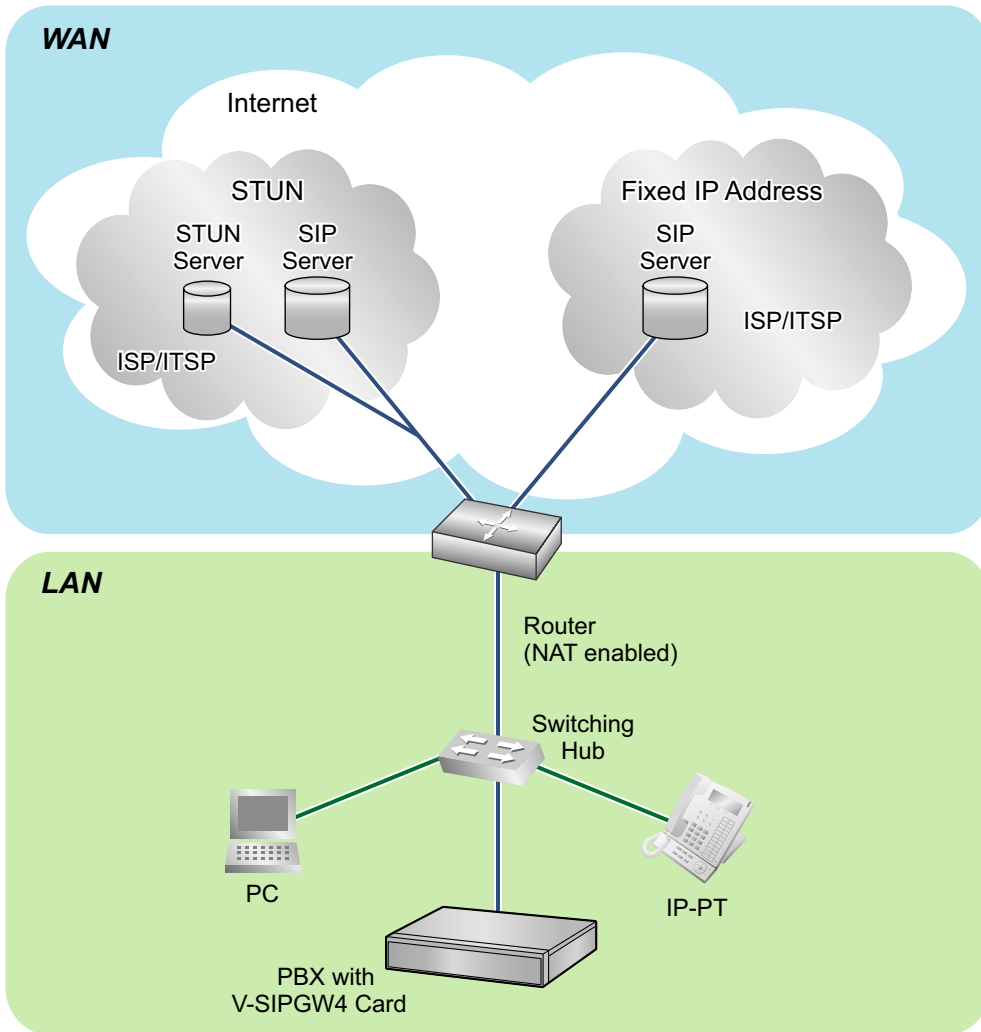

#### **Note**

- If an ISP/ITSP uses a device such as SBC (Session Border Controller), you may not have to enable the NAT Traversal feature.
- A STUN Server is supplied by an ISP/ITSP, and not included with the PBX.

## 8.3.2 SIP Requirements

### Port Requirements

#### Required Ports for Each Channel

When configuring a router with NAT enabled, you need to secure a certain number of ports for each SIP and RTP/RTCP channel. For RTP/RTCP, the number of required ports is double the number of activated SIP trunks (Ch). For SIP signalling, the number of required ports is always one regardless of the number of activated SIP trunks (Ch).

<Example>

If 4 SIP trunk channels are activated, you need the following number of ports:

Protocol Type	Required Port
RTP	4
RTCP	4
SIP	1
Total	9

### Firewall Requirements

If the VoIP network contains a firewall, the firewall must be configured appropriately to allow VoIP packets to pass through the network without being blocked by filtering. For the protocols and port numbers that the PBX uses for VoIP communication, refer to "8.5 Port Security".

The ports for which you need to configure the firewall may vary depending on the network conditions.

For more information, consult your network administrator.

## 8.3.3 Router Requirements

- **Port Forwarding:**  
It may be necessary to set the NAT router so that it forwards the incoming packets to the IP address of the V-SIPGW4 card if all of the following conditions are met:
  - the PBX uses a STUN server;
  - a V-SIPGW4 card is located under a NAT router;
  - incoming packets are routed to a SIP Client port or NAT Voice (RTP) UDP port indicated in "8.5 Port Security".
- **SIP-NAT Feature:**  
When a V-SIPGW4 card is located under a NAT router that supports the SIP-NAT feature<sup>1</sup>, it is recommended to disable this feature.

<sup>1</sup> When NAT is enabled, the router translates the IP address stored in the IP header and the port number stored in the UDP header. When SIP-NAT is enabled, the router also translates the IP address and port number stored in SIP messages.

## 8.3.4 Bandwidth Requirements

When using the V-SIPGW4 card, you must ensure that the WAN has enough bandwidth to support VoIP communications. Refer to the table below and ensure that the sum of the required bandwidth for each channel is smaller than the amount the WAN (e.g., ADSL network) can provide.

### 8.3.4 Bandwidth Requirements

---

Note that the amount in the table is only a guide. Subscribe to a network that has enough bandwidth. If the amount of bandwidth required for VoIP communications is larger than what the network can accommodate, speech quality will be compromised.

#### Required Bandwidth for Each Channel

The required bandwidth depends on what combination of codecs and packet sending interval is used. Keep in mind the following points about the type of codec and packet sending interval, in terms of the speech quality:

- The speech quality of the codecs varies as follows: G.711 (High), G.729A (Low)
- The shorter the packet sending interval, the higher the speech quality.
- The higher the speech quality the V-SIPGW4 card provides, the more bandwidth the WAN requires.

Codec	Packet Sending Interval					
	10 ms	20 ms	30 ms	40 ms	50 ms	60 ms
G.711	110.4 kbps	87.2 kbps	79.5 kbps	75.6 kbps	73.3 kbps	71.7 kbps
G.729A	54.4 kbps	31.2 kbps	23.5 kbps	19.6 kbps	17.3 kbps	15.7 kbps



## 8.3.5 Virtual SIP Trunk Card Specifications

For details about the RFCs and protocols for the V-SIPGW4 card, refer to the following specifications.

Items	Specification
SIP RFCs	RFC3261 (UDP only)
	RFC3262 (PRACK)
	RFC3264 (Offer/Answer)
	RFC3311 (UPDATE)
	RFC3581 (Symmetric Response Routing/rport)
	RFC4028 (Session Timer)
Codecs	G.711 (a-law and $\mu$ -law)
	G.729A
Voice Options	Echo Cancellation (48 ms)
	Jitter Buffer (200 ms)
	VAD (Voice Activity Detection) <sup>*1</sup>
	PLC (Packet Loss Concealment)
DTMF Relay	Inband/Outband (RFC2833)/Outband (SIP INFO)
Fax Relay	G.711 Inband/T.38
Protocol/Function	RTP
	RTCP
	DNS (A/SRV)
	NAT Traversal (STUN)
	QoS (ToS field setting in IP header of RTP/RTCP)

\*1 VAD is only available for codec G.711.

## 8.4 Types of PBX Networks

This section gives an overview of the types of networks the PBX can participate in.

### 8.4.1 H.323 QSIG Network

This section gives an overview of H.323 QSIG networks.

**Image of a H.323 QSIG network:**

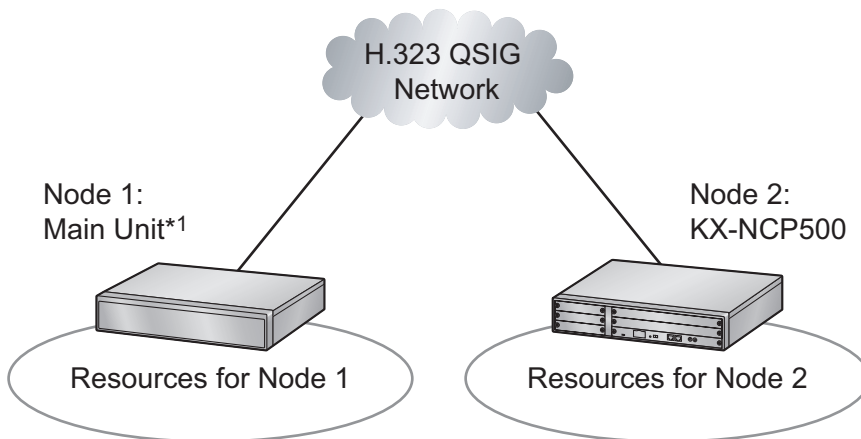

\*1 KX-NS300

### Features

- H.323 QSIG networks can include non-KX-NS300 PBXs (e.g., KX-TDE200, KX-NCP500).
- Resources are not available to extension users of other PBX without explicit configuration.

### Conditions

- PBXs in an H.323 QSIG network must be connected over a private IP network.

### Bandwidth Requirements

Refer to "8.2.3 Bandwidth Assessment".

### Required Items

- V-IPGW4: Virtual 4-Channel VoIP Gateway Card

#### Note

- The following activation key is required for enhanced QSIG network features (NDSS, Centralised Voice Mail, etc.).
  - KX-NSN002: Activation Key for QSIG Network (QSIG Network)
- For more details about H.323 QSIG networks, refer to "4.2.1 TIE Line Service" in the Feature Guide.
- For details about configuring and programming a H.323 QSIG network, refer to "◆ TIE Line Access" in the PC Programming Manual.

## 8.5 Port Security

If the VoIP network contains a firewall, the firewall must be configured appropriately to allow VoIP packets to pass through certain ports of the ports listed below without being blocked by filtering. The ports for which you need to configure the firewall may vary depending on the network conditions.

For more information, consult your network administrator.

The following table shows the PBX's ports used for IP communications. Any access to the ports not in this list is ignored.

### Port Numbers for LAN Port

Port Number	Protocol	Application	Client/Server	Changeable/ Fixed
25	TCP/UDP	SMTP	Server	Changeable
53	UDP	DNS	Server	Fixed
67	UDP	DHCP	Server	Changeable
68	UDP	DHCP	Client	Changeable
80	TCP	HTTP	Server	Changeable
123	UDP	NTP	Server	Fixed
143	TCP	IMAP	Server	Changeable
161	UDP	SNMP	Server	Changeable
443	TCP	HTTPS	Server	Changeable
465	TCP/UDP	SMTP over SSL	Server	Changeable
993	TCP	IMAP over SSL	Server	Changeable
1717	UDP	Connectionless UDP	-	Changeable
1718	TCP	Connectionless TCP	-	Changeable
1719	UDP	H.225 RAS	-	Changeable
1720	TCP	H.225 Call Signal	-	Changeable
2103	TCP	CMM	Server	Fixed
2300	TCP	Telnet-SMDR	-	Changeable
2727	UDP	MGCP <sup>1</sup>	-	Changeable
3493	TCP	UPS <sup>2</sup>	-	Fixed
3702	UDP	WSD	Server	Changeable
4560–4561	UDP	PSAP	-	Changeable
4562	UDP	SSAP	-	Changeable
5060	UDP	SIP UA (EXT)	-	Changeable
7547	TCP	CWMP	Server	Changeable
7580	TCP	HTTP	Server	Changeable

## 8.5 Port Security

Port Number	Protocol	Application	Client/Server	Changeable/ Fixed
8080	TCP	Web Maintenance Console	-	Changeable
9300	UDP	PTAP	-	Changeable
10000– 10895	TCP	H.323 Dynamic Port (H.225 Send, H.245 Send/ Receive, Connection-less [TCP] Send Port)	-	Changeable
20000	TCP	UM-VMA <sup>3</sup>	Server	Fixed
30021	TCP/UDP	FTP/FTPS	Server	Changeable
32727	UDP	MGCP <sup>1</sup> for IP-CS	-	Changeable
33090	UDP	ACS-MDW	Server	Fixed
33091				
33092				
33131				
33321	TCP	Access Point Login (Telnet)	Server	Changeable
33333	TCP	CTI 3rd Party Connection	-	Changeable
33334	TCP	CTI 1st Party Connection	-	Changeable
33478	UDP	STUN	Client	Changeable
33702	UDP	ACS-MDW (WSD)	Server	Fixed
35060	UDP	SIP UA (CO)	-	Changeable
37547	TCP	CWMP	Server	Changeable
37580	TCP	HTTPS	Server	Changeable
39300	UDP	PTAP for IP-CS	-	Changeable
40000– 40095	TCP/UDP	FTP/FTPS-Data	Server	Changeable
50000– 65535 (Ephemeral)	UDP	SNMP TRAP	Client	Fixed
	TCP/UDP	FTP	Client	
	TCP/UDP	FTP/FTPS-Data	Client	
	UDP	NTP	Client	
	UDP	DNS	Client	
	UDP	SYSLOG	Client	
	TCP/UDP	SMTP	Client	
	TCP/UDP	SMTP over SSL	Client	
	TCP/UDP	POP3	Client	

Port Number	Protocol	Application	Client/Server	Changeable/ Fixed
	TCP/UDP	ACS-MDW	Server	

\*1 Media Gateway Control Protocol. Used for call control command data and LCD/LED data transmission.

\*2 Used by UPS daemon.

\*3 Used by Unified Messaging.

## Port Numbers for Optional DSP Card

Port Number	Protocol	Application	Client/Server	Changeable/ Fixed
12000– 13535	UDP	RTP/RTCP	-	Changeable
16000– 18047	UDP	RTP/RTCP for NAT traversal	-	Changeable



---

## **Section 9**

# **Appendix**

*This section provides information about PBX Region Suffix Codes and Areas, System Prompt Languages.*

## 9.1 PBX Region Suffix Codes and Areas

According to the following table, select the appropriate Suffix Code and Area for your PBX to localise PBX settings to your location.

**For KX-NS300**

Model Name	Area Code
KX-NS300BX	BX
KX-NS300SX	BX
KX-NS300ML	-
KX-NS300XE	SG



## 9.2 System Prompt Languages

### Note

- The following abbreviations are used in the language file names:
  - UK: United Kingdom
  - US: United States
  - LA: Latin America
  - CA: Canada
  - BR: Brazil
- No. 1 is set by default. For details, see "24.4 UM Configuration—[5-4] System Parameters—Parameters—Prompt Setting—Prompt Setting" in the PC Programming Manual.

### System prompt languages stored in the System Memory

<b>KX-NS300 Suffix</b>	<b>BX</b>	<b>SX</b>	<b>ML</b>	<b>XE</b>
No. 1 (Primary)	US-English	US-English	US-English	US-English
No. 2	French	French	Mandarin	Mandarin
No. 3	-	-	Taiwan Mandarin	Taiwan Mandarin
No. 4	-	-	Cantonese	Cantonese
No. 5	-	-	-	-
No. 6	-	-	-	-
No. 7	-	-	-	-
No. 8	-	-	-	-

## 9.2 System Prompt Languages

---



**For Future Reference**

Please print, record, and retain the following information for future reference.

**Note**

The serial number of this product can be found on the label affixed to the unit. You should record the model number and the serial number of this unit as a permanent record of your purchase to aid in identification in the event of theft.

MODEL NO.	_____
SERIAL NO.	_____
DATE OF PURCHASE	_____
NAME OF DEALER	_____
DEALER'S ADDRESS	_____ _____ _____
DEALER'S TEL. NO.	_____

**Panasonic System Networks Co., Ltd.**

1-62, 4-chome, Minoshima, Hakata-ku, Fukuoka 812-8531, Japan

Web Site: <http://www.panasonic.net/>

**Copyright:**

This material is copyrighted by Panasonic System Networks Co., Ltd., and may be reproduced for internal use only. All other reproduction, in whole or in part, is prohibited without the written consent of Panasonic System Networks Co., Ltd.

© Panasonic System Networks Co., Ltd. 2014