

# Panasonic®

## User Manual Hybrid IP-PBX

---



Model No. **KX-NS300**

โปรเฟสชั่นแนล พี. เอ. บี. เอ็กซ์.

30/270 ซอยนวมินทร์ 80 แขวงนวลจันทร์ เขตบึงกุ่ม กรุงเทพฯ 10230

Hotline : 084-920-5065 Tel : 02-519-1718 , 02-107-3057

E.Mail : info@pfpbx.com , jirasak\_service@hotmail.com

www.pfpbx.com

Thank you for purchasing this Panasonic product.

Please read this manual carefully before using this product and save this manual for future use.

In particular, be sure to read "1.1.1 For Your Safety (Page 14)" before using this product.

**KX-NS300: PFMPR Software File Version 001.00000 or later**

# Feature Highlights

## IP Communication

This PBX supports IP communication using a variety of IP telephones, such as the KX-NT300/KX-NT500 series with Self Labelling and/or Bluetooth® wireless headsets, Panasonic IP Softphones, SIP phones, and SIP-CS compatible Portable Stations.

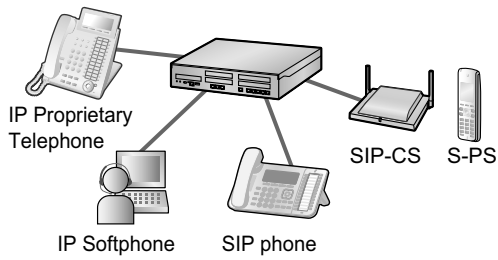

Consult your dealer

## Easy Operation

If you are using a certain Panasonic telephone that is equipped with a Navigator Key/Jog Dial and a display, it helps you to access the desired feature easily. Also, you will be informed of the arrival of an incoming call or a message waiting by the lamp if it is equipped.

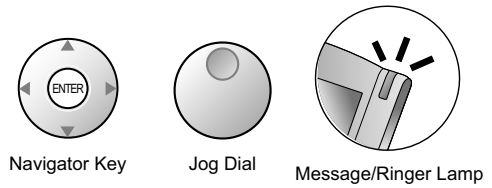

1.1 Before Operating the Telephones (Page 14)

## Remote Office

This PBX supports the use of SIP phones connected from a remote office over an IP network through an SBC (session border controller). SIP phones can be set up by simply connecting the phones to the LAN at the remote office.

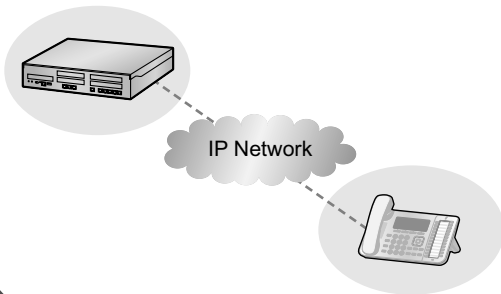

Consult your dealer

## Cellular Phone Features

This PBX supports the use of cellular phones with the PBX. Cellular phones can make and receive calls as if they were registered extensions.

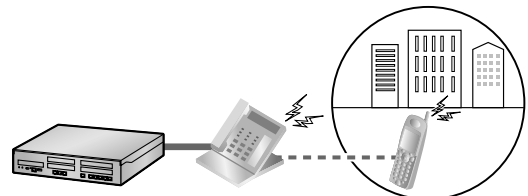

1.15 Cellular Phone Features (Page 261)

**Wireless System**

This PBX optionally supports a Portable Station (PS) system. PSs can be used in the PBX with other wired telephones.

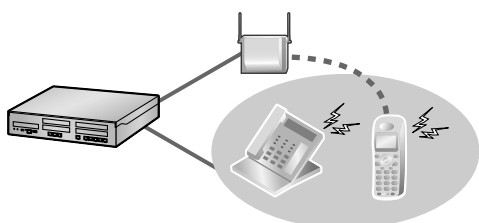

1.9.12 Using Your PS or S-PS in Parallel with a Wired Telephone (Wireless XDP Parallel Mode) (Page 210)

**Built-in Unified Messaging**

You can set incoming calls to be redirected to your mailbox to let callers leave voice messages when you are unable to answer the phone. You can access your mailbox to listen to the messages when you are away from the office as well.

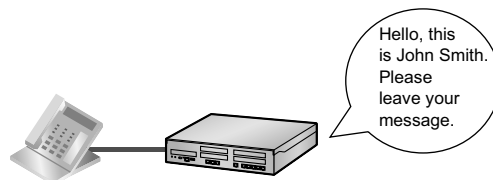

1.8 Using the Unified Messaging Features (Page 137)

**Call Centre**

This PBX offers a built-in Call Centre feature called Incoming Call Distribution (ICD) Group. Incoming calls to an ICD Group can be queued or redirected to a preprogrammed destination, answered in order of priority and monitored by a supervisor extension.

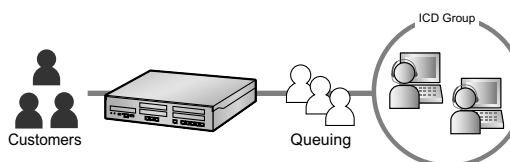

1.10 Utilising the Call Centre (Page 214)

**Communication Assistant (CA)**

CA Client users can connect to the PBX without using an external server. CA Client users can make calls by clicking in a phonebook on their PC, as well as use many other features.

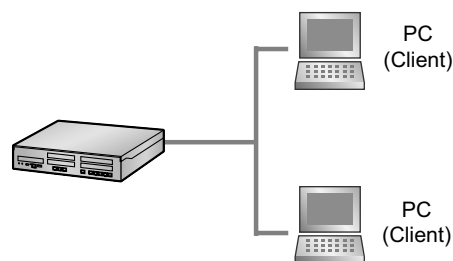

Consult your dealer

### CA Call Accounting

This application can calculate call cost estimates and track call activity for calls that are made through the PBX. Installing the CA Call Accounting web server software allows you to access CA Call Accounting from any PC by using a web client. You can sort and view, print, or export call information with the web client. In addition, reports can be created based on exported data.

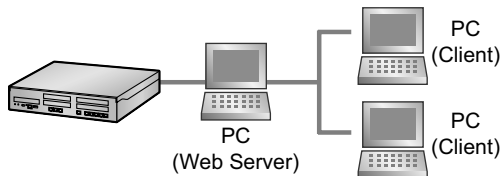

Consult your dealer

### In This Manual,

- The following abbreviations are used:
  - APT → Analogue Proprietary Telephone
  - Display PT → Proprietary Telephone with a Display
  - DPT → Digital Proprietary Telephone
  - IP-PT → IP Proprietary Telephone
  - PS → Portable Station
  - PT → Proprietary Telephone
  - S-PS → SIP-CS compatible Portable Station
  - SIP extension/SIP Extn. → Extensions of the PBX which uses Session Initiation Protocol for communication.
  - SLT → Single Line Telephone
- "PT" is used as a generic term to represent IP-PT, DPT, APT and Display PT.
- The suffix of each model number (e.g., KX-NS300**BX**) is omitted.
- The following icons are used frequently.



Hints



Conditions

## Functional Limitation

Depending on the PBX's software version, these features may not function. For details about which versions support these features, consult your dealer.

- Features are provided by ISDN services

### [Example]

#### 1.4.1 Transferring a Call (Call Transfer)

◆◆ Transferring a Call Using the ISDN Service (Call Transfer [CT]—by ISDN)

#### 1.4.5 Multiple Party Conversation

◆◆ Adding a Third Party during a Conversation Using the ISDN Service (Three-party Conference [3PTY]—by ISDN)

## Notice

- This PBX supports SIP (Session Initiation Protocol) phones. However, some PBX features may not be available for SIP phones, depending on your telephone type.
- Under power failure conditions, the connected telephones may not operate. Please ensure that a separate telephone, not dependent on local power, is available for emergency use.
- Prior to connection of this product, please verify that the intended operating environment is supported. Satisfactory performance cannot be guaranteed for the following:
  - interoperability and compatibility with all devices and systems connected to this product
  - proper operation and compatibility with services provided by telecommunications companies over connected networks

## NOTES

- Some optional hardware, software, and features are not available in some countries/areas, or for some PBX models. Please consult your certified Panasonic dealer for more information.
- This manual provides basic information on how you can access commonly used PBX functions with proprietary telephones (PTs), single line telephones (SLTs), portable stations (PSs), SIP phones, SIP-CS compatible Portable Stations (S-PSs), and DSS Consoles. For detailed information about each feature or setting, consult your dealer.
- In this manual, several kinds of PTs appear, as follows:
  - IP Proprietary Telephone (IP-PT)
  - Digital Proprietary Telephone (DPT)
  - Analogue Proprietary Telephone (APT)
  - Proprietary Telephone with a Display (Display PT)"PT" is used as a generic term to represent all of these PTs. If a PBX feature only supports specific PTs, such as IP-PTs, the available telephone types are clearly indicated.
- IP-PTs/SIP extensions may become busy and you may not be able to make or receive calls, depending on the network status.
- The contents of this manual apply to PBXs with a certain software version, as indicated on the cover of this manual. To confirm the software version of your PBX, consult your dealer.
- Product specifications are subject to change without notice.
- The preset melodies in this product are used with permission of © 2010 Copyrights Vision Inc.

## Notes for SIP Phone and S-PS Users

Before using a SIP phone or S-PS, please read the following notes.

### For All SIP phone and S-PS users

A tone may not be heard during an operation depending on the type of SIP phone or S-PS being used. The following operation is an example. However, for KX-UT series SIP phones, tone may be able to be heard depending on the system settings. For details, consult your dealer.

[Example]

To use an account code (Account Code Entry)

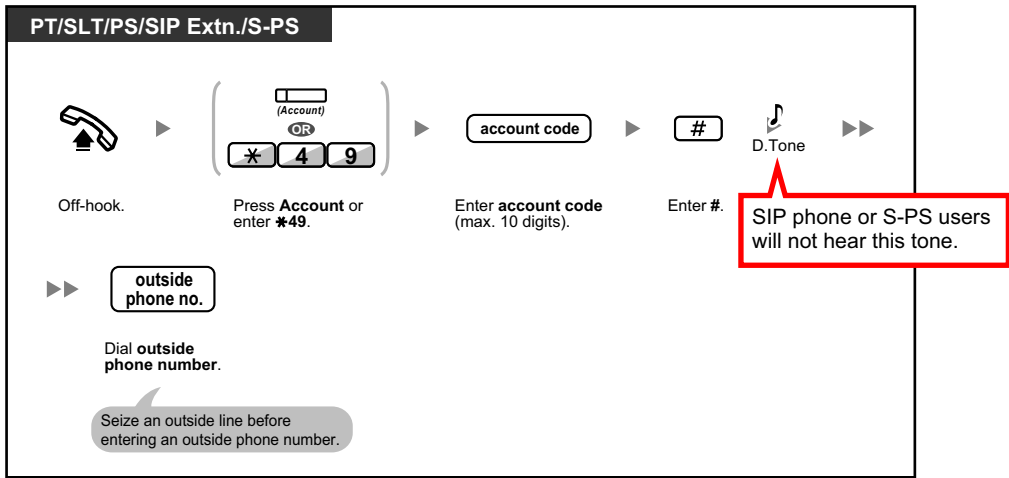

For KX-UT series SIP phone and S-PS users

- a. Operations that use feature numbers are limited. Also, flexible buttons are only available for S-PSs and certain KX-UT series SIP phone models. Refer to the telephone types displayed at the top left of each operation.
- b. A maximum of 32 digits can be input on a KX-UT series SIP phone at one time, including feature numbers, etc.
- c. To execute certain operations, you may be required to press the ENTER button on a KX-UT series SIP phone or the CALL button (soft button) on an S-PS during the operation. The following 5 operations are examples.

[Examples]

To select an idle outside line automatically

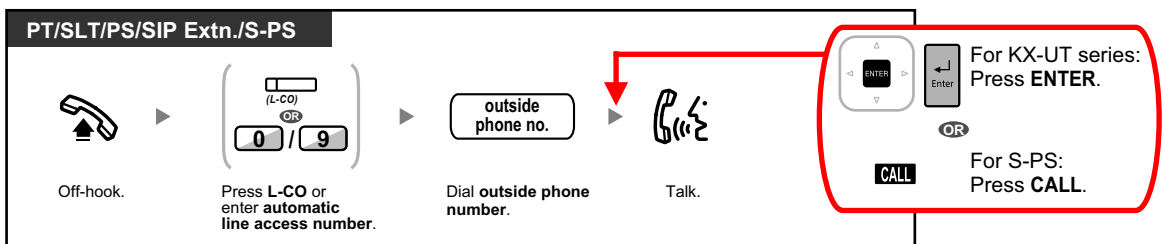

### To call with a verification code

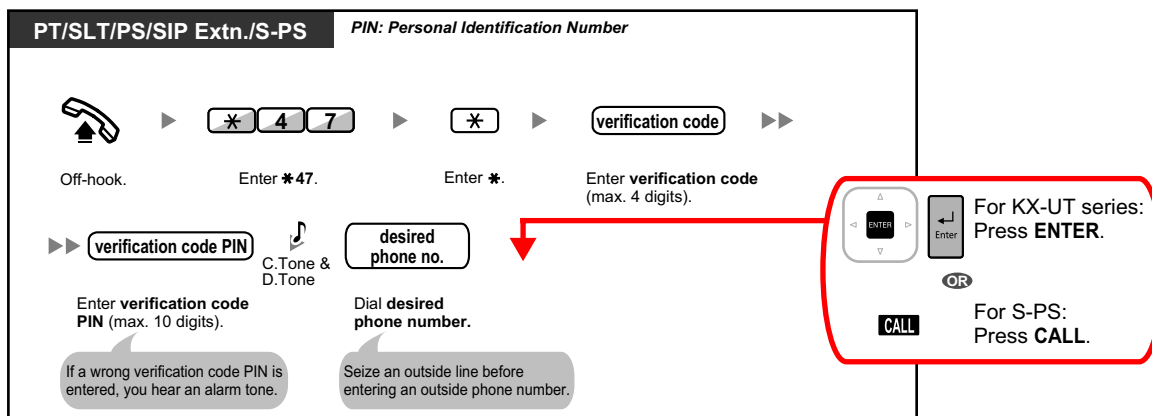

### To transfer to an outside party using the PBX service

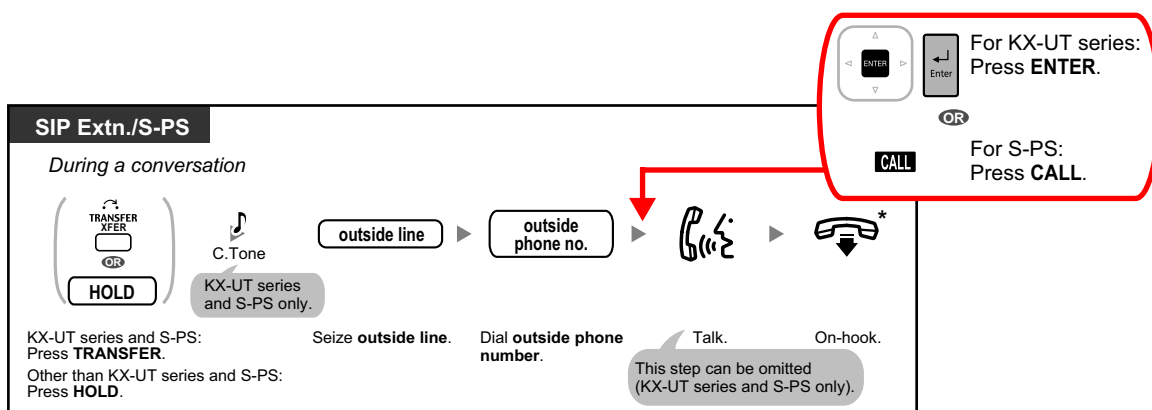

### To establish a conference call

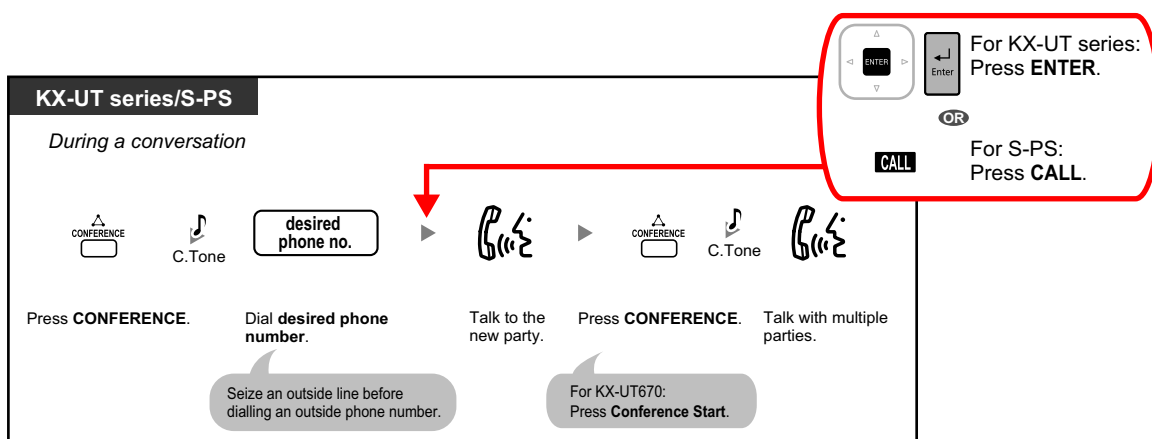

To set/cancel Call Forwarding

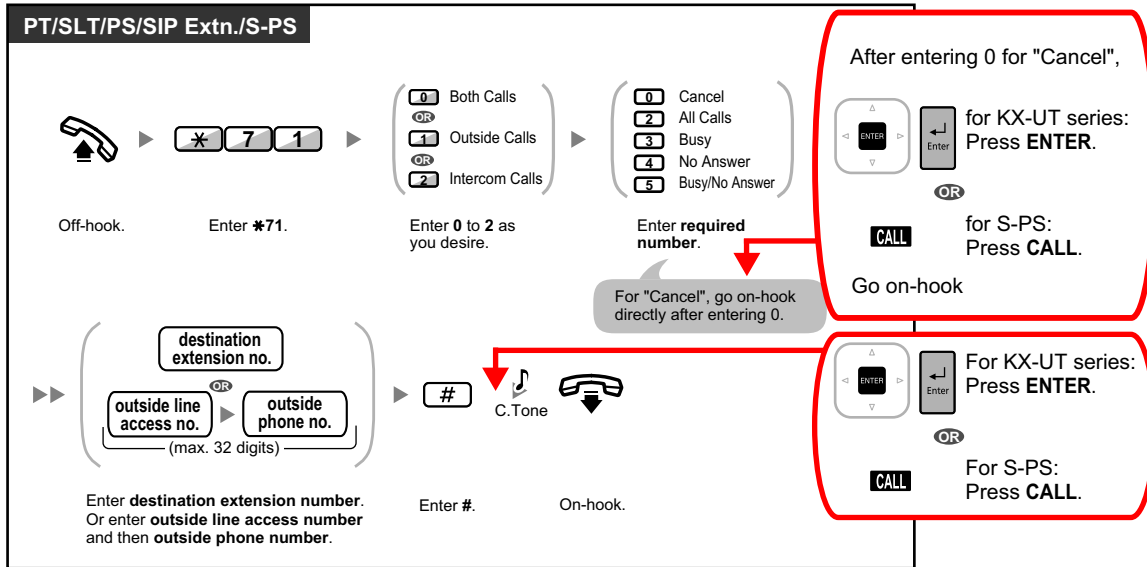

For non-KX-UT series SIP phone users

- The following features are available for SIP phone users:
  - Making calls
  - Answering calls
  - Holding calls
  - Transferring calls (You cannot go on-hook before the transferred party answers.)
- The available operations using feature numbers are limited. Refer to the telephone types displayed at the top left of each operation.
- The tones listed in "5.4.1 What is This Tone?" are not available for SIP phone users. Tones or the tone types may vary depending on the type of telephone being used. For example, when you put a call on hold, a specific tone for the SIP phone may be heard, or no tone may be heard.
- Any number pressed while hearing a Busy/DND/Reorder tone, such as the feature number to activate Automatic Callback Busy, will be ignored.
- The operations for SIP phones may differ from the steps in this manual, and may vary depending on the type of telephone being used.
- To execute an operation, some SIP phones may require that the OK button is pressed after pressing all the buttons of the operation.

Notes for KX-WT115 PS Users

The operation and display of the KX-WT115 may differ from KX-TCA series PSs. For example, when the KX-WT115 is not answered while using it in parallel with a wired telephone, the display of incoming call log is different from that of the display of KX-TCA series PSs.

Notes for KX-NT300 Series, KX-NT500 Series, KX-UT Series, and S-PS Users

If the primary PBX to which your telephone is connected fails, the extension may automatically switch its connection to a secondary PBX.

- The time required to switch to the secondary PBX or back to the primary PBX is different depending on the type of your telephone.
- When the extension switches its connection to the secondary PBX, your call will be disconnected if you are on a call.



- Even if the primary PBX becomes available again, your telephone will not reconnect to it if you are on a call.
- For KX-NT300 series and KX-NT500 series users, if background music (BGM) is being played through your telephone while it is connected to the secondary PBX, it will not reconnect to the primary PBX when it becomes available.

## Notes for KX-NT543, KX-NT546, and KX-NT560 IP-PT Users

- While using a KX-NT543, KX-NT546, or KX-NT560 IP-PT in ECO mode, IP network transmission speed is relatively slow and the secondary Ethernet port cannot be used. To disable ECO mode, consult your dealer.

## Trademarks

- Microsoft and Outlook are either registered trademarks or trademarks of Microsoft Corporation in the United States and/or other countries.
- The Bluetooth® word mark and logos are registered trademarks owned by Bluetooth SIG, Inc., and any use of such marks by Panasonic Corporation is under license.
- All other trademarks identified herein are the property of their respective owners.
- Microsoft product screen shot(s) reprinted with permission from Microsoft Corporation.

## Open Source Software

This product uses Open Source Software. For details, click the Information button in Web Maintenance Console.

# Table of Contents

<b>1</b>	<b>Operation</b>	<b>13</b>
1.1	<b>Before Operating the Telephones</b>	<b>14</b>
1.1.1	For Your Safety	14
1.1.2	Important Safety Instructions	19
1.1.3	Data Security	20
1.1.4	Before Operating the Telephones	21
1.2	<b>Making Calls</b>	<b>31</b>
1.2.1	Basic Calling	31
1.2.2	Easy Dialling	36
1.2.3	Redial	39
1.2.4	When the Dialed Line is Busy or There is No Answer	40
1.2.5	Accessing the ISDN Service (ISDN Service Access)	48
1.2.6	Alternating the Calling Method (Alternate Calling—Ring/Voice)	49
1.2.7	Calling without Restrictions	50
1.2.8	To Access Another Party Directly from Outside (Direct Inward System Access [DISA])	51
1.2.9	Setting Your Telephone from Another Extension or through DISA (Remote Setting)	54
1.3	<b>Receiving Calls</b>	<b>55</b>
1.3.1	Answering Calls	55
1.3.2	Answering Hands-free (Hands-free Answerback)	56
1.3.3	Answering a Call Ringing at Another Telephone (Call Pickup)	57
1.3.4	Answering a Call via an External Speaker (Trunk Answer From Any Station [TAFAS])	59
1.3.5	Using the ANSWER/RELEASE Button	60
1.3.6	Identifying Malicious Calling Parties (Malicious Call Identification [MCID])	62
1.4	<b>During a Conversation</b>	<b>63</b>
1.4.1	Transferring a Call (Call Transfer)	63
1.4.2	Holding a Call	69
1.4.3	Talking to Two Parties Alternately (Call Splitting)	75
1.4.4	Answering Call Waiting	77
1.4.5	Multiple Party Conversation	83
1.4.6	Mute	94
1.4.7	Letting Other People Listen to the Conversation (Off-hook Monitor)	95
1.4.8	Using the Headset (Headset Operation)	96
1.5	<b>Using a PDN/SDN Button</b>	<b>98</b>
1.5.1	Primary Directory Number (PDN)/Secondary Directory Number (SDN) Extension	98
1.6	<b>Before Leaving Your Desk</b>	<b>102</b>
1.6.1	Forwarding Calls	102
1.6.2	Showing a Message on the Caller's Telephone Display (Absent Message)	112
1.6.3	Preventing Other People from Using Your Telephone (Extension Dial Lock)	114
1.6.4	Using Voice Messaging (Built-in Simplified Voice Message [SVM])	116
1.7	<b>Making/Answering an Announcement</b>	<b>127</b>
1.7.1	Paging	127
1.7.2	Answering/Denying a Paging Announcement	129
1.7.3	Making a Conference Group Call	130
1.8	<b>Using the Unified Messaging Features</b>	<b>137</b>
1.8.1	What is the Unified Messaging system?	137
1.8.2	Logging in to and Configuring Your Mailbox	139
1.8.3	Message Playback and Related Features	149
1.8.4	Sending Messages	157

1.8.5	Transferring Calls .....	167
1.8.6	Other Features .....	175
1.8.7	Quick Reference .....	192
<b>1.9</b>	<b>Setting the Telephone According to Your Needs .....</b>	<b>195</b>
1.9.1	Setting the Alarm (Timed Reminder) .....	195
1.9.2	Refusing Incoming Calls (Do Not Disturb [DND]) .....	197
1.9.3	Receiving Call Waiting (Call Waiting/Off-hook Call Announcement [OHCA]/Whisper OHCA) .....	201
1.9.4	Displaying Your Telephone Number on the Called Party and Caller's Telephone (Calling/Connected Line Identification Presentation [CLIP/COLP]) .....	202
1.9.5	Preventing Your Telephone Number Being Displayed on the Caller's Telephone (Connected Line Identification Restriction [COLR]) .....	203
1.9.6	Preventing Your Number Being Displayed on the Called Party's Telephone (Calling Line Identification Restriction [CLIR]) .....	204
1.9.7	Preventing Other People from Joining Your Conversation (Executive Busy Override Deny) .....	205
1.9.8	Turning on the Background Music (BGM) .....	206
1.9.9	Protecting Your Line against Notification Tones (Data Line Security) .....	207
1.9.10	Checking the Time Service Status .....	208
1.9.11	Setting the Paralleled Telephone to Ring (Paralleled Telephone) .....	209
1.9.12	Using Your PS or S-PS in Parallel with a Wired Telephone (Wireless XDP Parallel Mode) .....	210
1.9.13	Using Your phone in Parallel with a Wired Telephone (One-numbered extension) .....	211
1.9.14	Clearing Features Set at Your Extension (Extension Feature Clear) .....	212
<b>1.10</b>	<b>Utilising the Call Centre .....</b>	<b>214</b>
1.10.1	Leaving an Incoming Call Distribution Group (Log-in/Log-out, Wrap-up) .....	214
1.10.2	Monitoring and Controlling the Call Status of an Incoming Call Distribution Group (Incoming Call Distribution Group Monitor) .....	217
1.10.3	Forwarding a Waiting Call (Manual Queue Redirection) .....	220
<b>1.11</b>	<b>Using User-supplied Equipment .....</b>	<b>221</b>
1.11.1	If a Doorphone/Door Opener is Connected .....	221
1.11.2	If an External Relay is Connected .....	223
1.11.3	If an External Sensor is Connected .....	224
1.11.4	If a Host PBX is Connected .....	225
1.11.5	If a Voice Processing System is Connected .....	226
<b>1.12</b>	<b>Administrative Features .....</b>	<b>233</b>
1.12.1	Using the Telephones in a Hotel-type Environment (Hospitality Features) .....	233
1.12.2	Recording Information Using Preprogrammed Messages (Printing Message) .....	240
<b>1.13</b>	<b>Exchanging the Settings between Extensions .....</b>	<b>241</b>
1.13.1	Walking Extension .....	241
1.13.2	Enhanced Walking Extension .....	242
<b>1.14</b>	<b>Using a Telephone with a Display .....</b>	<b>244</b>
1.14.1	Using the Call Log .....	244
1.14.2	Using the Directories .....	248
1.14.3	Accessing System Features (System Feature Access) .....	256
1.14.4	Self Labelling (KX-NT366/KX-NT553/KX-NT556/KX-NT560/KX-UT248/KX-UT670 only) .....	258
<b>1.15</b>	<b>Cellular Phone Features .....</b>	<b>261</b>
1.15.1	Cellular Phone Features .....	261
<b>2</b>	<b>Manager Operation .....</b>	<b>265</b>
<b>2.1</b>	<b>Control Features .....</b>	<b>266</b>
2.1.1	Extension Control .....	266
2.1.2	Time Service Mode Control .....	267

2.1.3	Restriction Level Control (Dial Tone Transfer) .....	269
2.1.4	Turning on the External Background Music (BGM) .....	270
2.1.5	Recording Outgoing Messages (OGM) .....	271
2.1.6	Allowing Users to Seize an Unavailable Outside Line (Trunk Busy Out) .....	273
2.1.7	Releasing Network Direct Station Selection (NDSS) Monitor .....	274
<b>2.2</b>	<b>Configuring Unified Messaging Features .....</b>	<b>275</b>
2.2.1	System Manager Features .....	275
2.2.2	Message Manager Features .....	288
<b>3</b>	<b>Customising Your Phone &amp; System .....</b>	<b>305</b>
<b>3.1</b>	<b>Customising Your Phone (Personal Programming) .....</b>	<b>306</b>
3.1.1	Customising Your Phone (Personal Programming) .....	306
3.1.2	Settings on the Programming Mode .....	308
3.1.3	Customising the Buttons .....	318
<b>3.2</b>	<b>System Programming Using Web Maintenance Console .....</b>	<b>323</b>
3.2.1	User Programming .....	323
<b>4</b>	<b>Customising Extensions and the System—for Managers .....</b>	<b>349</b>
<b>4.1</b>	<b>Manager Programming .....</b>	<b>350</b>
4.1.1	Programming Information .....	350
4.1.2	Manager Programming .....	351
4.1.3	Supervisory Monitor (ACD) Control .....	353
<b>5</b>	<b>Appendix .....</b>	<b>357</b>
<b>5.1</b>	<b>List of Operations by Telephone Type .....</b>	<b>358</b>
5.1.1	List of Operations by Telephone Type .....	358
<b>5.2</b>	<b>Troubleshooting .....</b>	<b>366</b>
5.2.1	Troubleshooting .....	366
<b>5.3</b>	<b>Feature Number Table .....</b>	<b>370</b>
5.3.1	Feature Number Table .....	370
<b>5.4</b>	<b>What is This Tone? .....</b>	<b>381</b>
5.4.1	What is This Tone? .....	381

---

# **Section 1**

## **Operation**

*This section shows you step by step how to use each feature. Read this chapter to become familiar with the many useful features of this PBX.*

# 1.1 Before Operating the Telephones

## 1.1.1 For Your Safety

To prevent personal injury and/or damage to property, be sure to observe the following safety precautions.

The following symbols classify and describe the level of hazard and injury caused when this unit is operated or handled improperly.



This notice means that misuse could result in death or serious injury.



This notice means that misuse could result in injury or damage to property.

The following types of symbols are used to classify and describe the type of instructions to be observed.



This symbol is used to alert users to a specific operating procedure that must not be performed.



This symbol is used to alert users to a specific operating procedure that must be followed in order to operate the unit safely.



## WARNING

### For All Telephone Equipment



- Do not allow rain to fall on the product or expose the product to moisture. Do not let water, oils, or other liquids to splash onto the product. Such conditions can lead to fire or electric shock, and may impair the performance of the product.
- Do not place the product on an unstable or uneven surface. If the product were to fall over, it may cause injury or damage to the product.
- Do not allow anything to rest on the power cord. Do not locate the product where the power cord may be stepped on or tripped on.
- Do not supply power to a combination of devices that exceeds the total rated capacity of the wall outlets or extension cables used. If outlets, power strips, extension cords, etc. are used in a manner that exceeds their rated capacity, they emit large amounts of heat, which could cause a fire.



- The product must only be installed and serviced by qualified service personnel. The product should be used as-is from the time of purchase; it should not be disassembled or modified. Disassembly or modification can cause a fire, electric shock, or damage to the product.
- Follow all warnings and instructions marked on the product.
- Products that require a power source should only be connected to the type of electrical power supply specified on the product label. If you are not sure of the type of power supply to your home, consult your dealer or local power company.
- For safety purposes some products are equipped with an earthed plug. If you do not have an earthed outlet, please have one installed. Do not bypass this safety feature by tampering with the plug.
- Regularly clean dust off of all equipment. Excessive amounts of dust can lead to fire or electric shock, and may impair the performance of the product.
- Unplug the product from the wall outlet and contact your dealer in the following cases:
  - a. When the power supply cord or plug is damaged or frayed.
  - b. If liquid has been spilled into the product.
  - c. If the product has been exposed to rain or water.
  - d. If the product does not operate according to the operating instructions. Adjust only the controls that are explained in the operating instructions. Improper adjustment of other controls may result in damage and may require service by a qualified technician to restore the product to normal operation.
  - e. If the product has been dropped or the cabinet has been damaged.
  - f. If product performance deteriorates.

### For the PBX



- Do not insert foreign objects of any kind into this product, as they may touch dangerous voltage points or short out parts that could result in a fire or electric shock.

### 1.1.1 For Your Safety

---

- Do not pull, bend, rest objects on, or chafe the power cord and plug. Damage to the power cord or plug can cause fire or electric shock.
- Do not attempt to repair the power cord or plug. If the power cord or plug is damaged or frayed, contact an authorised Panasonic Factory Service Centre for a replacement.



- When mounting the PBX on a 19-inch rack, only use the 19-inch rack mounting equipment (attachment bracket, screws) made for use with the PBX.
- If damage to the unit exposes any internal parts, disconnect the power supply cord immediately and return the unit to your dealer.
- Unplug this unit from the AC outlet if it emits smoke, an abnormal smell or makes unusual noise. These conditions can cause fire or electric shock. Confirm that smoke has stopped and contact an authorised Panasonic Factory Service Centre.
- This unit is equipped with an earthed plug. For safety reasons this plug must only be connected to an earthed outlet that has been installed according to applicable regulations.
- Plug the power cord firmly into an AC outlet. Otherwise, it can cause fire or electric shock.





## CAUTION

### For All Telephone Equipment



- The product should be kept free of dust, moisture, high temperature (more than 40 °C), and vibration, and should not be exposed to direct sunlight.
- Unplug the product from the wall outlet before cleaning. Wipe the product with a soft cloth. Do not clean with abrasive powders or with chemical agents such as benzine or thinner. Do not use liquid cleaners or aerosol cleaners.

### For the PBX



- When relocating the equipment, first disconnect the telecom connection before disconnecting the power connection. When the unit is installed in the new location, reconnect the power first, and then reconnect the telecom connection.
- The power supply cord is used as the main disconnect device. Ensure that the AC outlet is located near the equipment and is easily accessible.
- Slots and openings in the front, back and bottom of the cabinet are provided for ventilation; to protect it from overheating, these openings must not be blocked or covered. The openings should never be blocked by placing the product on a bed, sofa, rug, or other similar surface while in use. The product should never be placed near or over a radiator or other heat source. This product should not be placed in a sealed environment unless proper ventilation is provided.
- When this product is no longer in use, make sure to detach it from the rack or wall.
- To protect this unit from static electricity, do not touch any external connectors of the unit.

### **Notice**

#### **For All Telephone Equipment**

- Read and understand all instructions.
- When using a Panasonic proprietary telephone (PT), use only the correct Panasonic handset.

#### **For the PBX**

- Keep the unit away from heating appliances and devices that generate electrical noise such as fluorescent lamps, motors and televisions. These noise sources can interfere with the performance of the PBX.
- If you are having problems making calls to outside destinations, follow this procedure to test the outside lines:

1. Disconnect the PBX from all outside lines.
2. Connect known working single line telephones (SLTs) to those outside lines.
3. Make a call to an external destination using those SLTs.

If a call cannot be carried out correctly, there may be a problem with the outside line that the SLT is connected to. Contact your telephone company.

If all SLTs operate properly, there may be a problem with your PBX. Do not reconnect the PBX to the outside lines until it has been serviced by an authorised Panasonic Factory Service Centre.

### **Note**

#### **For All Telephone Equipment**

- Never attempt to insert wires, pins, etc. into the vents or holes of the product.

## 1.1.2 Important Safety Instructions

When using your telephone equipment, basic safety precautions should always be followed to reduce the risk of fire, electric shock and injury to persons, including the following:

- Do not use the product near water, for example, near a bathtub, wash bowl, kitchen sink, or laundry tub, in a wet basement, or near a swimming pool.
- Avoid using wired telephones during an electrical storm. There is a remote risk of electric shock from lightning.
- Do not use a telephone in the vicinity of a gas leak to report the leak.
- Rack Mount Instructions—The following or similar rack-mount instructions are included with the installation instructions:
  - a. Elevated Operating Ambient—If installed in a closed or multi-unit rack assembly, the operating ambient temperature of the rack environment may be greater than room ambient. Therefore, consideration should be given to installing the equipment in an environment compatible with the maximum ambient temperature (T<sub>ma</sub>) specified by the manufacturer.
  - b. Reliable Earthing—Reliable earthing of rack-mounted equipment should be maintained. Particular attention should be given to supply connections other than direct connections to the branch circuit (e.g., use of power strips).

**SAVE THESE INSTRUCTIONS**

### 1.1.3 Data Security

In order to use the PBX safely and correctly, the Security Requirements below must be observed. Failure to do so may result in:

- Loss, leakage, falsification or theft of user information.
- Illegal use of the PBX by a third party.
- Interference or suspension of service caused by a third party.

#### **What is User Information?**

User Information is defined as:

1. Information stored in the System Memory:  
System data, error data and activation key files.
2. Information sent from the PBX to a PC or a USB memory device:  
System data, sound files for MOH (Music on Hold) and OGM (Outgoing Messages), and activation key files.

#### **Requirements**

1. The System Memory contains software for all the processes of the PBX and all the customer data. Therefore, do not allow unauthorised access to prevent data leakage.
2. Always make backups of data stored in the System Memory and/or perform regular system data backups to a USB memory device or a NAS. For details, consult your dealer.
3. To prevent illegal access from the Internet, activate a Firewall.
4. To avoid unauthorised access and possible abuse of the PBX, we strongly recommend:
  - a. Keeping the password secret.
  - b. Selecting a complex, random password that cannot be easily guessed.
  - c. Changing your password regularly.
5. Perform the following when sending the PBX for repair or handing it over to a third party.
  - a. Make a backup of data stored in the System Memory.
6. When user information is sent from the PBX to a PC or a USB memory device, the confidentiality of that information becomes the responsibility of the customer. Before disposing of the PC or the USB memory device, ensure that data cannot be retrieved from it by formatting the hard disk and/or rendering it physically unusable.

## 1.1.4 Before Operating the Telephones

### ◆◆ What Kind of Telephone Can Be Used?

You can use the following types of telephone with this PBX:

- Panasonic IP Proprietary Telephone (IP-PT)  
(e.g., KX-NT300 series, KX-NT500 series)
- Panasonic Digital Proprietary Telephone (DPT)  
(e.g., KX-T7600 series, KX-DT300 series, KX-DT500 series)
- Panasonic Analogue Proprietary Telephone (APT)  
(e.g., KX-T7700 series)
- Panasonic Portable Station (PS)  
(e.g., KX-TCA364, KX-WT115)
- SIP-CS compatible Portable Station (S-PS)  
(e.g., KX-UDT series)
- SIP phone  
(e.g., KX-UT series SIP phones, Third party SIP phones)
- Single Line Telephone (SLT)  
(e.g., rotary pulse telephone)

Which features are available depend on the type of telephone being used. If you are using a Panasonic telephone with a special feature button such as  or a display or both, you can follow the operations using the buttons or displayed messages for easy programming. If you use a large display telephone (e.g., KX-NT346 or KX-T7636), you can follow the displayed messages to use the features. If your telephone does not have feature buttons and/or a display, you may operate the PBX by entering a feature number instead. Follow the operation for your type of telephone.

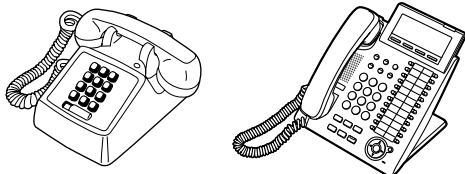

- If you use a Panasonic proprietary telephone which does not have feature buttons, you may change one of the unused flexible buttons to a feature button. Refer to "3.1.3 Customising the Buttons".

### Registration for your Portable Station (PS)/SIP Phone/SIP-CS compatible Portable Station (S-PS)

Your PS, SIP phone, or S-PS must be registered with the PBX and assigned an extension number before initial use, through system programming. To confirm the extension number of your PS, refer to "Your extension information" in "3.1.2 Settings on the Programming Mode". For SIP phone and S-PS users, follow the instructions for your phone.

### ◆◆ Feature Numbers

To use certain features, you need to enter specified feature numbers (and an additional parameter, if required). There are two types of feature numbers as follows:

- Flexible feature number
- Fixed feature number

Fixed feature numbers cannot be changed. However, you can change the flexible numbers to other numbers for easier use. In this manual, the default numbers (factory installed) are used for operations.

## 1.1.4 Before Operating the Telephones

---

A flexible number is shown as  (half-shaded key). Use the new programmed number if you have changed the feature number. Write the new number in "5.3.1 Feature Number Table" (Appendix).

### **Notice**

The default value of a flexible feature number may vary depending on country/area.



**If you use a single line telephone which does not have the "\*" or "#" keys;** it is not possible to access features that have "\*" or "#" in their feature numbers.

### ◆◆ **Tone**

You will hear various tones, during or after an operation, for confirmation. Refer to "5.4.1 What is This Tone?" (Appendix).

### ◆◆ **Display**

In this manual, "the display ..." refers to the display of a Panasonic telephone. If your telephone is not a Panasonic display telephone, the message will not be displayed. If you use a Panasonic display telephone, the display helps you confirm the settings. Some telephones also give you easy access to features. Messages are displayed according to the feature used. By pressing the corresponding button on the side or at the bottom of the display, or by pressing the Navigator Key, you can access various features. Furthermore, depending on the display telephone used, you can operate features or make calls using the displayed message. Refer to "1.14 Using a Telephone with a Display".

### **Notice**

In this manual, the display messages are described in English.

### **Your Extension Number**

If you use a Panasonic display proprietary telephone, you can check your own extension number on the display. Press the TRANSFER button or Soft (S1) button while on-hook.

### **ECO mode**

If you use a KX-NT543, KX-NT546, or KX-NT560 IP-PT in ECO mode, the "ECO" icon is shown on the display during programming mode (refer to "3.1.3 Customising the Buttons"). For more information, consult your dealer.

### ◆◆ **Using a Navigator Key/Jog Dial/Volume Key**

The Navigator Key can be used for the display contrast and the volume control or you can search for desired items on the display. Press the Navigator Key/Volume Key or rotate the Jog Dial in the desired direction. The contrast or the volume level and the items will change as follows:

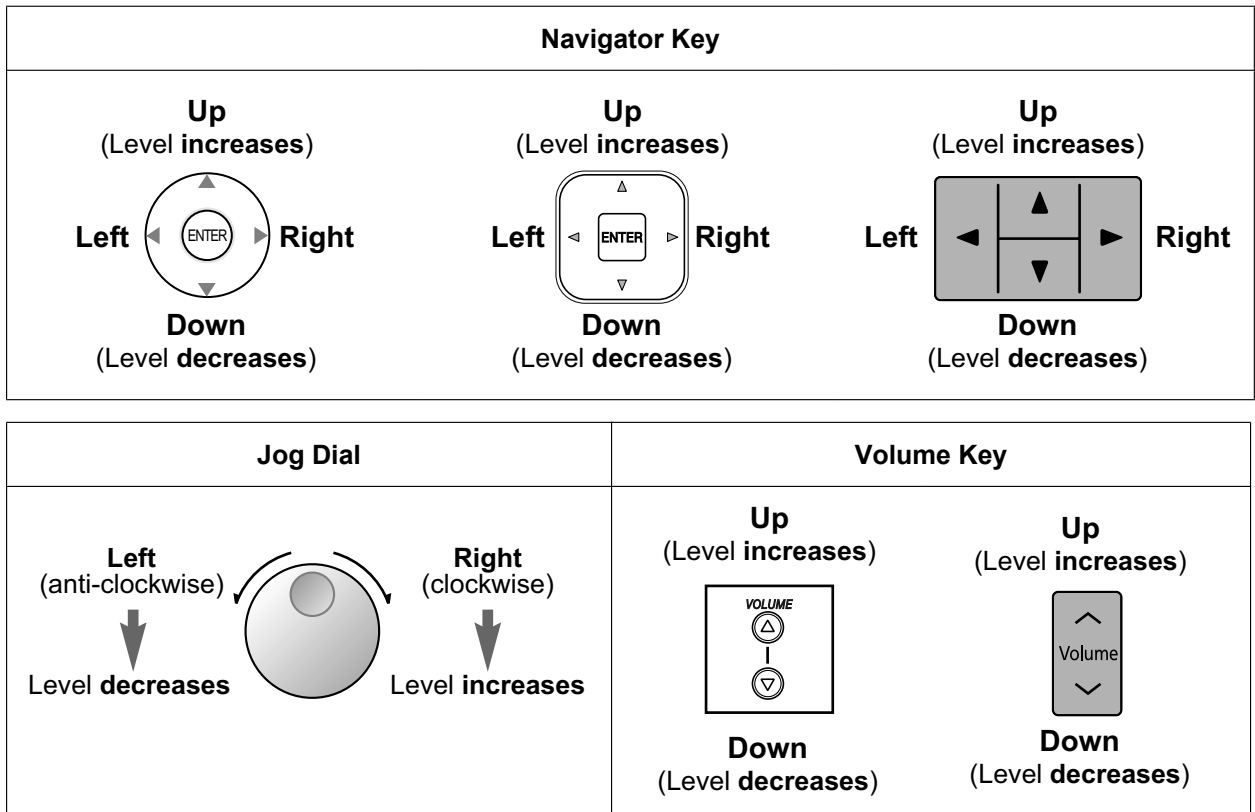

### ◆◆ Examples



The displays and the illustrations shown as examples are from a telephone connected to the KX-NS300.

### ◆◆ Restrictions





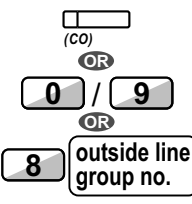

Some features may be restricted at your extension depending on system programming and the type of telephone being used.

### ◆◆ Icon Descriptions

The following icons show you the feature availability, notes and action to use the features.

	<p>This feature cannot be used with a single line telephone.</p>		<p>Seize an outside line (One of the following).</p> <ul style="list-style-type: none"> <li>Press the CO button.</li> <li>Dial automatic line access number 0/9.</li> <li>Dial outside line group access number and outside line group number.</li> </ul>
	<p>See "Programming" for Related Programming if necessary.</p>		

### 1.1.4 Before Operating the Telephones

	Off-hook (One of the following). <ul style="list-style-type: none"> <li>Lift the handset.</li> <li>Press the SP-PHONE button.</li> <li>Press the MONITOR button. (To start talking, lift the handset.)</li> <li>Press TALK button.</li> </ul>		Press the Call button on the Doorphone.
	On-hook (One of the following). <ul style="list-style-type: none"> <li>Hang up.</li> <li>Press the SP-PHONE button.</li> <li>Press the MONITOR button.</li> <li>Press CANCEL button.</li> </ul>		Press the hookswitch lightly.
	Press the corresponding feature button on the proprietary telephone, KX-UT series SIP phone, or S-PS.		Talk or make an announcement.
<b>desired no.</b>	Enter the required number. <Example> <b>account code</b> Enter the account code.		You will hear a busy, confirmation, dial, ring or ringback tone. B. Tone: Busy Tone C. Tone: Confirmation Tone D. Tone: Dial Tone R. Tone: Ring Tone R. B. Tone: Ringback Tone
<b>extension no.</b>	Dial an extension number.	<b>outside phone no.</b>	Dial outside phone number.
<b>phone no.</b>	Dial the telephone number.	<b>dial key</b>	Press any dial key (0–9, *, #).
<b>HOLD</b>	Press the HOLD button on your SIP phone.	<b>REDIAL</b>	Press the REDIAL button on your SIP phone.

### ◆◆ When You Use a Panasonic Proprietary Telephone or KX-UT Series SIP Phone

Panasonic proprietary telephones and KX-UT series SIP phones have useful feature buttons that simplify some operations. For details, refer to the "Location of Controls" or equivalent section in the documentation for your phone.

#### Customised Buttons

If the term is in parentheses like (Account) in this manual, it means a flexible button has been made into an "Account" button. For more information, refer to "3.1.3 Customising the Buttons" when using a PT or PS, or "Customising the Flexible Buttons" when using Web Maintenance Console.

#### Note

##### For KX-UT series SIP phone users:

- KX-UT113/KX-UT123: Customised buttons are not available.
- Other than KX-UT113/KX-UT123: The following buttons can be customised:



- Single-CO (S-CO)
- DN
- One-touch Dialling
- Log-in/Log-out
- DSS
- Headset
- Wrap-up
- Call Park
- Call Park (Automatic Park Zone)

**For S-PS users:**

- The following buttons can be customised:
  - Single-CO (S-CO)
  - DN
  - One-touch Dialling
  - Log-in/Log-out
  - DSS
  - Wrap-up
  - Call Park
  - Call Park (Automatic Park Zone)

Button	Feature
Loop-CO (L-CO)	Used to access an idle outside line for making outside calls. Incoming outside calls from any outside line arrive at this button.
Group-CO (G-CO)	Used to access an idle outside line in a specified outside line group for making outside calls. Incoming calls from outside lines in the assigned outside line group arrive at this button.
Single-CO (S-CO)	Used to access a specified outside line for making or receiving outside calls.
Direct Station Selection (DSS)	Used to access an extension with one touch. It is also possible to be changed to the other feature button. For KX-UT series SIP phones (except KX-UT113/KX-UT123) and S-PSs, unlike a One-Touch button, this type of button cannot be used to dial feature numbers.
One-touch Dialling	Used to access a desired party or system feature with one touch.
Incoming Call Distribution Group (ICD Group)	Used to access a specified incoming call distribution group for making or receiving calls.
Message	Used to leave a message waiting indication or call back the party who left the message waiting indication.
Message for Another Extension	Used to have a Message button for another extension.
Call Forwarding (FWD)/Do Not Disturb (DND)—Both calls	Used to forward all calls to a specified destination or refuse.
FWD/DND—Outside calls	Used to forward outside calls to a specified destination or refuse.
FWD/DND—Intercom calls	Used to forward intercom calls to a specified destination or refuse.
Group FWD—Both calls	Used to forward all the calls to your group to a specified destination.
Group FWD—Outside calls	Used to forward the outside calls to your group to a specified destination.
Group FWD—Intercom calls	Used to forward the intercom calls to your group to a specified destination.
Account	Used to enter an account code.

### 1.1.4 Before Operating the Telephones

Button	Feature
Conference	Used to establish a multiple party conversation.
Terminate	Used to disconnect the current call and make another call without hanging up.
External Feature Access (EFA)	Used to access special features offered by a host PBX or a telephone company.
Call Charge Reference	Used to check the total call charge for your own extension.
Call Park	Used to park or retrieve a call in a preset parking zone.
Call Park (Automatic Park Zone)	Used to park a call in an idle parking zone automatically. For KX-UT series SIP phones (except KX-UT113/KX-UT123) and S-PSs, pressing this button selects an idle parking zone from among the Call Park (preset parking zone) buttons configured on the phone. Set both the Call Park (Automatic Park Zone) button and the Call Park (Preset Parking Zone) button.
Call Log	Used to show the incoming call information.
Call Log for ICD Group	Used to have a Call Log button for incoming call distribution group.
Log-in/Log-out	Used to switch between the log-in and log-out mode.
Log-in/Log-out of a specified group	Used to have a Log-in/Log-out button for another incoming call distribution group.
Log-in/Log-out for all groups	Used to have a Log-in/Log-out button for all groups.
Hurry-up	Used to transfer the longest waiting call in the queue of an incoming call distribution group to the overflow destination.
Wrap-up	Used to switch the wrap-up status, Ready and Not Ready mode.
System Alarm	Used to confirm a PBX error.
Time Service (Day/Night/Lunch/Break)	Used to switch the time service mode.
Answer	Used to answer an incoming call.
Release	Used to disconnect the line during or after a conversation or to complete a Call Transfer.
Toll Restriction/Call Barring	Used to change the toll restriction/call barring level of other extension users temporarily.
ISDN Service	Used to access an ISDN service.
Calling Line Identification Restriction (CLIR)	Used to switch between the CLIP and CLIR services.
Connected Line Identification Restriction (COLR)	Used to switch between the COLP and COLR services.
ISDN-Hold	Used to transfer a call using telephone company.
Headset	Used to talk using the headset.
Time Service Switching Mode (Automatic/Manual)	Used to switch the time service mode, Automatic or Manual.

Button	Feature
Two-way Record	Used to record a conversation into your own mailbox.
Two-way Transfer	Used to record a conversation into the mailbox of a specific extension.
One-touch Two-way Transfer	Used to record a conversation into the mailbox of a specific extension with one touch.
Live Call Screening (LCS)	Used to monitor your own voice mailbox while an incoming caller is leaving a message and, if desired, intercept the call.
Voice Mail Transfer	Used to transfer a call to the mailbox of a specified extension. Also used to access the Unified Messaging system or the voice mail features of a VPS with one touch.
Network Direct Station Selection (NDSS)	Used to access an extension connected to other PBXs in the network with one touch.
CTI	Used to access CTI features.
Check-in	Used to switch the room status of extensions from Check-out to Check-in.
Check-out	Used to switch the room status of extensions from Check-in to Check-out.
Cleaned-up	Used to switch the room status of extensions between Ready and Not Ready.
Primary Directory Number (PDN)	Used to make and receive both outside and intercom calls.
Secondary Directory Number (SDN)	Used to show the current status of another extension, call the extension, and pick up or transfer calls to it.
Directory Number (DN) (KX-UT series SIP phones [except KX-UT113/ KX-UT123]/S-PS only)	Used to make intercom or outside calls.

## ◆◆ How to Follow the Steps

An example of system operation is shown below.

### ◆◆ Calling Another Extension

**To call an extension (Intercom Call)**

**PT/SLT/PS/SIP Extn./S-PS**



Off-hook.

extension no.

OR

(DSS)



Talk.

Dial **extension number** or press **DSS**.

**Feature title**

**Telephone types**  
The abbreviations of telephone types are explained in "Telephone types in procedures" below.

**Operation steps**  
The description of the icons are explained on "Icon Descriptions".

**Conditions**

**Hints**

- The DSS button light shows the current status as follows:  
**Off:** The extension is idle.  
**Red on:** Your or another extension is using the line.
- To call using a directory, refer to "1.14.2 Using the Directories".
- **For quick operation**  
If you are an operator or dial some extensions frequently, DSS buttons are useful.
- **Hands-free Operation**  
You can make an intercom call and have a conversation in hands-free mode using the SP-PHONE button.

**Customising Your Phone**

- 3.1.2 Settings on the Programming Mode—**Preferred Line Assignment—Outgoing**  
Select the seized line when going off-hook.
- 3.1.3 Customising the Buttons  
Create or edit a Direct Station Selection (DSS) button.

**Programming References:** The related or required programming is noted.

### Telephone types in procedures

The following abbreviations are displayed at the top left of each procedure and indicate which types of telephones support the operation. However, in some cases a specific model number is given instead (e.g., KX-UT136, KX-UT series).

Abbreviation	Telephone Type
PT	Proprietary Telephone (e.g., KX-NT300 series, KX-NT500 series, KX-NT265, KX-T7700 series)
	DPT Digital Proprietary Telephone (e.g., KX-T7600 series, KX-DT300 series, KX-DT500 series)
	Display PT Proprietary Telephone with a Display (e.g. KX-NT346, KX-NT546, KX-DT346, KX-DT546, KX-T7636)
PS	Portable Station (e.g., KX-TCA364, KX-WT115)
SIP Extn.	SIP phone (e.g., KX-UT series SIP phones, Third party SIP phones)

<b>Abbreviation</b>	<b>Telephone Type</b>
S-PS	SIP-CS compatible Portable Station (e.g., KX-UDT series)
SLT	Single Line Telephone (e.g., KX-T7710)

## ◆◆ Connection Example

This diagram shows you a connection example.

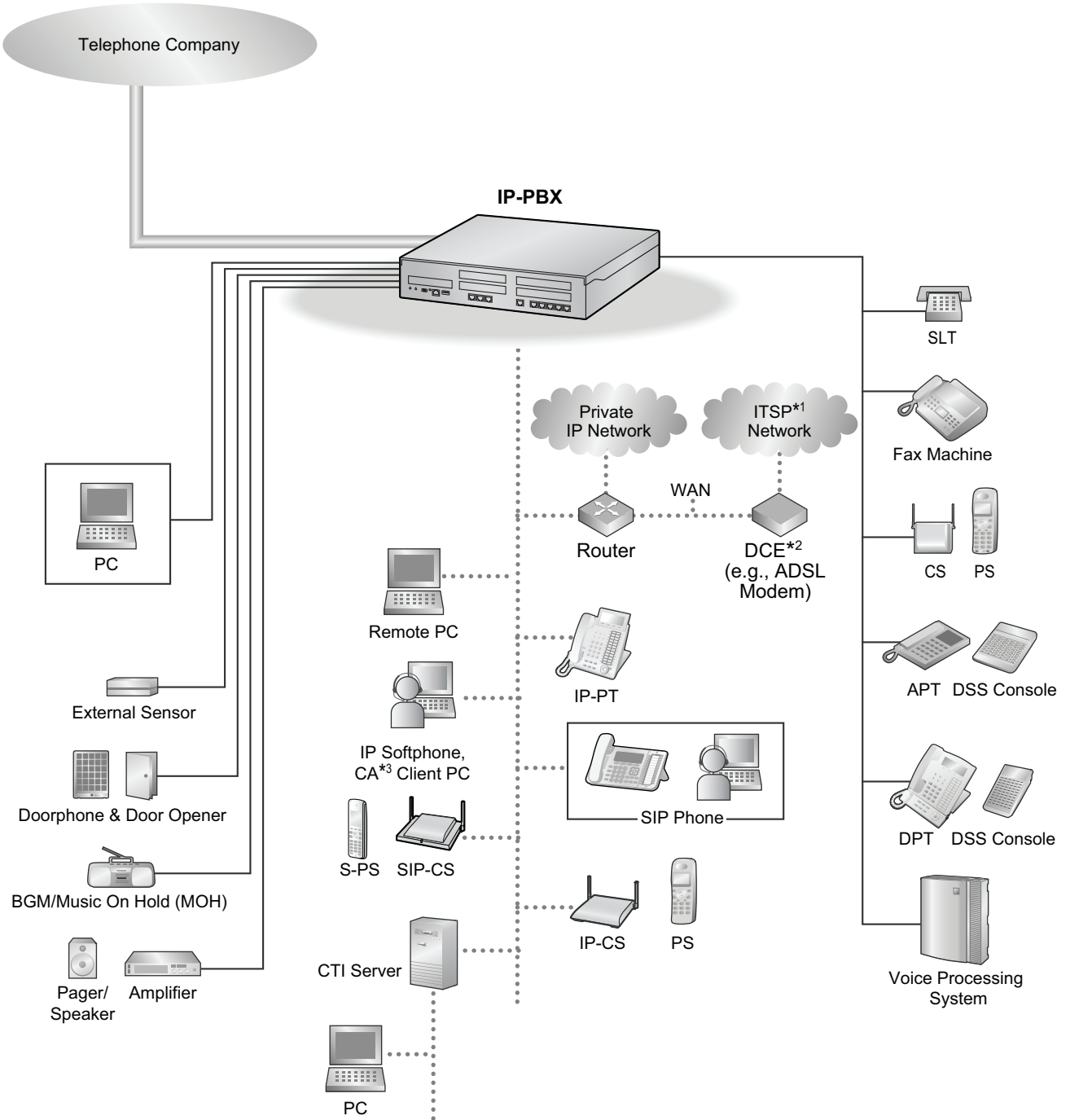

\*1 ITSP: Internet Telephony Service Provider

\*2 DCE: Data Circuit Terminating Equipment

\*3 CA: Communication Assistant

## 1.2 Making Calls

### 1.2.1 Basic Calling

- ◆◆ Calling Another Extension
- ◆◆ Calling an Outside Party
- ◆◆ Making a Call to a Private Network (TIE Line Access)
- ◆◆ Using an Account Code (Account Code Entry)

#### ◆◆ Calling Another Extension

To call an extension (Intercom Call)

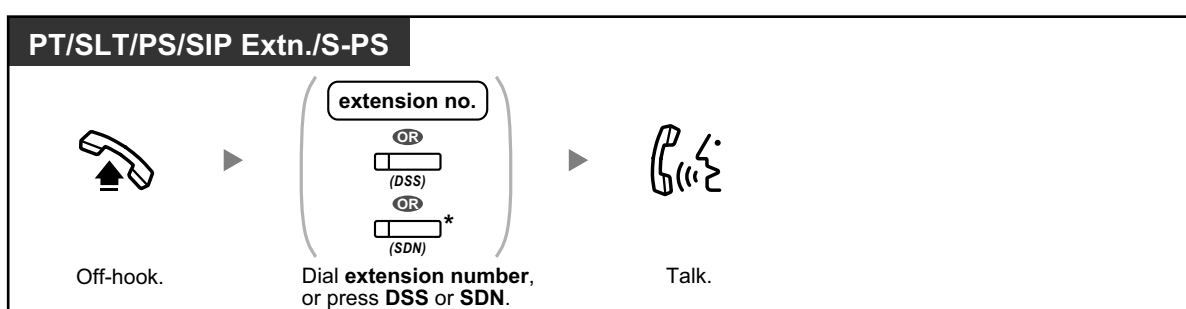

- The DSS button light shows the current status as follows:  
**Off:** The extension is idle.  
**Red on:** Your or another extension is using the line.
- \* You have to press the SDN button once or twice depending on the mode of the SDN button. For details, refer to "1.5.1 Primary Directory Number (PDN)/Secondary Directory Number (SDN) Extension".



- To call using a directory, refer to "1.14.2 Using the Directories".
- **For quick operation**  
If you are an operator or dial some extensions frequently, DSS buttons are useful.
- **Hands-free Operation**  
You can make an intercom call and have a conversation in hands-free mode using the SP-PHONE button.



#### Customising Your Phone

- 3.1.2 Settings on the Programming Mode—**Preferred Line Assignment—Outgoing** Select the seized line when going off-hook.
- 3.1.3 Customising the Buttons  
Create or edit a Direct Station Selection (DSS) button.

### To call an operator (Operator Call)

You can call an extension or a group assigned as the operator.



- The operator call number (default) varies depending on country/area.

### ◆◆ Calling an Outside Party

You have to seize an outside line before dialing an outside phone number because external calls are made via your PBX.

Select one of the following methods:

#### To select an idle outside line automatically (Automatic Line Access)

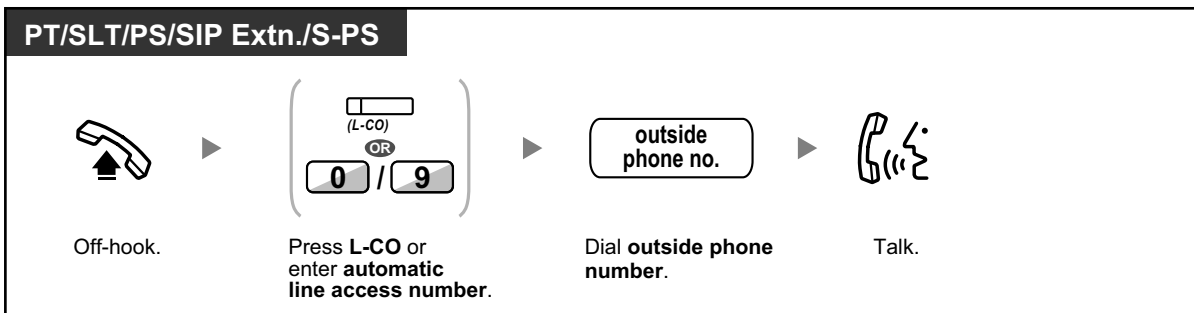

- The automatic line access number (default) varies depending on country/area.

#### To select an idle outside line in the specified outside line group automatically (Outside Line Group Access)

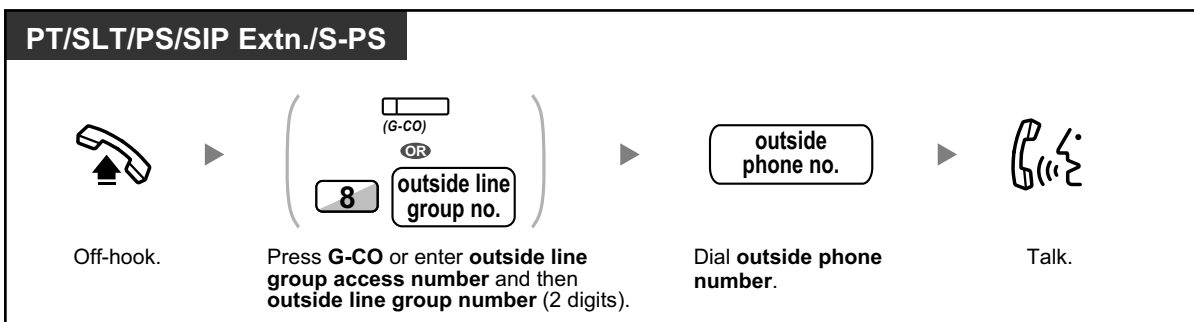



### To select the specified outside line



- Each of the S-CO button or G-CO button light shows the current status as follows:  
**Off:** The line is idle.  
**Red on:** The line is in use.
- You may be restricted from making a call to the specified outside party. To make a call, refer to "1.2.7 Calling without Restrictions".



- **To confirm number before dialling**, you can enter a phone number and confirm it on the display and then go off-hook. (Predialling)
- **Call Charge Reference**  
 You can confirm your total call charges by pressing the Call Charge Reference button.
- **To make a call to another party without going on-hook**, press the FLASH/RECALL button. It will re-access the outside line and provide external dial tone. Pressing the Terminate button will provide intercom dial tone. You can dial the new phone number without going on/off-hook.
- **Hands-free Operation**  
 You can make an outside call and have a conversation in hands-free mode using the SP-PHONE button.



### Customising Your Phone

- 3.1.2 Settings on the Programming Mode—**Preferred Line Assignment—Outgoing** Select the seized line when going off-hook.
- 3.1.3 Customising the Buttons  
 Create or edit a Loop-CO (L-CO) button, a Group-CO (G-CO) button, a Single-CO (S-CO) button, a Terminate button or a Call Charge Reference button.

## ◆◆ Making a Call to a Private Network (TIE Line Access)

You can access extensions connected to other PBXs in a private network.

### To call

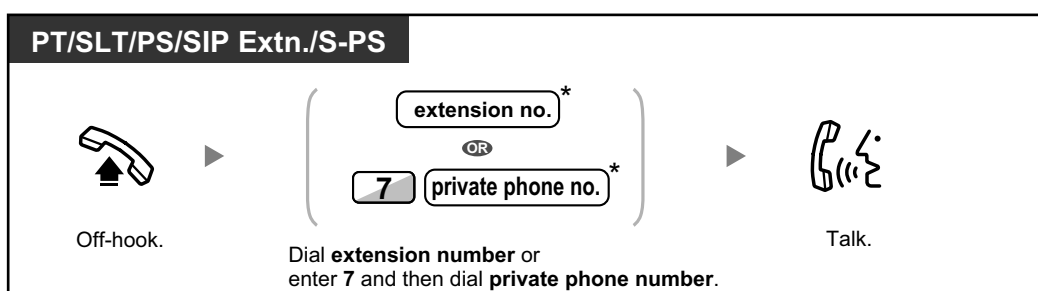

## 1.2.1 Basic Calling



- \* Which type of telephone number must be entered depends on the settings of your PBX.

### To call with one touch



- To start monitoring another PBX extension after customising an NDSS button, go off-hook, press the NDSS button, and go on-hook.**  
The NDSS button light will show the current status as follows:  
**Off:** The extension is idle.  
**Red on:** The extension is busy.



### Customising Your Phone

- 3.1.3 Customising the Buttons  
Create or edit a Network Direct Station Selection (NDSS) button.

## ◆◆ Using an Account Code (Account Code Entry)

You may give a specified account code to extension users and check their telephone usage. You can specify an account code for each client and check the call duration.

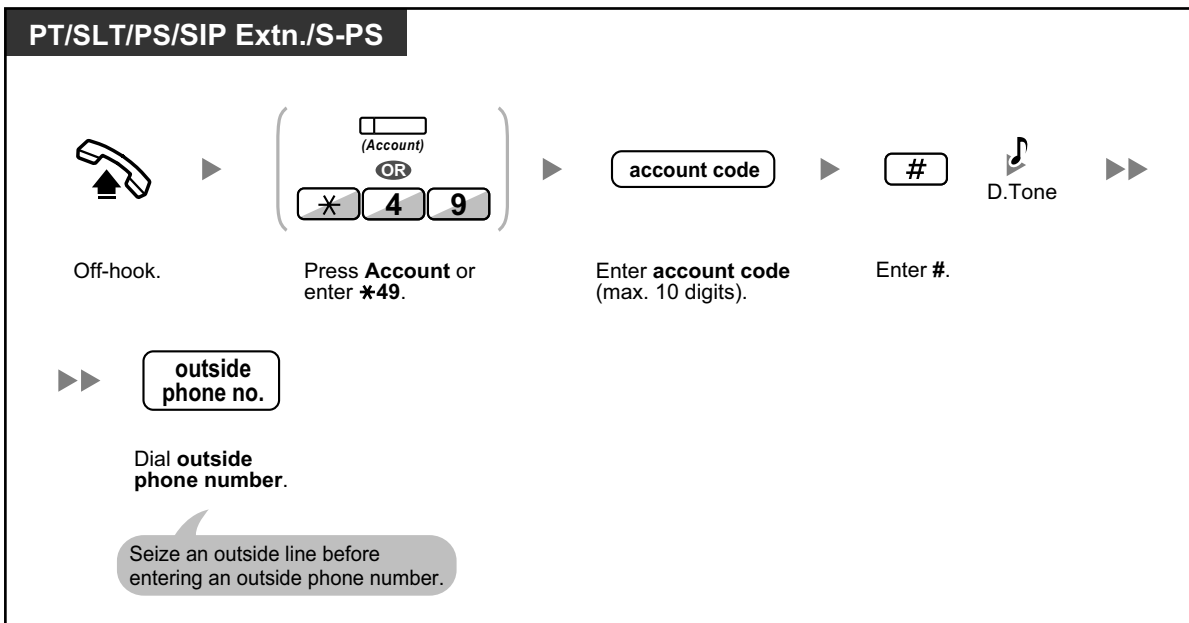



- **A Panasonic proprietary telephone extension user** can enter an account code during a conversation and when hearing reorder tone after the other party hangs up.
- Account codes may use the digits "0" through "9".
- Depending on the settings of your PBX, you may be required to enter an account code to make an outside call.
- **If you enter the wrong code**, press the "\*" key and re-enter the account code.



- **For your convenience**, you can store the code with the phone number in the memory (e.g., Speed Dialling).



### Customising Your Phone

- 3.1.3 Customising the Buttons  
Create or edit an Account button.

## 1.2.2 Easy Dialling

This is convenient for frequently dialled phone numbers.

- ◆◆ With a One-touch Button (One-touch Dialling)
- ◆◆ Using Numbers Stored at Your Extension (Personal Speed Dialling)
- ◆◆ Using Numbers Stored in the PBX (System Speed Dialling)
- ◆◆ To a Preset Number by Going Off-hook (Hot Line)
- ◆◆ Using a Preprogrammed Number (Quick Dialling)

### ◆◆ With a One-touch Button (One-touch Dialling)

You can store a phone number into the flexible button for one-touch operation.



#### Customising Your Phone

- 3.1.3 Customising the Buttons  
Create or edit a One-touch Dialling button, store the desired phone number or feature number.

### ◆◆ Using Numbers Stored at Your Extension (Personal Speed Dialling)

You can store up to 100 numbers at your extension for your personal use. This feature is also known as Station Speed Dialling.

#### To store a phone number

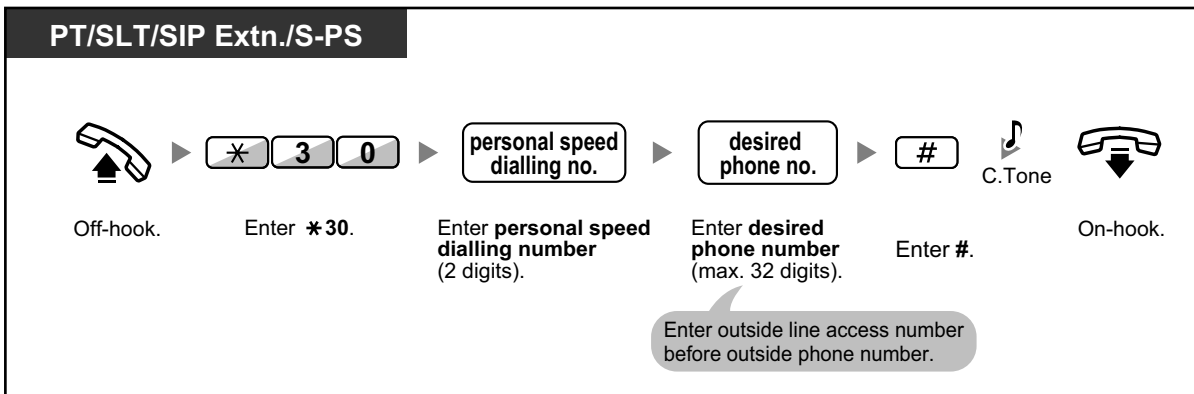

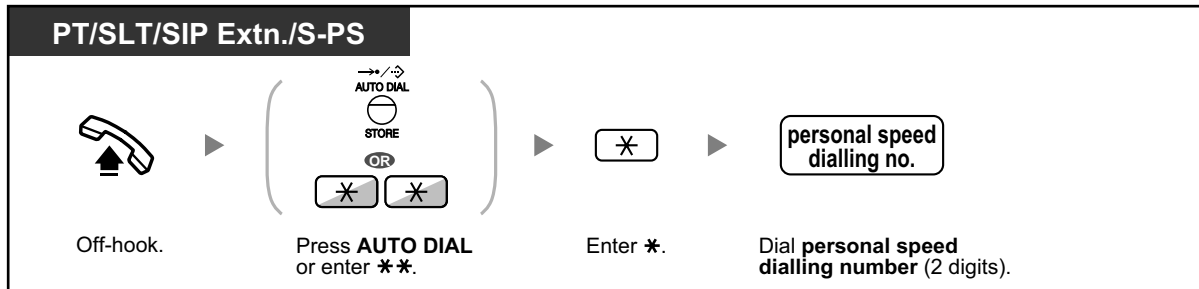
**To dial**

- To call using a directory, refer to "1.14.2 Using the Directories".
- For SIP phone and S-PS users: Telephones display only personal speed dialling numbers.

### ◆◆ Using Numbers Stored in the PBX (System Speed Dialling)

You can make calls using speed dialling numbers stored in the PBX.

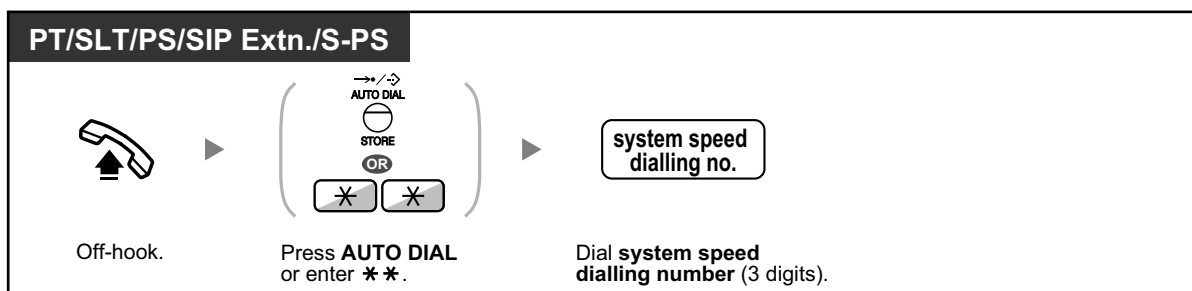

- To call using a directory, refer to "1.14.2 Using the Directories".
- For SIP phone and S-PS users: Telephones display only system speed dialling numbers.

### ◆◆ To a Preset Number by Going Off-hook (Hot Line)

You can make an outside call simply by going off-hook if you have preprogrammed your phone. This feature is also known as Pickup Dialling.

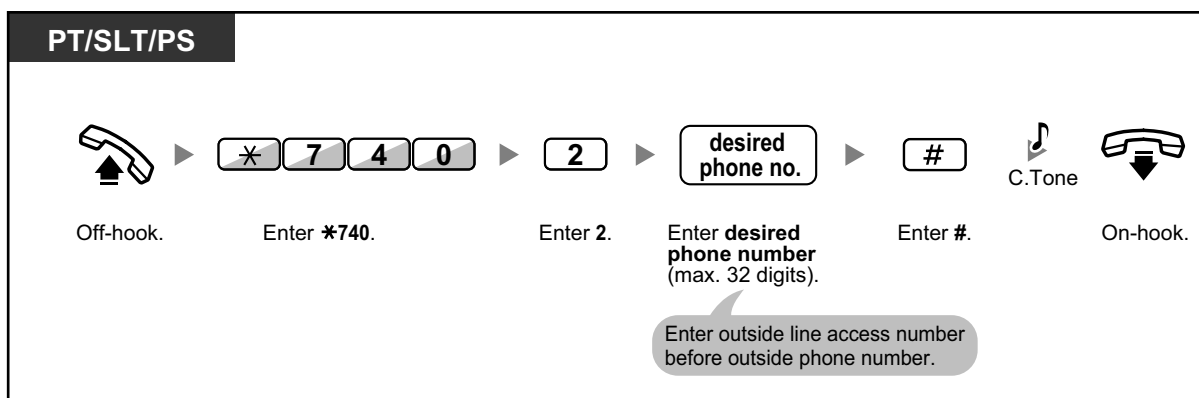
**To store a phone number**

**To set/cancel**

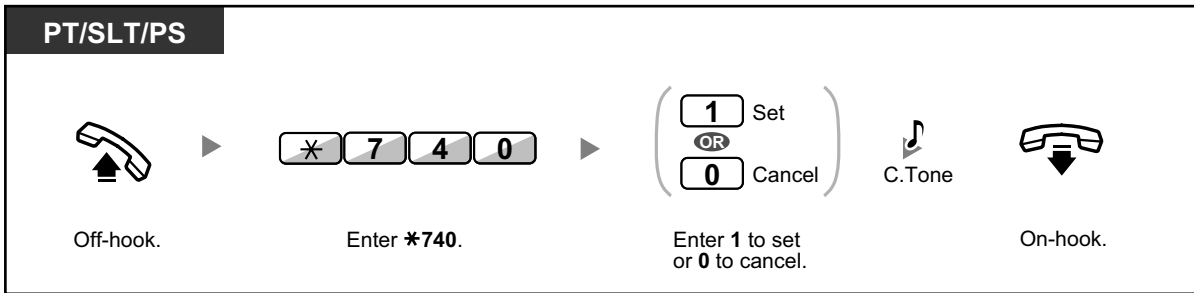

**To dial**



- **To call another party**, dial the desired party’s phone number before the preprogrammed number is dialled.
- You should assign the intercom line as the seized line when going off-hook. (Preferred Line Assignment—Outgoing)
- It is possible to increase the delay before Hot Line is activated through system programming. This can be useful if you require more time after going off-hook to dial another telephone number or extension number.



**Customising Your Phone**

- 3.1.2 Settings on the Programming Mode—**Preferred Line Assignment—Outgoing**  
Select the seized line when going off-hook.

**Using a Preprogrammed Number (Quick Dialling)**

You can make a call simply by pressing the preprogrammed number for quick dialling.

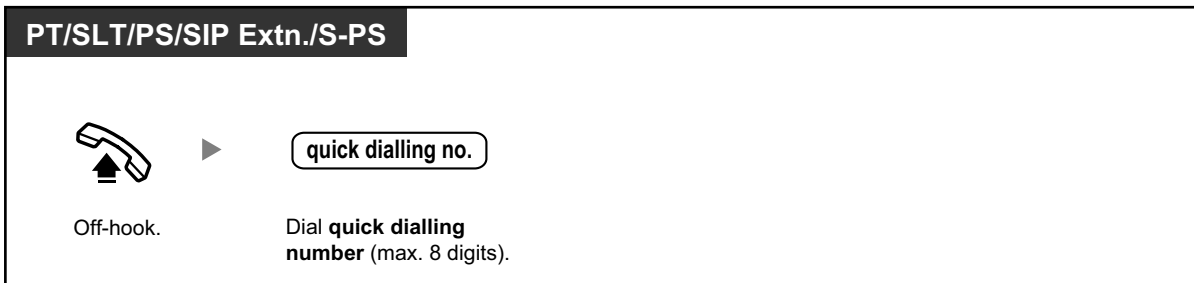

- This is a useful feature for hotels. For example, to dial Room Service, dial the digit "3", not the full extension number.

## 1.2.3 Redial

This is convenient when calling the same outside party again.

- ◆◆ Redialling the Last Number You Dialed (Last Number Redial)

### ◆◆ Redialling the Last Number You Dialed (Last Number Redial)

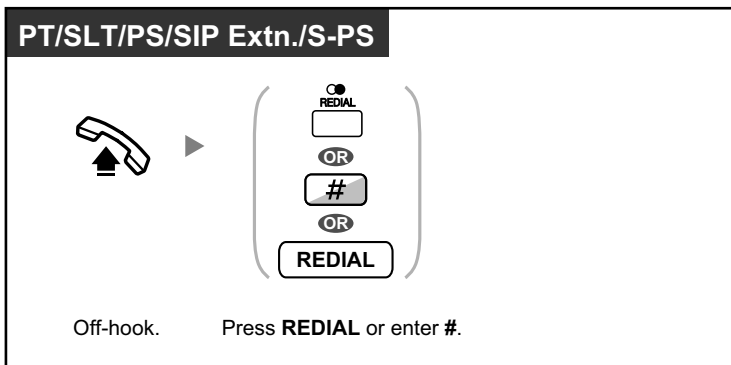

- Up to 32 digits can be stored and redialled.
- After pressing REDIAL, if you hear a busy tone again, press REDIAL to retry.
- If you want to log outgoing intercom calls to the outgoing call log, consult your System Installer.
- If you have seized a trunk, pressing the REDIAL button will be ignored if the last number you dialed was an extension.



- **Automatic Redial**  
**To redial automatically**, press the SP-PHONE button and then the REDIAL button, or press the REDIAL button directly. It will keep trying the busy number until the called party answers or until a specified timeout.  
 You can perform other tasks during dialling. To cancel, press the FLASH/RECALL button.  
 Some outside lines may not support this feature.  
 This feature is not available for the KX-T7665 or PS.

## 1.2.4 When the Dialed Line is Busy or There is No Answer

- ◆◆ Reserving a Busy Line (Automatic Callback Busy)
- ◆◆ Setting Callback on an ISDN Line (Completion of Calls to Busy Subscriber [CCBS])
- ◆◆ Sending a Call Waiting Notification (Call Waiting)
- ◆◆ Leaving a Message Waiting Indication/Calling Back the Caller Who Left an Indication (Message Waiting)
- ◆◆ Joining an Existing Call (Executive Busy Override)
- ◆◆ Monitoring Another Extension (Call Monitor)
- ◆◆ To an Extension Refusing the Call (DND Override)

### ◆◆ Reserving a Busy Line (Automatic Callback Busy)

You can set the telephone to receive callback ringing:

- when a dialed extension becomes idle.
- when your desired outside line that is in use by another extension becomes idle.

You cannot set Automatic Callback Busy for a busy party outside of the PBX.



When you answer the callback ringing:

- For an outside call: The line is seized.
- For an intercom call: The called extension starts ringing automatically.

#### To set (for both extension and outside line)

**PT/SLT/PS**



*While hearing a busy tone*

		
Enter 6.	C.Tone	On-hook.

#### To answer the callback ringing from an idle extension

**PT/SLT/PS**

*While hearing a callback ringing*

		
Off-hook.	R.B.Tone	Talk.



**To answer the callback ringing from an idle outside line**

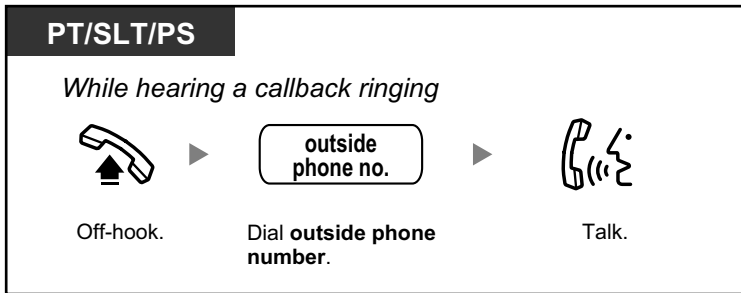

- If you do not answer the callback ringing within 10 seconds, this feature will be cancelled.

**To cancel callback ringing (Automatic Callback Busy Cancel)**

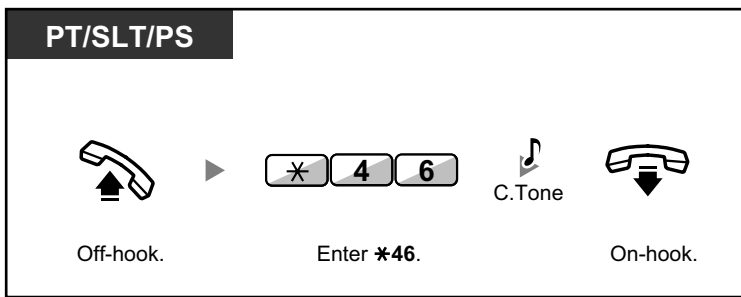

**◆◆ Setting Callback on an ISDN Line (Completion of Calls to Busy Subscriber [CCBS])**

You can set the telephone to receive callback ringing when a busy called party on an ISDN line becomes free. When you answer the callback ringing, the called party's telephone number is automatically dialed.

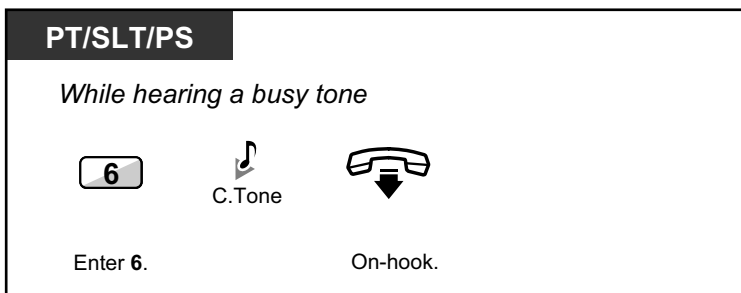

### To answer while hearing a callback ringing

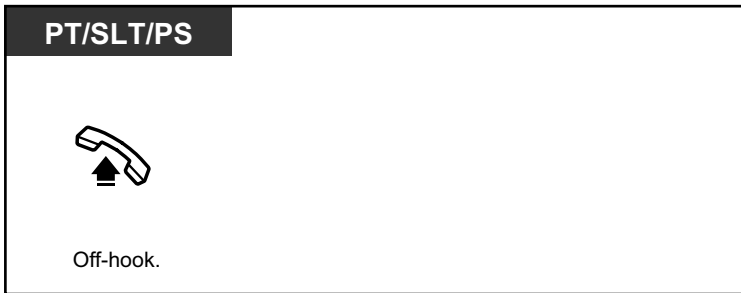

### To cancel (CCBS Cancel)

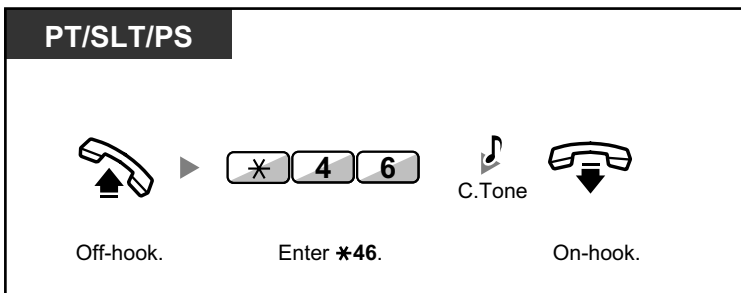

- If you do not answer within a specified time period, this feature will be cancelled.
- Availability of this feature depends on the ISDN service of your telephone company.

## ◆◆ Sending a Call Waiting Notification (Call Waiting)

You can inform the called party that your call is waiting.  
This feature is also known as Busy Station Signalling (BSS).

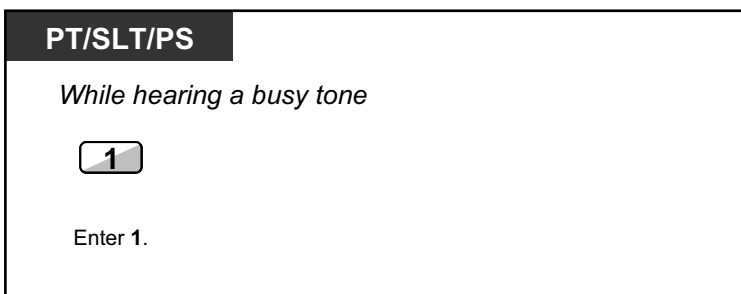

- **Depending on the type of the other party's telephone**, you may be able to talk to the other party using the speaker and the microphone (Off-hook Call Announcement [OHCA]), or you can send a call announcement through the handset (Whisper OHCA), if they are having another conversation using the handset.  
Refer to "1.9.3 Receiving Call Waiting (Call Waiting/Off-hook Call Announcement [OHCA]/Whisper OHCA)".
- Depending on system programming and the called extension's setting, a call waiting tone may be sent automatically without performing the operation above.

## ◆◆ Leaving a Message Waiting Indication/Calling Back the Caller Who Left an Indication (Message Waiting)

### ◆ For an extension leaving a message waiting indication

When the called extension is busy or does not answer your call, you can leave a notification so that the called party may call you back.

### ◆ For an extension receiving a message waiting indication

As a message receiver, the Message button light or Message/Ringer Lamp lets you know that a call has been received. If you receive notification, you can call the caller back by a simple operation.

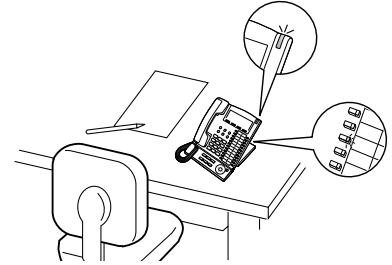

### ◆ For an extension leaving a message waiting indication

To leave a message waiting indication

**PT/SLT/PS**

*When the called extension is busy or does not answer*

Press **MESSAGE**  
or enter **4**.

C.Tone

On-hook.

To leave/cancel a message waiting indication

**PT/SLT/PS/SIP Extn./S-PS/KX-UT series**

Off-hook.

Enter **\*70**.

1

Leave

OR

0

Cancel

Enter **1** to leave  
or **0** to cancel.

desired  
extension no.

Enter **desired  
extension number**.

C.Tone

On-hook.

1.2.4 When the Dialed Line is Busy or There is No Answer

◆ For an extension receiving a message waiting indication

To check the left message and call back

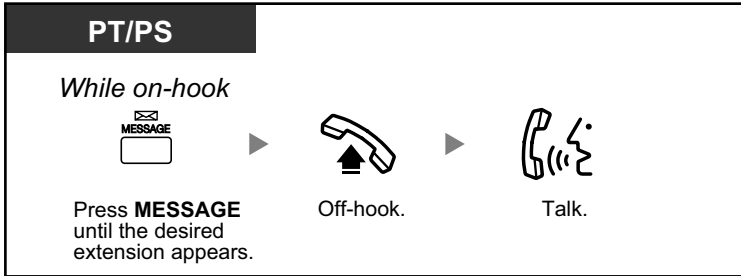

To call back

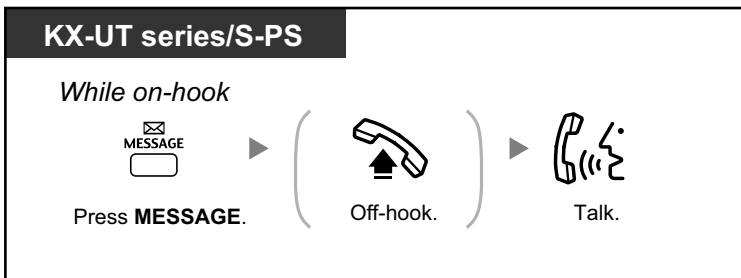
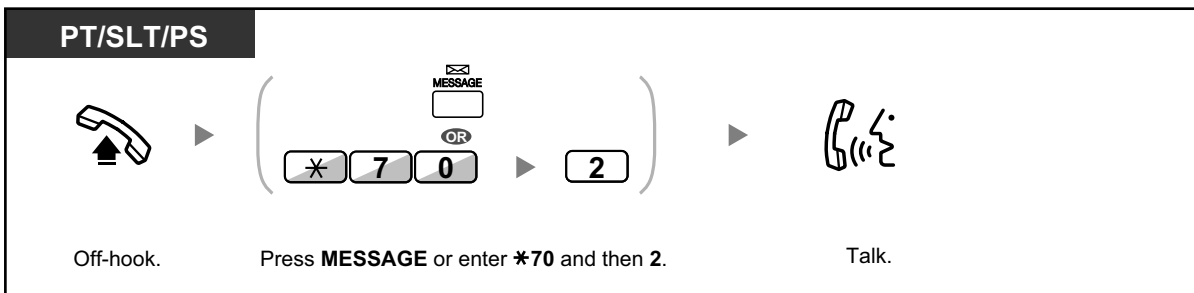

- Performing this operation after receiving multiple waiting indications will call back the extension that left the most recent message waiting indication.

To clear message waiting indications left on your extension

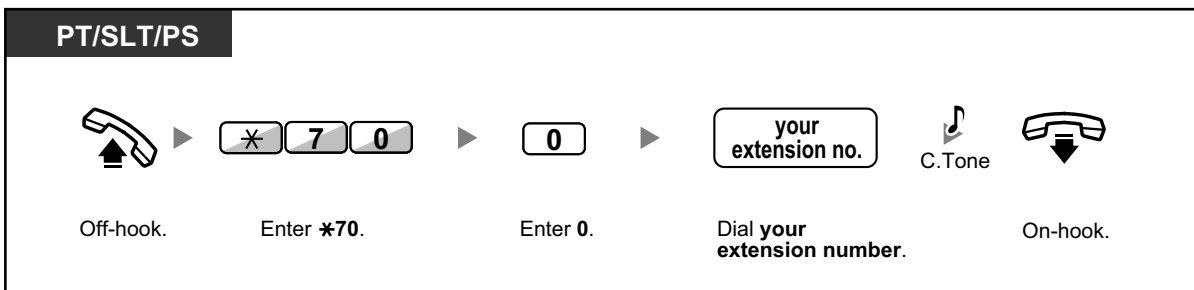



- The Message button light or Message/Ringer Lamp shows the current status as follows:  
**Off:** No message  
**Red on:** You have a message.
- The display shows the messages starting with the most recent call.
- At a called extension, the MESSAGE button allows you to clear message waiting indications if you do not want to call the callers back. To clear, press the MESSAGE button and then press the soft button. This operation cannot be performed using KX-UT series SIP phones or S-PSs.
- On your PT, you can establish one or more Message for Another Extension buttons. These buttons can accept the message waiting notification of other extensions or various incoming call distribution groups.  
 In other words, you can monitor the message waiting notifications of other telephones.
- A single line telephone extension user will receive a special dial tone as message waiting notification when going off-hook.
- The message waiting lamp of a single line telephone can also let you know that you have a message in the same way as the Message button.



### Customising Your Phone

- 3.1.3 Customising the Buttons  
 Create or edit a Message button or Message for Another Extension button.

## ◆◆ Joining an Existing Call (Executive Busy Override)

The preprogrammed extension can call someone who is busy on the telephone and establish a three-party conversation. After pressing a DSS button, you can check the caller information of the call to another extension on the display before establishing a three-party conversation.

### To join an intercom call

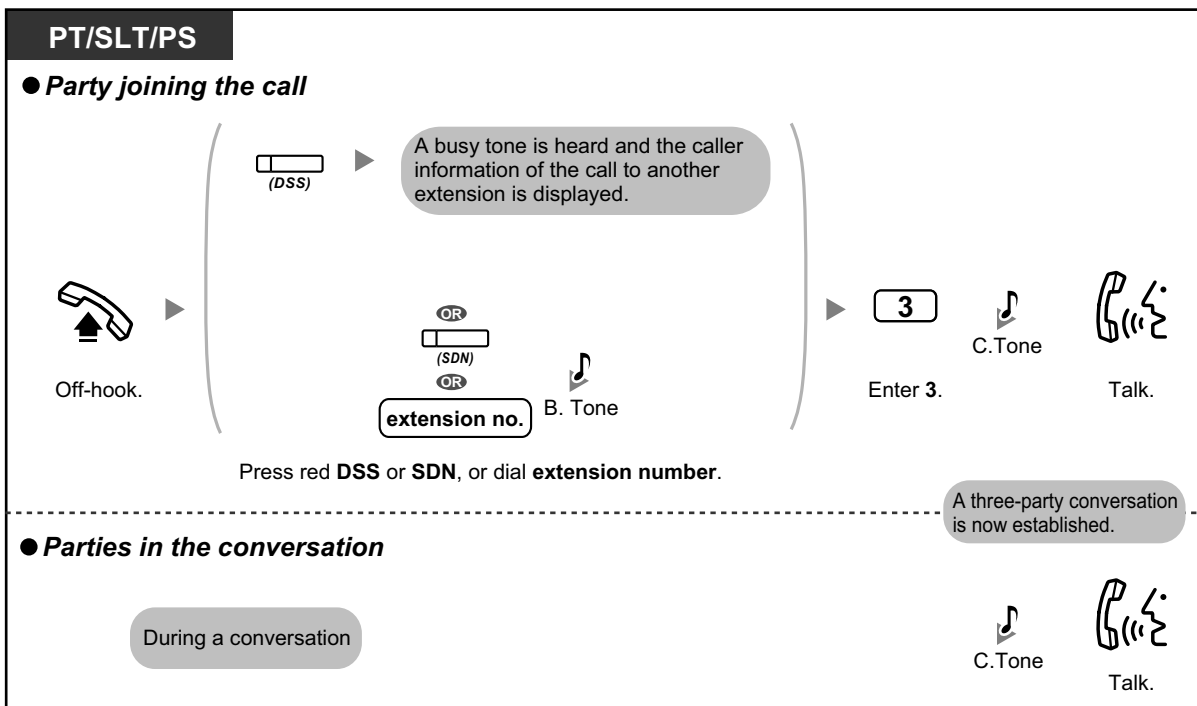

To join an outside call

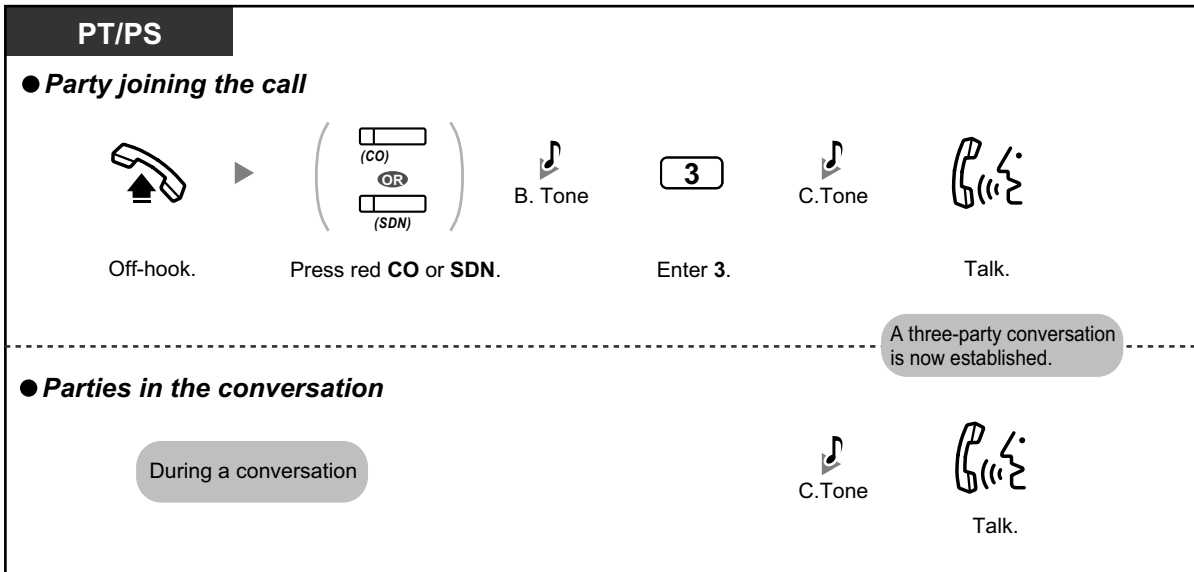

- SIP phone users cannot use this feature, but other extensions can call them using Executive Busy Override.
- To join another conversation, you must have Executive Busy Override enabled at your extension through COS programming.
- It is possible for an originating extension to leave a three-party conversation with an outside party and let the two other parties talk by simply going on-hook.

◆ For the originating extension

To talk to each party alternately

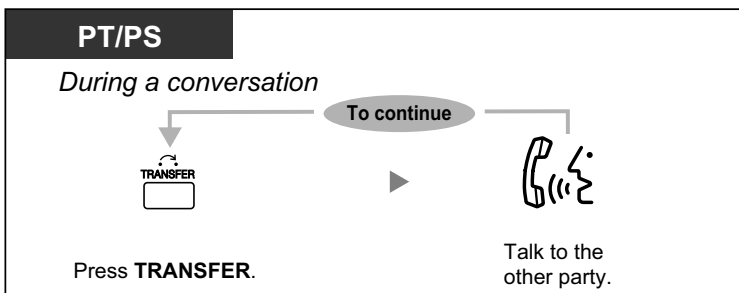

- You can also deny others the possibility of joining your conversation (Default: Allow). Refer to "1.9.7 Preventing Other People from Joining Your Conversation (Executive Busy Override Deny)".

## ◆◆ Monitoring Another Extension (Call Monitor)

The preprogrammed extension can monitor another extension. After pressing a DSS button, you can check the caller information of the call to another extension on the display. Then, you can choose to monitor the call, if necessary.

### To monitor

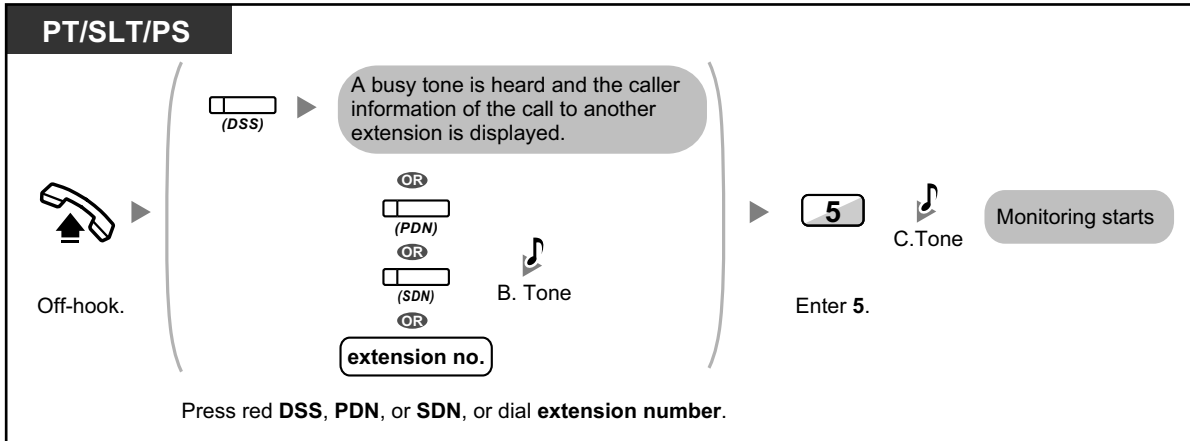

- SIP phone users cannot use this feature, but they can be monitored by other extensions.

## ◆◆ To an Extension Refusing the Call (DND Override)

The preprogrammed extension can call someone who has set the DND feature.

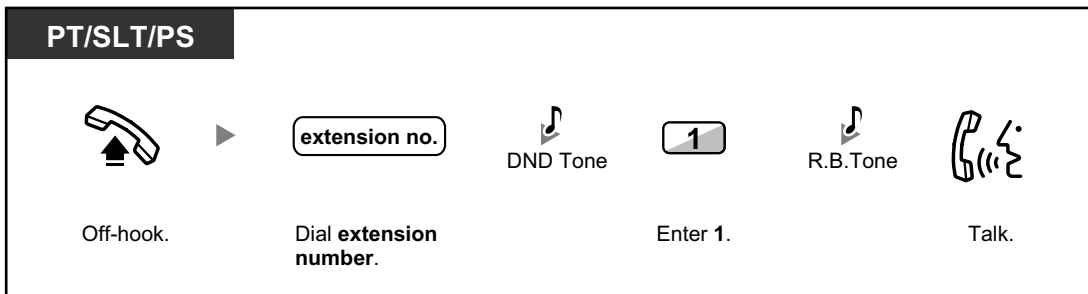

- SIP phone users cannot use DND Override to call someone who has set the DND feature, but can let other extensions call them using DND Override when the DND feature is set.

## 1.2.5 Accessing the ISDN Service (ISDN Service Access)

You can access services provided by the ISDN.



### To access

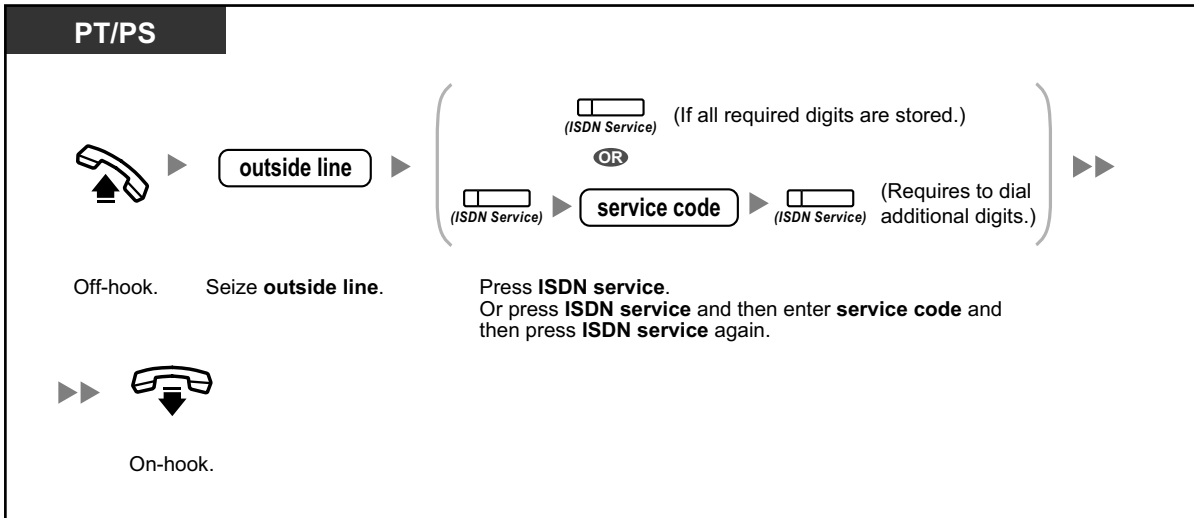

- Availability of features depends on the ISDN service of your telephone company.



### Customising Your Phone

- 3.1.3 Customising the Buttons  
Create or edit an ISDN Service button.



## 1.2.6 Alternating the Calling Method (Alternate Calling—Ring/Voice)

The caller can alternate the alerting method, either ring or voice, when making an intercom call.

On the other hand, any extension can set the alerting method, either ring or voice, when receiving an intercom call.

**Ringing (Default):** You can call the other party with a ring tone.

**Voice-calling:** You can talk to the other party immediately after confirmation tone.

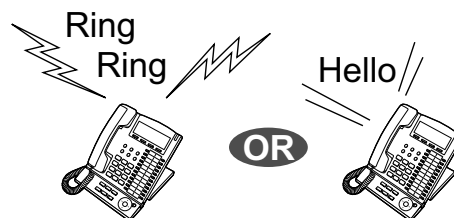

### To change the method

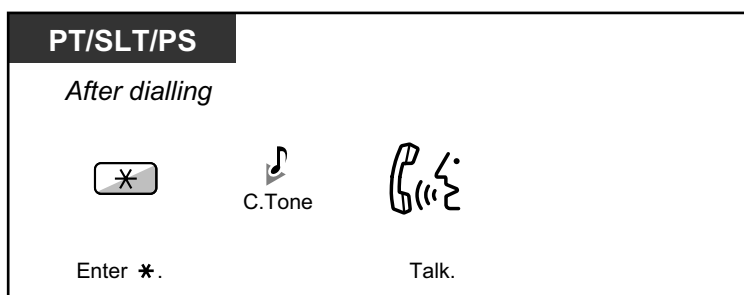

- Voice-calling from a SIP extension is not available.
- If the called party uses a SIP extension, single line telephone (SLT) or portable station (PS), Voice-calling is not available.
- This feature is not available when the called party's telephone is in the Voice Call Deny mode.



### Customising Your Phone

- 3.1.2 Settings on the Programming Mode—**Alternate Receiving—Ring/Voice**  
Select the alerting method, either ring or the other party's voice.

## 1.2.7 Calling without Restrictions

- ♦♦ Using Your Calling Privileges at Another Extension (Remote COS Access)

### ♦♦ Using Your Calling Privileges at Another Extension (Remote COS Access)

You can use your calling privileges (Class of Service) at another extension. You may override restrictions which have been set. To use this feature, an original extension number and an extension PIN (Personal Identification Number) are required. You can make a call by entering a verification code and verification code PIN.

#### To call (Walking COS)

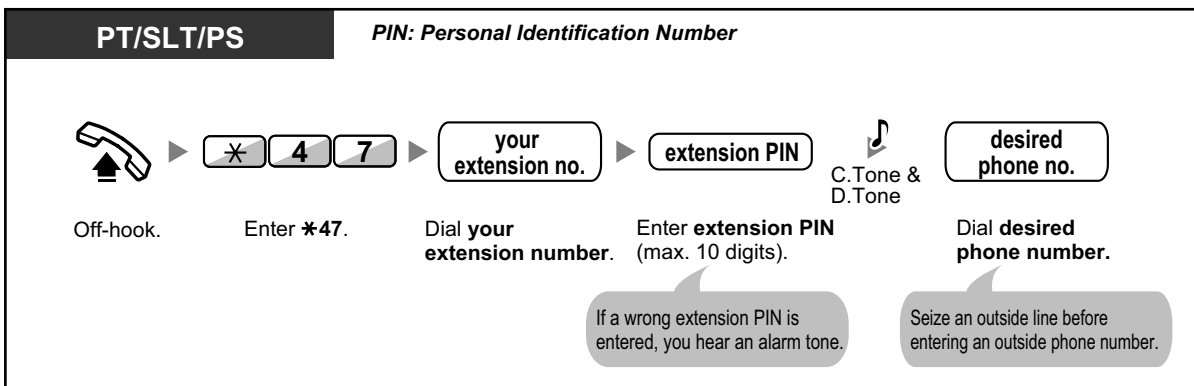

#### To call with a verification code (Verification Code Entry)

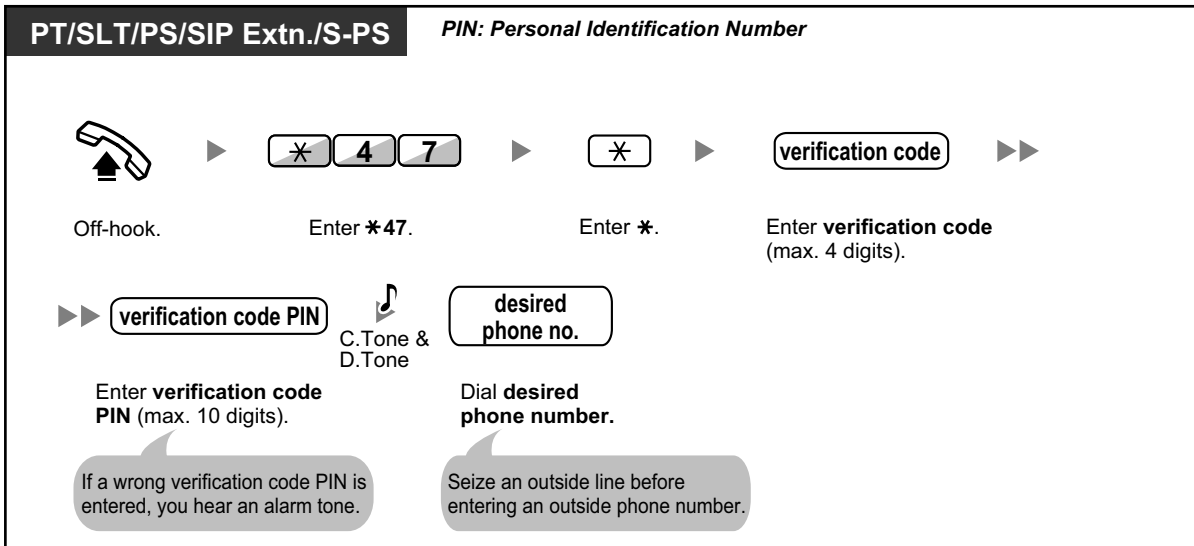

## 1.2.8 To Access Another Party Directly from Outside (Direct Inward System Access [DISA])

- ♦♦ Calling through DISA

### ♦♦ Calling through DISA

When outside callers access extensions in the PBX, a prerecorded message greets the caller and gives information about how to access an extension. You do not need the operator's assistance.

You may be able to access system features or call an outside party with your password depending on the security mode.

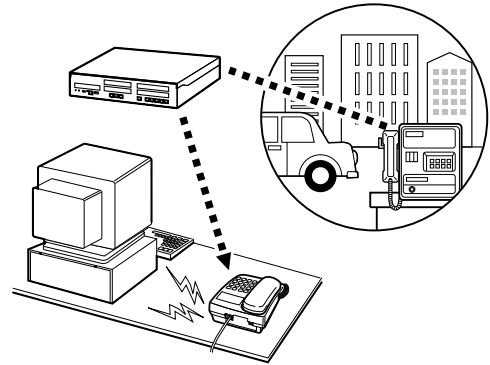

#### To call an extension

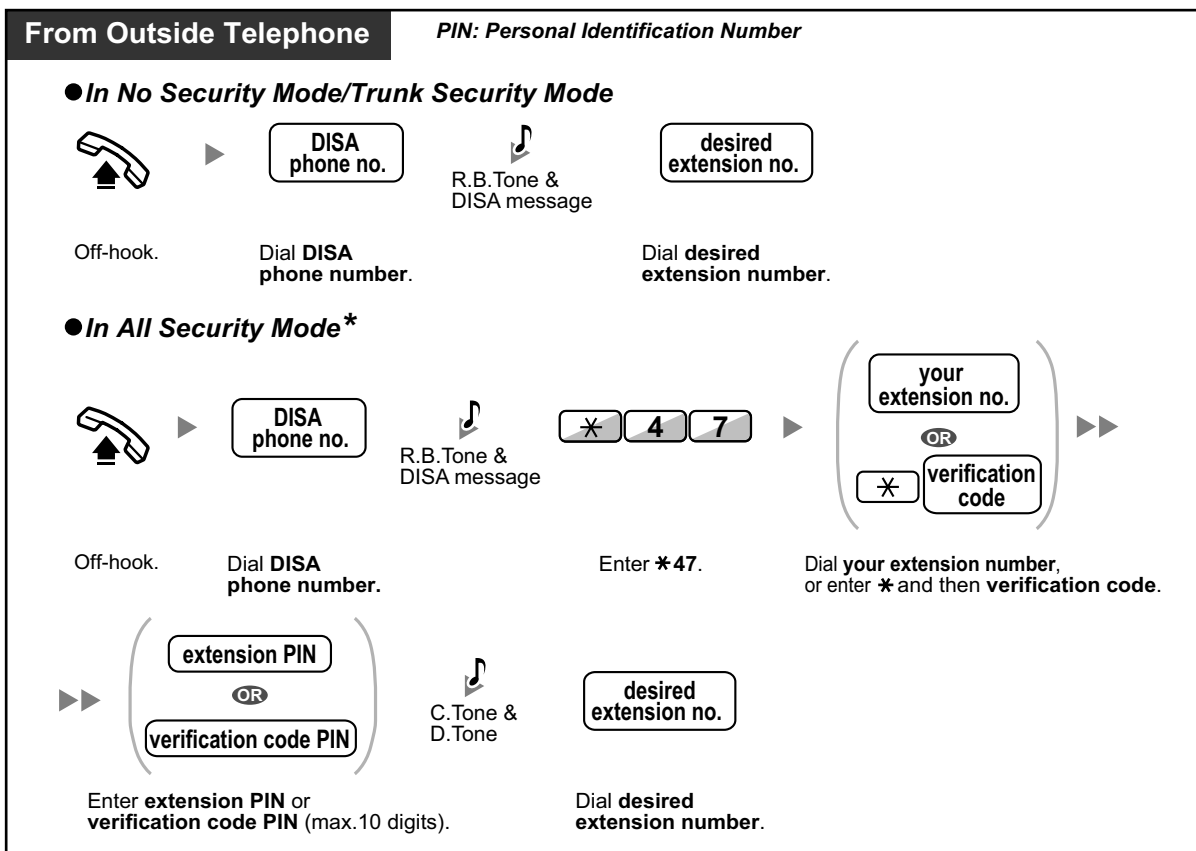

To call an outside party

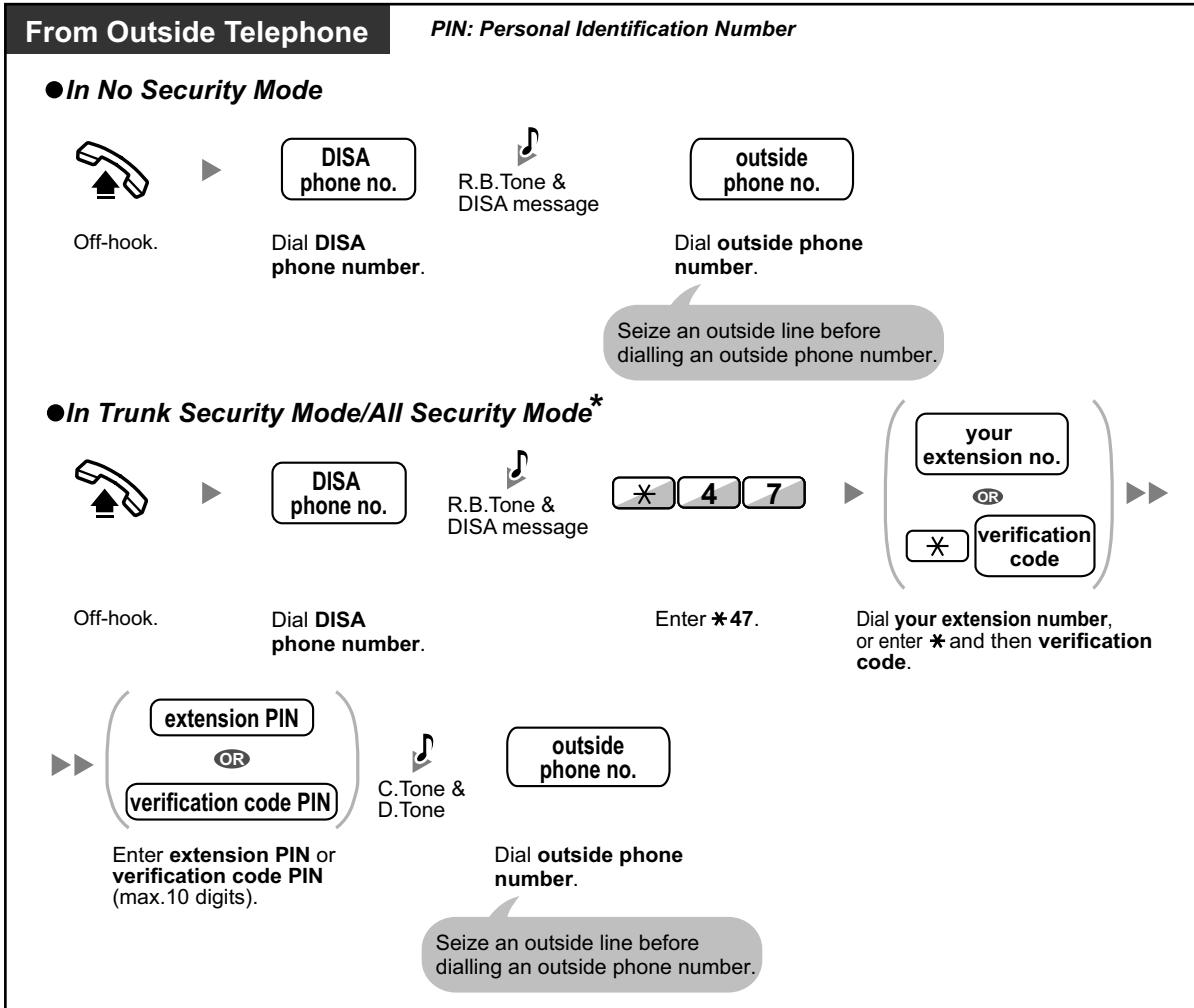

- \* Callers from preprogrammed outside numbers can access the PBX through DISA without a password (extension PIN/verification code PIN) (**DISA Automatic Walking COS**).
- When making an outside call using Walking COS through DISA, the CLIP number for that call will be that of the extension seized by Walking COS.

To retry

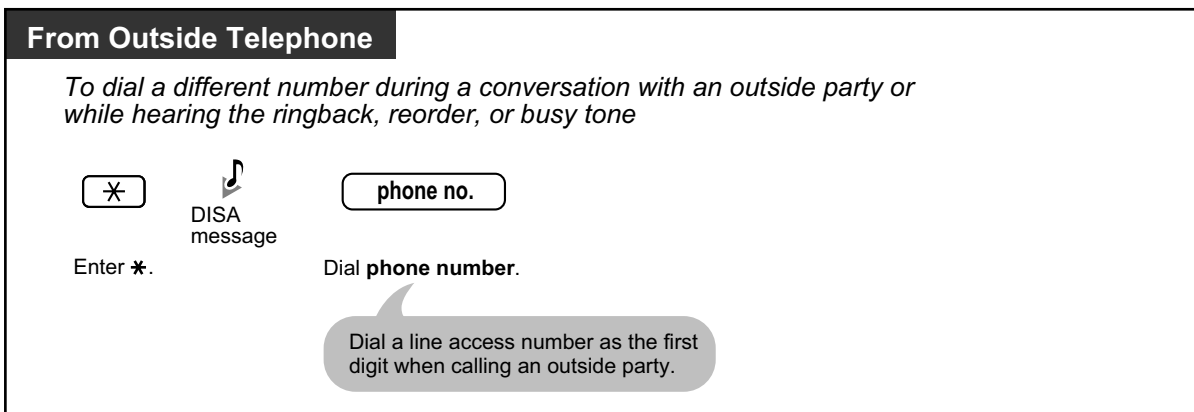



### **CAUTION**

There is a risk that fraudulent telephone calls will be made using the Outside-to-Outside Call feature of DISA.

The cost of such calls will be billed to the owner/renter of the PBX.

To protect the PBX from this kind of fraudulent use, we strongly recommend:

- a.** Enabling DISA security (Trunk Security or All Security).
  - b.** Keeping your passwords (verification code PIN/extension PIN) secret.
  - c.** Selecting complex, random PINs that cannot be easily guessed.
  - d.** Changing PINs regularly.
- **Time limit**  
Both parties will hear an alarm tone fifteen seconds before the specified time limit. To extend, press any dial button except \*.
  - **If Built-in Automated Attendant service is set**, you can access the desired extension simply by pressing a single digit (0–9) from the options given the prerecorded message.

## 1.2.9 Setting Your Telephone from Another Extension or through DISA (Remote Setting)

You can set the following features on your telephone from another extension or through DISA.

- Call Forwarding (FWD)/Do Not Disturb (DND)
- Changing the Log-in/Log-out Status of Extensions
- Absent Message
- Extension Dial Lock
- Time Service—Changing the Time Mode (Day/Night/Lunch/Break)

### From another extension

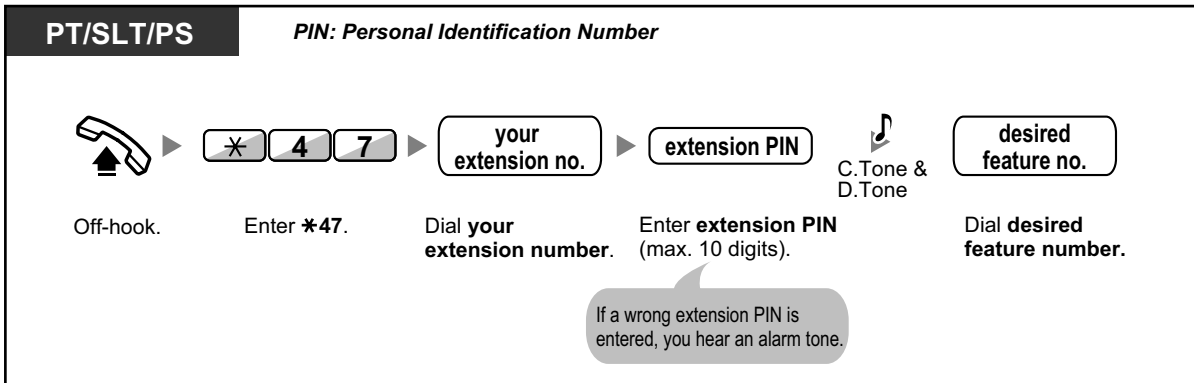

### Through DISA

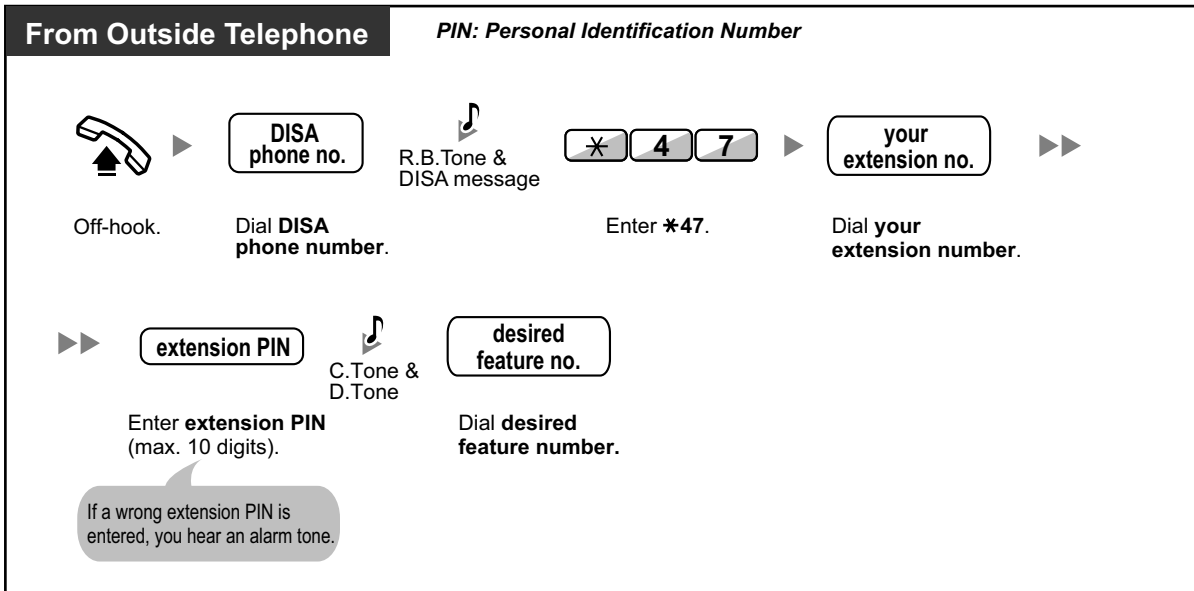

## 1.3 Receiving Calls

### 1.3.1 Answering Calls

**PT/SLT/PS/SIP Extn./S-PS**



Off-hook.

▶



Talk.

Select one of the following methods:

- Lift the handset to receive the preferred line.  
(Default: Ringing line is selected.)
- Press the SP-PHONE button.
- Press the flashing CO, INTERCOM, ICD Group, PDN, SDN, or DN button directly.
- Press the ANSWER button.



- **Hands-free Operation**

You can receive a call and have a conversation in hands-free mode using the SP-PHONE button. KX-UT133/KX-UT136/KX-UT248 users can have a conversation in hands-free mode by pressing the flashing CO or DN button.



- **Customising Your Phone**

- 3.1.2 Settings on the Programming Mode—

- **Preferred Line Assignment—Incoming**

Select the seized line when going off-hook.

- **Alternate Receiving—Ring/Voice**

Select the alerting method, either ring or the other party's voice.

- 3.1.3 Customising the Buttons

Create or edit an Incoming Call Distribution Group (ICD Group), Primary Directory Number (PDN), or Secondary Directory Number (SDN) button.

## 1.3.2 Answering Hands-free (Hands-free Answerback)

You can answer an incoming call without going off-hook as soon as the line is connected. When an intercom call arrives, you will hear the caller talking without the phone ringing. When an outside call arrives, you will hear the caller talking after a preprogrammed number of rings. Hands-free Answerback for outside calls requires system programming.



### To set/cancel



- PT users: The AUTO ANS button light shows the current status as follows:  
**Off:** Not set  
**Red on:** Set
- KX-UT series SIP phone (except KX-UT670) users: When Hands-free Answerback is set, the AUTO ANS icon appears on the display.
- PS, S-PS, and KX-UT670 users: Refer to the documentation for your phone.



## 1.3.3 Answering a Call Ringing at Another Telephone (Call Pickup)

- ♦♦ Answering a Call from Another Telephone (Call Pickup)
- ♦♦ Denying Other People the Possibility of Picking Up Your Calls (Call Pickup Deny)

### ♦♦ Answering a Call from Another Telephone (Call Pickup)

You can answer an incoming call that is ringing at another extension or group from your phone without leaving your desk.

The following types of pickup are available:

**Group Call Pickup:** Picks up a call within your group.

**Directed Call Pickup:** Picks up a specified extension's call.

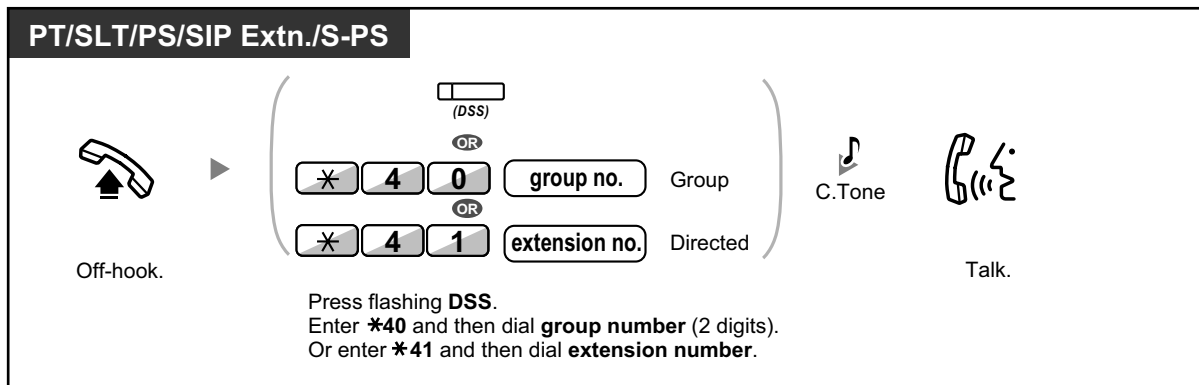

### Caller Information Display before Call Pickup using DSS button

Depending on system programming, you can confirm the caller information of a call to another extension using the DSS button before picking up the call. Pressing the corresponding DSS button will call the extension receiving the call rather than picking up the call. While hearing the busy tone, you can check the caller information on the display. You can pick up the call by pressing the same DSS button again.

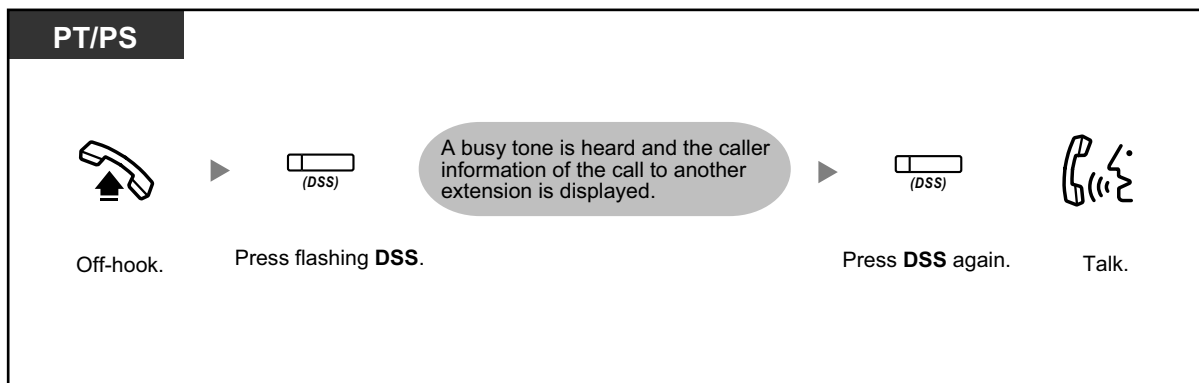

- **If you receive a call waiting tone**, you can ask a third party to pick up your second call with Directed Call Pickup.

### ◆◆ Denying Other People the Possibility of Picking Up Your Calls (Call Pickup Deny)

You can deny or allow other people to pick up your calls.

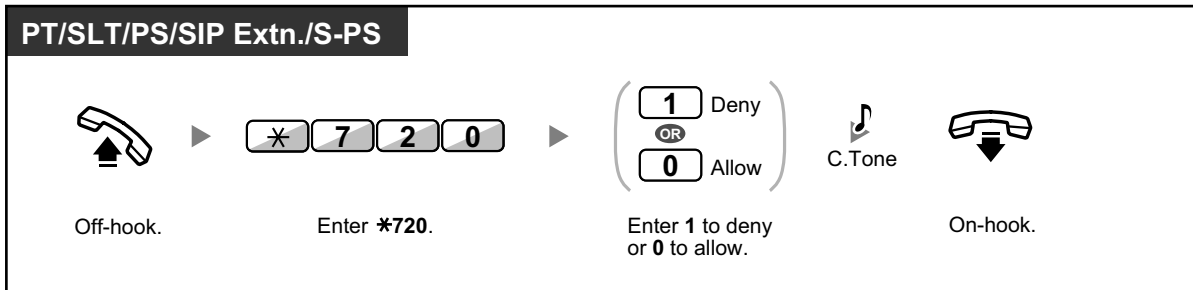

## 1.3.4 Answering a Call via an External Speaker (Trunk Answer From Any Station [TAFAS])

You can be notified of incoming outside calls through an external speaker. These calls can be answered from any extension.

### Through an external speaker

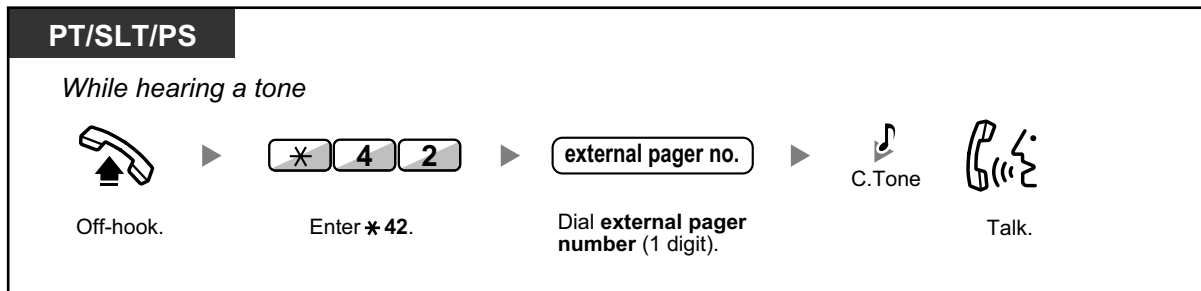

- You can also receive a paging announcement via a speaker with this operation.

## 1.3.5 Using the ANSWER/RELEASE Button

The ANSWER and RELEASE buttons are convenient for operators using headsets. With the ANSWER button, you can answer all incoming calls. With the RELEASE button, you can disconnect the line during or after a conversation, or complete transferring a call.



### To answer



### To transfer a call

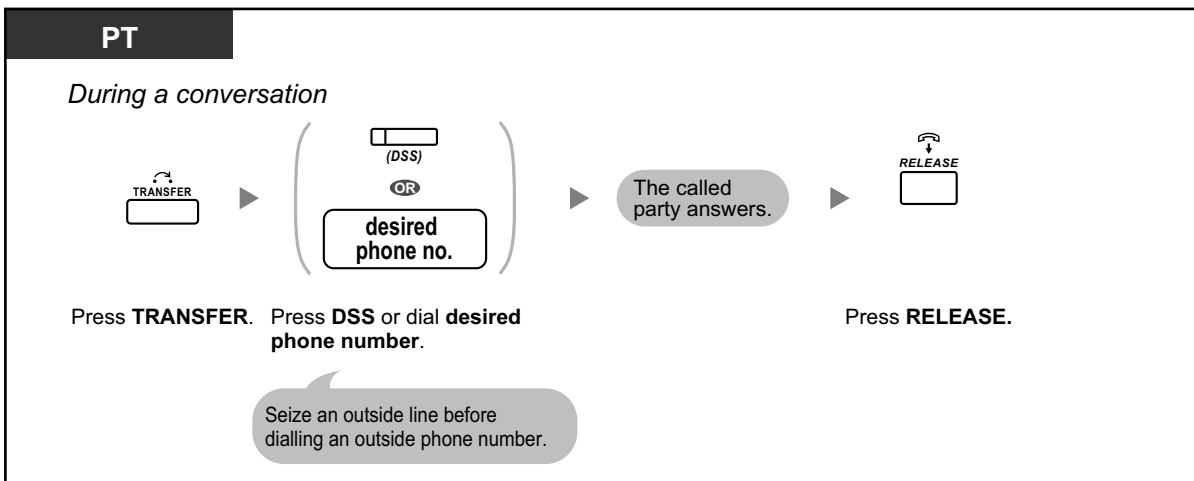

### To talk to a waiting caller

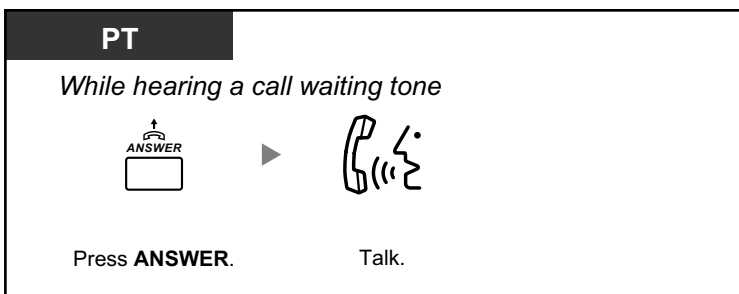

### To transfer an outside call to an extension with a one-touch operation

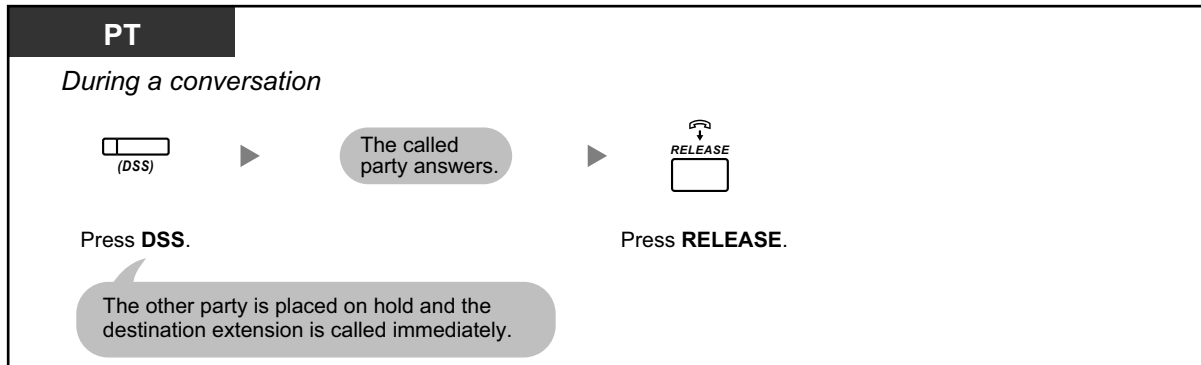

### To end a conversation

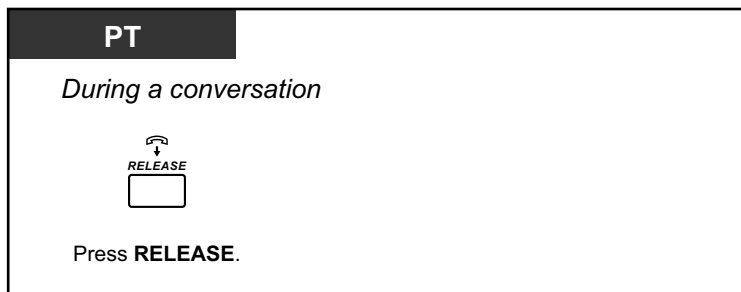

#### Customising Your Phone

- 3.1.3 Customising the Buttons  
Create or edit an Answer button or a Release button.

## 1.3.6 Identifying Malicious Calling Parties (Malicious Call Identification [MCID])

You can ask your telephone company to trace a malicious calling party during a conversation or after the calling party hangs up.

You will receive the information on the malicious call later on.

### To request MCID

**PT/SLT/PS**

*During a conversation or when hearing a reorder tone after the calling party hangs up.*

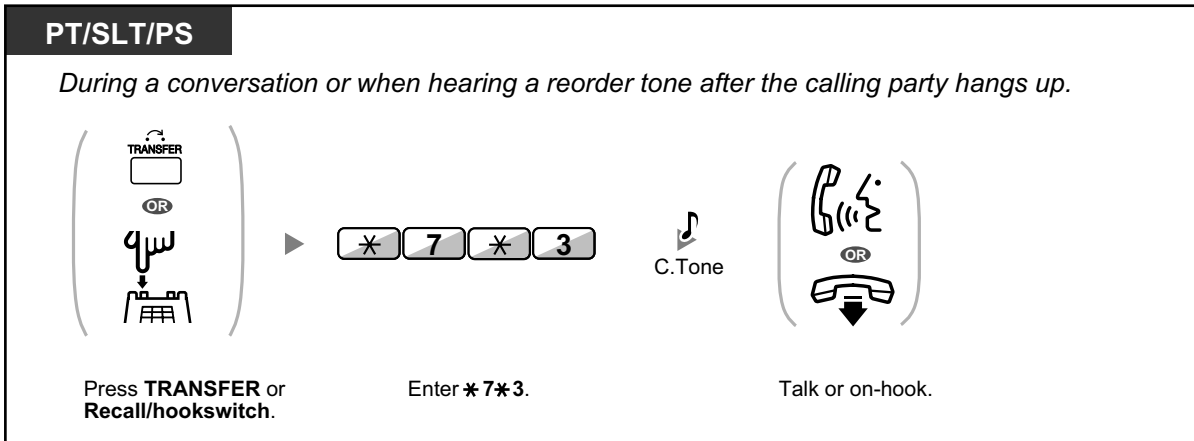

The diagram illustrates the process of requesting Malicious Call Identification (MCID). It is divided into three main stages:

- Step 1:** Press **TRANSFER** or **Recall/hookswitch**. This is represented by a telephone handset icon with a curved arrow above it labeled "TRANSFER", and a telephone handset icon with a downward arrow below it labeled "Recall/hookswitch".
- Step 2:** Enter **\*7\*3**. This is represented by four rectangular buttons containing the asterisk (\*), the number 7, another asterisk (\*), and the number 3.
- Step 3:** Talk or on-hook. This is represented by a telephone handset icon with a downward arrow below it, and a telephone handset icon with a curved arrow above it.

Between the first and second stages, there is a right-pointing arrow. Between the second and third stages, there is a musical note icon labeled "C.Tone".

Below the diagram, the text "Press **TRANSFER** or **Recall/hookswitch**." is aligned under the first stage, "Enter **\*7\*3**." is aligned under the second stage, and "Talk or on-hook." is aligned under the third stage.



- Availability of this feature depends on the ISDN service of your telephone company.

## 1.4 During a Conversation

### 1.4.1 Transferring a Call (Call Transfer)

- ◆◆ Transferring to an Extension in the PBX
- ◆◆ Transferring to an Outside Party Using the PBX Service
- ◆◆ Transferring a Call Using the ISDN Service (Call Transfer [CT]—by ISDN)
- ◆◆ Transferring to an Outside Party Using the SIP Service



- You can transfer a held call without talking, and go on-hook even if the transferred party does not answer the call.  
If a transferred call is not answered within a specified time, it will ring at a preprogrammed extension, if set, or at your extension again. If you are off-hook at that time, you will hear an alarm tone. If an outside call is not answered within a specified time, it is automatically disconnected.
- **For users of non-KX-UT series SIP phones:**
  - Even if your telephone has a TRANSFER button, you cannot use it to transfer calls. Please make sure to use the HOLD button.
  - The transfer operation for SIP extension users may differ from the steps in this section, and may vary depending on the type of telephone being used.
  - **Blind Transfer**  
Blind Transfer may be available on your phone. For details about using Blind Transfer, refer to the documentation for your SIP phone. (This feature is not available when transferring to an outside party using the SIP service.)

### ◆◆ Transferring to an Extension in the PBX

To transfer

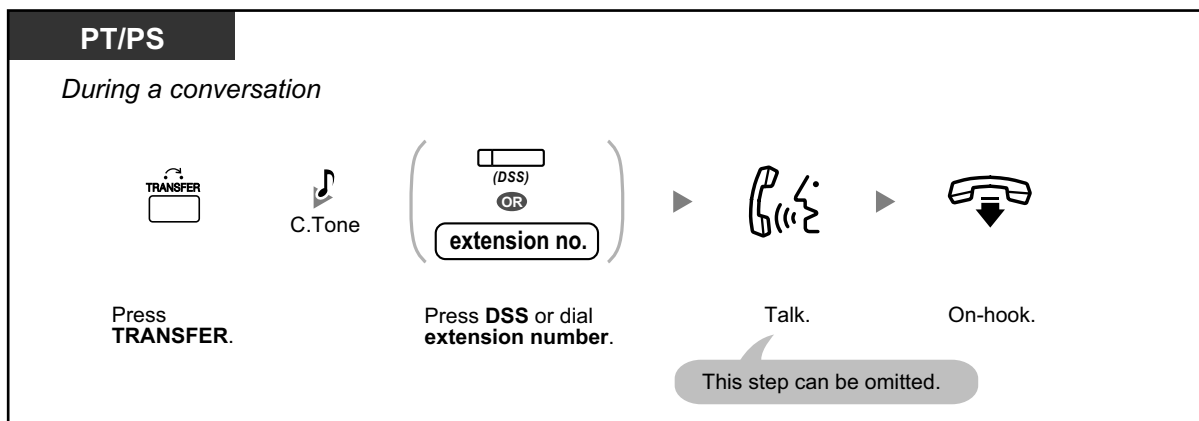

### 1.4.1 Transferring a Call (Call Transfer)

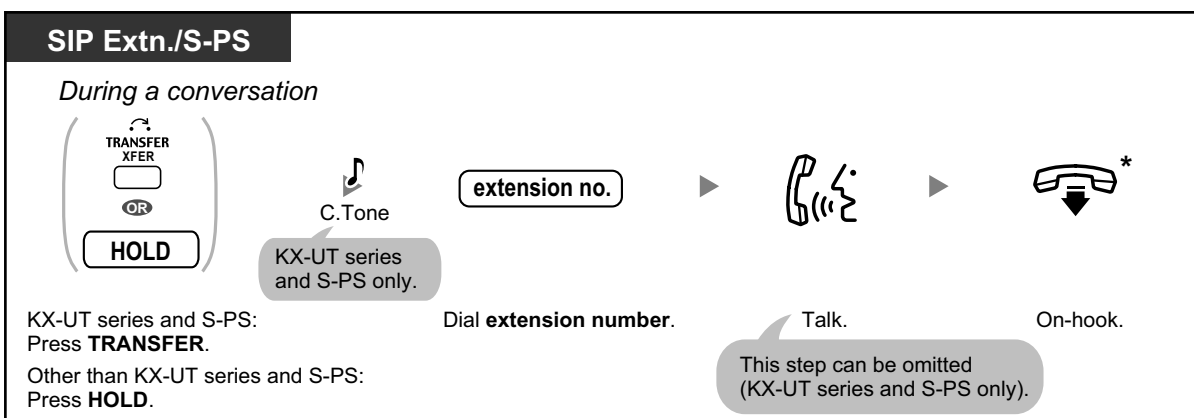
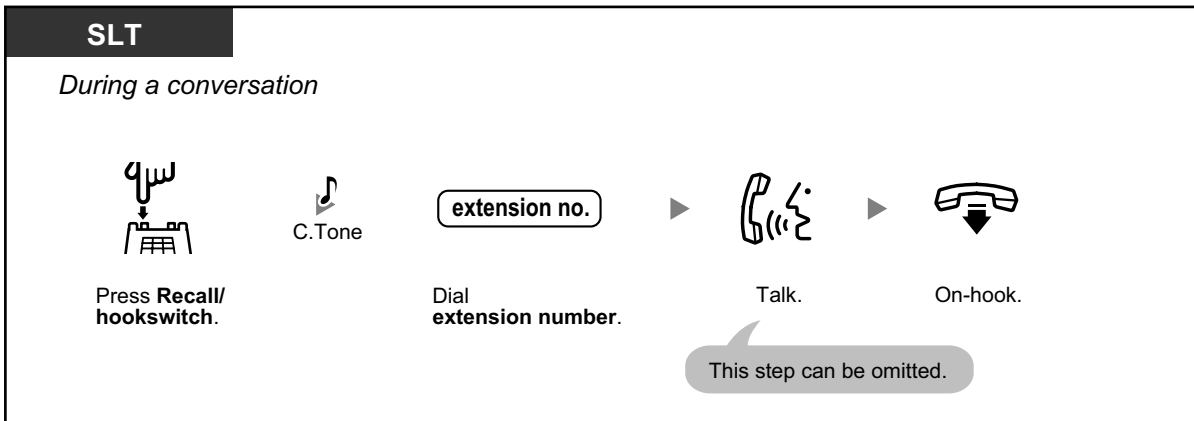

- \* For SIP phone users, instead of going on-hook, if you press the TRANSFER button (KX-UT series [except KX-UT670]), Transfer Cancel button (KX-UT670) once, or the HOLD button (non-KX-UT series) once or twice (depending on the telephone being used), you can return to the held call. The call with the transferred party will be disconnected.
- If the call is not transferred within a specified time, you will hear an alarm (Transfer Recall).



- For the transfer operation using an SDN button, refer to "1.5.1 Primary Directory Number (PDN)/Secondary Directory Number (SDN) Extension".

#### To transfer with one touch (One-touch Transfer)

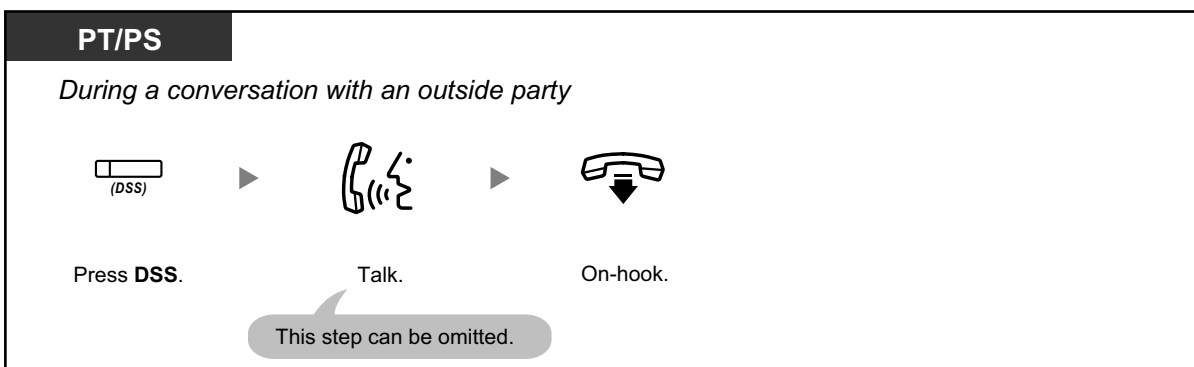





- System programming is required to use the One-touch Transfer feature during a conversation with an extension.

## ◆◆ Transferring to an Outside Party Using the PBX Service

Some extensions may be restricted from performing this feature.

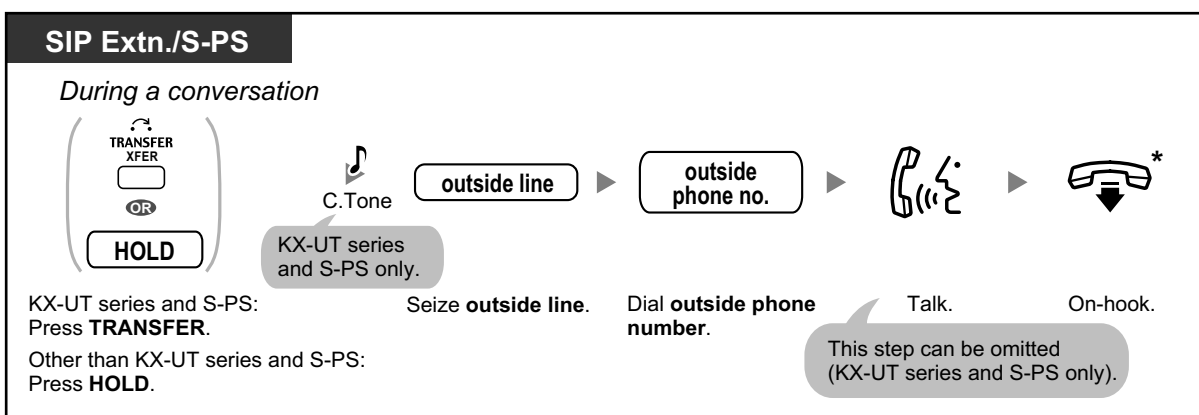
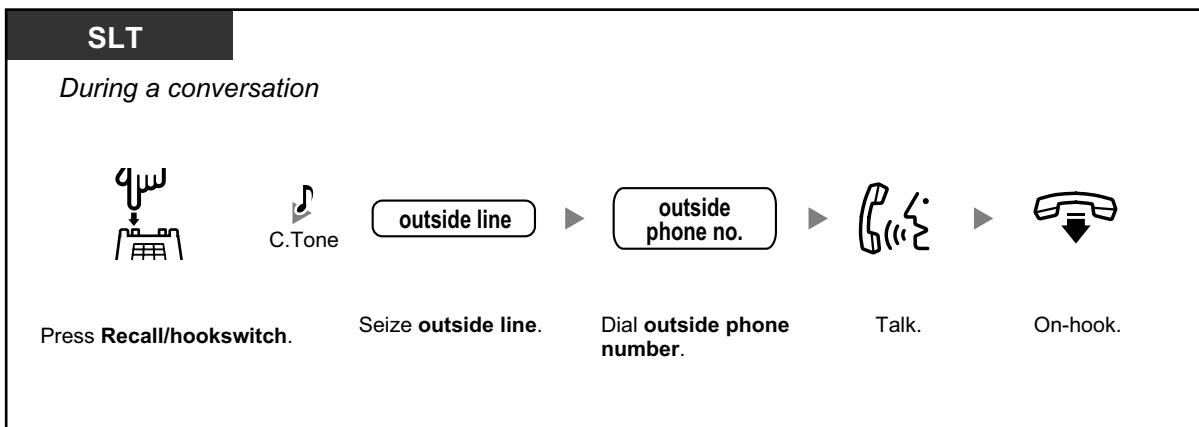
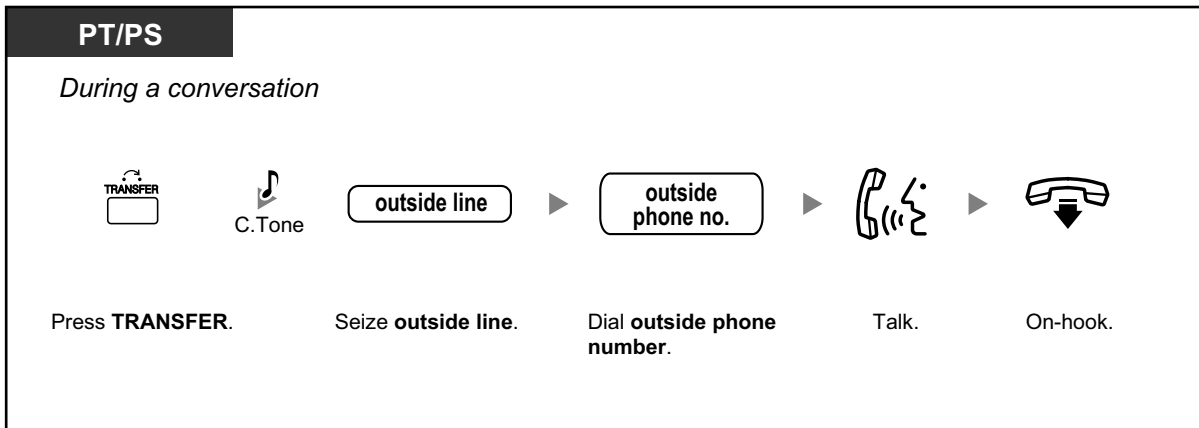

### 1.4.1 Transferring a Call (Call Transfer)



- \* For SIP phone users, instead of going on-hook, if you press the TRANSFER button (KX-UT series [except KX-UT670]), Transfer Cancel button (KX-UT670) once, or the HOLD button (non-KX-UT series) once or twice (depending on the telephone being used), you can return to the held call. The call with the transferred party will be disconnected.
- **Time limit**  
Both the caller and the transferred party will hear an alarm tone fifteen seconds before a specified time period, and the call will be disconnected.
- **To return to the held call before the destination answers**, press the TRANSFER button, the corresponding CO, ICD Group, INTERCOM, or DN button, or the hookswitch.



#### Customising Your Phone

- 3.1.3 Customising the Buttons  
Create or edit a Direct Station Selection (DSS) button.

### ◆◆ Transferring a Call Using the ISDN Service (Call Transfer [CT]—by ISDN)

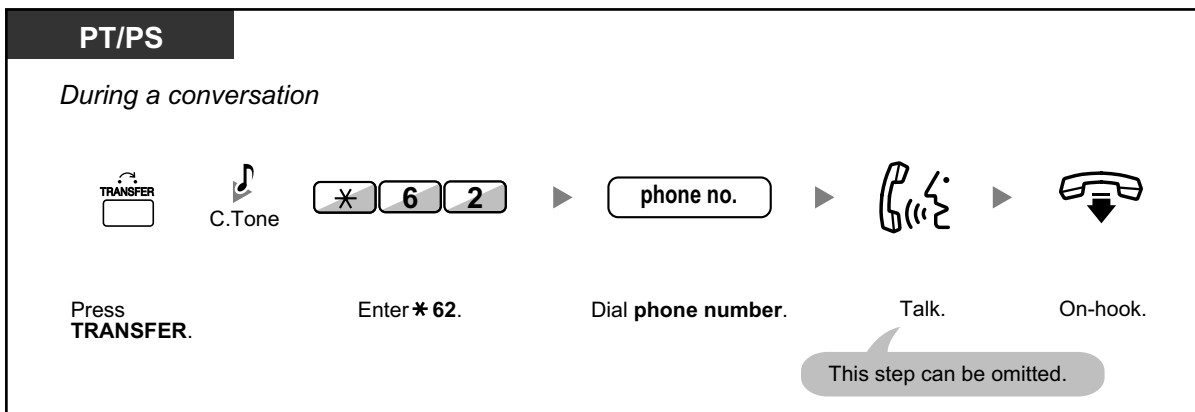
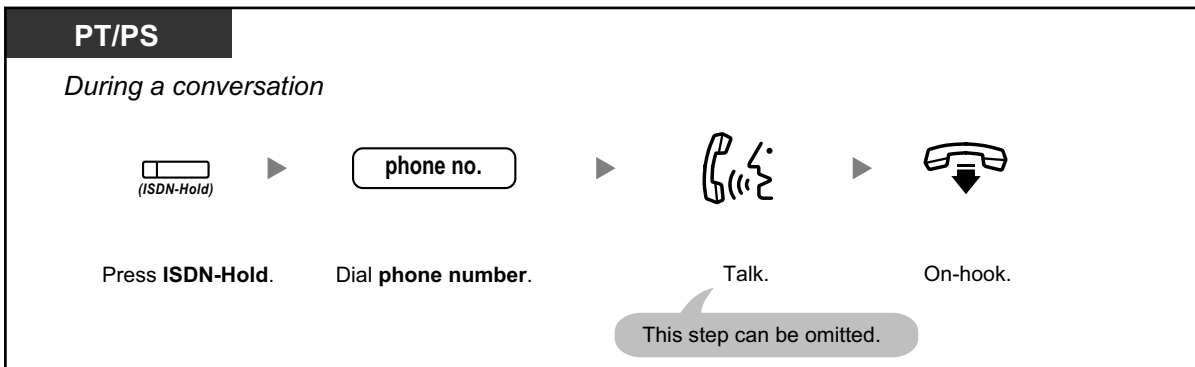

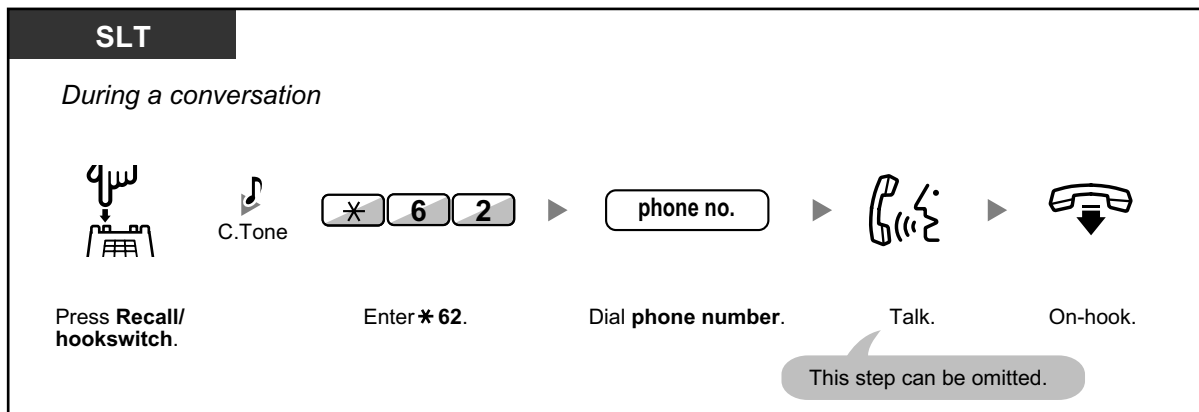

- To retrieve the held call, press the TRANSFER button, Recall/hookswitch.
- Even if you go on-hook while transferring a call, it is transferred.
- After the call is transferred, the line becomes idle.



### Customising Your Phone

- 3.1.3 Customising the Buttons  
Create or edit an ISDN-Hold button.

## ◆◆ Transferring to an Outside Party Using the SIP Service

To transfer a call with announcement (Attended Transfer)

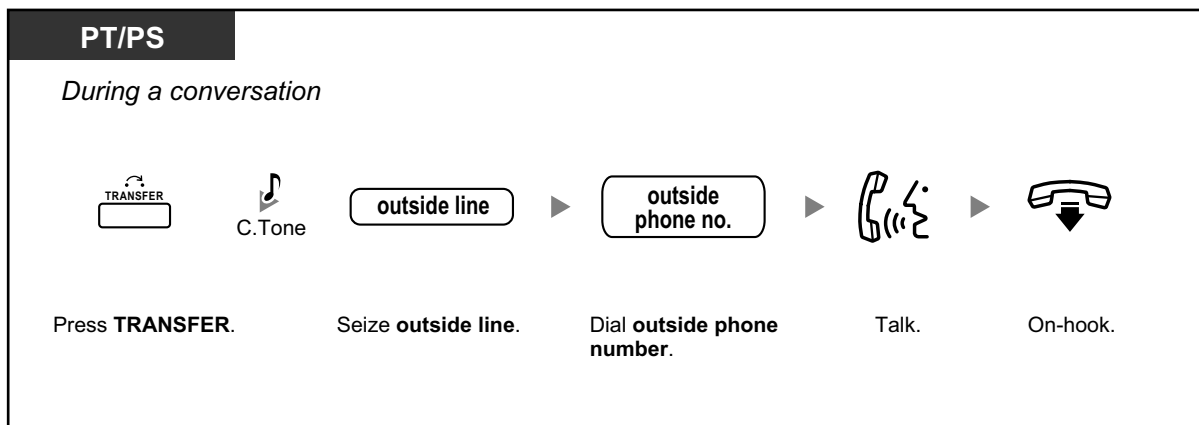

### 1.4.1 Transferring a Call (Call Transfer)

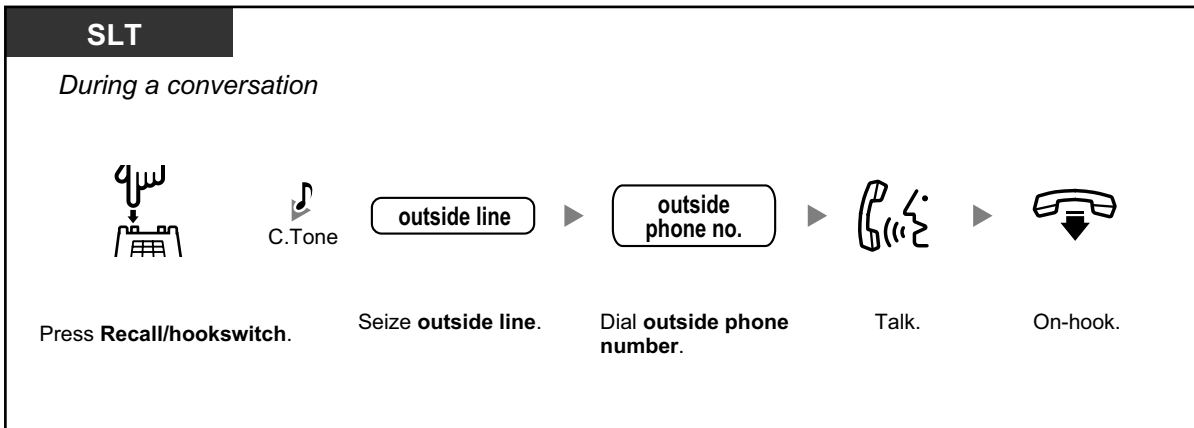

#### To transfer a call without announcement (Blind Transfer)

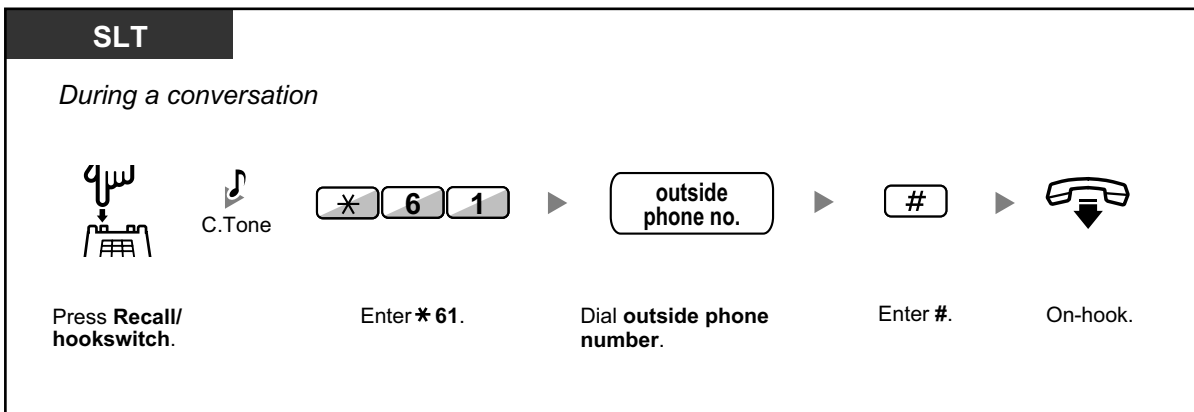
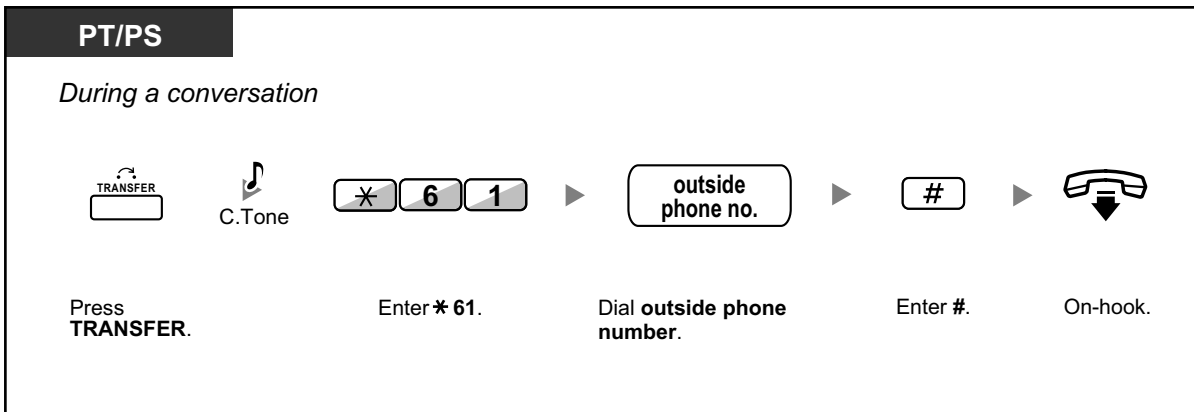

- The availability of this feature depends on your SIP service provider.
- You cannot return to the held call after dialling the destination's number.



#### Customising Your Phone

- 3.1.3 Customising the Buttons  
Create or edit a One-touch Dialling button, store the Blind Transfer feature number.

## 1.4.2 Holding a Call

- ◆◆ Holding
- ◆◆ Holding in a System Parking Zone (Call Park)



- **For users of non-KX-UT series SIP phones:**  
The holding operation for SIP extension users may differ from the steps in this section, and may vary depending on the type of telephone being used.

### ◆◆ Holding

There are two types of hold. The difference between them is that other people can retrieve your held call (Regular Hold) or not (Exclusive Call Hold). As they can be alternated, ask your manager what the current mode is.

#### To hold (Call Hold)

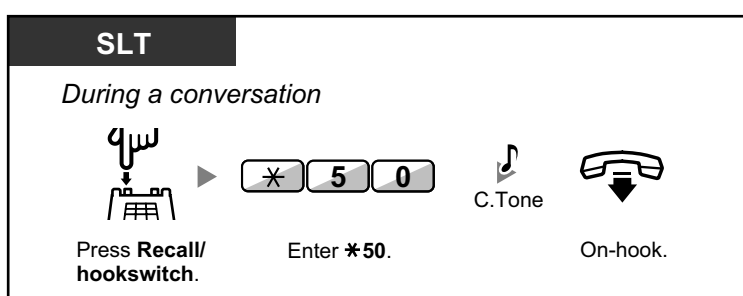
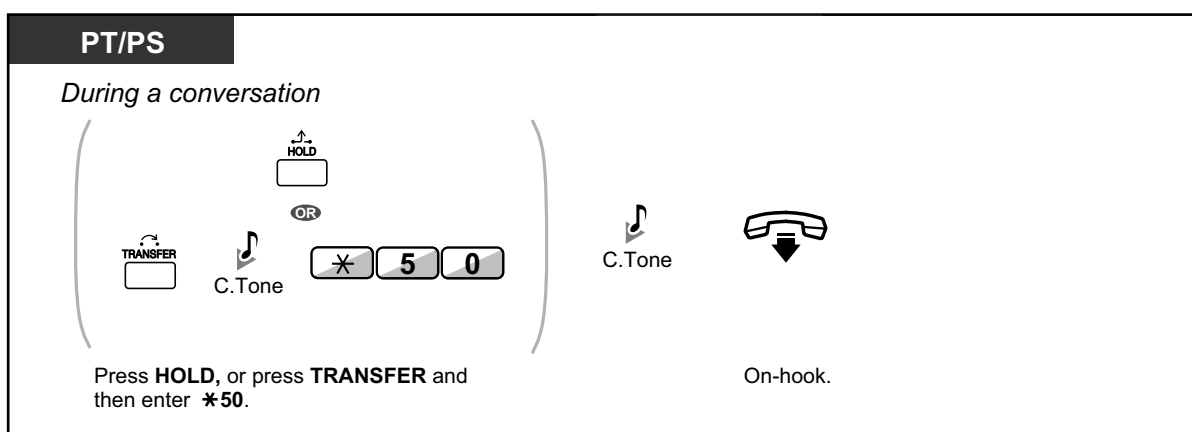

To retrieve a call (Call Hold Retrieve)

**PT/SLT/PS**

- **At the holding extension (Call Hold Retrieve)**

Off-hook. Press flashing **CO** or **INTERCOM**, or enter **\* 50**. A confirmation tone is heard. Talk.
- **To retrieve an outside call from another extension—only Regular Hold (Call Hold Retrieve—Specified with a held line number)**

Off-hook. Press **CO**, or enter **\* 53** and then **held line number** (3 digits). A confirmation tone is heard. Talk.
- **To retrieve an intercom call or outside call from another extension—only Regular Hold (Call Hold Retrieve—Specified with a holding extension number)**

Off-hook. Enter **\* 51**. Press **DSS** or dial **holding extension number**. C. Tone. Talk.

## SIP Extn./S-PS

- **At the holding extension (Call Hold Retrieve)**

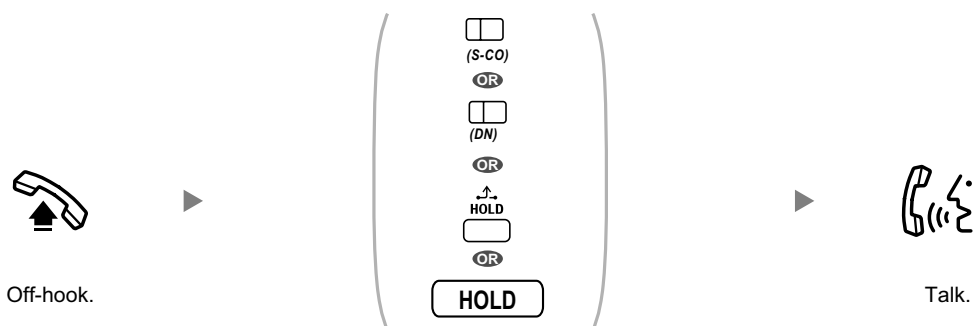

KX-UT133/KX-UT136/KX-UT248/KX-UT670/S-PS:  
Press flashing **S-CO** or **DN**.

Other than KX-UT133/KX-UT136/KX-UT248/KX-UT670/S-PS:  
Press **HOLD**.

- **To retrieve an outside call from another extension—only Regular Hold (Call Hold Retrieve—Specified with a held line number)**

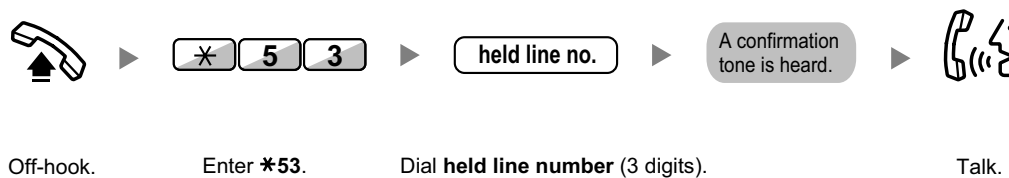

- **To retrieve an intercom call or outside call from another extension—only Regular Hold (Call Hold Retrieve—Specified with a holding extension number)**

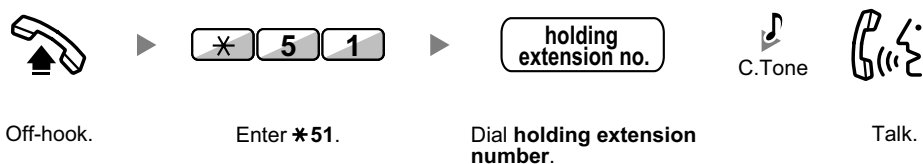

## 1.4.2 Holding a Call



- For PT users: The CO or INTERCOM button light shows the current status as follows:
  - Regular Hold mode
    - Flashing green slowly:** Your held call
    - Flashing red:** Another extension's held call
  - Exclusive Call Hold mode
    - Flashing green moderately:** Your held call
    - Red on:** Another extension's held call
- For KX-UT133/KX-UT136/KX-UT248/KX-UT670 SIP phone users: The S-CO button light shows the current status as follows:
  - Regular Hold mode
    - Flashing green slowly:** Your held call
    - Flashing red:** Another extension's held call
- **If a call is not retrieved within a specified time**, you will hear an alarm as a reminder (Hold Recall).  
If an outside call is not answered within a specified time, it is automatically disconnected.
- **Hold Mode Change (PT only)**  
After pressing the HOLD button, if you press the HOLD button again, the status switches from the Regular Hold mode to the Exclusive Call Hold mode or from the Exclusive Call Hold mode to the Regular Hold mode.



- If **Automatic Call Hold** has been preprogrammed, you can put the current call on hold automatically by pressing another CO, ICD Group, INTERCOM, or DN button to make or answer another call.
- For the Call Hold Retrieve operation using a PDN/SDN button, refer to "1.5.1 Primary Directory Number (PDN)/Secondary Directory Number (SDN) Extension".

### ◆◆ Holding in a System Parking Zone (Call Park)

You can put a call on hold in a common parking zone of the PBX so that any extension can retrieve the parked call. You can use this feature as a transferring feature.

A call can be put into either a specified parking zone (Specified) or any idle parking zone (Auto). If a Call Park button and Call Park (Automatic Park Zone) button have been established, you can select either way to park by simply pressing the corresponding button.

When a call is parked automatically, or more than one call has been parked at the same time, you need to specify the parking zone number to retrieve the required call.

#### To set

**PT/PS/KX-UT133/KX-UT136/KX-UT248/KX-UT670/S-PS**

*During a conversation*

  
(Call Park)

Press **Call Park**.



**PT/PS**

*During a conversation*

Press **TRANSFER**.      Enter **\*52**.      Enter a specified **parking zone number** (2 digits) or press **\*** to park at an idle parking zone automatically.

( parking zone no. Specified )  
OR  
( \* Auto )

C.Tone      On-hook.

If you hear a busy tone, enter another parking zone number or press **\*** again.

**SLT**

*During a conversation*

Press **Recall/hookswitch**.      Enter **\*52**.      Enter a specified **parking zone number** (2 digits).

( parking zone no. )

C.Tone      On-hook.

If you hear a busy tone, enter another parking zone number.

**To retrieve (Call Park Retrieve)**

**PT/PS/KX-UT133/KX-UT136/KX-UT248/KX-UT670/S-PS**

(Call Park)

Press a flashing **Call Park**.

**PT/SLT/PS/SIP Extn./S-PS**

Off-hook.      Enter **\*52**.      Dial **stored parking zone number** (2 digits).      C.Tone      Talk.

( stored parking zone no. )



- If a call is parked automatically, confirm the parking zone number on the display.
- **If a call is not retrieved within a specified time**, you will hear an alarm as a reminder (Call Park Recall).  
If an outside call is not answered within a specified time, it is automatically disconnected.
- For SIP phone users: Any SIP phone user can retrieve a parked call, but only KX-UT133/KX-UT136/KX-UT248/KX-UT670 SIP phone users can put a call into a parking zone.
- The Call Park button light shows the current status as follows:  
**Flashing red (for PT)**: You or another extension has a call parked.  
**Flashing red (for KX-UT133/KX-UT136/KX-UT248/KX-UT670)**: Another extension has a call parked.  
**Flashing green (for KX-UT133/KX-UT136/KX-UT248/KX-UT670)**: You have a call parked.



- **If you hear a reorder tone when retrieving a parked call**, there is no held call. Confirm the stored parking zone number.
- After you park a call, you can perform other operations.



### Customising Your Phone

- 3.1.3 Customising the Buttons  
Create or edit a Call Park button or Call Park (Automatic Park Zone) button.

## 1.4.3 Talking to Two Parties Alternately (Call Splitting)

When talking to one party while the other party is on hold, you can swap the calls back and forth (alternately).



- KX-UT series SIP phone and S-PS users: You cannot leave the conversation and let the two remaining parties talk.

To alternate between the parties leaving one party on hold temporarily

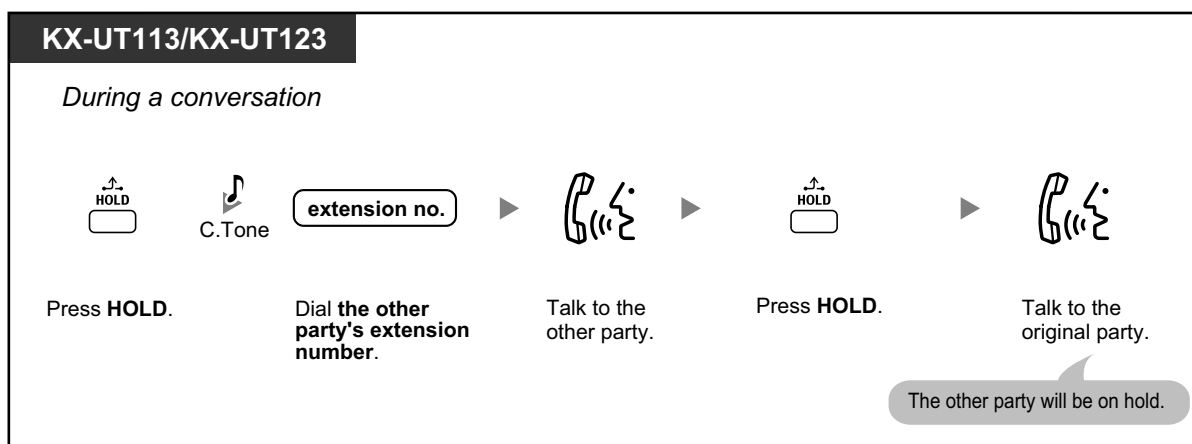
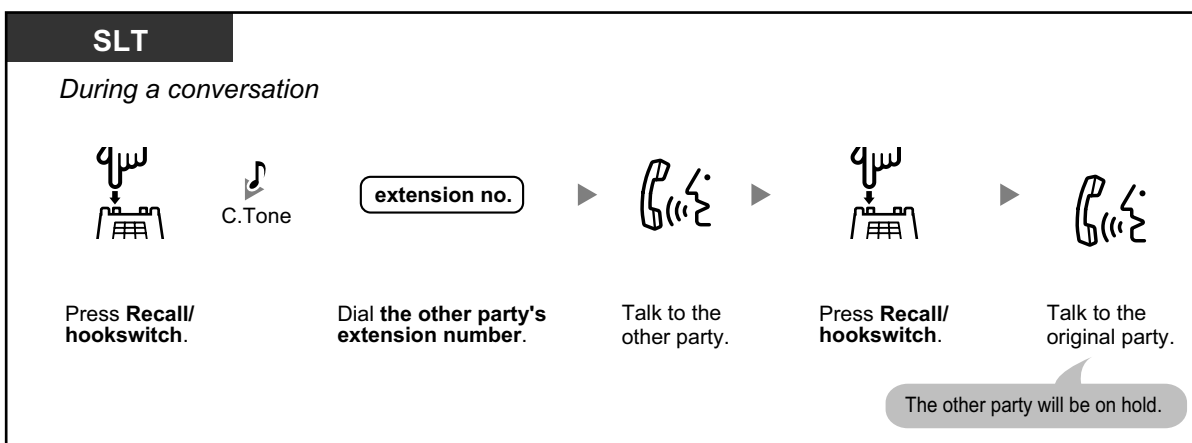
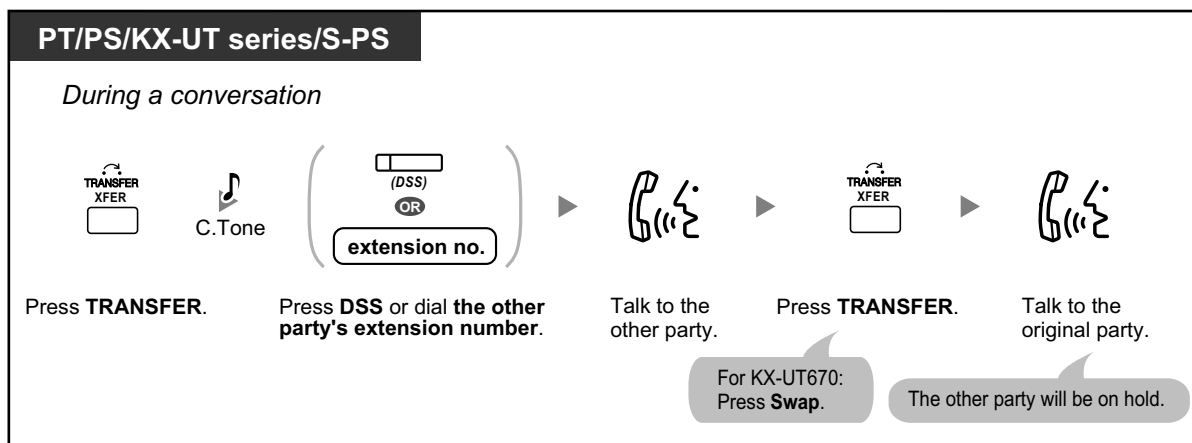

### 1.4.3 Talking to Two Parties Alternately (Call Splitting)

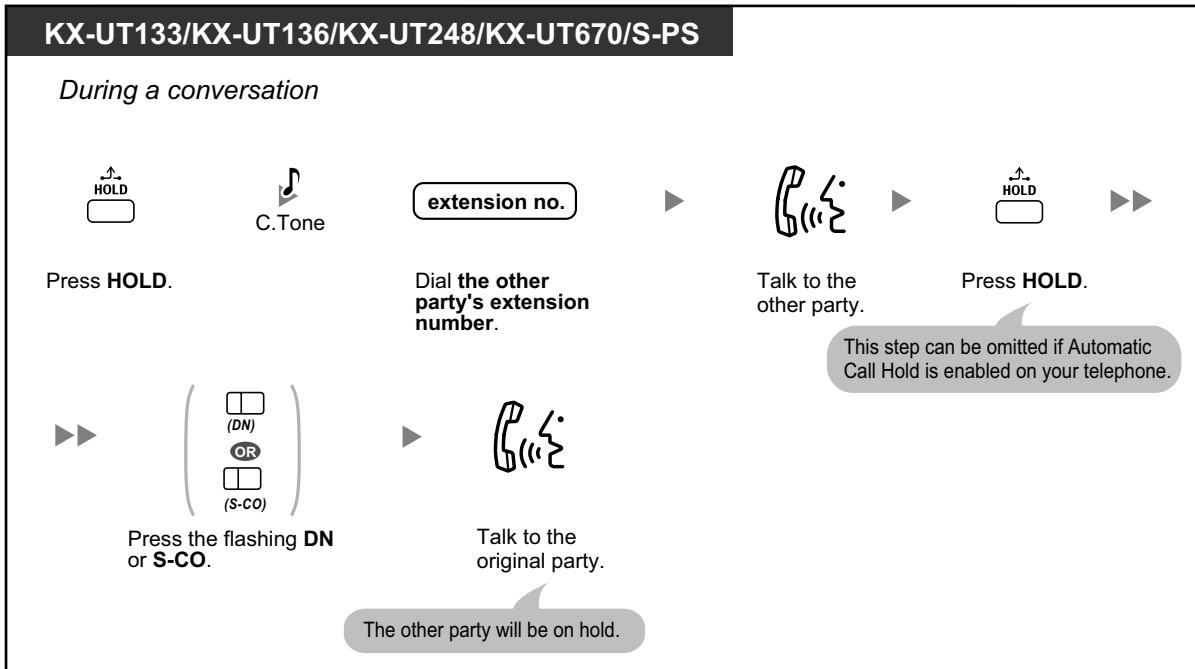

### To leave the conversation and then let the two parties talk

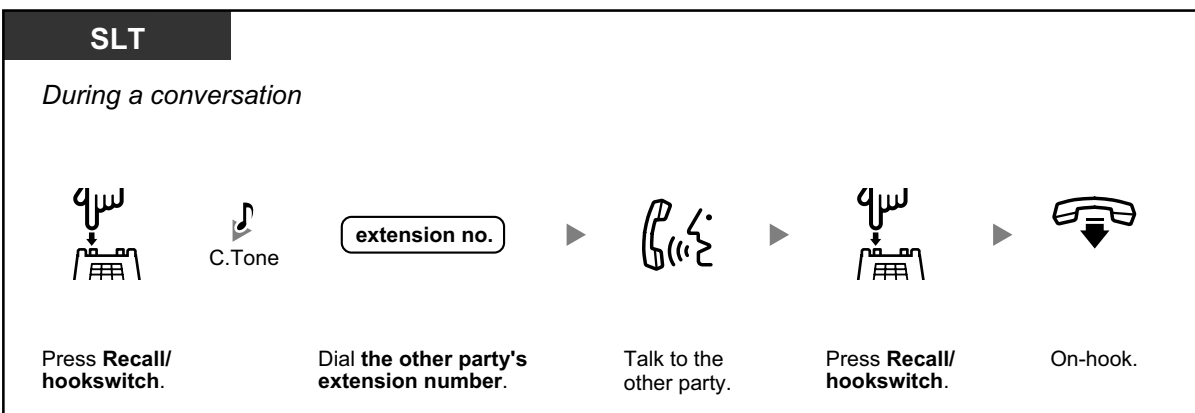
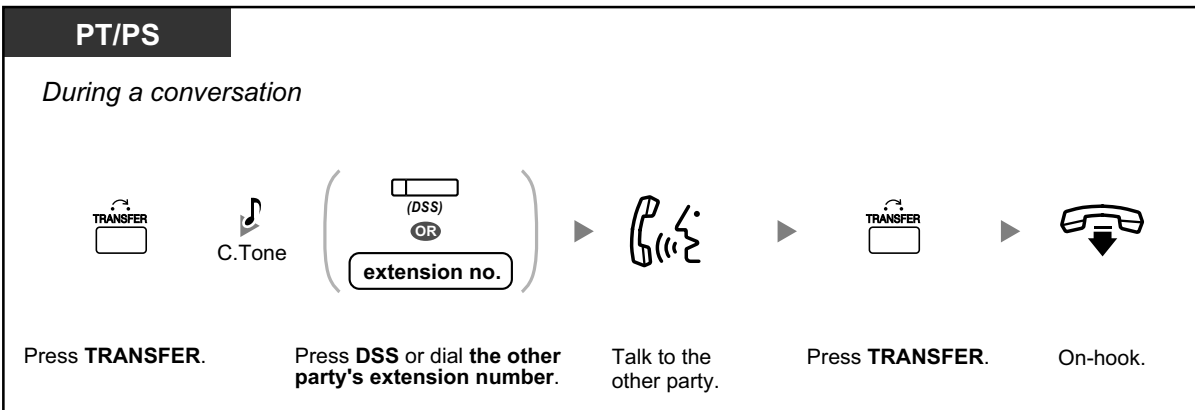

## 1.4.4 Answering Call Waiting

- ◆◆ Answering Call Waiting in the PBX
- ◆◆ Answering Call Waiting from the Telephone Company

### ◆◆ Answering Call Waiting in the PBX

During a conversation, a call waiting tone or voice announcement through the speaker or the handset occurs when an outside call has been received or another extension is letting you know a call is waiting. You must activate this feature to use it. (Default: Disable—No call [Intercom calls]/No tone [Outside calls])

**You can answer the second call by disconnecting (1) or holding (2) the current call.**

#### 1. To disconnect the current call and then talk to the new party



#### 2. To hold the current call and then talk to the new party

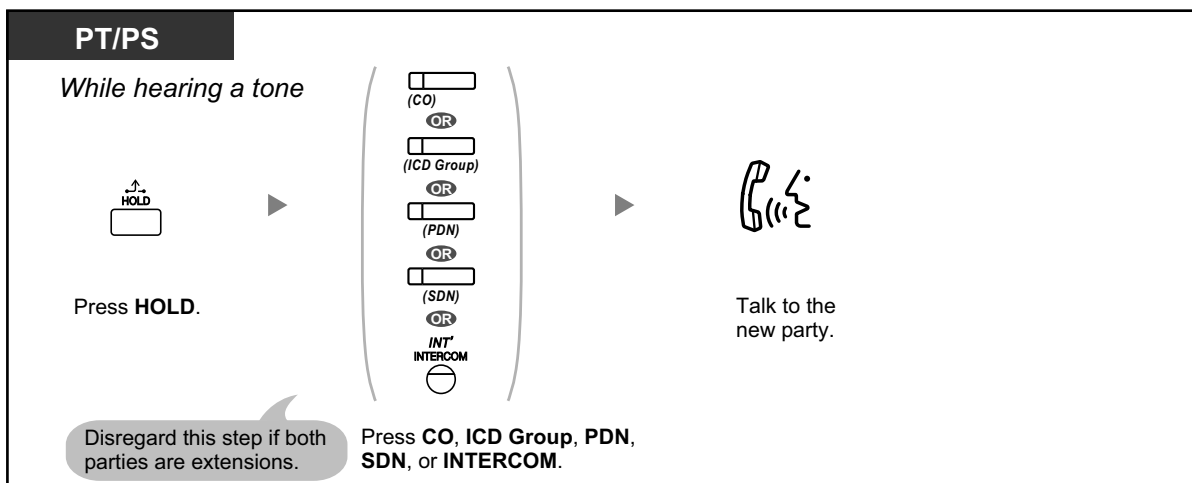

## 1.4.4 Answering Call Waiting

**SLT**

*While hearing a tone*

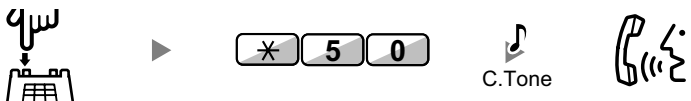

Press **Recall/hookswitch**.      Enter **\* 50**.      C.Tone      Talk to the new party.

**KX-UT113/KX-UT123**

*While hearing a tone*



Press **HOLD**.      C.Tone      Talk to the new party.

**KX-UT133/KX-UT136/KX-UT248/KX-UT670/S-PS**

*While hearing a tone*

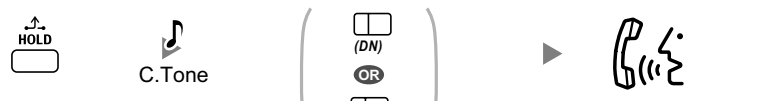

Press **HOLD**.      C.Tone      Press the flashing **DN**, or **S-CO**.      Talk to the new party.

**After talking to the new party (second call), you can disconnect (2.1) or hold (2.2) it and then retrieve the first call.**

2.1 To disconnect the second call and then talk to the original party

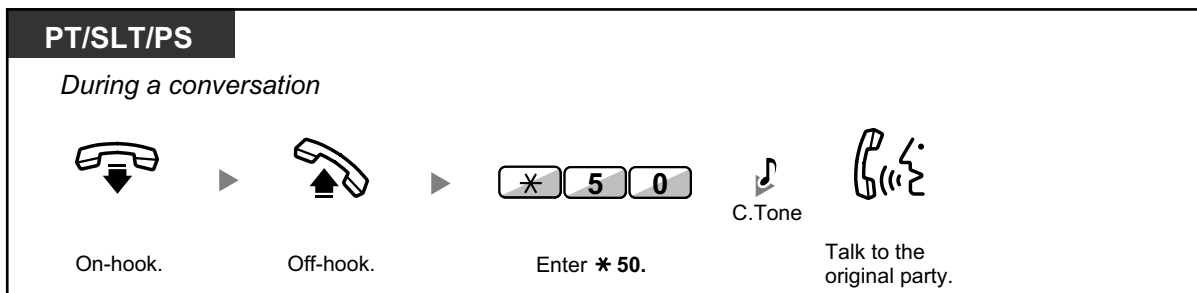
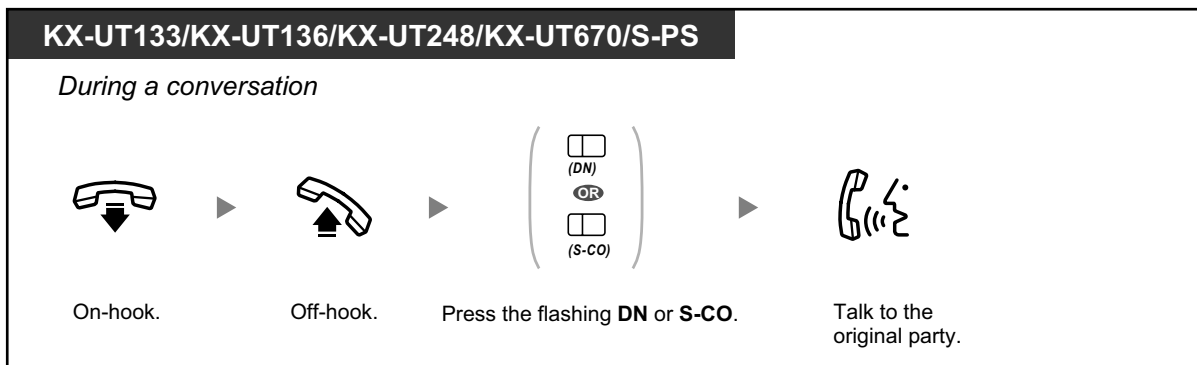
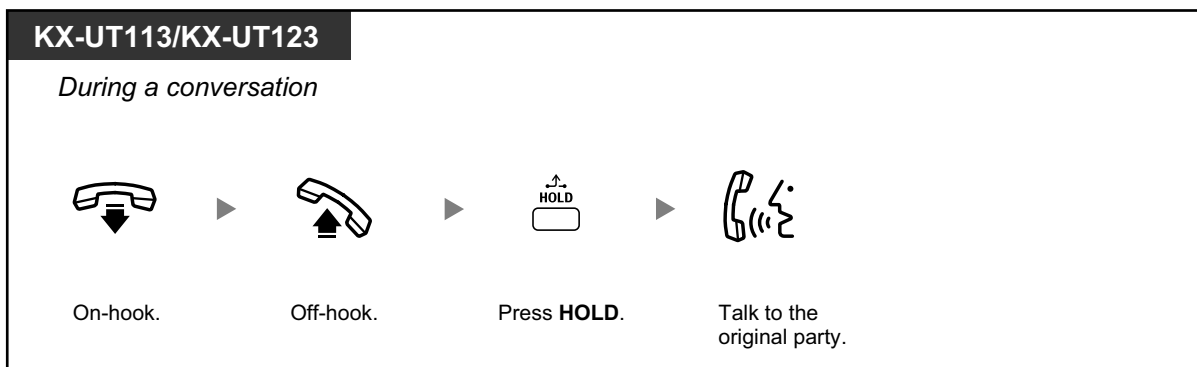
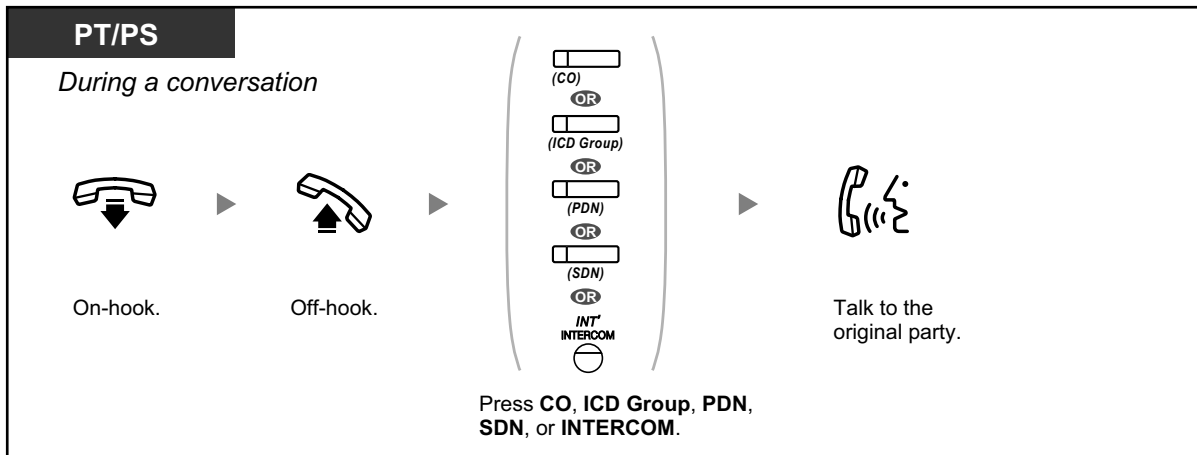

## 2.2 To hold the second call and then talk to the original party

After holding it, you can talk to the original party. Then, you can disconnect it and then talk to the new party again.

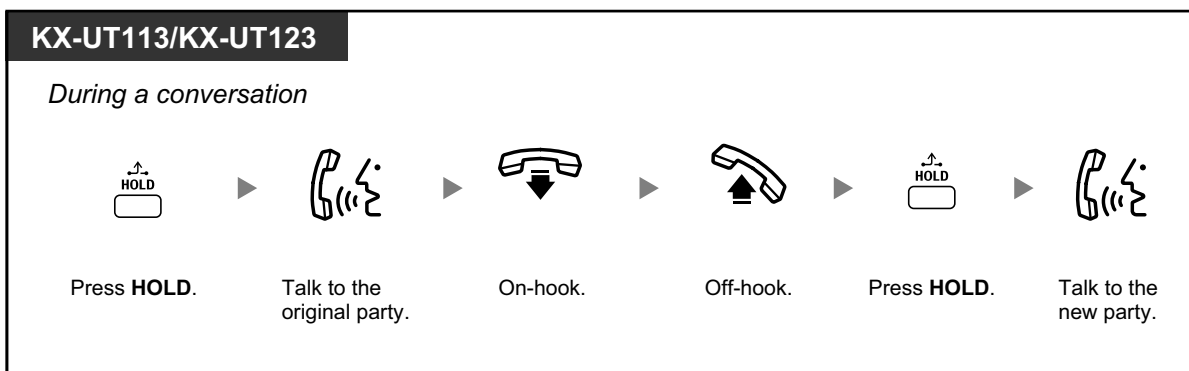
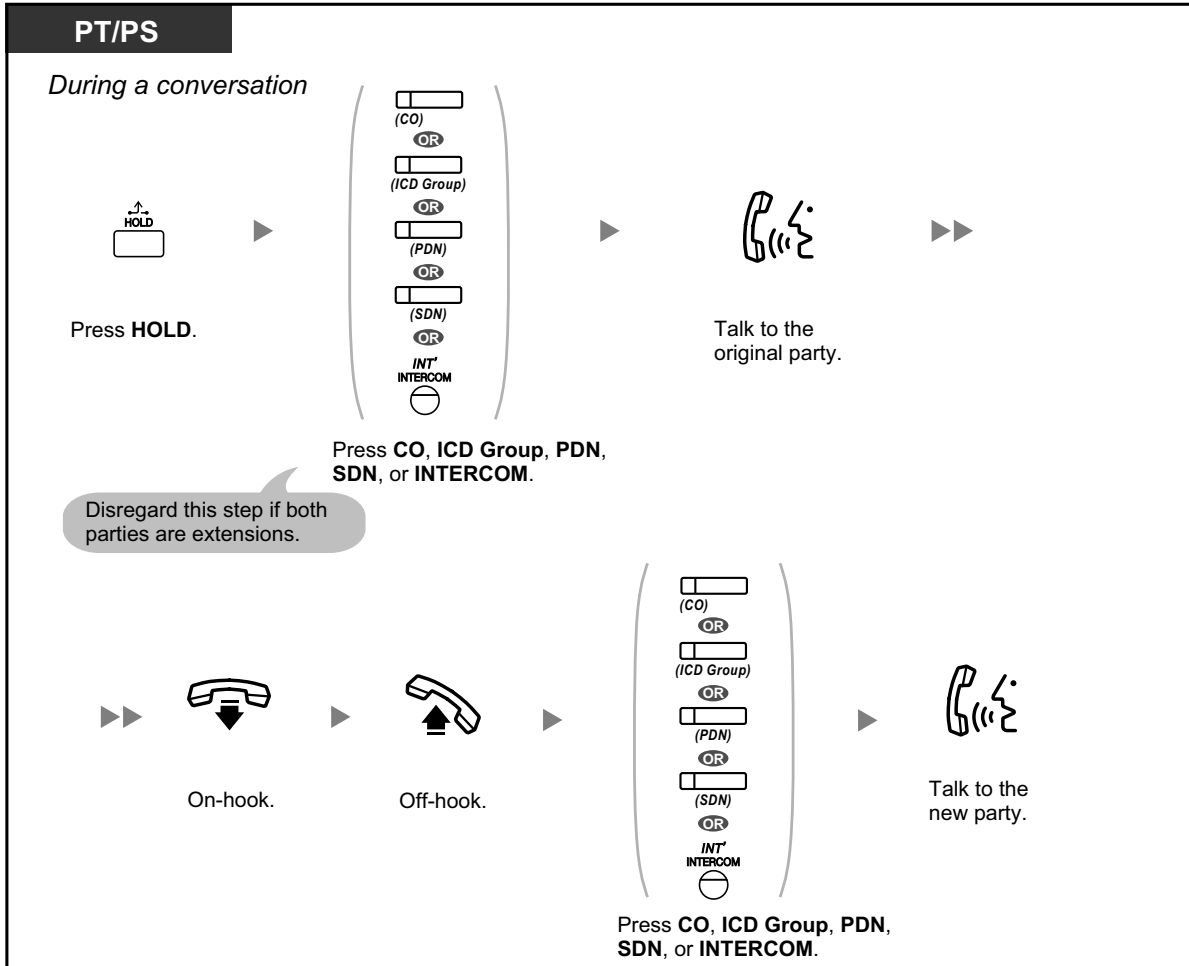



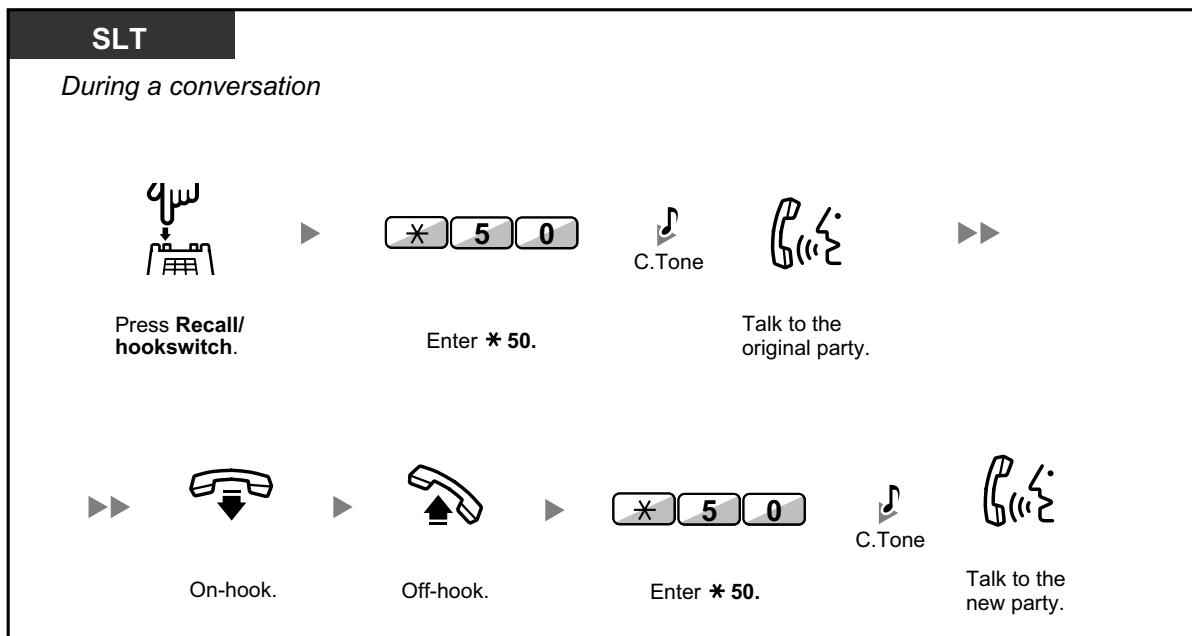
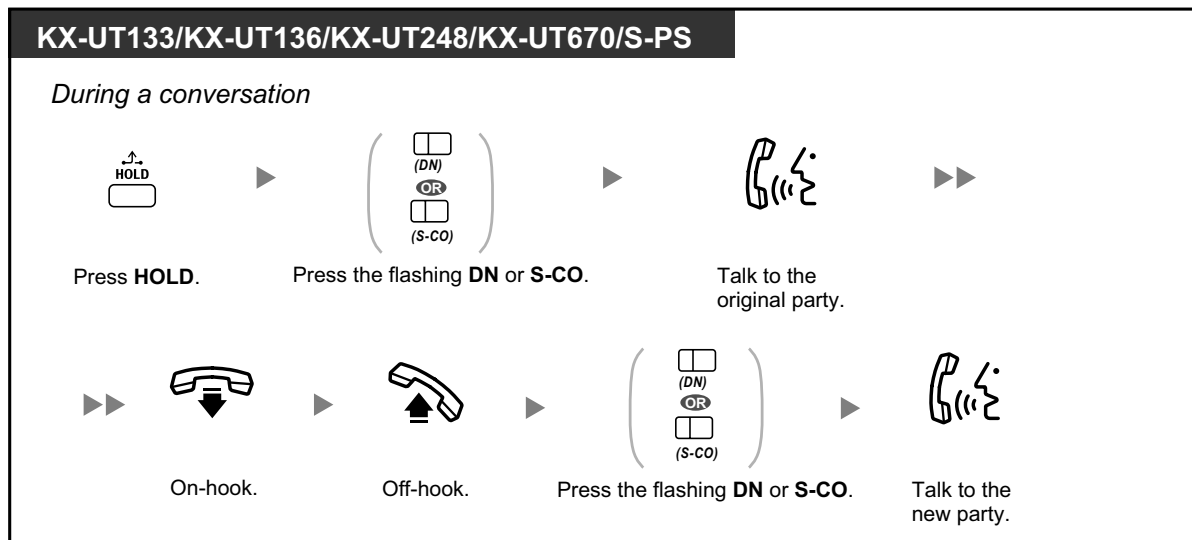

- **Depending on the type of your telephone**, you may be able to talk to the other party using the speaker and the microphone (Off-hook Call Announcement [OHCA]), or you can receive an announcement through the handset (Whisper OHCA) if you are having a conversation using the handset. Refer to "1.9.3 Receiving Call Waiting (Call Waiting/Off-hook Call Announcement [OHCA]/Whisper OHCA)".
- The caller's name or number is displayed for five seconds in fifteen second intervals while waiting to be answered.



### Customising Your Phone



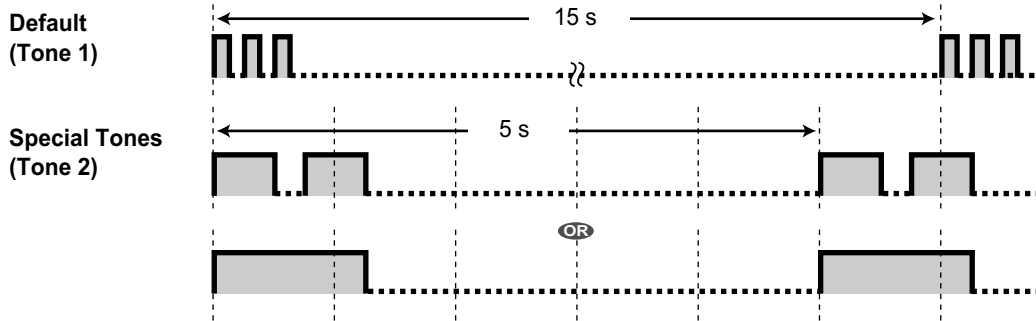

- 3.1.2 Settings on the Programming Mode—**Call Waiting Tone Type Selection**  
If you select "Tone 1", you will hear the same tone for Call Waiting from an outside party and an extension. If you select "Tone 2", you will hear different tones for Call Waiting from an outside party and an extension.



- Only tone 1 is available for KX-UT series SIP phones.

## ◆◆ Answering Call Waiting from the Telephone Company

This is an optional telephone company service. You can receive a call waiting tone and the caller's information. For details, consult your telephone company.

PT/PS/KX-UT series/S-PS	PT/SLT/PS
<p><i>While hearing a tone</i></p> <p>                       OR   </p> <p>Press <b>FLASH/RECALL</b> or <b>EFA</b>.</p>	<p><i>While hearing a tone</i></p> <p>                       OR   </p> <p>Press <b>TRANSFER</b> or <b>Recall/hookswitch</b>.</p> <p>Enter <b>*60</b>.</p>



- To return to the original party, repeat the operation.
- In this case, the FLASH/RECALL button on a proprietary telephone, KX-UT series SIP phone, or S-PS must be set to External Feature Access (EFA) mode through system programming.



### Customising Your Phone

- 3.1.3 Customising the Buttons  
Create or edit an External Feature Access (EFA) button.

## 1.4.5 Multiple Party Conversation

- ◆◆ Adding Other Parties during a Conversation (Conference)
- ◆◆ Leaving a Conference (Unattended Conference)
- ◆◆ Leaving a Conference (Leaving Three-party Conference)
- ◆◆ Letting a Third Party Join Your Call (Privacy Release)
- ◆◆ Adding a Third Party during a Conversation Using the ISDN Service (Three-party Conference [3PTY]—by ISDN)

### ◆◆ Adding Other Parties during a Conversation (Conference)

You can add one or more parties to your conversation.



- **For KX-UT133/KX-UT136/KX-UT248/KX-UT670 SIP phone and S-PS users:**  
When you press the CONFERENCE/CONF/Conference button for the first time to establish a conference call, the DN/S-CO button for the call will turn off and a new DN button will light green for the conference call. Even if you add more parties, only the newly lit DN button is lit up for the call.

#### To establish a conference call

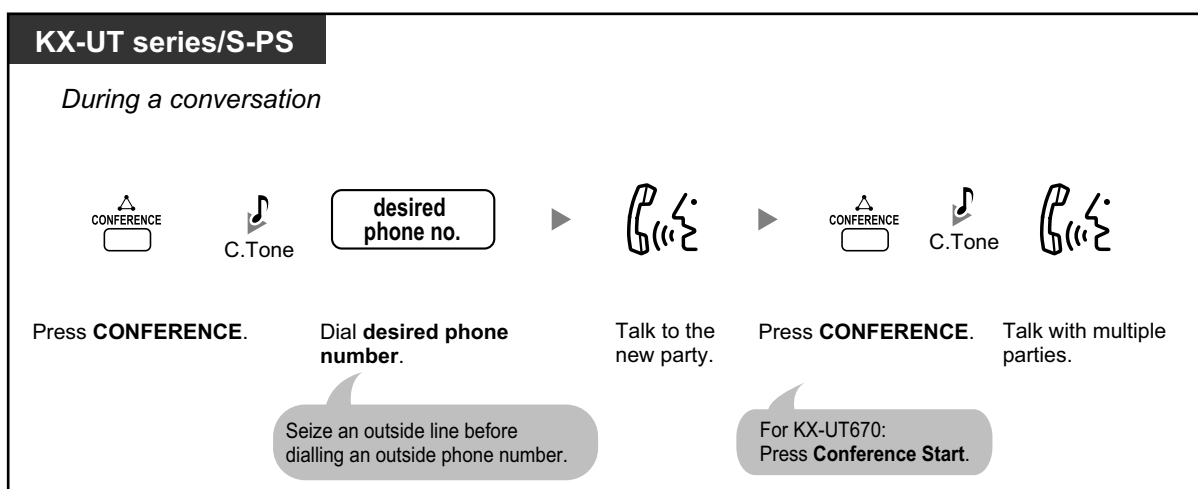
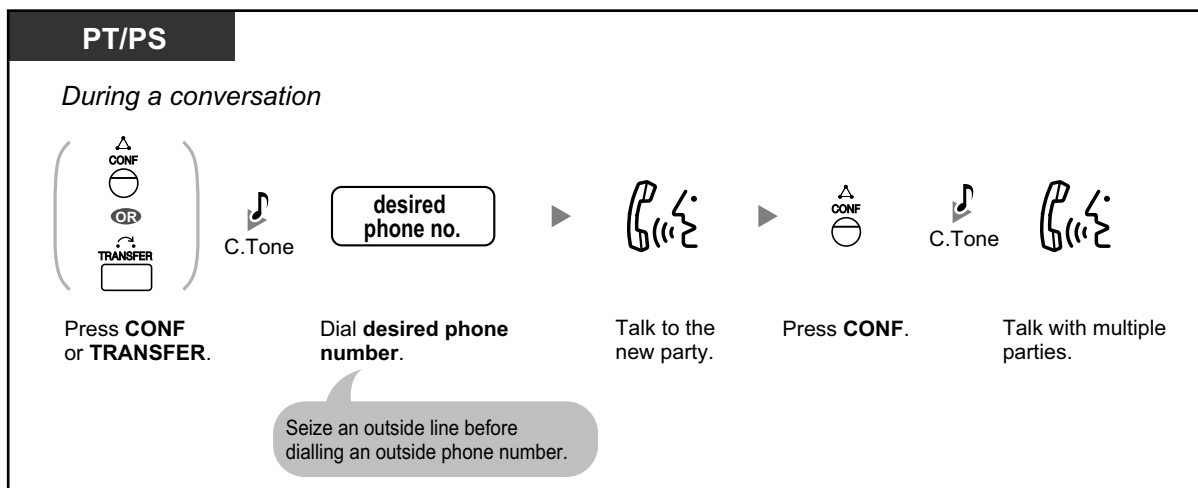

### 1.4.5 Multiple Party Conversation

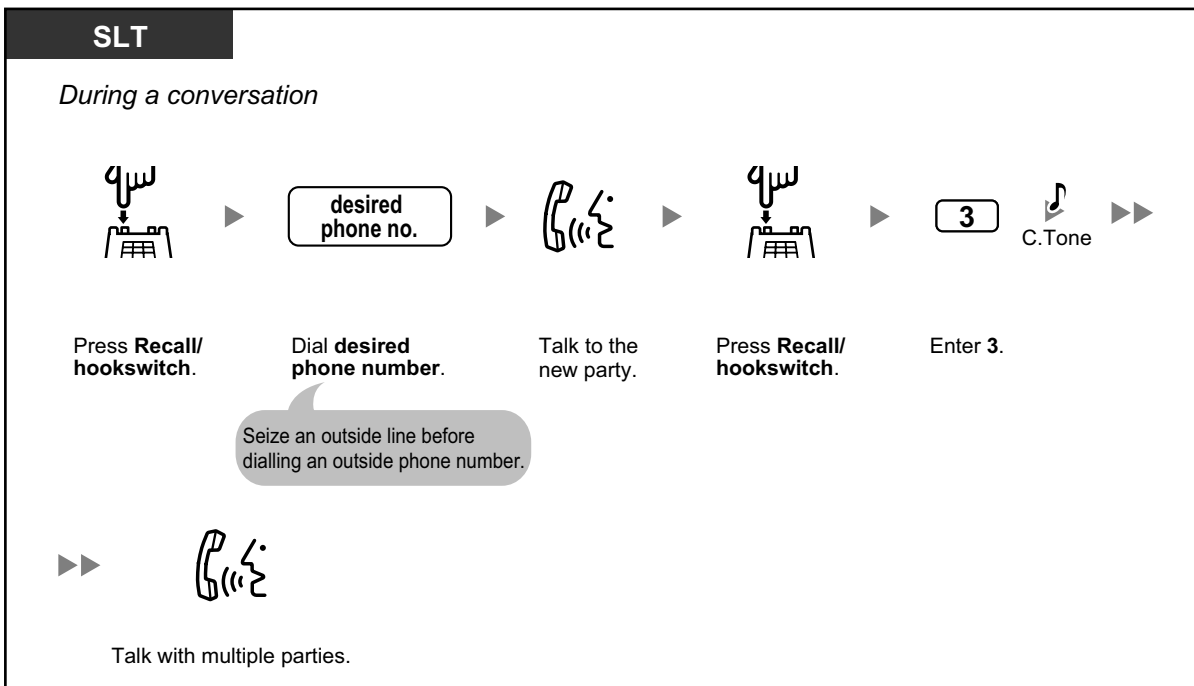
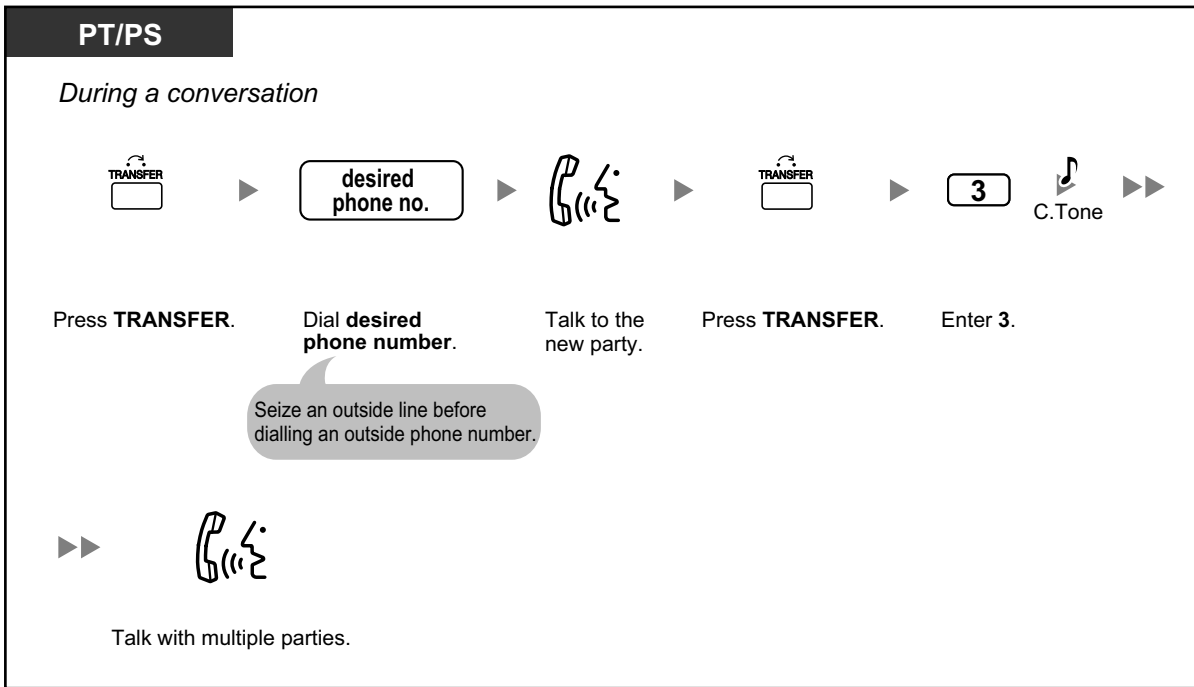

**To establish a conference call when receiving a call from an outside party during a two-party conversation**

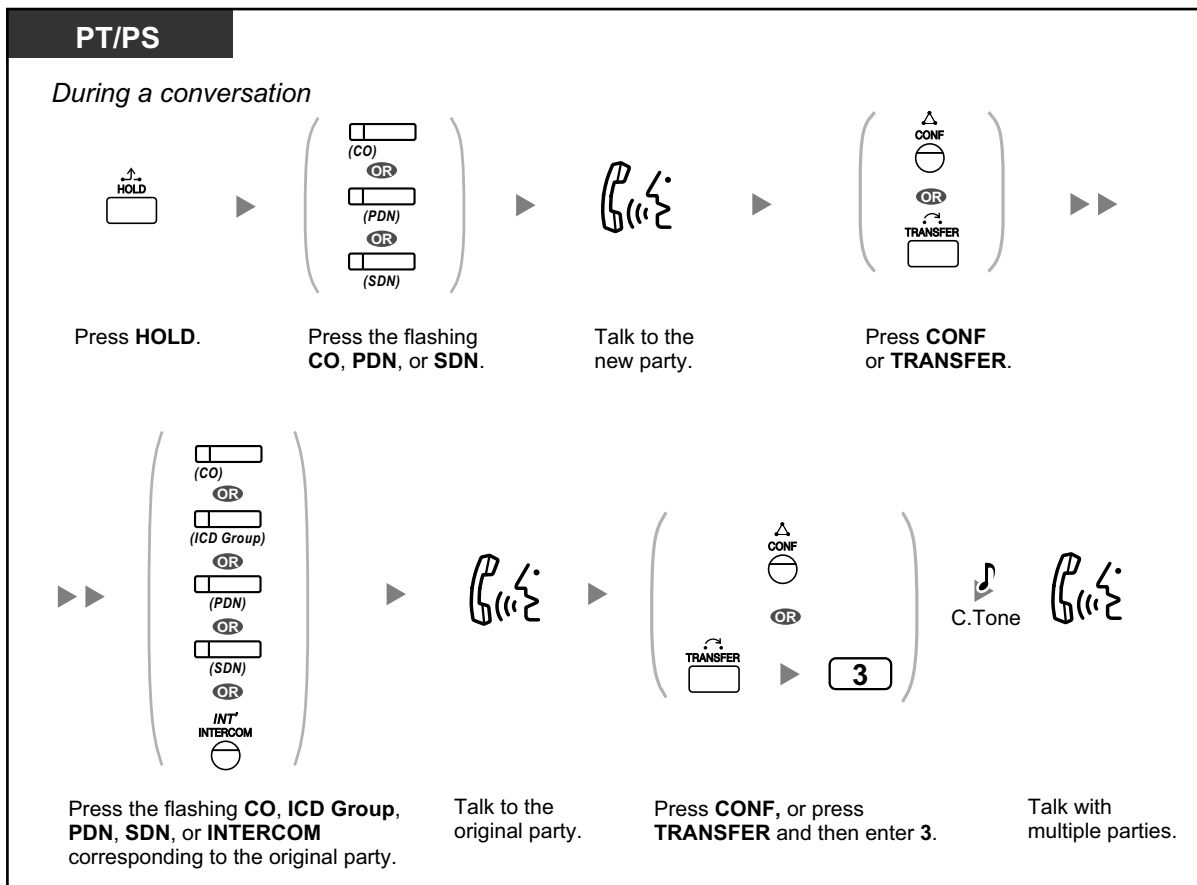

**To add four or more parties to a conference**

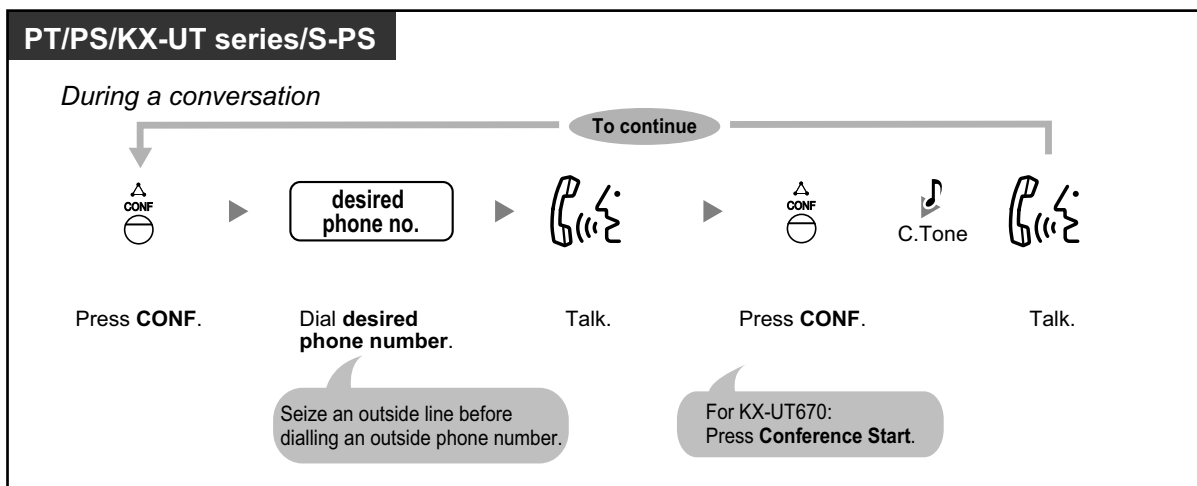

To add another party on hold to a conference

**PT/PS**

*During a 3- to 7-party conference*

Press **CONF**.

Press the flashing **CO**, **ICD Group**, **PDN**, or **SDN** corresponding to the party on hold.

Press **CONF**.

C.Tone

Talk with multiple parties.

To talk to two parties alternately in a three-party conversation

**PT/PS**

*During a conversation*

Press **TRANSFER**.

**SLT**

*During a conversation*

Press **Recall/hookswitch**.

## To disconnect one party and then talk to the other in a three-party conversation

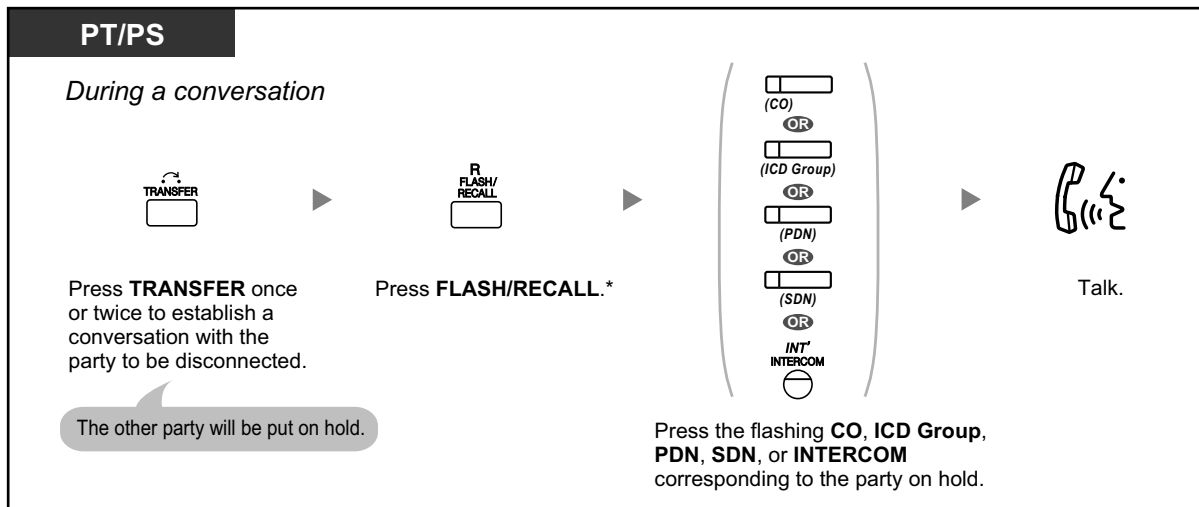

- \* In this case, the FLASH/RECALL button on a proprietary telephone must be set to Flash/Recall mode through system programming.
- During a three-party conversation, pressing the TRANSFER button or Recall/hookswitch alternates between the other parties in the conversation.
- You can have a conference with a maximum of eight parties (comprising intercom or outside lines) simultaneously.
- During a conversation involving four or more parties, you cannot disconnect one party and maintain the conversation with the other parties.
- Non-KX-UT series SIP phone users cannot originate a conference call, but can be added as a member.
- When a KX-UT series SIP phone or S-PS user originates a conference call and one of the other parties leaves the conference, the KX-UT series SIP phone or S-PS user will still be able to talk to the remaining party but will not be able to hold the call.



### Customising Your Phone

- 3.1.3 Customising the Buttons  
Create or edit a Conference button.

## ◆◆ Leaving a Conference (Unattended Conference)

The person who originated a conference can leave the conference, and allow the other parties to continue the conversation.



- KX-UT series SIP phone and S-PS users: If you originated a conference, you cannot leave the conference and allow the other parties to continue the conversation. When you go on-hook, the conference is terminated and the other parties are disconnected.

### To leave a conference

**PT/PS**









*During 3- to 7-party conference*

Press **CONF**.      On-hook.

### To return while others are talking

**PT/PS**

        

Press flashing green **CO**, **ICD Group**, **PDN**, **SDN**, or **INTERCOM**.

### To complete a conversation

**PT/PS**

*During a conversation*



On-hook.



- **Time limit**  
Both parties will hear an alarm tone before a specified timeout. The originating extension user will hear an alarm tone before timeout. The call is disconnected when the timer runs out unless the originating extension returns to the conference.





### **Customising Your Phone**

- 3.1.3 Customising the Buttons  
Create or edit a Conference button.

### ◆◆ Leaving a Conference (Leaving Three-party Conference)

The person who originated a conference with two other parties can leave the conference, and allow the other parties to continue the conversation.

#### To leave a conference involving at least one other extension

**PT/SLT/PS/KX-UT series/S-PS**

*During a three-party conference*



On-hook.

#### To leave a conference involving two outside parties

**PT/PS**

*During a three-party conference*



Press **TRANSFER**.      On-hook.

**SLT**

*During a three-party conference*



Press **Recall/hookswitch**.      On-hook.



- To leave a conference call involving two outside parties and have the conversation continue, your extension must be enabled to transfer calls to outside lines through COS programming.

## ◆◆ Letting a Third Party Join Your Call (Privacy Release)

You can let a third party join your current outside call and establish a three-party conversation. You can also leave the conversation and then let the two other parties talk.



To let a third party join your conversation and establish a three-party conversation

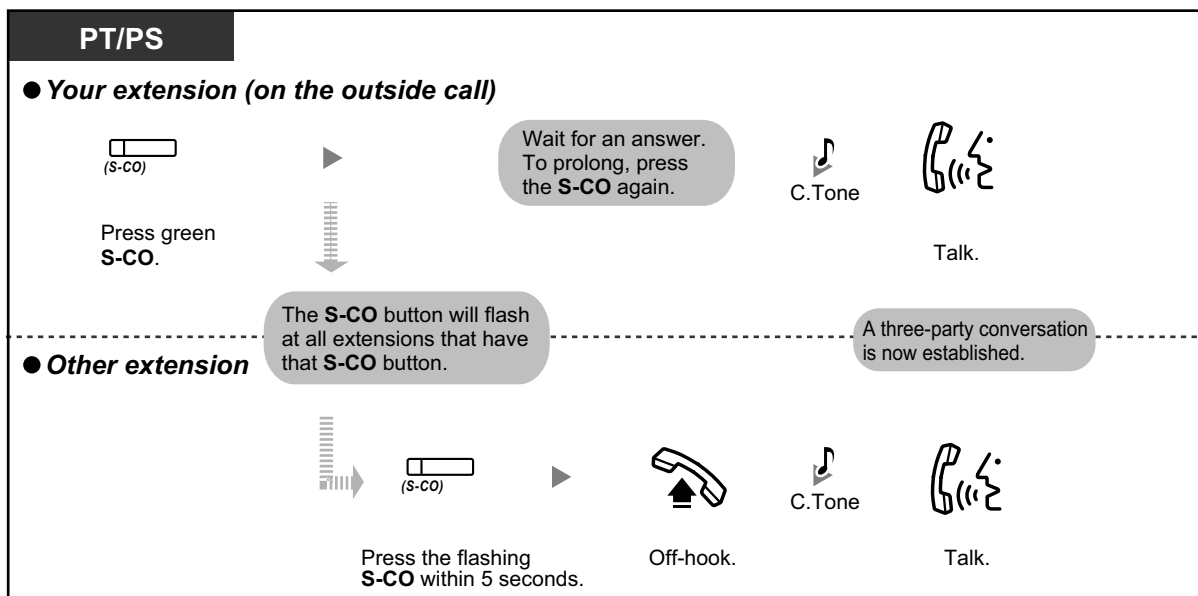

- Only an S-CO button can be used for this operation.
- You can leave a three-party conversation and let the two other parties talk by simply going on-hook.

## ◆◆ Adding a Third Party during a Conversation Using the ISDN Service (Three-party Conference [3PTY]—by ISDN)

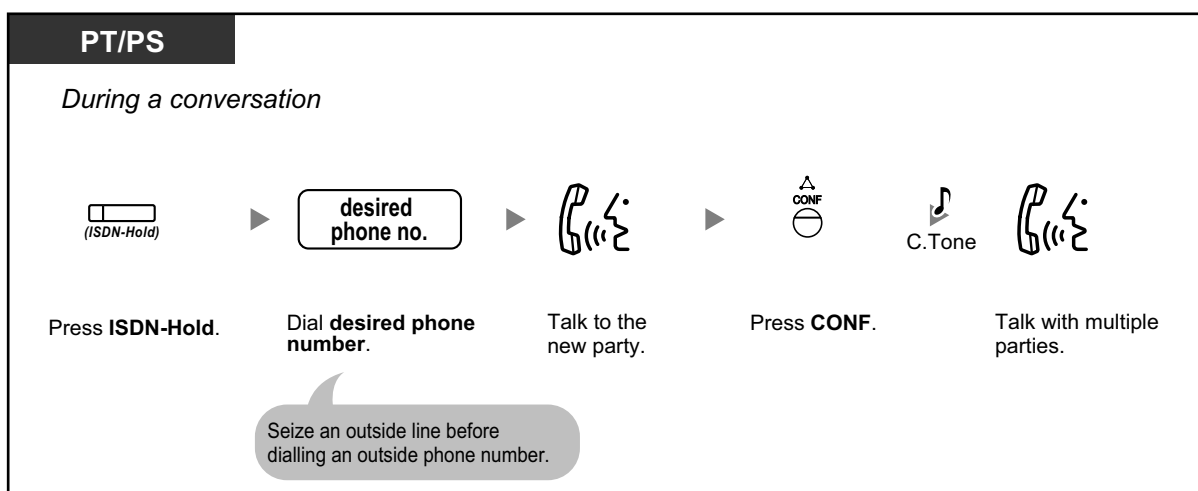

### 1.4.5 Multiple Party Conversation

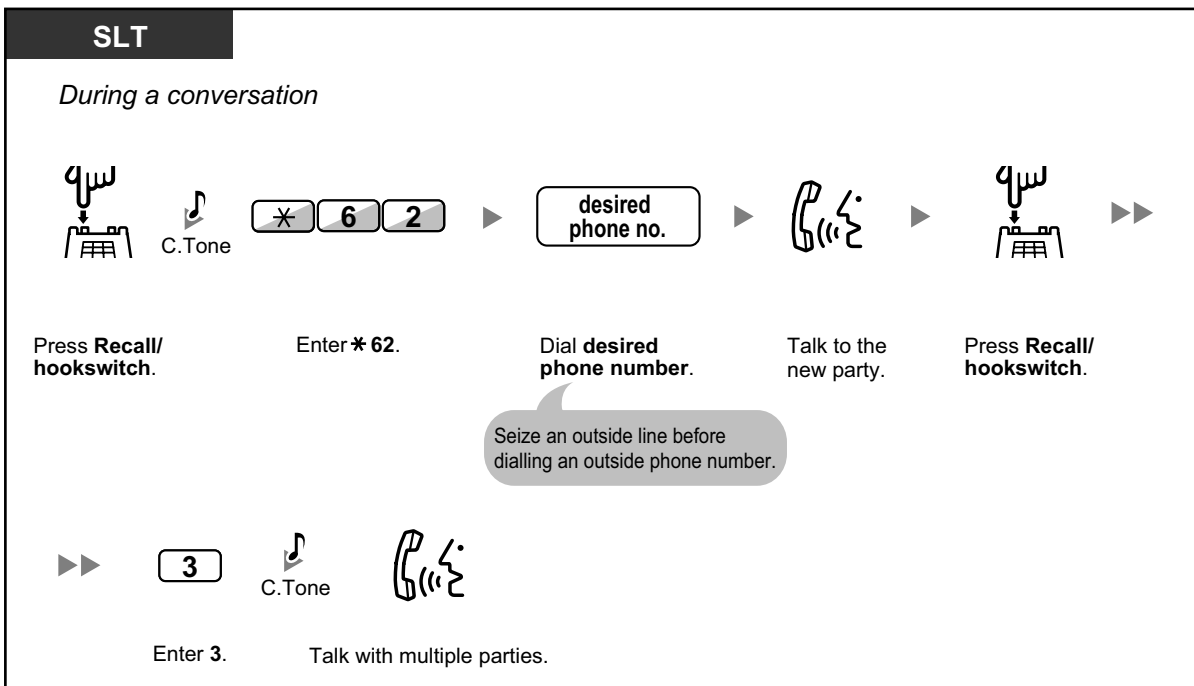
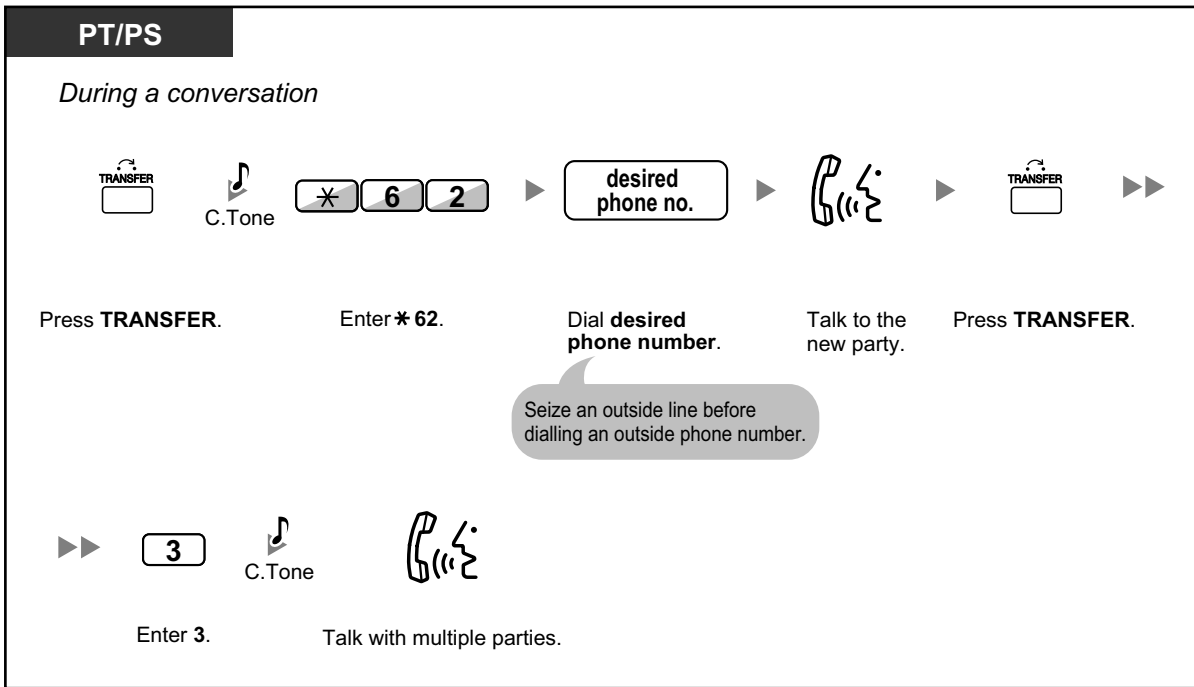

### To complete a conversation



### Customising Your Phone

- 3.1.3 Customising the Buttons  
Create or edit an ISDN-Hold button.

## 1.4.6 Mute





You can disable the microphone or the handset to consult privately with others in the room while listening to the other party on the phone through the speaker or the handset.





### To set/cancel

**PT/KX-UT series**

*During a conversation*

 **AUTO ANS**   **VOICE CALL**   **Mute**

**MUTE**  **MUTE**  **MUTE**

Press **MUTE**.



- The AUTO ANS/MUTE or VOICE CALL/MUTE button light for PTs, or the SP-PHONE button light for KX-UT series SIP phones shows the current status as follows:  
**Off:** Normal  
**Flashing red:** Mute
- If mute is used during OHCA, it will become Handset Mute.
- PS and S-PS users: Refer to the documentation for your phone.

## 1.4.7 Letting Other People Listen to the Conversation (Off-hook Monitor)

You can let other people in the room listen to the conversation through the speaker while continuing the conversation using the handset.



### To set/cancel

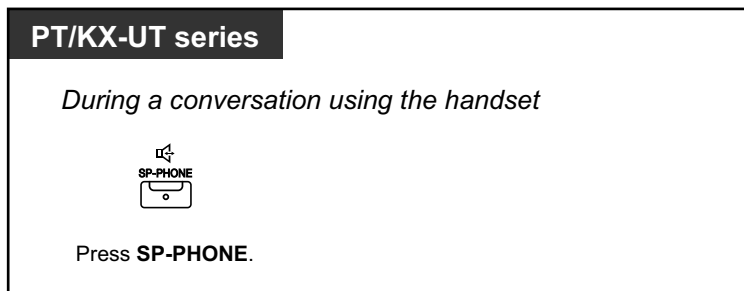

- The SP-PHONE button light shows the current status as follows:
  - Off:** The voice is heard through the handset.
  - On:** The voice is heard through the speaker and the handset.
- This feature requires system programming.



- Hands-free operation**  
You can have a conversation in hands-free mode using the SP-PHONE button. You can perform other tasks simultaneously.
- Helpful hints for hands-free operation:**
  - If it is difficult to hear the other party's voice,**  
Increase the volume using the Navigator Key, Jog Dial, or Volume Key.
  - If the other party has difficulty hearing you,**  
Decrease the volume.
  - If the other party reports that your voice echoes,**  
Use the telephone in a room that has curtains, carpeting or both.
  - If parts of the conversation cannot be heard,**  
If you and the other party speak at the same time, parts of your conversation may be lost. To avoid this, try to speak alternately.

## 1.4.8 Using the Headset (Headset Operation)

You can have a conversation using a headset.

In this case, you must select "Headset on" in programming mode or set the Headset button on (red) in advance. However, for the KX-UT113/KX-UT123 and S-PS, Headset mode is enabled automatically when a headset is connected to the headset jack of the telephone. This feature is also known as Handset/Headset Selection.



### To talk using the headset

**PT/KX-UT series**



Press **SP-PHONE**.

### To use the handset during a conversation using the headset

**PT/KX-UT series**



Off-hook.

### To talk in hands-free mode during a conversation using the headset

**PT/KX-UT133/KX-UT136/KX-UT248/KX-UT670**



Press red **Headset**.



- The Headset button light shows the current status as follows:  
**Off:** Headset mode off  
**Red on:** Headset mode on
- This feature is not available for the KX-T7665 or KX-NT511.





- **For KX-NT300 series (except KX-NT321)/KX-NT560/KX-DT343/KX-DT346/KX-UT248 telephone users:**
  - With KX-NT300 series (except KX-NT321)/KX-NT560/KX-DT343/KX-DT346/KX-UT248 telephones, you can use a Bluetooth wireless headset registered on your extension as a headset.
  - **Operating Distance**  
Please keep the telephones with connected Bluetooth Modules, 3 m or more apart from each other. Also, if a Bluetooth headset is in use near a telephone with a connected Bluetooth Module, other than the one it is registered to, noise may be heard. Move away from the telephone and closer to the one it is registered to, to improve the signal.
  - **Noise**  
Signals are transmitted between this module and the Bluetooth headset using radio waves. For maximum distance and noise free operation, it is recommended that the module is situated away from electrical appliances such as faxes, radios, PCs, or microwaves.
    - Systems using the 2.4 GHz ISM (Industrial, Scientific and Medical) band may interfere with this product. Examples of such systems are cordless telephones, wireless LAN, Home RF, microwave ovens and other ISM devices. These systems may cause minor noise.
- **For KX-UT248, KX-NT560, and Bluetooth-compatible S-PS telephone users:**
  - You may not be able to use all of the functionality available on a Bluetooth headset. For example, redialling will not work with a REDIAL button on a Bluetooth headset, and, during hands-free mode, you cannot switch the call to the Bluetooth headset through headset operation.
- **For KX-NT500 series (except KX-NT511/KX-NT551), KX-DT543, KX-DT546, KX-UT133, KX-UT136, KX-UT248, and KX-UT670 telephone users:**
  - You can use Electric Hook Switch (EHS) headsets. For the latest information about headsets that have been tested with this unit, consult your dealer.



### Customising Your Phone

- 3.1.2 Settings on the Programming Mode—**Headset Operation**  
Select the equipment to use.
- 3.1.3 Customising the Buttons  
Create or edit a Headset button.

## 1.5 Using a PDN/SDN Button

### 1.5.1 Primary Directory Number (PDN)/Secondary Directory Number (SDN) Extension

Primary Directory Number (PDN) buttons and Secondary Directory Number (SDN) buttons are useful when extension users will handle calls for other extensions. For example, a secretary or multiple secretaries can handle calls and check the call status of a boss or multiple bosses. The functions of PDN and SDN buttons are as follows:



**PDN button:** This button can be used to make and receive all calls (including both outside and intercom calls). Having multiple PDN buttons allows multiple calls to be queued at the extension. Extensions that have a PDN button are called PDN extensions.

**SDN button:** The light of an SDN button displays the current call status of the registered extension, similar to a DSS button. In addition, this button can be used to perform the following operations:

- call the PDN extension (◆◆ SDN Direct Dial)
- answer calls ringing at the PDN extension
- hold calls and retrieve calls held by the PDN extension (◆◆ Call Hold and Call Hold Retrieve)
- transfer calls to the PDN extension (◆◆ Call Transfer Using SDN Button)

Extensions that have an SDN button are called SDN extensions.



- The extension that is registered as the destination of an SDN button must have at least one PDN button.
- One extension can have up to 8 PDN buttons.
- An extension can have only one SDN button for each PDN extension.
- The button light of each PDN/SDN button shows the current status as follows:

Light Pattern	PDN Button Status	SDN Button Status
<b>Off</b>	The PDN extension is idle.	
<b>Green on</b>	The extension is on a call using the PDN button.	The extension is on a call using an SDN button.
<b>Flashing green slowly</b>	A call is on hold at the PDN extension (Regular Hold).	A call answered with the SDN button is on hold (Regular Hold).
<b>Flashing green moderately</b>	A call is on hold temporarily or on Exclusive Call Hold.	A call answered with the SDN button is on hold temporarily or on Exclusive Call Hold.
<b>Flashing green rapidly</b>	The PDN extension is receiving an incoming call.	An SDN extension is receiving a Hold Recall or callback ringing from a call answered with the SDN button.
<b>Red on</b>	A corresponding SDN extension is using the line.	The corresponding PDN extension or another corresponding SDN extension is using the line.
<b>Flashing red slowly</b>	A corresponding SDN extension is holding a call.	Another corresponding SDN extension, or the PDN extension itself, is holding a call.

Light Pattern	PDN Button Status	SDN Button Status
Flashing red rapidly	The PDN extension is receiving an incoming call to an incoming call distribution (ICD) group.	The corresponding PDN extension is receiving an incoming call.

## ◆◆ SDN Direct Dial

Using an SDN button, you can easily call the corresponding PDN extension. SDN buttons are in one of two modes depending on system programming, and the operation procedure differs as follows:

### Enhanced DSS Key Mode



### Standard SDN Key Mode

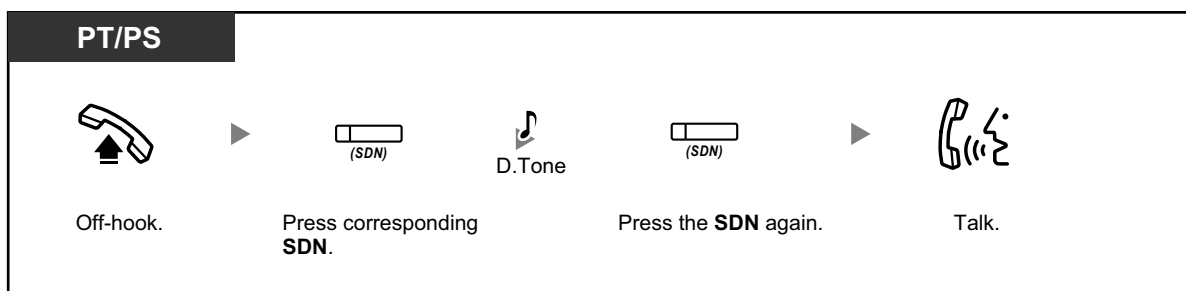

- When performing SDN Direct Dial to call the corresponding PDN extension, the SDN button light shows the current status of the destination extension as follows:  
**Green on:** You are using the line.  
**Red on:** The line is being used. (The PDN extension, or another SDN extension when multiple extensions have SDN buttons to a same PDN extension, is using the line.)
- Even if a PDN extension has set Do Not Disturb (DND), you can call the extension as normal by pressing the SDN button.



- When an SDN button is in Standard SDN Key Mode, you can dial a telephone number while hearing a dial tone, instead of pressing the SDN button again. Depending on system programming, your call will be made using either your normal calling privileges (Class of Service) or those of the corresponding PDN extension (**SDN Walking COS**).

## ◆◆ Call Hold and Call Hold Retrieve

You can put calls answered with a PDN or SDN button on hold normally (→1.4.2 **Holding a Call**). You can also retrieve a call held at your extension/another extension with a simple operation, regardless of the call type.

### Call Hold Retrieve

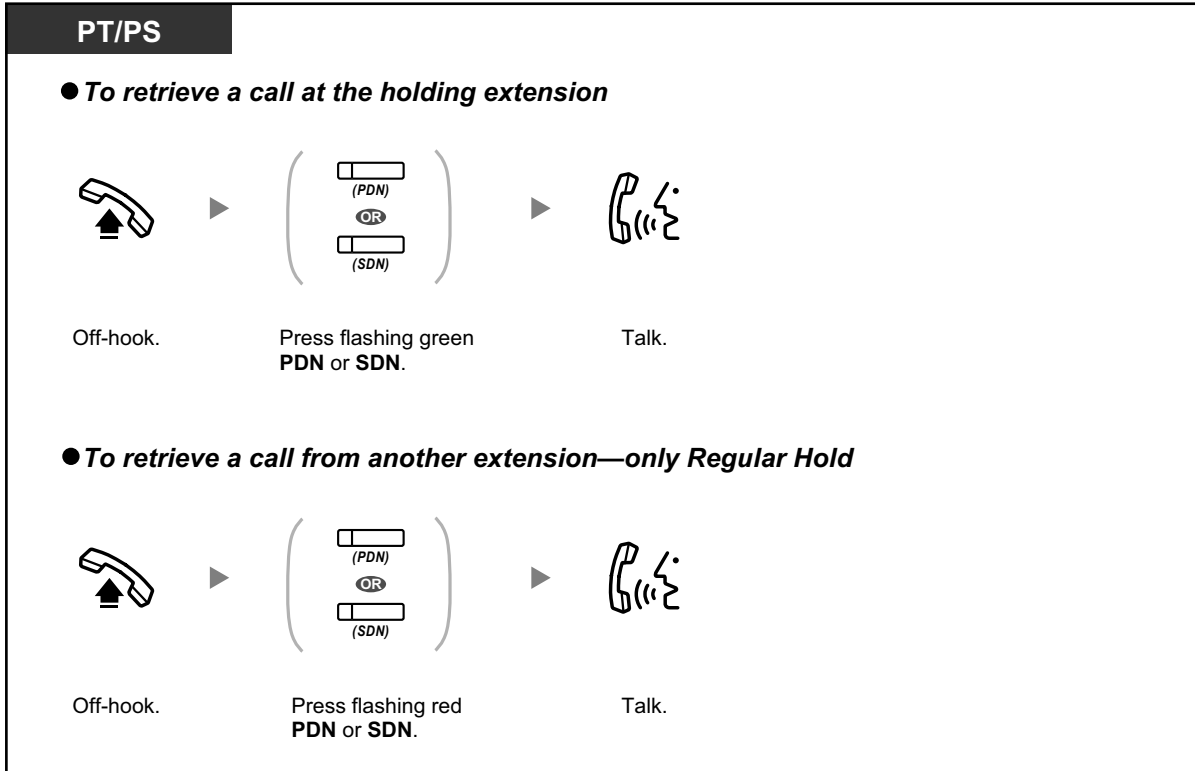

- **If a call is not retrieved within a specified time**, you will hear an alarm as a reminder (Hold Recall).  
If an outside call is not answered within a specified time, it is automatically disconnected.



- If **Automatic Call Hold** has been preprogrammed, you can put the current call on hold automatically by pressing another PDN button to make or answer another call.

## ◆◆ Call Transfer Using SDN Button

You can transfer a call to a PDN extension with a simple operation using a corresponding SDN button.

### To transfer a call to a PDN extension

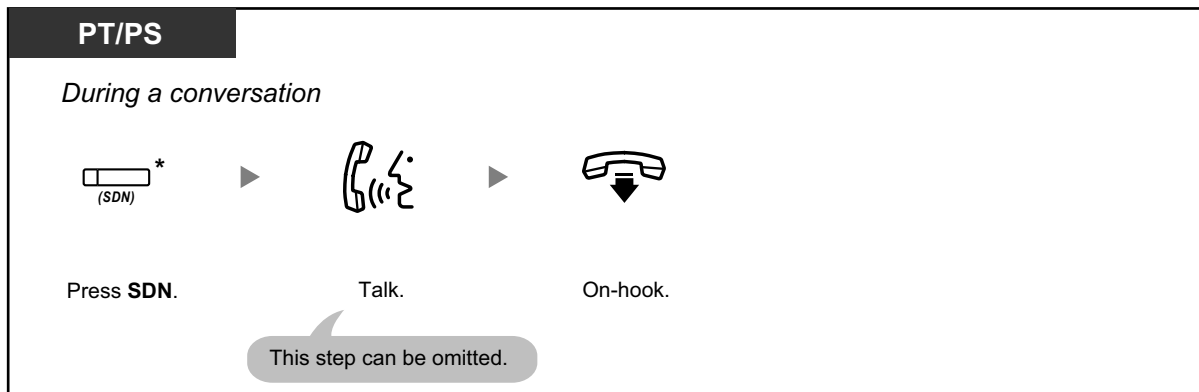

- System programming is required to use this feature during a conversation with an extension.
- \* When an SDN button is in Standard SDN Key Mode, you have to press the SDN button twice to transfer the call, unless you used that SDN button to answer an incoming call.



### Customising Your Phone

- 3.1.2 Settings on the Programming Mode—**Preferred Line Assignment—Incoming**  
Select the seized line when going off-hook.
- 3.1.2 Settings on the Programming Mode—**Preferred Line Assignment—Outgoing**  
Select the seized line when going off-hook.
- 3.1.3 Customising the Buttons  
Create or edit a Primary Directory Number (PDN) or Secondary Directory Number (SDN) button.

# 1.6 Before Leaving Your Desk

## 1.6.1 Forwarding Calls

- ◆◆ Forwarding Your Calls (Call Forwarding [FWD])
- ◆◆ FWD/DND Settings Using Fixed FWD/DND Button
- ◆◆ Forwarding Your Calls Using ISDN Service (Call Forwarding [CF]—by ISDN)

### ◆◆ Forwarding Your Calls (Call Forwarding [FWD])

You can have your incoming calls forwarded to a specified destination.

**All Calls:**

All calls are forwarded. Preset extensions may also forward from their own receiving group.

**Busy:**

All calls are forwarded when your extension is busy.

**No Answer:**

All calls are forwarded when you do not answer the call within a specified time period.

**Busy/No Answer (BSY/NA):**

All calls are forwarded when you do not answer within a specified time period or when your extension is busy.

**Follow Me (From):**

If you fail to set the above-mentioned "All Calls" to forward before you leave your desk, you can set the same feature from the destination extension.

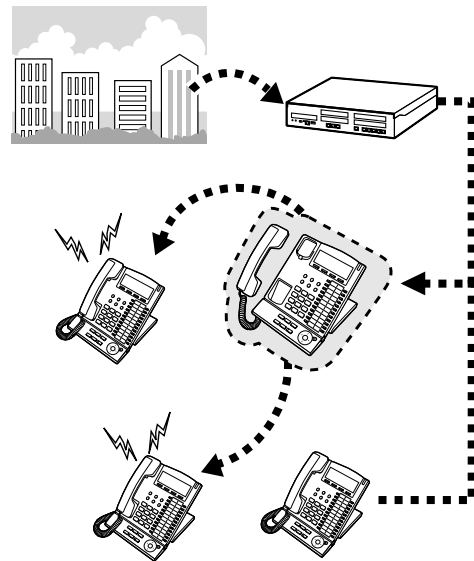

- Incoming calls can be forwarded up to four times.



- You can set the UM group's floating extension number as a forward destination.
- You can set the floating extension number of a voice mail group or the SVM feature as a forward destination.
- You can set your cellular phone as the forward destination.
- **Boss & Secretary feature**  
The extension which has been set as the destination can call the forwarding extension.

<Example>

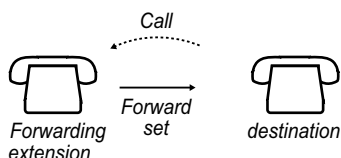

To set/cancel

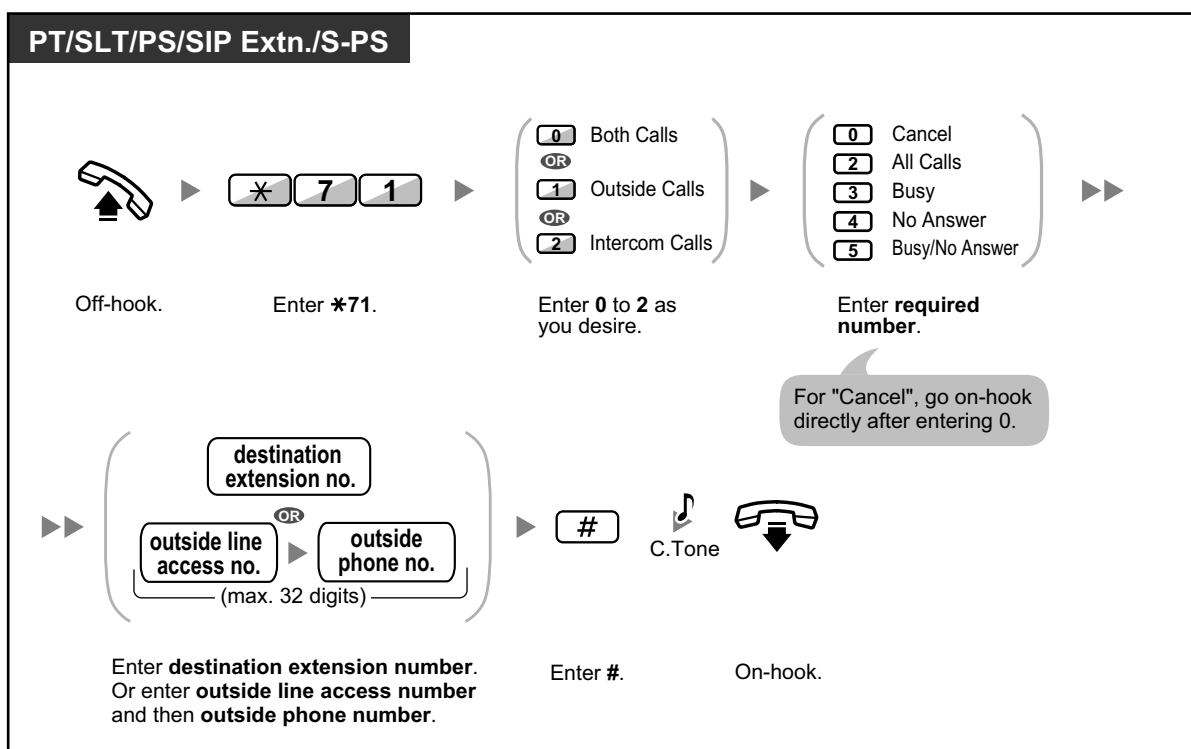

**To set Follow Me from another extension**

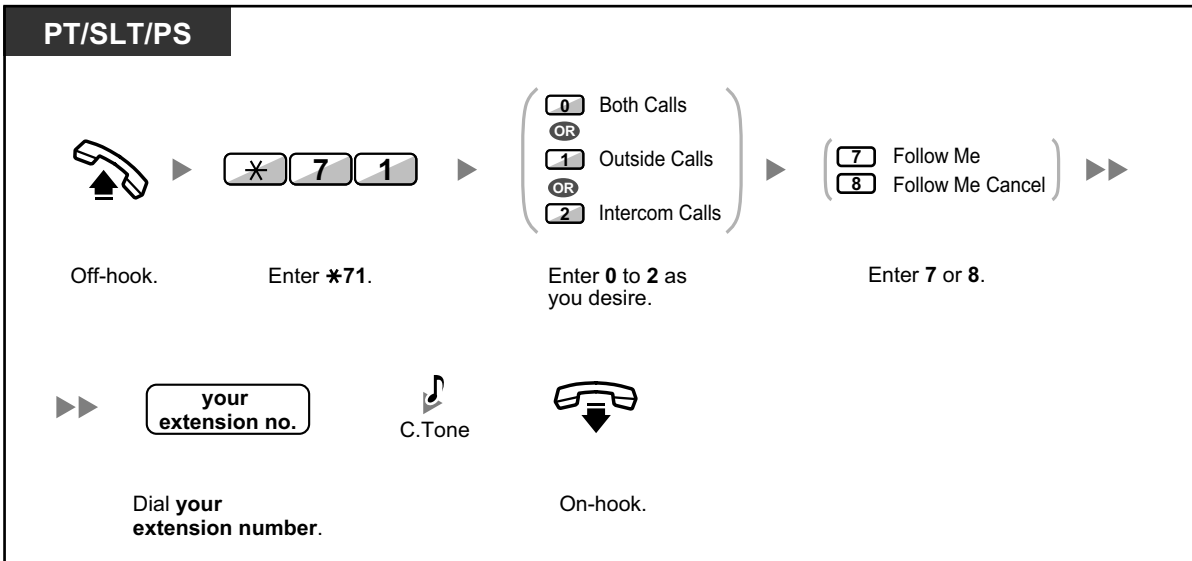

- It is not possible to set Follow Me from a SIP extension. However, it is possible to set it on a SIP extension from another extension that is not a SIP extension.



- When using a proprietary telephone, you can set or cancel Call Forwarding by pressing the FWD/DND button (fixed button) instead of "\*710". When using a KX-UT series SIP phone (except KX-UT670), you can also press the FWD/DND button and then press up or down with the Navigator Key to set or cancel Call Forwarding for all calls. For KX-UT670, there is no physical FWD/DND button on the phone. For details, refer to the documentation for your phone.

**To set the timer for "No Answer" and "Busy/No Answer"**

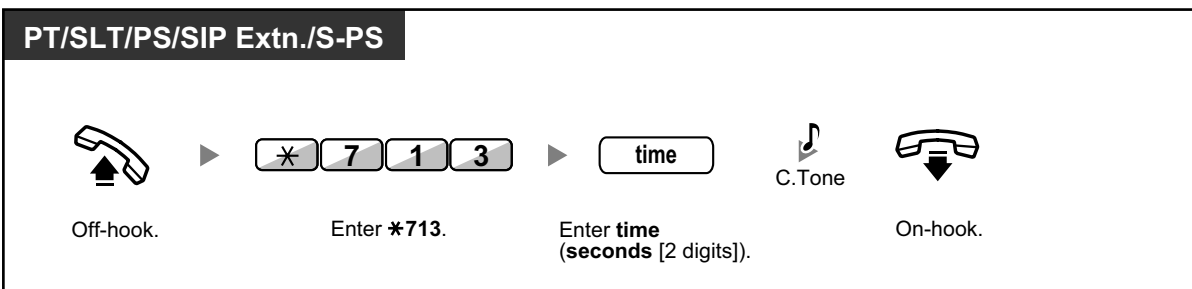



## To set/cancel (Call Forwarding [FWD] for your Incoming Call Distribution Group)

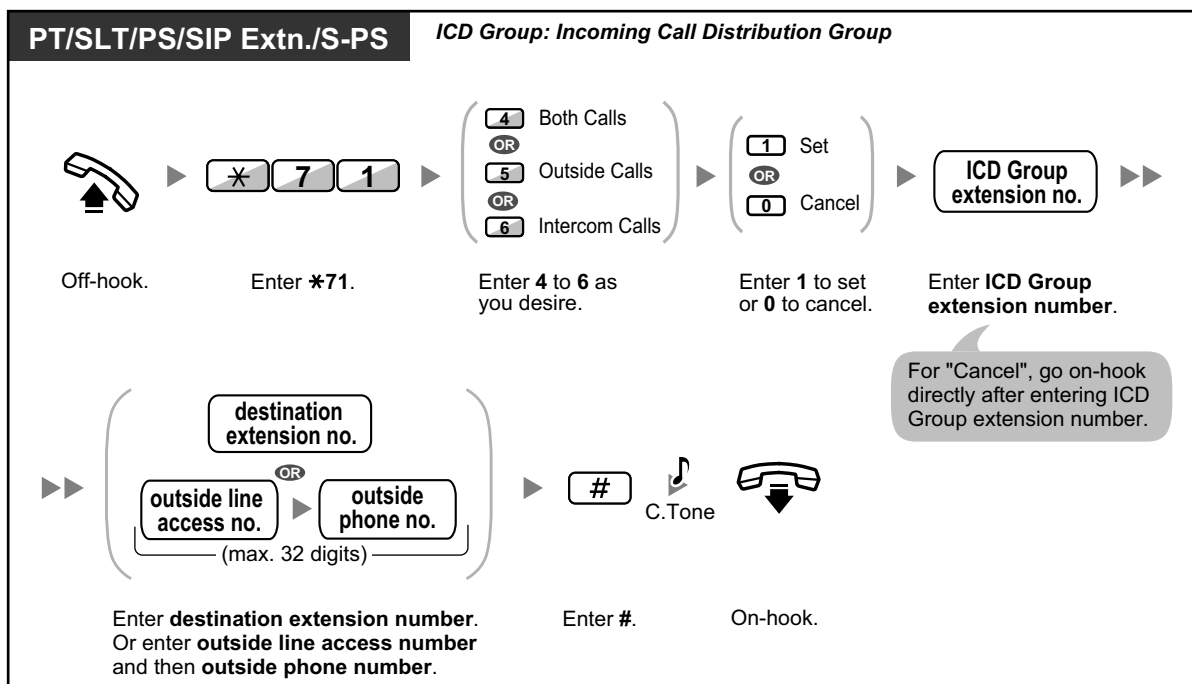

- For KX-UT series SIP phones (except KX-UT670), when Call Forwarding or Do Not Disturb is enabled, FWD/DND appears on the display in stand-by mode. For KX-UT670, when Call Forwarding or Do Not Disturb is enabled, a status icon appears on the display. For details, refer to the documentation for your phone.
- The FWD/DND button light shows the current status as follows:
  - Off:** Both features are not set.
  - Red on:** FWD mode
  - Flashing red slowly:** DND mode
 For KX-UT series SIP phones, you can see the current status on the display.
- The Group FWD button light shows the current status as follows:
  - Off:** No set
  - Red on:** FWD mode

## 1.6.1 Forwarding Calls

---

- The system has two modes: (1) FWD/DND Cycle Switch Mode and (2) FWD/DND Setting Mode. Ask your manager what mode your system is in if you are not sure. For KX-UT series SIP phones, only FWD/DND Setting Mode is supported.

### (1) When in FWD/DND Cycle Switch Mode:

Pressing the FWD/DND button (fixed button) while in idle status will cycle the setting as shown below:



### (2) When in FWD/DND Setting Mode:

Pressing the FWD/DND button (fixed button) while in idle status allows you to switch the FWD/DND status and set the FWD destination (refer to "◆◆ FWD/DND Settings Using Fixed FWD/DND Button").

#### **Note**

A FWD/DND button (customised button) is always in FWD/DND Cycle Switch Mode: the mode cannot be changed.

- Transferred outside calls are also forwarded to the destination assigned for outside calls.
- When intercom calls are set to be handled differently from outside calls (forwarding type, forward destination), we recommend establishing buttons for both FWD/DND—Outside calls and FWD/DND—Intercom calls, and/or Group FWD—Outside calls and Group FWD—Intercom calls, because:
  - a. the light patterns of the FWD/DND—Both calls button (including FWD/DND button [fixed button]) and the Group FWD—Both calls button will indicate the setting for either outside calls or intercom calls, but not both.

#### **Note**

The FWD icon on PS display reflects the setting for outside calls only.

- b. pressing the FWD/DND—Both calls button (including FWD/DND button [fixed button]) or the Group FWD—Both calls button will not change the FWD or DND mode for intercom calls and outside calls separately.



### Customising Your Phone

- 3.1.3 Customising the Buttons  
Create or edit FWD/DND (Both calls, Outside calls, Intercom calls) buttons, or Group FWD (Both calls, Outside calls, Intercom calls) buttons.

## ◆◆ FWD/DND Settings Using Fixed FWD/DND Button

Using a proprietary telephone (PT) or KX-UT series SIP phone (except KX-UT670), you can easily switch the FWD/DND status, and set the forward destination for outside/intercom calls with the FWD/DND button (fixed button). For PT users, it is also possible to set outside telephone numbers (e.g., your cellular phone) as forward destinations for up to 4 Virtual PSs\* in an Incoming Call Distribution (ICD) Group, to ring together with other ICD Group members for calls to the group.

The following settings are available:



- Switching the FWD/DND status and setting FWD destination for outside/intercom calls

- Timer for "No Answer" and "Busy/No Answer"
- Forwarding status (on/off) and outside destinations to ring in parallel for outside calls for up to 4 virtual PSs in an ICD Group

**\* Virtual PS**

A virtual PS is a dedicated extension number assigned to a non-existent portable station (PS) to allow access to outside destinations such as a cellular phone.

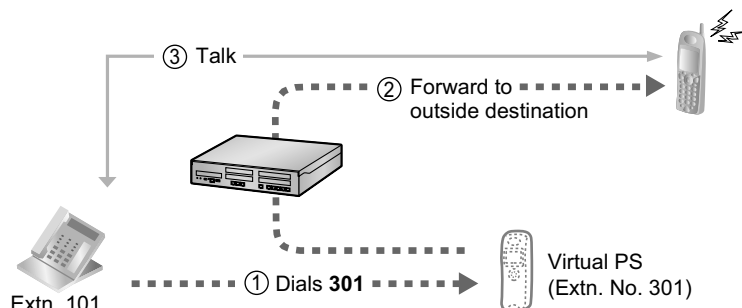

- For KX-UT670 SIP phone users: There is no physical FWD/DND button on the phone. To set and clear the FWD/DND status, refer to the documentation for your phone.

**To switch FWD/DND status for outside calls**

**PT**

*While on-hook (when in FWD/DND Setting Mode)*

**To switch FWD/DND status for intercom calls**

**PT**

*While on-hook (when in FWD/DND Setting Mode)*



- When you switch the FWD/DND status, any FWD destination that was set previously is not cleared.

To set and clear FWD/DND for outside/intercom calls

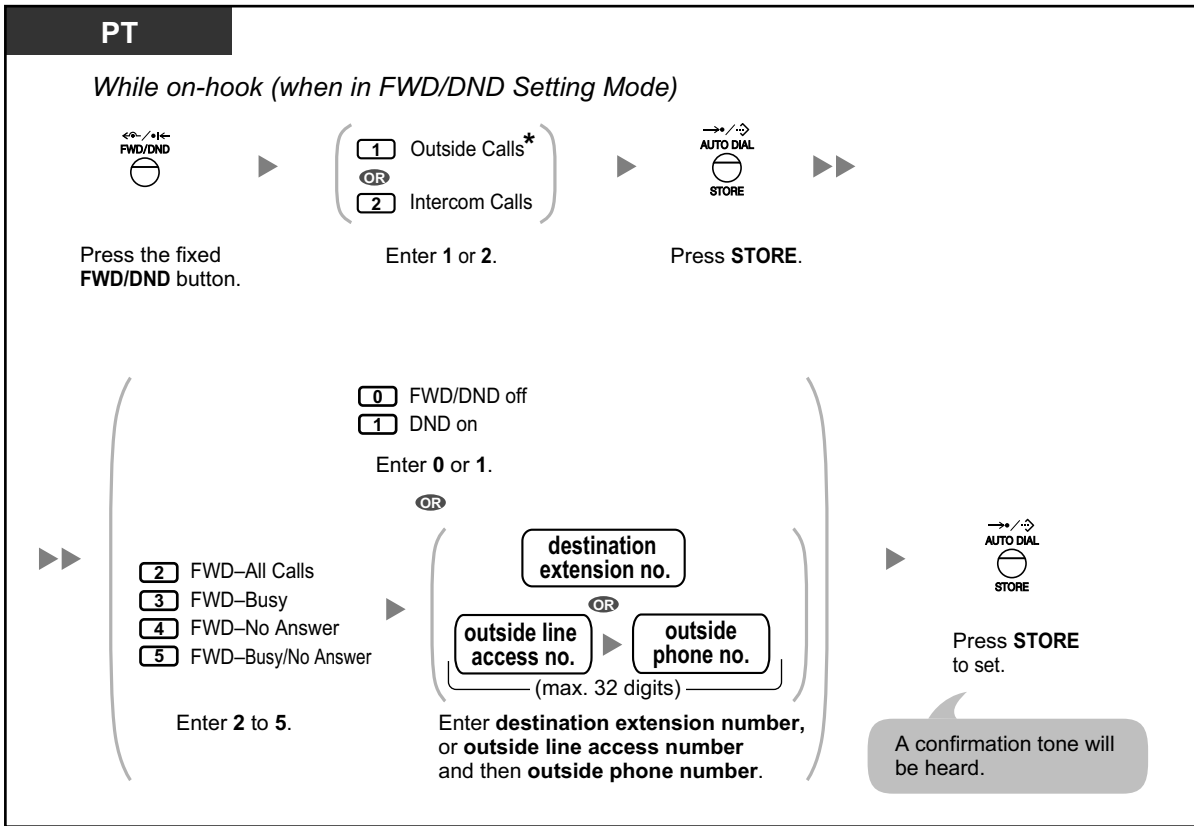

- \* This step can be omitted.

To set and clear FWD/DND for all calls

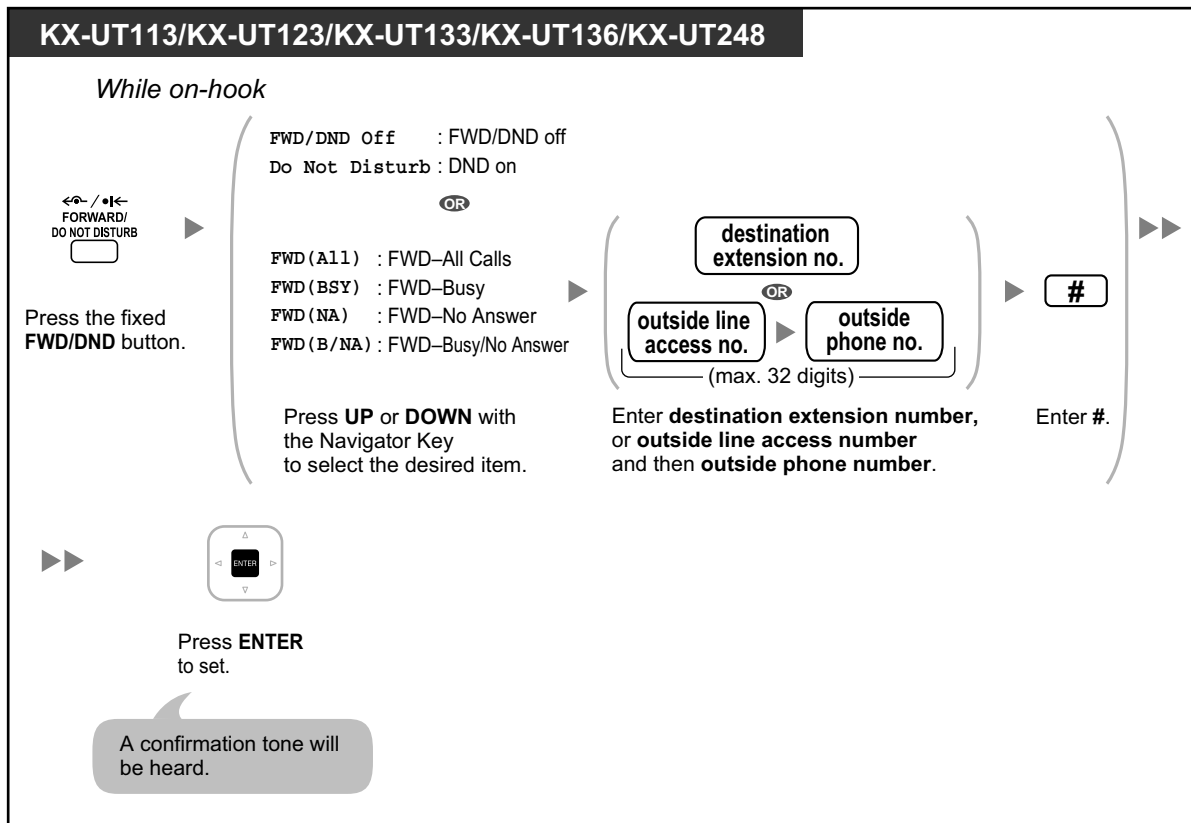

To set the timer for "No Answer" and "Busy/No Answer"

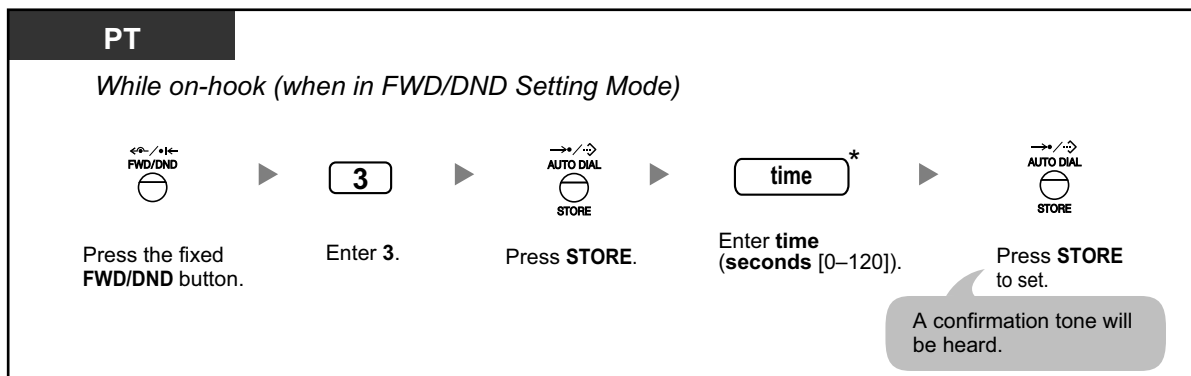

- \* You can enter the time as a 1-3 digit number. For example, 15 seconds can be entered as "15" or "015".

**To set forwarding status and outside destinations to ring in parallel for outside calls to an ICD Group**

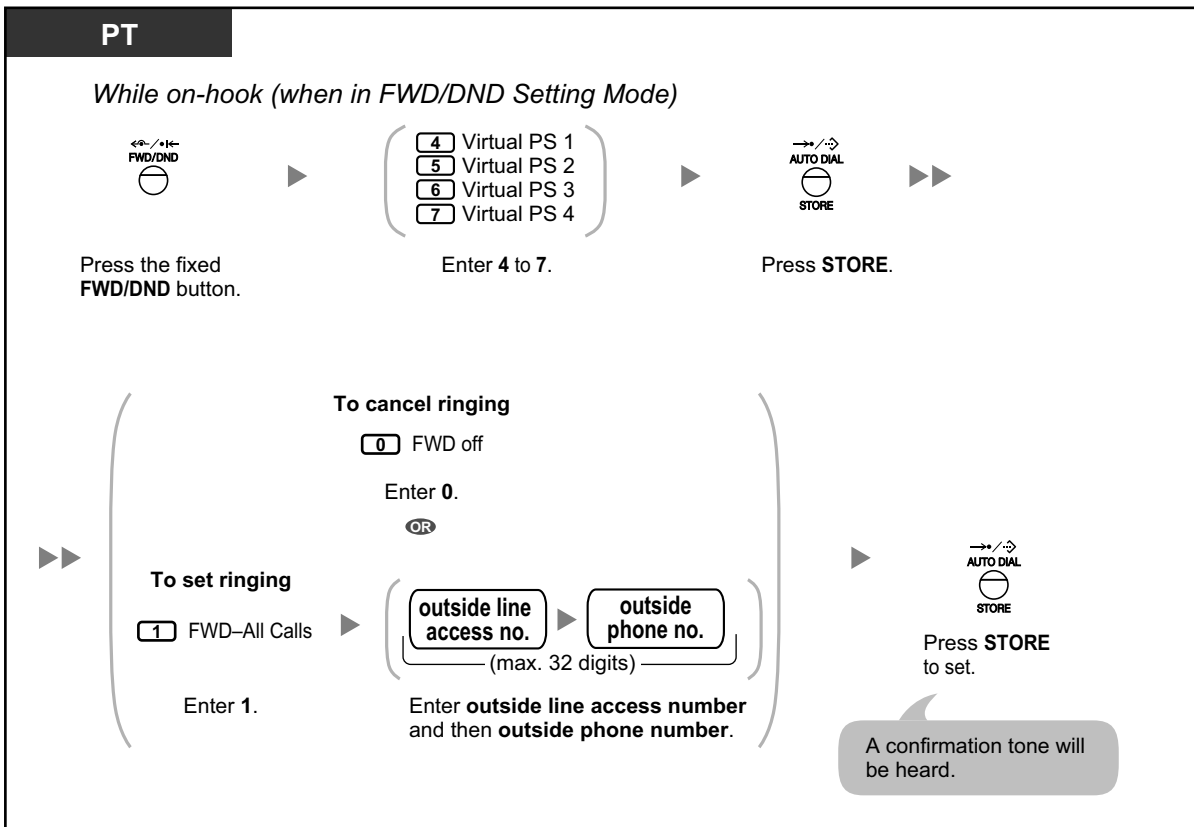

- Only one extension assigned as member 1 in each ICD group can perform the settings for virtual PSs.
- It is possible to switch the forwarding status (on/off) of a virtual PS by entering the number (4–7) of that extension, then pressing the fixed FWD/DND button, instead of pressing the AUTO DIAL/STORE button.

## ◆◆ Forwarding Your Calls Using ISDN Service (Call Forwarding [CF]—by ISDN)

All calls are forwarded to an outside party using ISDN. The following types of call forwarding are provided by the ISDN service.

- Unconditional (**Call Forwarding Unconditional [CFU]**)
- When your extension is busy (**Call Forwarding Busy [CFB]**)
- When you do not answer (**Call Forwarding No Reply [CFNR]**)

### To set

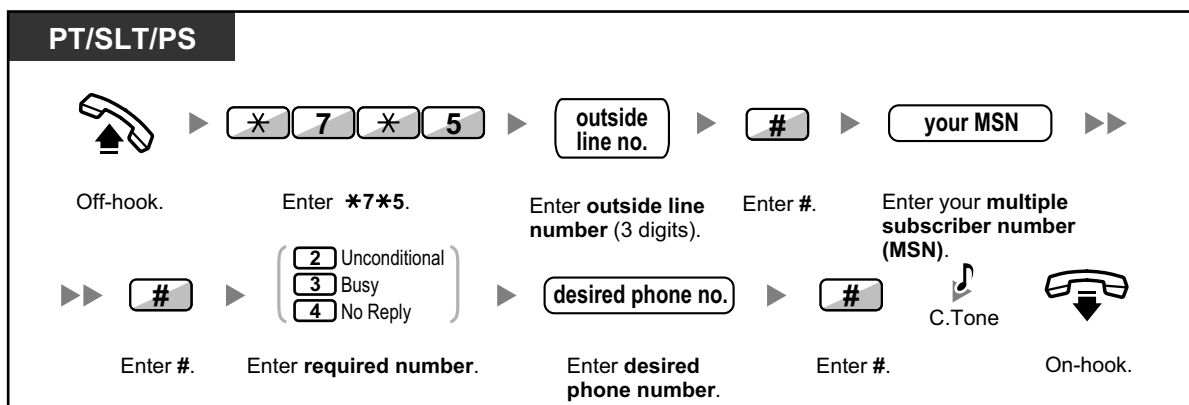

### To cancel

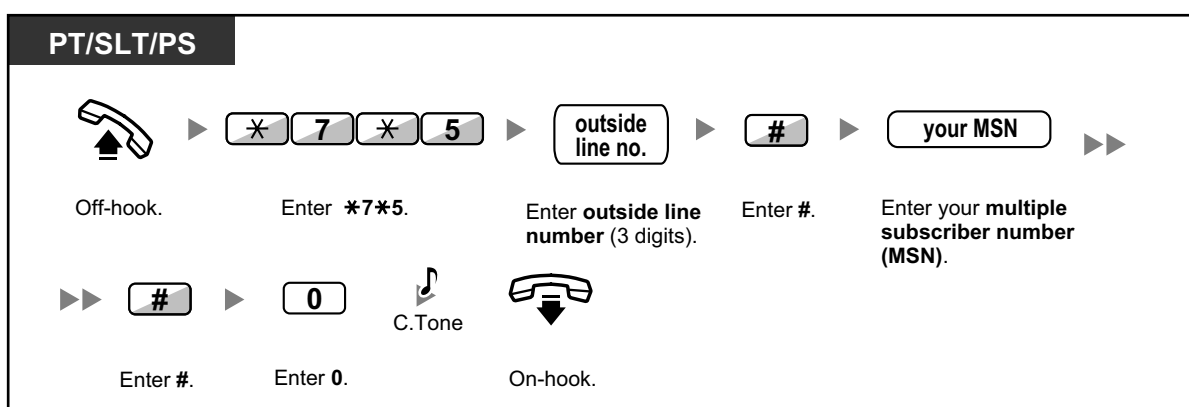

### To confirm the condition

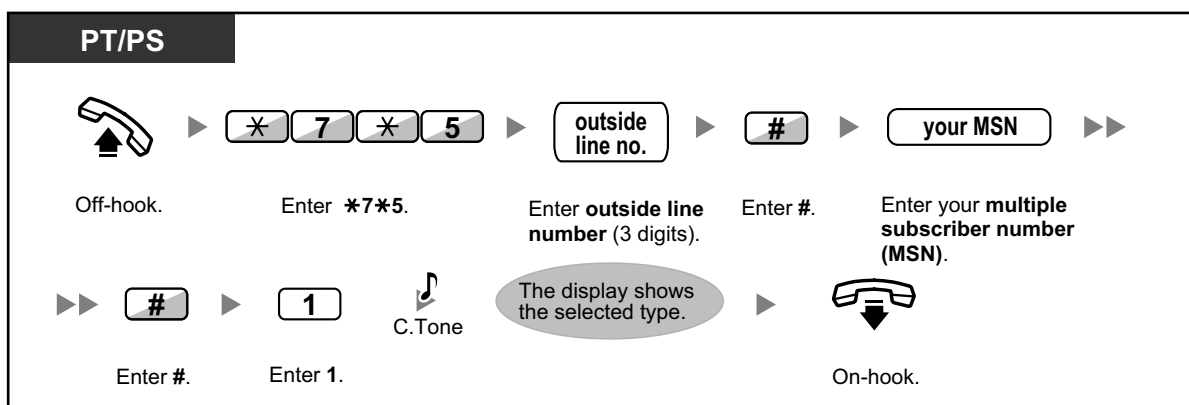

## 1.6.2 Showing a Message on the Caller's Telephone Display (Absent Message)

You can show the reason you do not answer, if the caller uses a Panasonic display proprietary telephone. There are eight preprogrammed messages and one for your personal message (16 characters). The selected message is shown on the display of your telephone. For callers using KX-UT series SIP phones or S-PSs, the message will not be shown on their display.

Message no.	Message (Example)
1	Will Return Soon
2	Gone Home
3	At Ext %%% (Extension number)
4	Back at %:% (Hour:Minute)
5	Out until %/% (Month/Day)
6	In a Meeting
7	
8	
9	A message assigned for each extension. (Personal Absent Message)

### To set

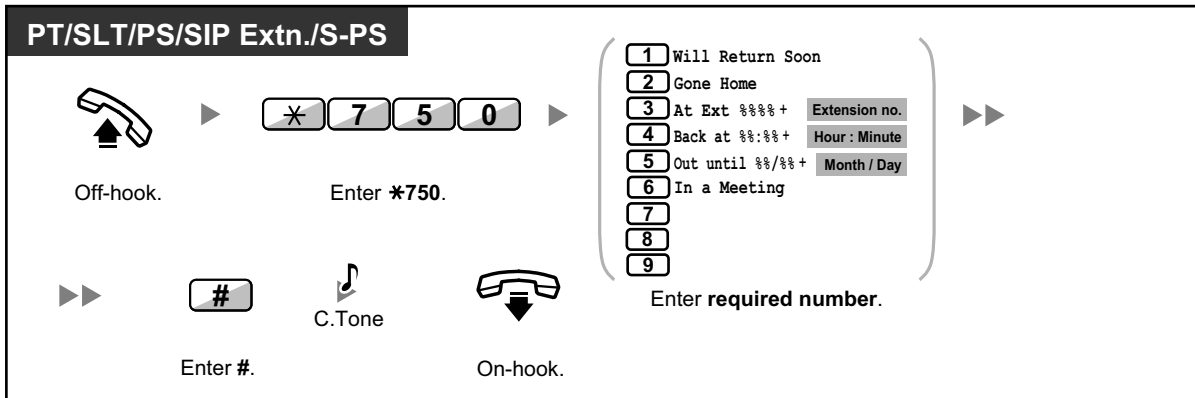

### To cancel

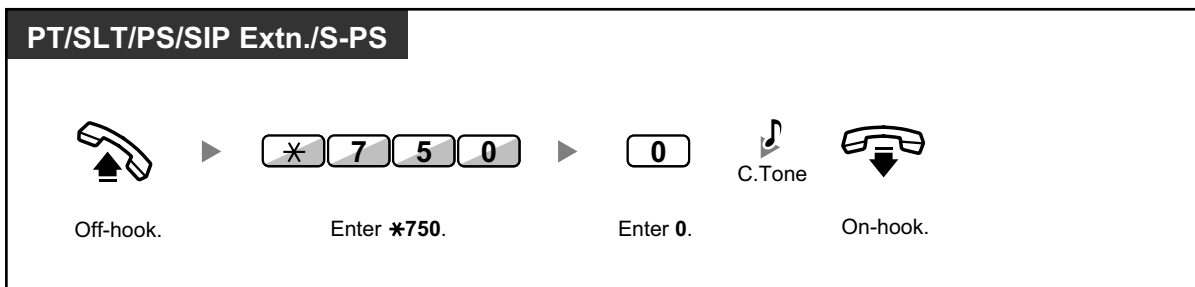



## 1.6.2 Showing a Message on the Caller's Telephone Display (Absent Message)

---



- Enter the desired value in the "%" positions. You must enter the correct number of characters as represented by the "%" using 0 to 9 or \*.
- The preprogrammed messages can be changed through system programming.
- To create your personal message (Message no. 9), refer to "3.1.2 Settings on the Programming Mode".

## 1.6.3 Preventing Other People from Using Your Telephone (Extension Dial Lock)

You can lock your extension so that other users cannot make unauthorised outside calls. This feature is also known as Electronic Station Lockout.

### To lock

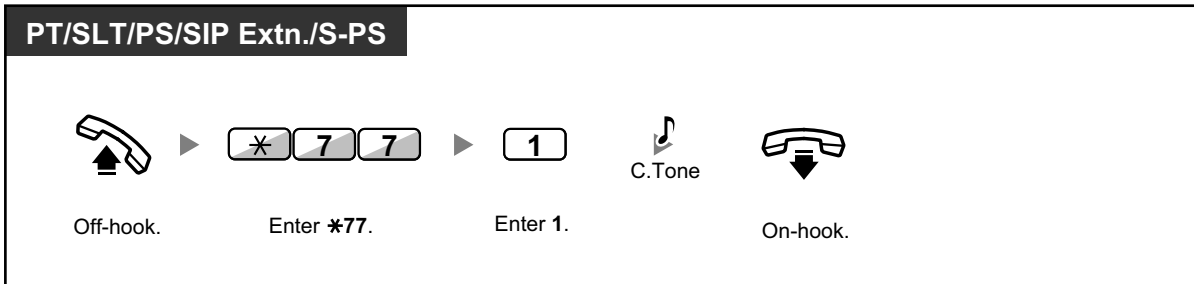

### To unlock

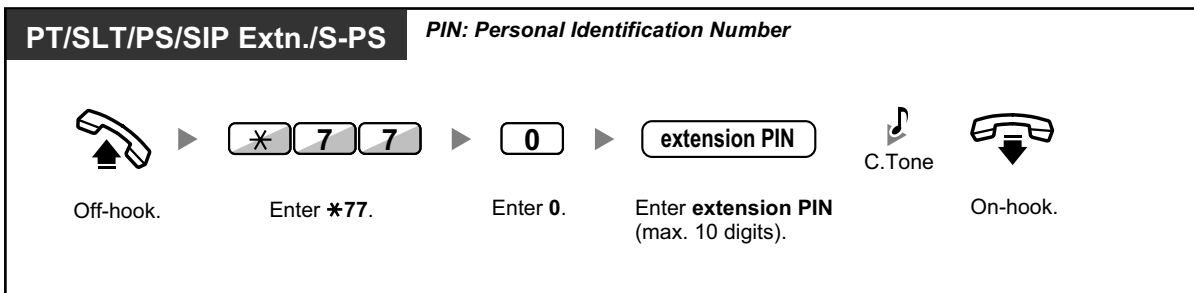

- **If you forget the extension PIN or cannot unlock your extension**, consult your manager. He can clear your extension PIN. Then, you can set the new PIN and unlock your extension by entering it.
- If your extension is locked by this feature, it cannot perform features as follows:
  - Making outside calls
  - Changing the call forwarding destination
- If you do not set extension PIN, you cannot lock and unlock your extension.

### To make an outside call while your extension is locked

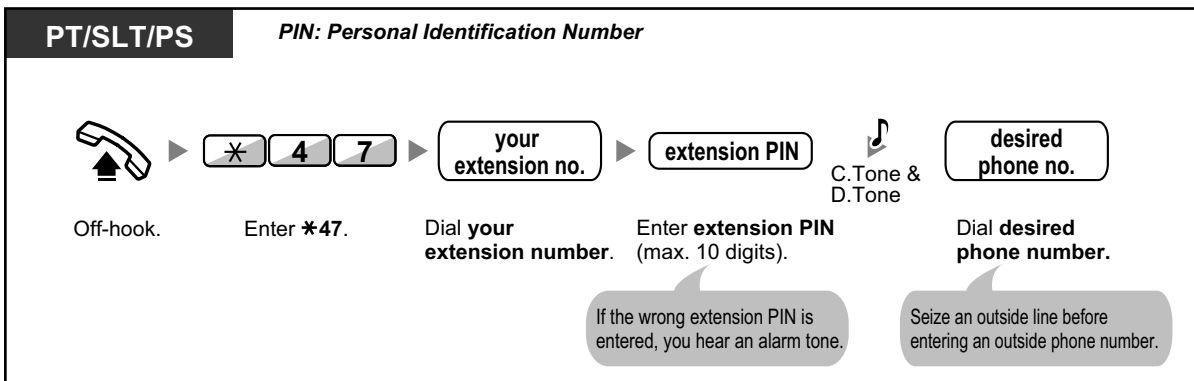



- After you make an outside call, Extension Dial Lock is automatically activated again.

## 1.6.4 Using Voice Messaging (Built-in Simplified Voice Message [SVM])

Your PBX can provide you with answering machine service.

Your extension is assigned a message box, into which callers can leave voice messages for you.

After callers reach your message box, they will hear your personal greeting message. You can record two kinds of personal greetings: a normal greeting message and a greeting message for each time mode. You can also play back and clear your greeting messages and the voice messages left by callers.

- ◆◆ Recording a Normal Greeting Message
- ◆◆ Recording a Greeting Message for Each Time Mode
- ◆◆ Redirecting Your Calls to Your Message Box
- ◆◆ Leaving Voice Messages
- ◆◆ Listening to Voice Messages Left by Callers
- ◆◆ Accessing Your Message Box from an Outside Telephone
- ◆◆ Accessing the Message Box of Another Extension from Your Extension



- This feature is not available for SIP Extensions. Even if a caller leaves a voice messages for a SIP Extension, the Message button light or Message/Ringer Lamp will not turn on to tell you that a voice message has been received.
- You may hear a busy tone when trying to access your message box if too many other users are already accessing their message boxes. In that case, wait a few minutes and try again.
- If the used recording space (including greeting messages and voice messages left by callers) for the SVM feature reaches a certain limit, the display informs you that the recording space is almost full, and you will hear dial tone 3 when going off-hook.

### Dial Tone 3



- **Operation Reference When Accessing Your Message Box**  
After entering the SVM feature number (\*38), the operations below are available by entering the corresponding numbers.

Operation No.	Operation
0	To clear the normal greeting message
1	To record a normal greeting message
2	To play back the normal greeting message
3	To listen to voice messages left by callers
8	To set a greeting message for each time mode
# 6	To leave a voice message to another extension's message box

## ◆◆ Recording a Normal Greeting Message

To record

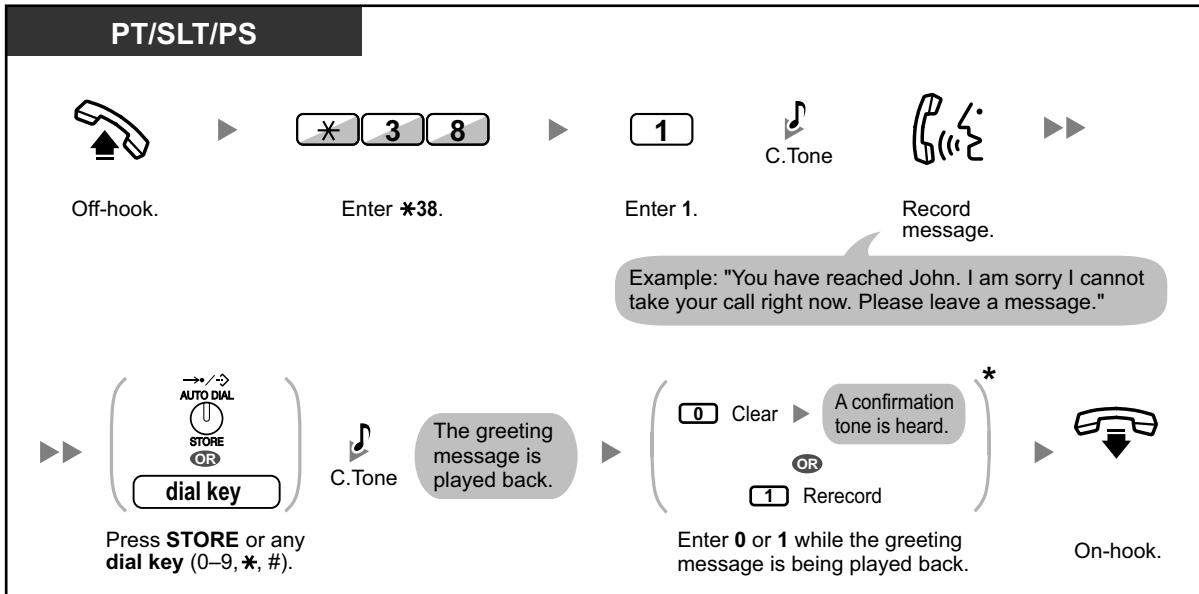

To play back

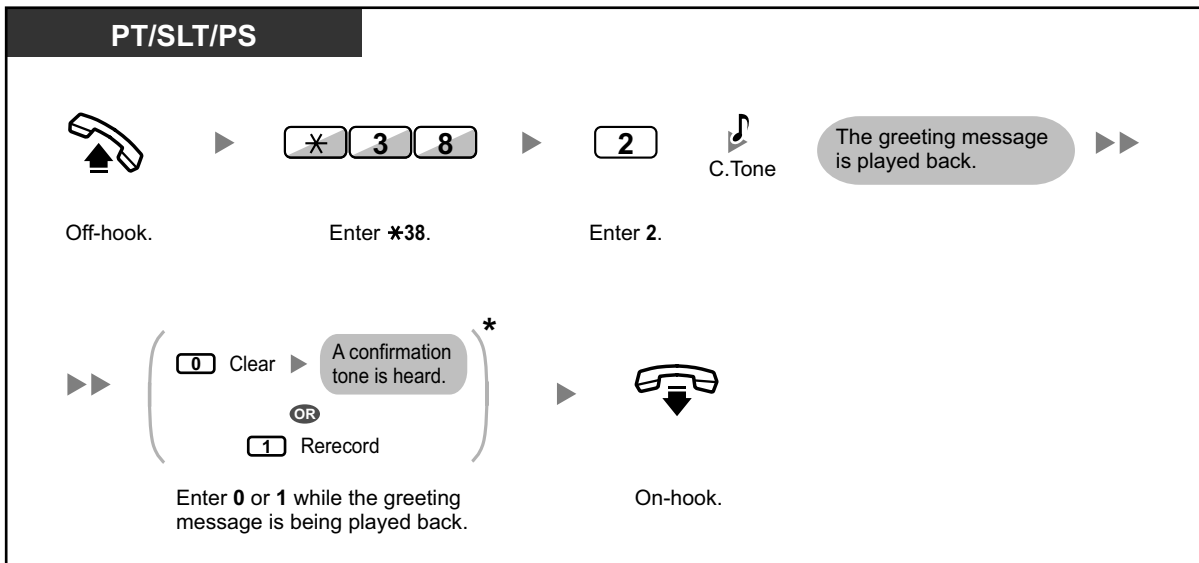

- \* This step can be omitted.

## 1.6.4 Using Voice Messaging (Built-in Simplified Voice Message [SVM])

### To clear

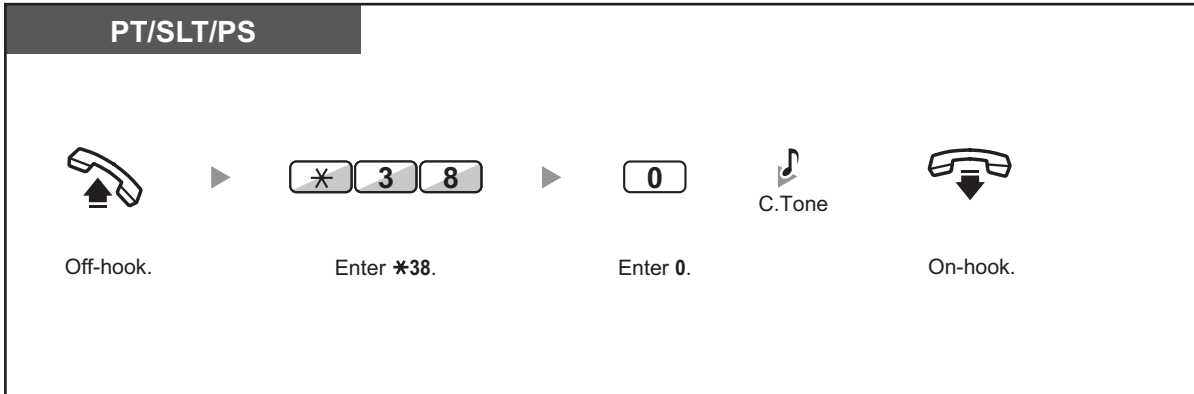

### ◆◆ Recording a Greeting Message for Each Time Mode

In addition to a normal greeting message, you can record a specific greeting message for each time mode (day/lunch/break/night).

### To record

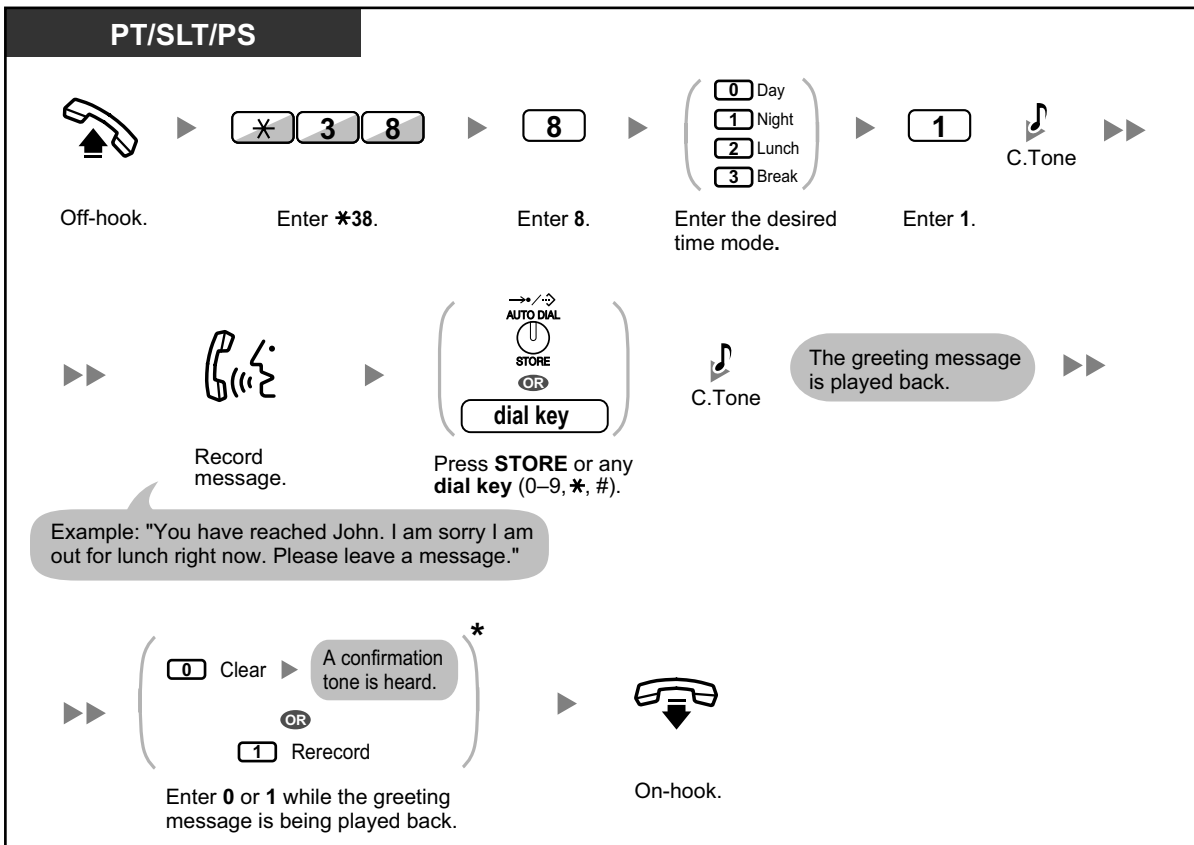

To play back

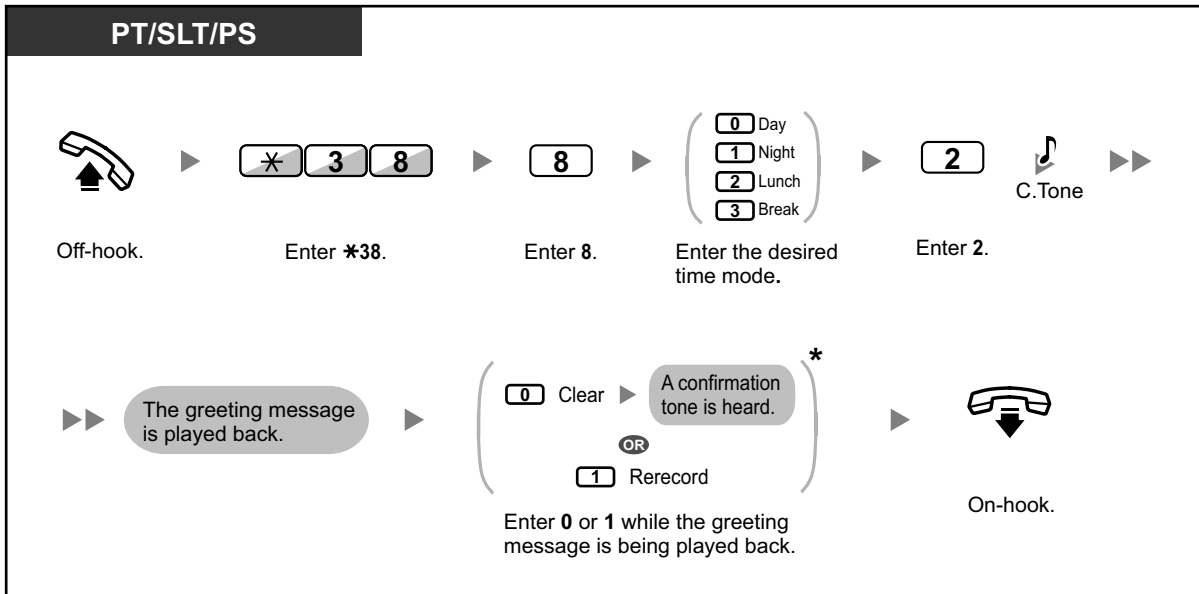

- \* This step can be omitted.

To clear

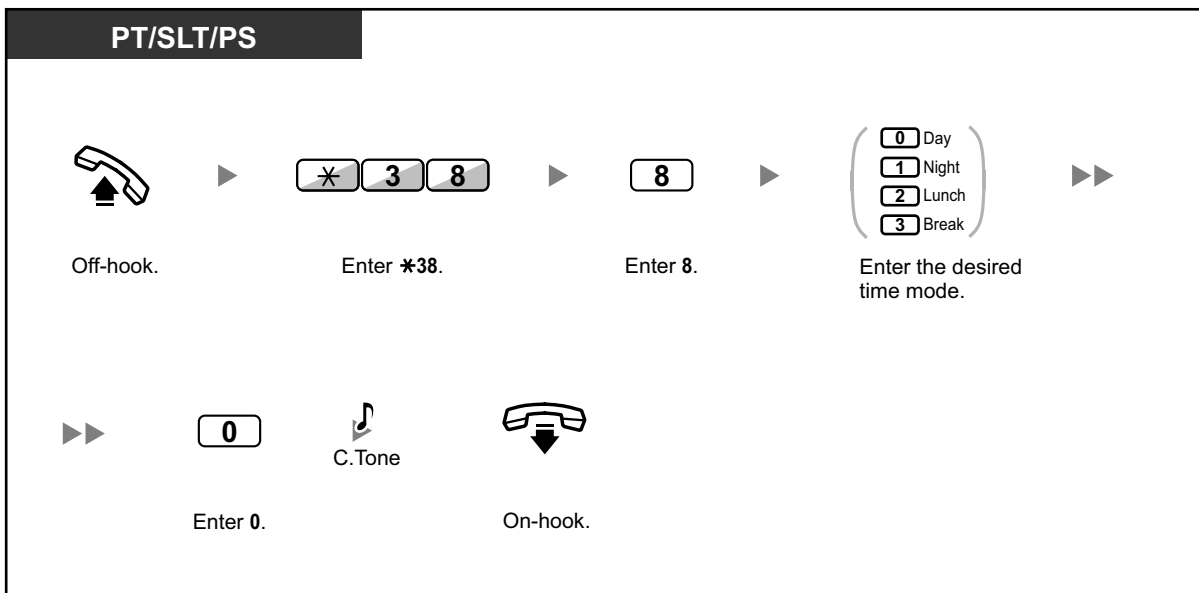

- If both the greeting message for a certain time mode and the normal greeting message have been recorded, callers will hear the greeting message for that time mode. However, if no greeting message has been recorded for a certain time mode, the normal greeting message will be played instead.

## ◆◆ Redirecting Your Calls to Your Message Box

You can set incoming calls to be redirected to your own message box so that callers can leave voice messages when you cannot answer the phone.

### To set/cancel

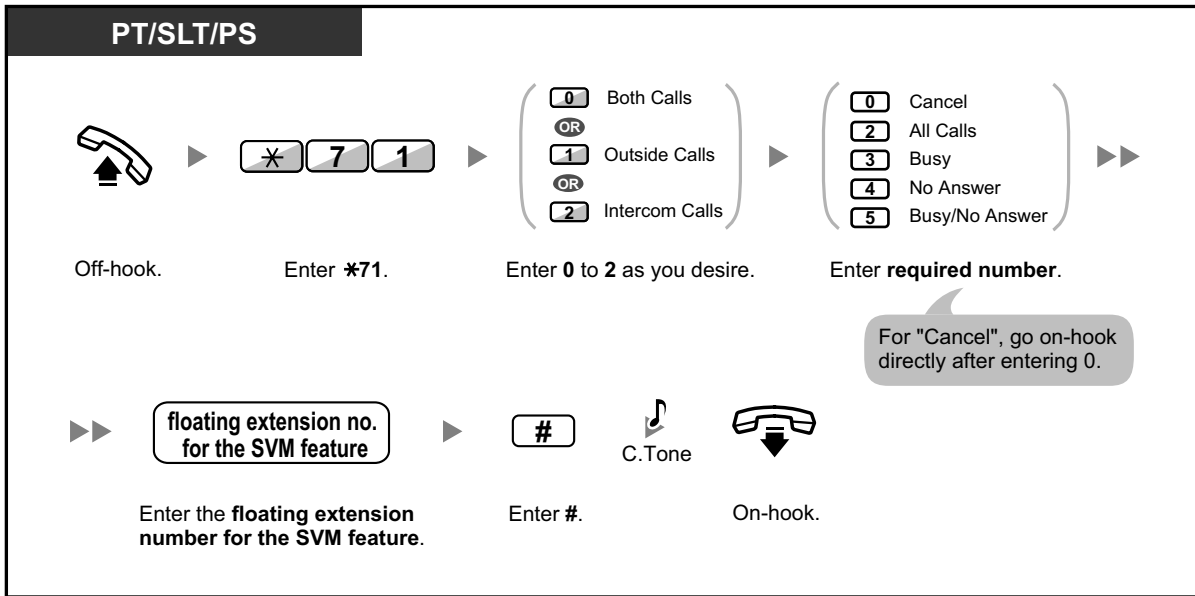

- The default floating extension number for the SVM feature is 591.



## ◆◆ Leaving Voice Messages

If the extension user you called is not able to answer your call, and your call is redirected to the message box, you will hear the greeting message. Then, you can leave a voice message for that extension. It is also possible to leave a voice message directly in the message box of a desired extension by following the steps below:

### To leave a voice message directly to another extension's message box

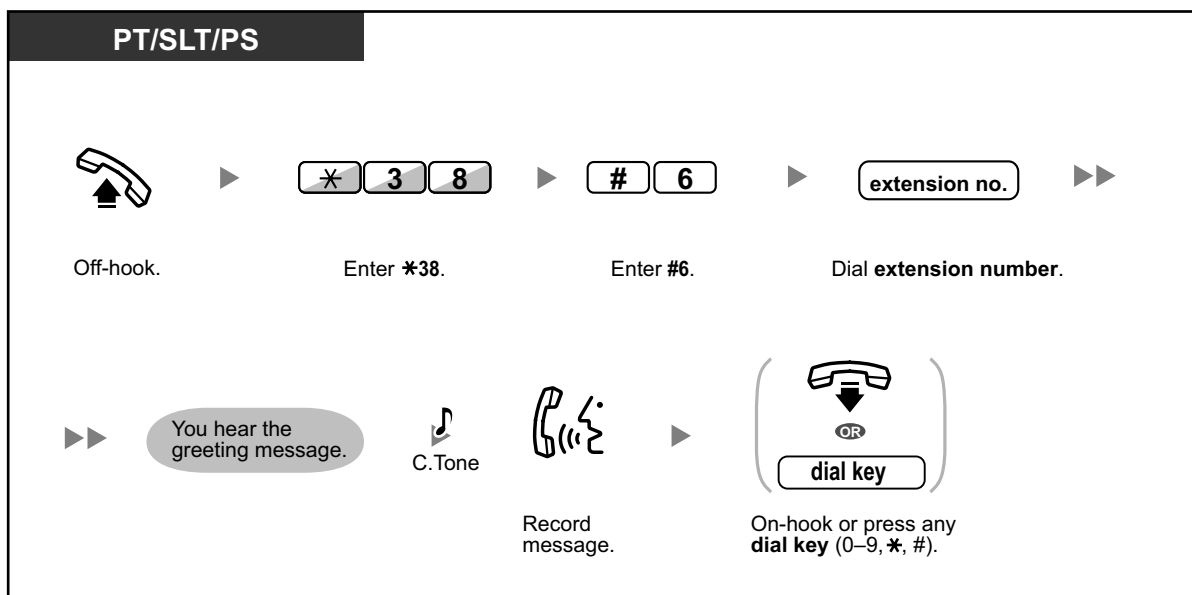

- Voice message recording will stop, you will hear a notification tone, and the call will be disconnected, in the following cases:
  - the recording time for the voice message reaches the preprogrammed limit. (default: 120 seconds)
  - the recording space for the SVM feature reaches the limit.



- When you are on the phone, you can transfer the call directly to the message box of a desired extension by placing the call on hold temporarily, then pressing \*38 + #6 + the desired extension number. This allows the caller to leave a voice message in the message box of the desired extension.

## ◆◆ Listening to Voice Messages Left by Callers

When a caller leaves a voice message, information about that caller is also recorded as the SVM Log. The SVM Log can be viewed using the display of a PT or PS by pressing the Message button.

### To listen to voice messages

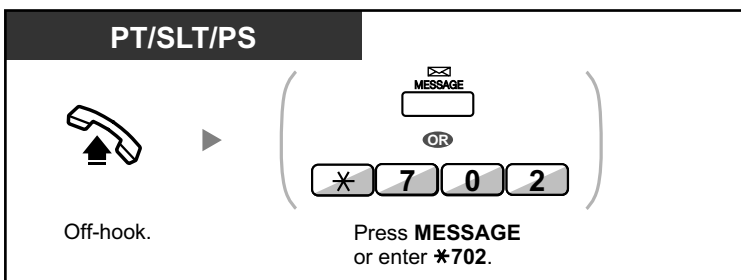
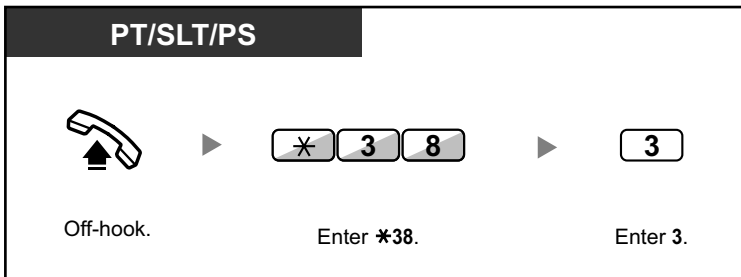
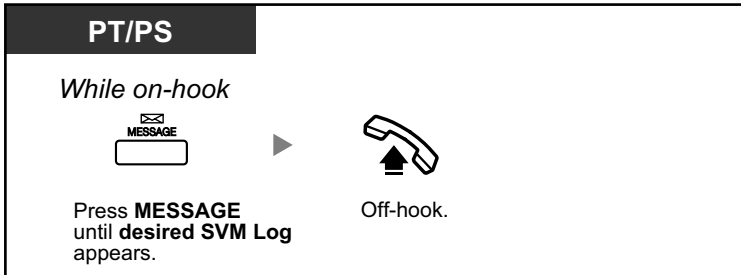

### To clear the voice message that you are listening to

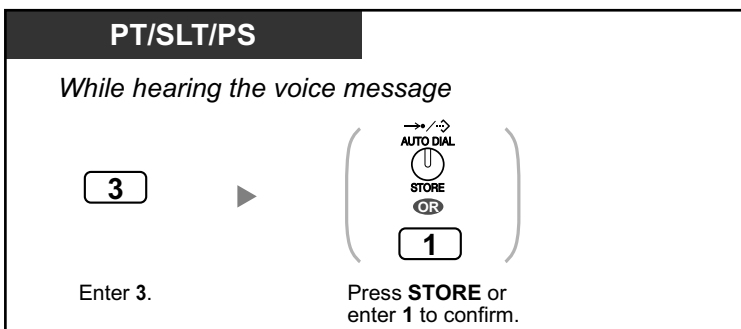

- Various operations are available by entering numbers while you are listening to a recorded voice message using any of the methods described above. The available options are as follows:

Operation No.	Operations
1 / # *	To play back the voice message from the beginning
2	To go to the next voice message
3	To clear the voice message (Press the AUTO DIAL/STORE button or enter 1 to confirm.)
4	To call back the caller who left the voice message
5	To go back to the previous voice message
# 6	To leave a voice message directly in the message box of another extension (Enter desired extension number.) If you cannot input the desired extension number within the specified time, play back the voice message from the beginning. If you enter an incorrect number for the desired extension number, you will hear a reorder tone.
# 8	To play back your greeting message and record a voice message in your own message box
# 9	To end the call

The operation numbers above may be changed to other numbers. If you cannot activate these operations, consult your system administrator.

- In addition to the caller information that is recorded in the Call Log, the following SVM Log information is recorded with voice messages left by callers:
  - Caller's Name
  - Caller's Telephone Number
  - Time recording started
  - Voice Message Status
    - "New" is displayed for voice messages that have not previously been listened to.
    - "Old" is displayed for voice messages that have previously been listened to.

Please note that the information shown on the display may vary depending on the information that was received and the type of telephone used. Only users of a 6-line display PT can view all of the above information.
- You can lock the SVM Log display by using an extension PIN (Personal Identification Number) to prevent other users from viewing the information and from playing back your voice messages (Display Lock). Refer to "3.1.2 Settings on the Programming Mode".
- If your telephone has a Message for Another Extension button, you can access the message box of another extension and listen to voice messages for that extension.
- If a new voice message has been left in your message box, you will hear dial tone 4 after going off-hook. In addition, if your telephone has a Message button or Message/Ringer Lamp, the corresponding button or lamp will light when a voice message has been left.

#### Dial Tone 4



To listen to voice messages while your display is locked

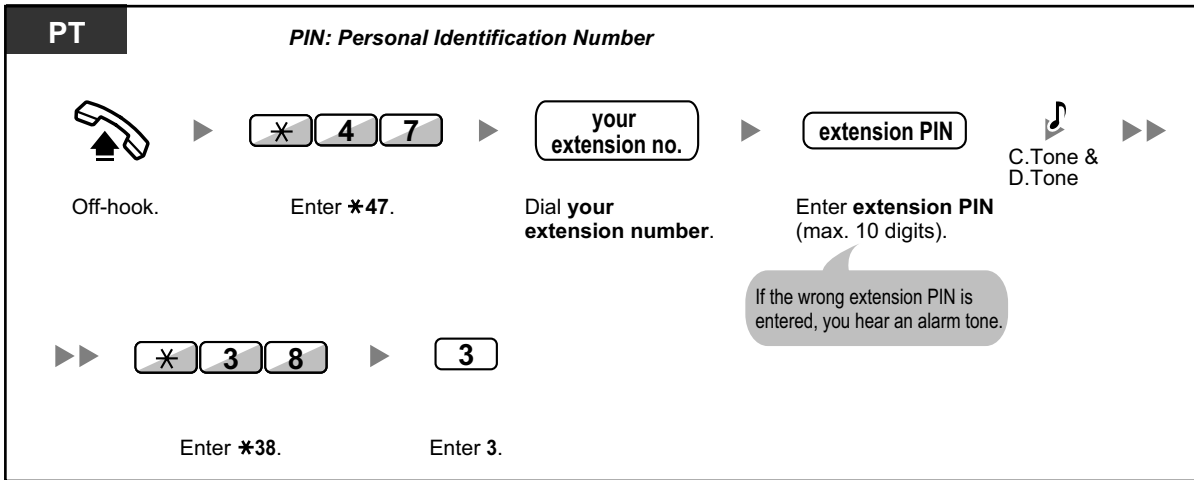

- When you press the Message button to play back voice messages while on-hook, Display Lock is temporarily deactivated after you enter the PIN.

To clear voice messages from the SVM Log

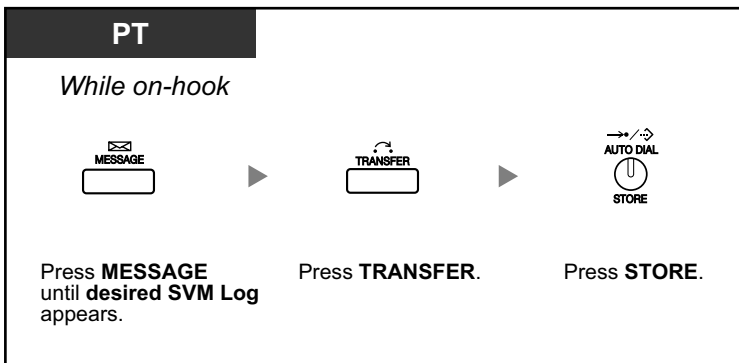

## ◆◆ Accessing Your Message Box from an Outside Telephone

You can remotely access your message box and perform any operations of the SVM feature through an outside line as if you were at your own extension.

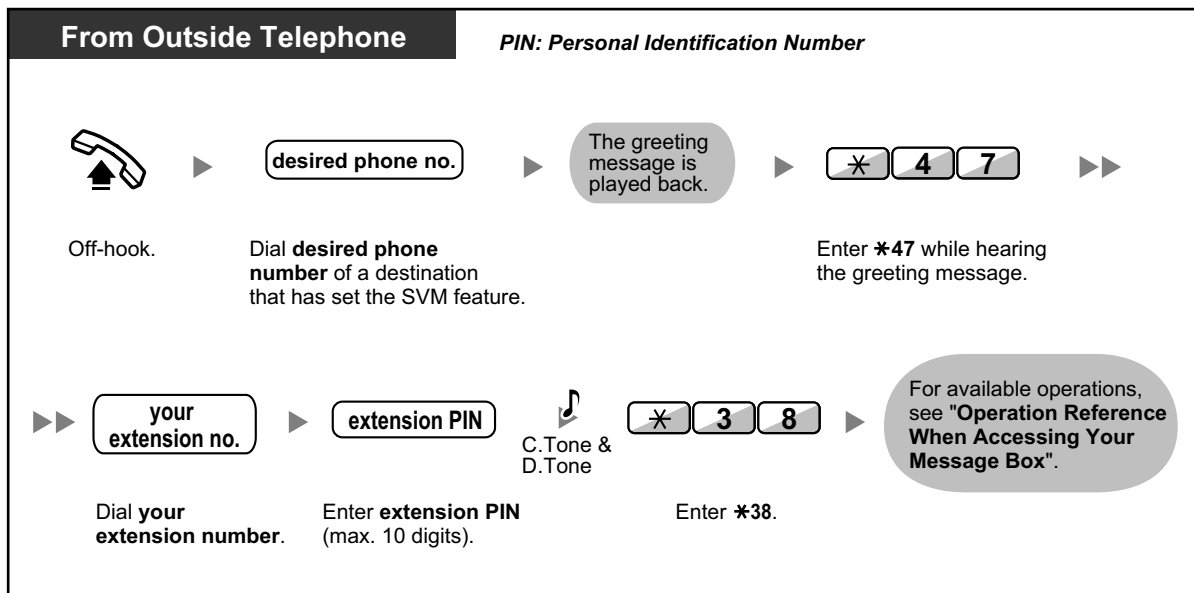

- If you hear a reorder tone when you try to leave a voice message directly in the message box of another extension, that message box is unavailable. You can enter another extension number by pressing "\*".
- When accessing your message box from an outside telephone, you cannot call back callers who have left voice messages, by pressing 4 while hearing the voice message.

### To listen to voice messages left in the message box of another extension

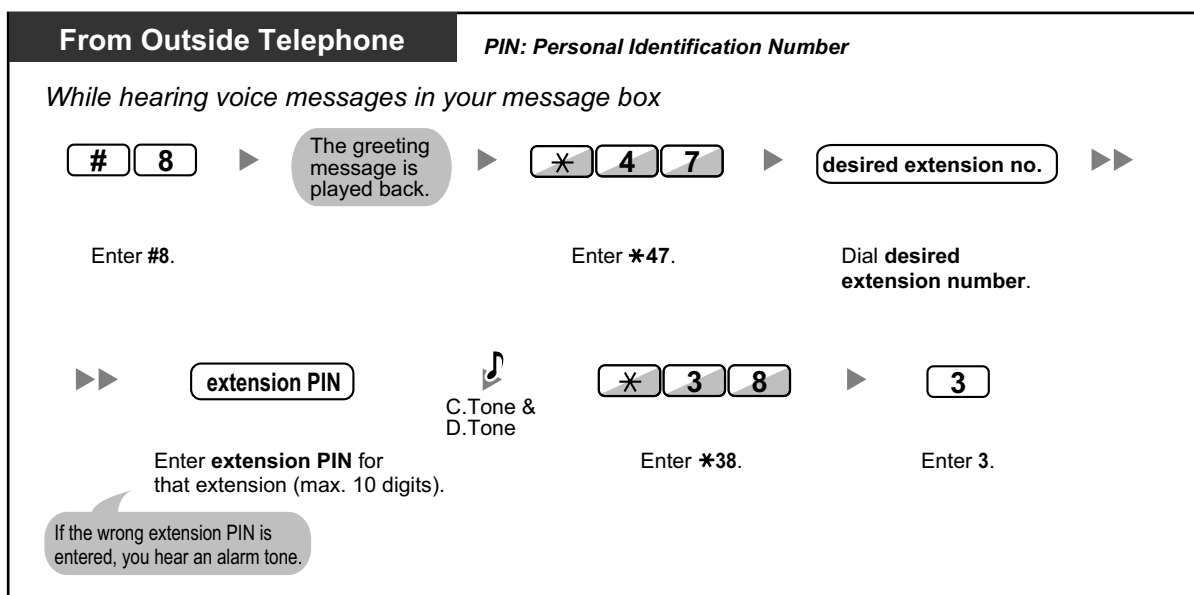

## ◆◆ Accessing the Message Box of Another Extension from Your Extension

You can access the message box of another extension (for example, to record a greeting message for that extension) by following the steps below:

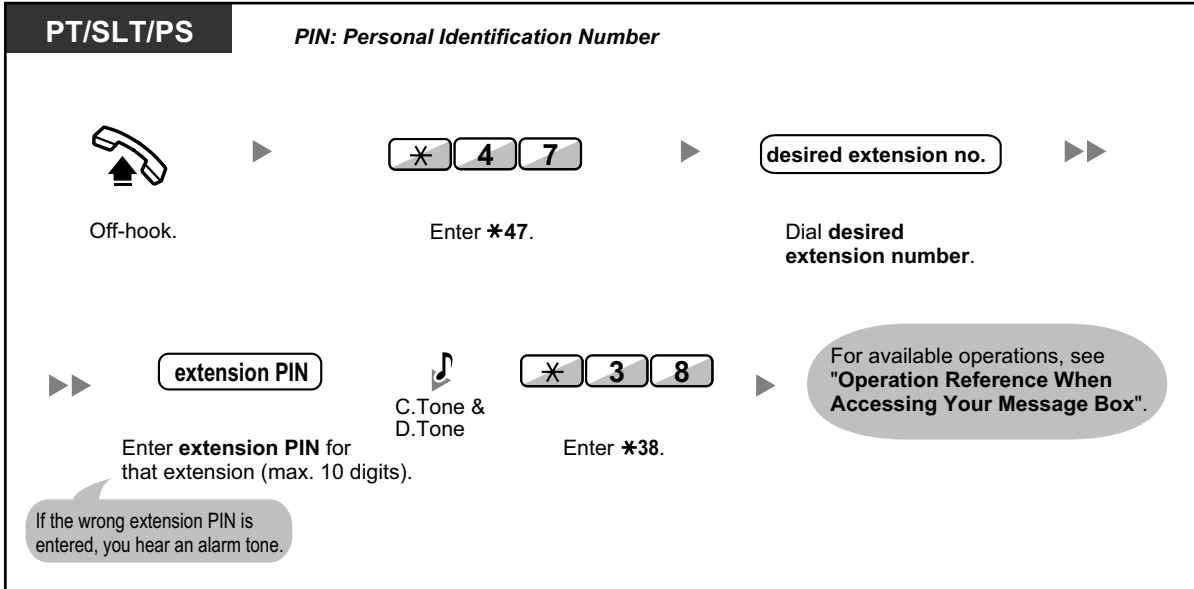

## 1.7 Making/Answering an Announcement

### 1.7.1 Paging

- ◆◆ Group Paging
- ◆◆ Paging and then Transferring a Call

#### ◆◆ Group Paging

You can make a voice announcement to proprietary telephones or external speakers or both in the preset group simultaneously.

##### To page

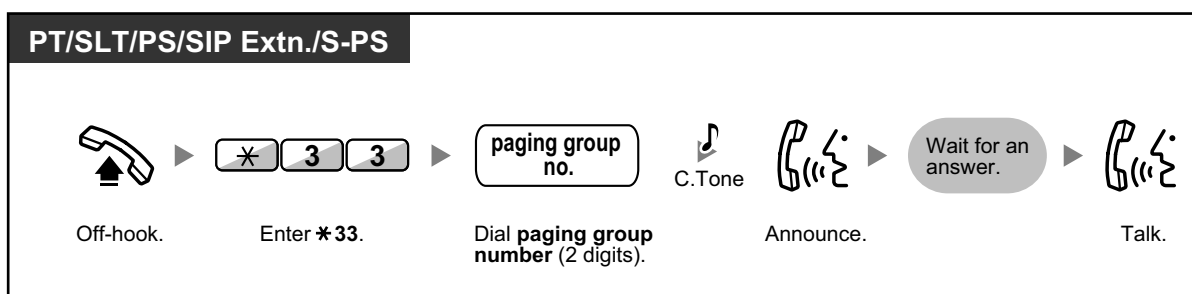

- If the group which you paged is already being used for paging, you hear a busy tone.

## ◆◆ Paging and then Transferring a Call

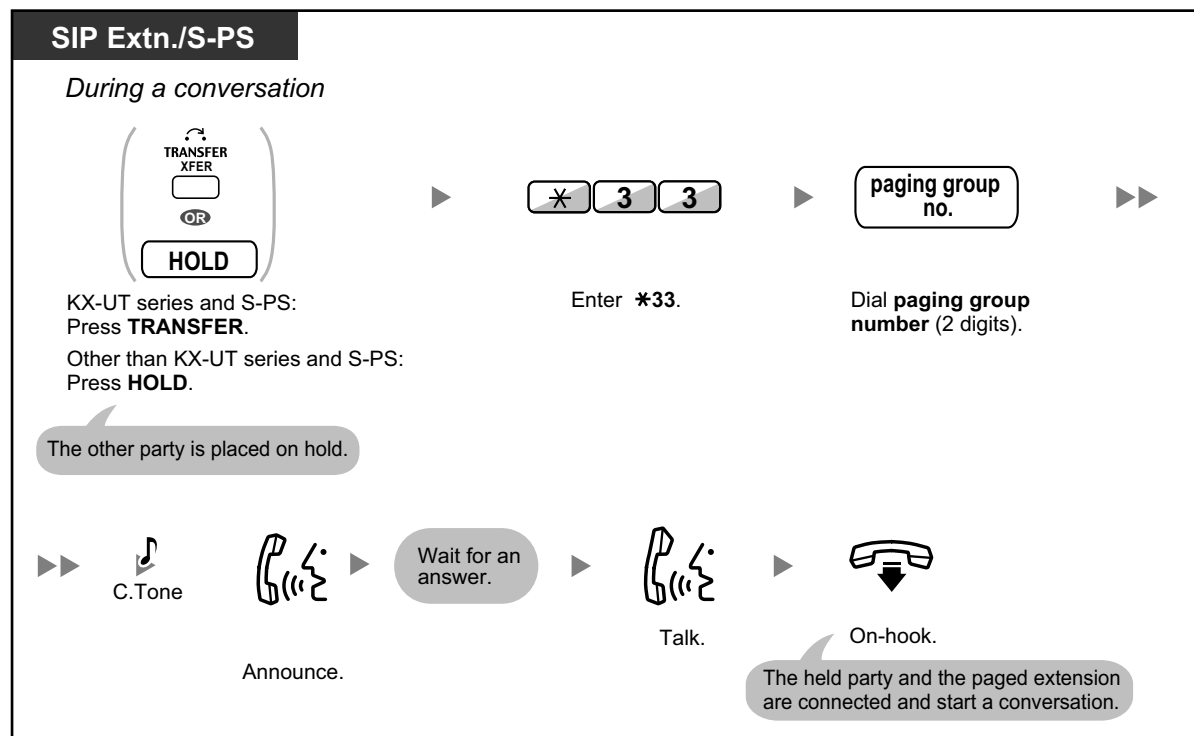
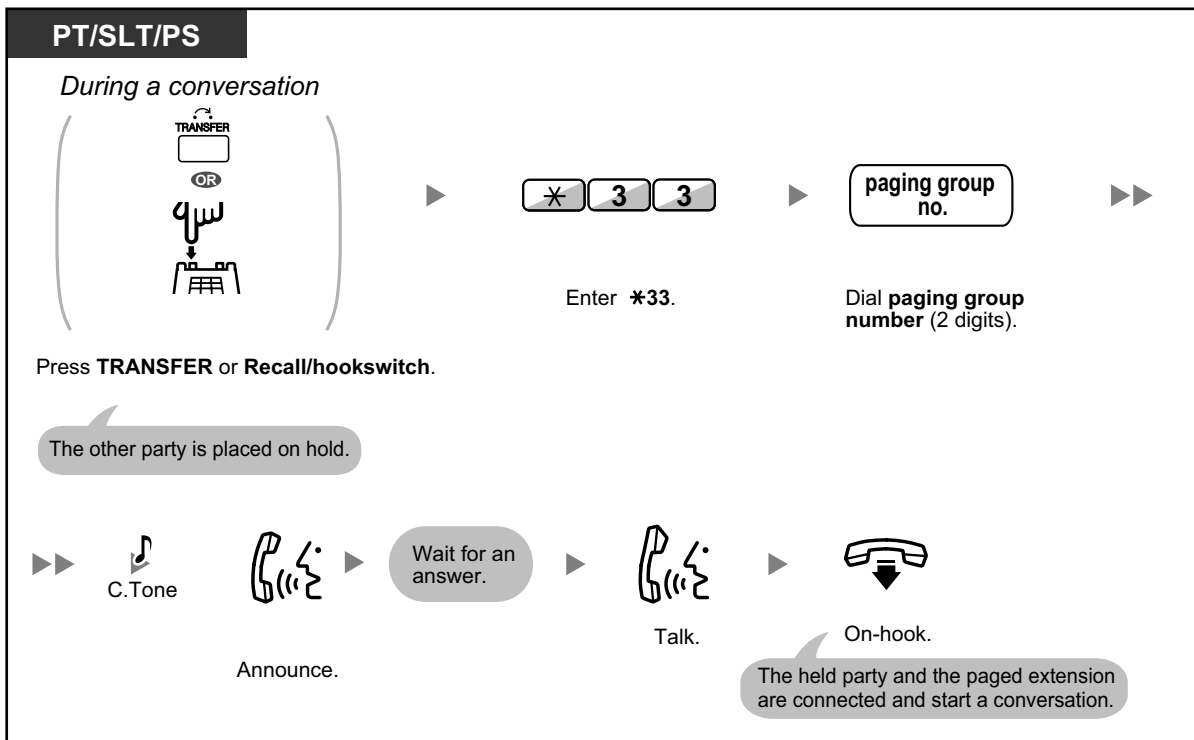

- After you go on-hook, the caller can talk to the person who answers the page.



## 1.7.2 Answering/Denying a Paging Announcement

To answer

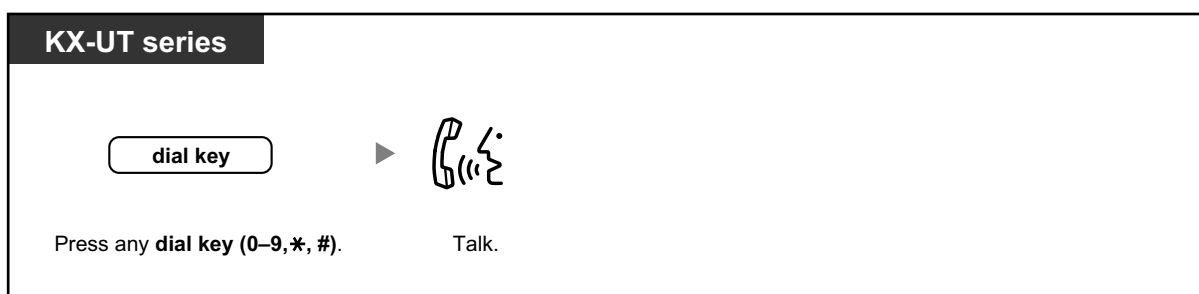
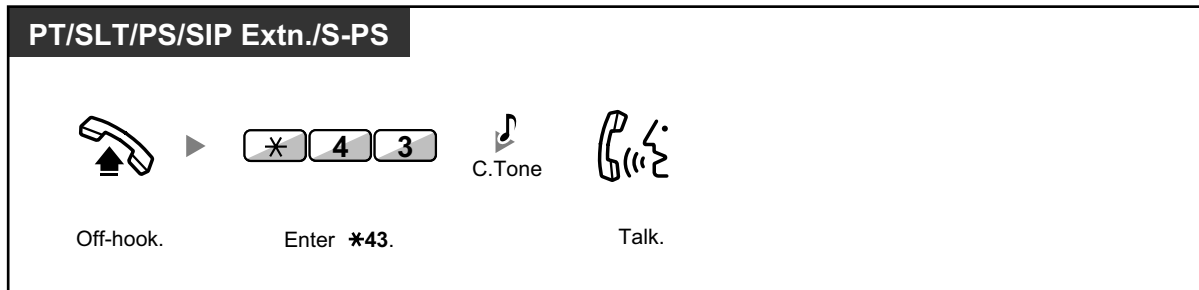

To allow/deny a paging announcement (Paging Deny)

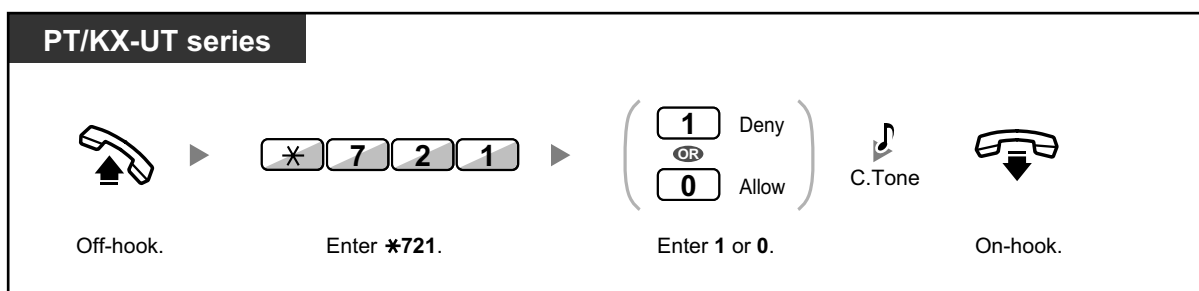

- The following are extensions that cannot receive a paging announcement:
  - Portable station
  - Single line telephone
  - Proprietary telephone that is ringing or busy
  - Proprietary telephone in Paging Deny mode
  - Proprietary telephone in DND mode
  - Non-KX-UT series SIP phone
  - SIP-CS compatible Portable Station
- System programming may be required for some IP-PT users to receive paging announcements.
- Even if the announcement is not paging your extension, you can answer it, if it is paging your group.

## 1.7.3 Making a Conference Group Call

You can call multiple parties, assigned as members of a group (conference group), and establish a multiple party conversation with the called parties. You can make a conference group call to both extensions and outside lines (including analogue lines). The following two modes are available:

- **Conference Mode:** the called parties can join the conversation automatically. (◆◆ Conference Mode)
- **Broadcast Mode:** the called parties can hear the caller's voice announcement, and then be allowed to join the conversation by the caller. (◆◆ Broadcast Mode)



- If you dial a conference group number that is in use for another conversation, you will hear a busy tone and cannot establish a multiple party conversation.
- If you fail to seize idle outside lines necessary for all members assigned in the conference group, you will hear a reorder tone and cannot make a conference group call.
- When making a conference group call to an outside party, the CLIP number for that call will be the one you select for making calls to an outside line. Refer to "1.9.4 Displaying Your Telephone Number on the Called Party and Caller's Telephone (Calling/Connected Line Identification Presentation [CLIP/COLP])".

### ◆◆ Conference Mode

If this mode is selected through system programming, the called parties can join the conversation simply by going off-hook. The caller can end the conversation with a specific party manually.

#### To make/answer a conference group call (for both extension and outside line)

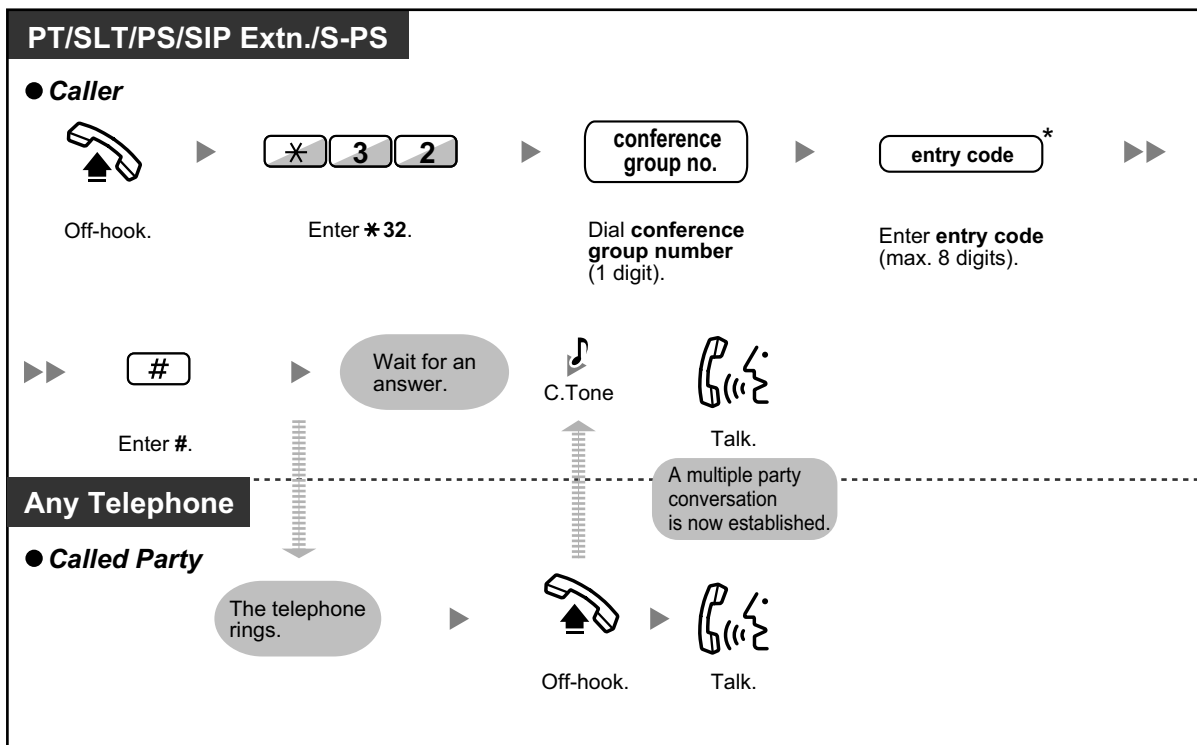



- \* If you do not enter an entry code when making the conference group call, extensions/outside telephones can join the conversation without needing to enter an entry code.
- Entry codes can consist of the digits "0" through "9". When "\*" is used for an entry code, no one can join a conversation that is already in progress. For details, refer to "◆◆ Join After Time Out".
- A conversation can be established with a maximum of 8 parties (including the caller).
- If the Hands-free Answerback feature is enabled, the called extension can answer the conference group call without going off-hook.
- With PTs and KX-TCA175/KX-TCA275/KX-TCA185/KX-TCA285/KX-TCA385 PSs, a conference group call can be automatically answered without going off-hook. This mode is selected through system programming.
- If using an SLT, SIP phone, or S-PS, the caller can only originate a conference group call and cannot control the called parties' call status manually.

### ◆ For a caller

#### To end a conversation with a specific party

PT/PS

*During a conversation*

- **To end a conversation with a specific party**



(DSS)

Press **DSS**.

- **To end a conversation with the party who joined the conversation last**



Press **TRANSFER**.

- **To disconnect the party who joined the conversation last from the conference group call**



Press **FLASH/RECALL**.



- In this case, the FLASH/RECALL button must be set to Flash/Recall mode through system programming.

## ◆◆ Broadcast Mode

If this mode is selected through system programming, the caller can call multiple parties in a conference group, make a voice announcement, and then establish a multiple party conversation with the called parties. This conversation will be heard by all called parties. Called parties can listen to the announcement simply by going off-hook. They can send a notification tone if they want to join the conversation.

To make/answer a conference group call (for both extension and outside line)

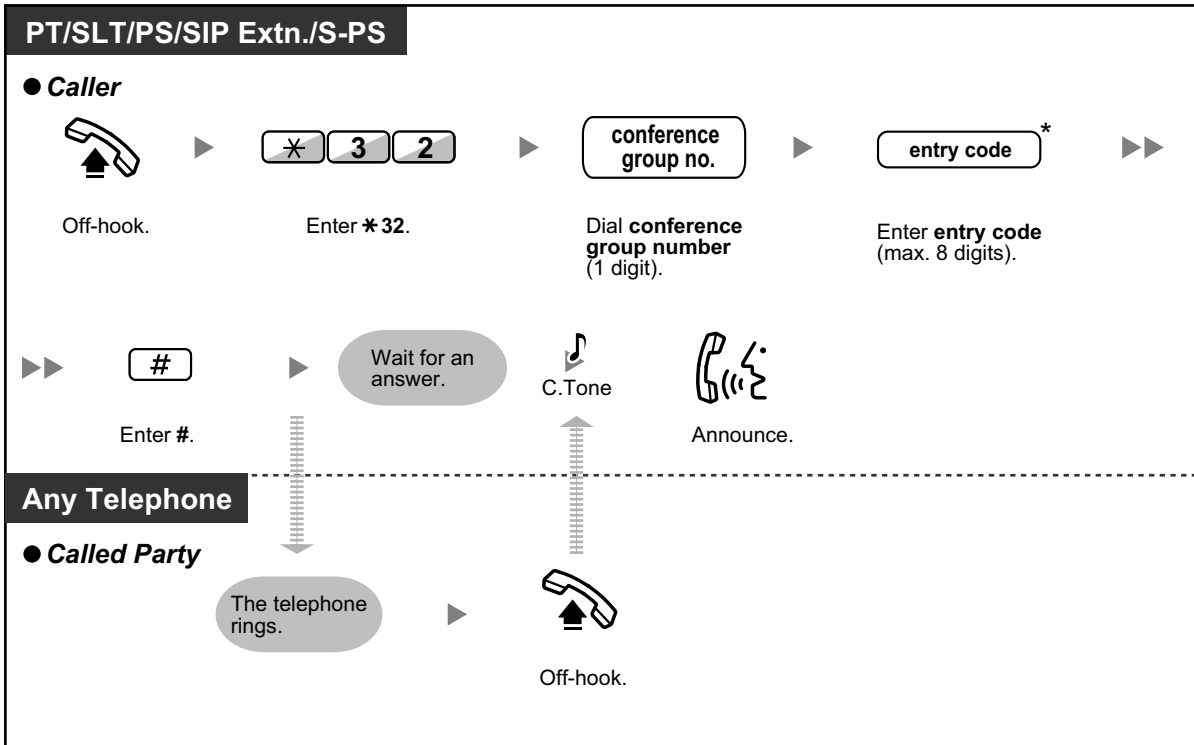

- \* If you do not enter an entry code when making the conference group call, extensions/outside telephones can join the conversation without needing to enter an entry code.
- Entry codes can consist of the digits "0" through "9". When "\*" is used for an entry code, no one can join a conversation that is already in progress. For details, refer to "◆◆ Join After Time Out".
- With PTs and KX-TCA175/KX-TCA275/KX-TCA185/KX-TCA285/KX-TCA385 PSs, a conference group call can be automatically answered without going off-hook. This mode is selected through system programming.
- If the Hands-free Answerback feature is enabled, the called extension can answer the conference group call without going off-hook.
- If using an SLT, SIP phone, or S-PS, the caller can only originate a conference group call and cannot control the called parties' call status manually.

◆ For a caller

To make a conversation with a specific party



### To make a conversation with a party in the group's preassigned order

PT/PS

*During an announcement*



Press **CONF**.



- When you press the CONFERENCE/CONF/Conference button after pressing a DSS Key, you will make a conversation with the party who registered after the current party on call in the Conference Group.

### To end a conversation with a specific party

PT/PS

*During a conversation*

- **To end a conversation with a specific party**



Press **DSS**.
- **To end a conversation with the party who joined the conversation last**



Press **TRANSFER**.
- **To disconnect the party who joined the conversation last from the conference group call**



Press **FLASH/RECALL**.



- In this case, the FLASH/RECALL button must be set to Flash/Recall mode through system programming.
- If the maximum number of parties who can actively participate in the conversation is set to 32 through system programming, the keys on the conference originator's telephone (DSS, CONFERENCE, TRANSFER, FLASH, etc.) will not function.

◆ For a called extension

To send a notification tone to the caller and join a conversation

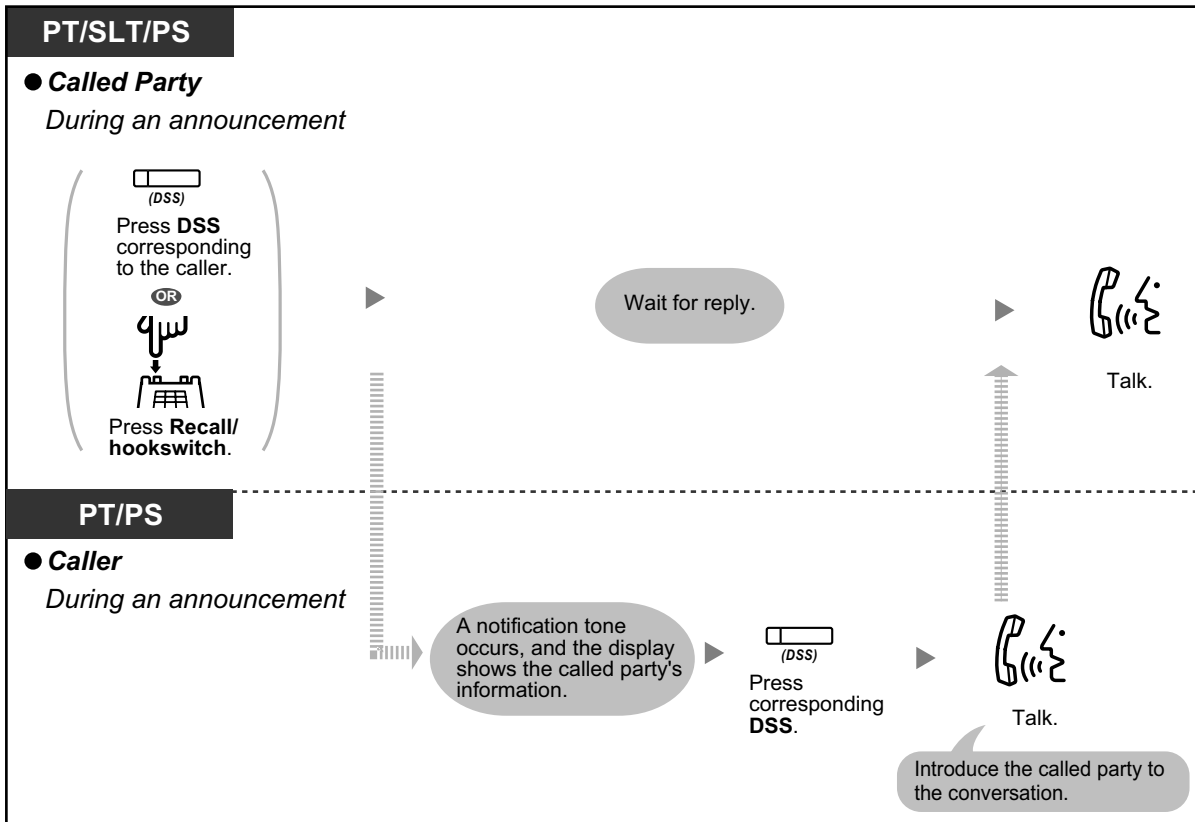

- A maximum of 32 parties (including the caller) can join the conference. Also, depending on system settings, a maximum of 32 parties (including the caller) can join the conversation.



• **Push-to-Talk for PT/SLT/PS users**

If the Broadcast Mode and this mode are selected through system programming, the called PT/SLT/PS users can join the conversation by pressing any dial key (0–9, \*, #) during the voice announcement.

By assigning PSs with the Hands-free Answerback feature enabled to a conference group, the caller can create a wireless paging system. All of the called PS users, with the Hands-free Answerback feature enabled, will hear the voice announcement. Then, any PS user can respond by pressing any dial key, and their reply will be heard by all of the called parties.

◆◆ **Join After Time Out**

Extensions or outside telephones can join the multiple party conversation that has been already started using this feature. For example, if the conference group members fail to answer when a conference group call is made, they can join the multiple party conversation later using this feature. They can join the conversation from outside telephones (through DISA or TIE Line) or extensions. This feature is available for both modes: Conference Mode and Broadcast Mode.

For security reasons, you can set a specific entry code for the conference group call. To join the conversation, extensions/outside telephones have to enter the same entry code. Therefore, you have to inform the parties to be added to the conversation of the entry code in advance.

#### ◆ For an extension originating the conversation

To make a conference group call with an entry code

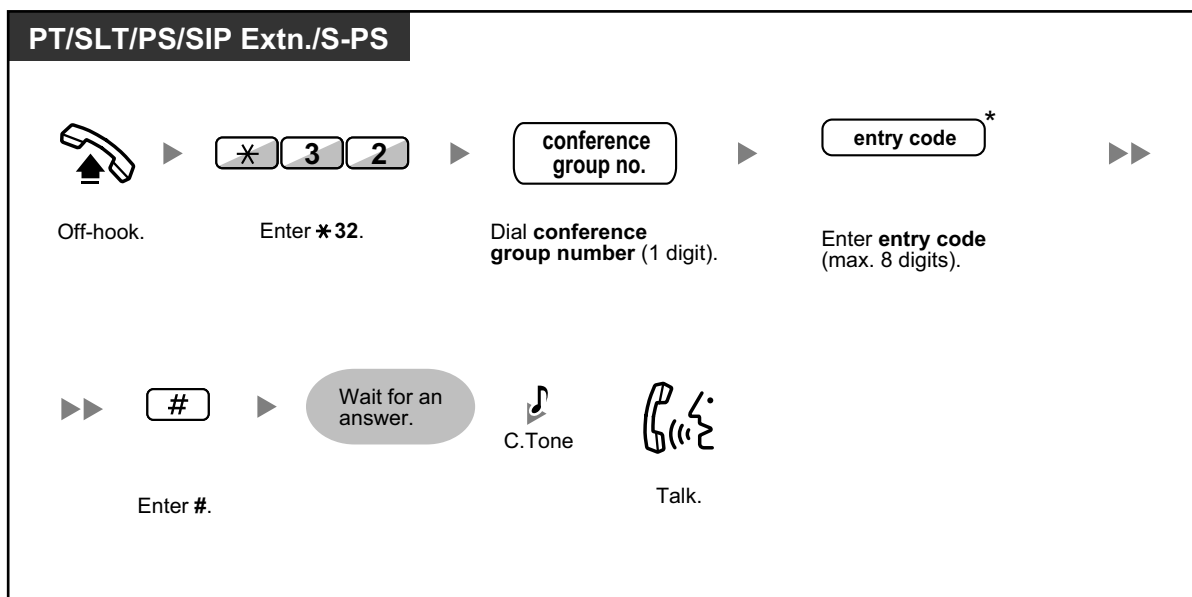

◆ For an extension joining the conversation

To join a conversation with an entry code

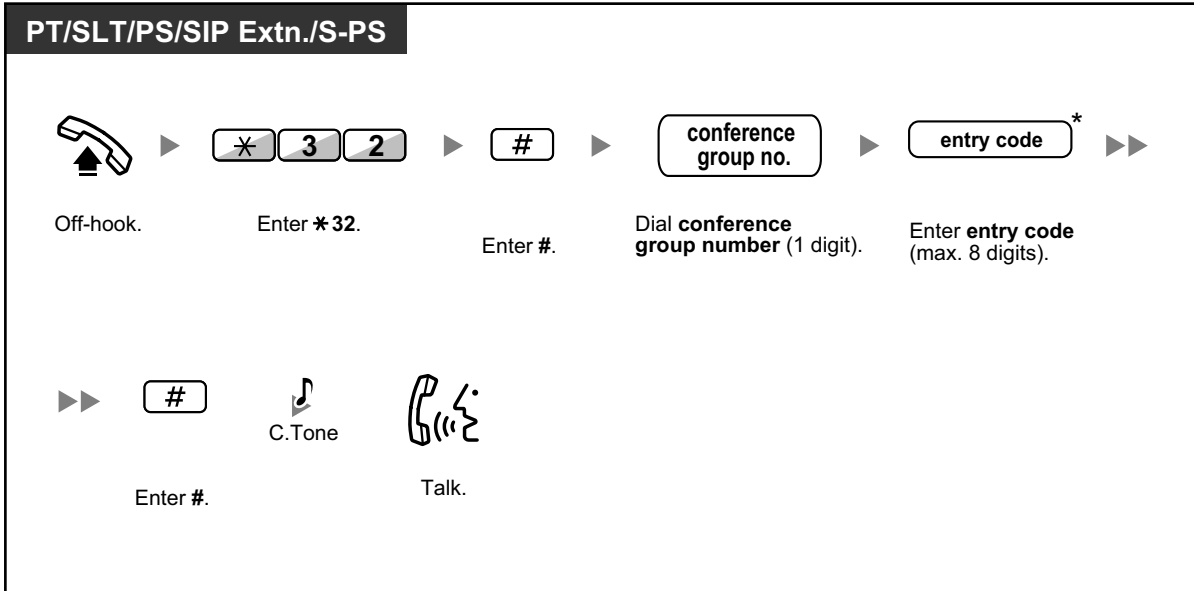

- \* If you do not enter an entry code when making the conference group call, extensions/outside telephones can join the conversation without needing to enter an entry code.
- Entry codes can consist of the digits "0" through "9". When "\*" is used for an entry code, no one can join a conversation that is already in progress.
- When you are using an outside telephone (through DISA or TIE Line), it is possible to join the conversation after accessing your extension using Walking COS.
- Extensions/outside telephones can join the conversation using this feature only when the conference group call has already been established between the extension originating a conversation and at least one member.
- To join a conversation that is already in progress, extensions/outside telephones must be using an idle extension with no held calls.
- If a conversation has reached the maximum number of participants, this feature cannot be used to join the conversation.



- **Starting a Conference Group Call using Hands-free Answerback**  
If the Hands-free Answerback feature is enabled with at least one conference group member, the call can be automatically answered and the conversation begins with only one participant (the caller). Then, up to 6 participants can use the Join After Time Out feature to join the conversation.



## 1.8 Using the Unified Messaging Features

### 1.8.1 What is the Unified Messaging system?

#### Introduction to the Unified Messaging system

Your PBX can provide you with Unified Messaging system service. You or an outside party can access the Unified Messaging system from a telephone. As the owner of a mailbox, you can:

- Send a message to one or more people inside or outside your office.
- Transfer messages to other subscribers and add your own comments.
- Access your mailbox and listen to your messages, even when out of the office.
- Have the Unified Messaging system call or e-mail you when someone leaves you a message.
- Be notified by the message waiting lamp on your extension when new messages have been recorded in your mailbox.
- Screen your calls.
- Create a set of options and functions exclusive to your mailbox (Personal Custom Service) that can be selected by your callers.
- Voice and e-mail messages can be managed in a single inbox using the Communication Assistant plug-in for Microsoft® Outlook®.
- Voice and e-mail messages can be managed via an e-mail client that supports IMAP4.
- Many other useful messaging features.



- PBX users who are assigned a mailbox in the Unified Messaging system are called subscribers.
- **Hospitality Mode:**  
If your service mode is set to "Hospitality Mode", available features such as listening to messages, personal greetings, etc. may be limited according to the COS settings for your mailbox.

#### Before You Begin

In order to use the Unified Messaging system as a subscriber, you need to know the following information. The System Manager can help you if you do not know this information.

- The extension number that you should dial in order to access the Unified Messaging system.
- Your mailbox number and extension number (In many cases these are the same number, but it is possible they are not).
- Your mailbox password (if set).
- The System Manager's telephone number. The System Manager is the person you should refer to when you have any problems with the Unified Messaging system.

#### Using the Unified Messaging system

There are two ways to use the Unified Messaging system; you can be either a subscriber, or a caller. Each subscriber has his or her own mailbox. Subscribers can play back voice messages, leave messages for other subscribers, record a message that is then sent to multiple parties (including outside parties), record greeting messages, etc. In order to use the Unified Messaging system as a subscriber, you must first "log in" to your mailbox. This usually involves dialing your mailbox number and entering your password. Once you have logged in, you can use "Subscriber Services"; Subscriber Services are all the features and functions you can access or perform as a subscriber.

A caller can generally be thought of as an outside party. Callers can leave messages for subscribers or use the Unified Messaging system to be connected to specific extensions, but they do not log in to the system before using these features, and the number of features they can use is limited.

## 1.8.1 What is the Unified Messaging system?

---

### Prompts

Prompts are recorded voice guidance messages that help you set and use Unified Messaging system features. Prompts also help callers when the system is handing their calls. Depending on how your Unified Messaging system is programmed, subscribers and callers can select the language they prefer for system prompts.

#### <Prompt example>

"To leave a message, press 1."

"Please leave a message at the tone."

"To end recording, hang up or press 1 for more features."



- Not all prompts are described in each operation.
- The prompts in each operation are not exactly the same as the actual prompts you will hear from the Unified Messaging system.
- Follow the instructions provided by the voice guidance.

## 1.8.2 Logging in to and Configuring Your Mailbox

- ◆◆ Logging in to Your Mailbox
- ◆◆ Subscriber Tutorial (Easy Mailbox Configuration)
- ◆◆ Changing or Deleting Your Personal Greeting Messages
- ◆◆ Personal Greetings for Caller ID
- ◆◆ Changing Your Password
- ◆◆ Changing or Deleting Your Subscriber (Owner) Name
- ◆◆ Common Service Commands and Navigation Commands

### Logging in to Your Mailbox for the First Time

The first time you log in to your mailbox, there are certain mailbox settings you should perform before using any other Subscriber Services. These settings identify you as the owner of your mailbox, and are described in "◆◆ Logging in to Your Mailbox".

- **Password**
- **Subscriber's Name**
- **Personal Greeting Messages**

Your Unified Messaging system may be programmed to initiate a "Subscriber Tutorial" the first time you log in to your mailbox. If the Subscriber Tutorial is enabled, Unified Messaging system prompts will guide you through the mailbox configuration process.

### ◆◆ Logging in to Your Mailbox

In order to access Subscriber Services (to play messages, change mailbox settings, etc.), you must first log in to your mailbox. There are 2 ways to log in to your mailbox:

#### Manual Log-in:

Manual Log-in is necessary when logging in to your mailbox using someone else's extension, or when Automatic Log-in is not enabled for your mailbox.

#### Automatic Log-in:

When logging in to your mailbox from your own extension, you do not need to enter any special commands or your mailbox number.



- The UM group's default floating extension number depends on system programming. For more information, consult your System Administrator or System Manager.



- **Mailbox Capacity Warning**  
When your mailbox is almost full, you will receive a Mailbox Capacity Warning shortly after logging in to your mailbox. When you hear a Mailbox Capacity Warning, you should delete unnecessary messages to make more recording time in your mailbox available. The amount of recording time that remains when you hear the Mailbox Capacity Warning depends on how your mailbox is configured. This feature may be disabled by the System Administrator or System Manager for your mailbox.  
For more information, consult your System Administrator or System Manager.
- **For KX-UT series SIP phone and S-PS users:**  
When using the MESSAGE button, please press the MESSAGE button before going off-hook.

### Manual log-in

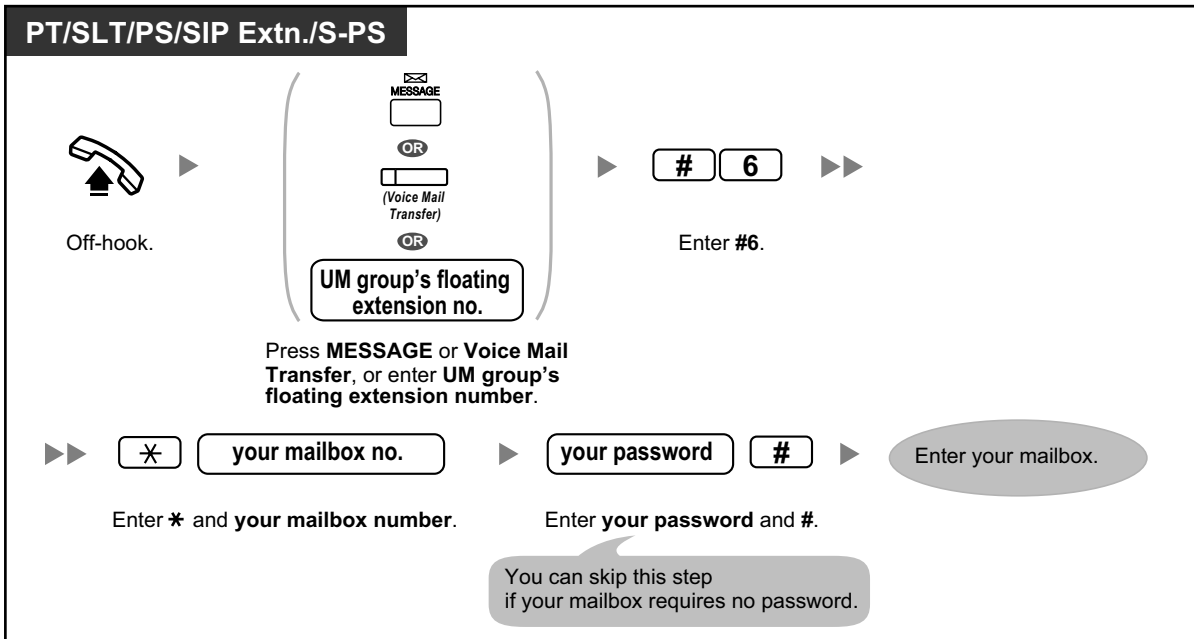

### Automatic log-in

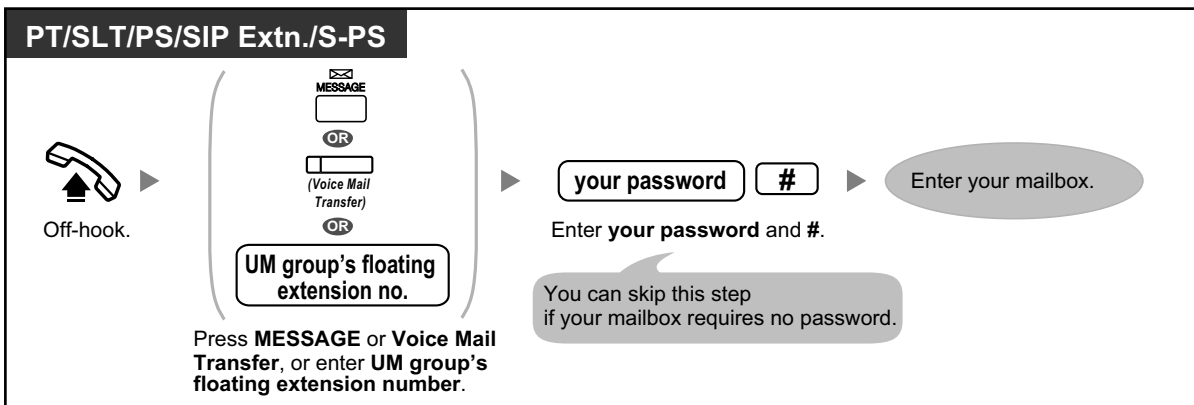

#### CAUTION

- It is strongly recommended that a password of 16 numbers be used for maximum protection against unauthorised access.
- To avoid unauthorised access to the PBX, keep the password secret. If it becomes known to others, the PBX may be misused.
- Change the password periodically.

#### Notice

- When disabling the password requirement, ensure that an unauthorised third-party is not allowed access to your extension.



- When following audible prompts only: if Autoplay New Messages is enabled for your mailbox, new messages will be played back automatically each time you log in to your mailbox. Whether or not new messages will be played back one after the other automatically depends on system programming. For more information, consult your System Administrator.
- If Message Waiting Lamp is enabled for your mailbox, the message lamp on your telephone will light when you receive a new message. You can log in to your mailbox and play back a new message automatically simply by going off-hook and pressing the Message button on your telephone. The Unified Messaging system will play back the first new message only. To play back other messages, press the appropriate button.
- After logging in, the system will announce the number of total messages, the number of new messages, or the length of new messages. These announcements depend on the mailbox settings and Class of Service (COS) settings of your mailbox.



### Customising Your Phone

- 3.1.3 Customising the Buttons  
Create or edit a Voice Mail Transfer button or a Message button.

## ◆◆ Subscriber Tutorial (Easy Mailbox Configuration)

Your Unified Messaging system may be programmed to present a "Subscriber Tutorial" to you the first time you log in to your mailbox. If the Subscriber Tutorial is enabled, Unified Messaging system prompts will guide you through the mailbox configuration process. Simply by following the prompts, you can configure the following items. You can configure these items later manually if necessary, as explained later in this section. This feature may be disabled by the System Administrator or System Manager for your mailbox.



- You may be asked to enter your password after logging in to your mailbox. If you do not know this password, ask your System Administrator.
- The subscriber tutorial may be simplified or not available depending on your COS settings.

### Password:

If your mailbox has a password, you must enter it using the dial keys (0–9) whenever you log in to your mailbox. Your password can contain up to 16 digits.

### Subscriber's Name:

This is a recording of your name. Other subscribers will hear your name when they listen to messages you left for them. It may also be heard by callers when they use the Dialling by Name feature.

### Personal Greetings:

The following Personal Greeting Messages can be recorded in the subscriber tutorial. After the greeting is played, a tone will sound, and the caller can leave a message.

- **No Answer Greeting:** Heard by callers when you do not answer their calls. A common example might be, "This is (name). I can't take your call right now...".
- **Busy Signal Greeting:** Heard by callers when you are on another call. A common example might be, "This is (name). I'm on another call right now...".
- **After Hours Greeting:** Heard by callers when the Unified Messaging system is in night mode. A common example might be, "This is (name). I've gone home for the day...".



- If you do not record a greeting message, a prerecorded greeting message will be used.

To start the Subscriber Tutorial

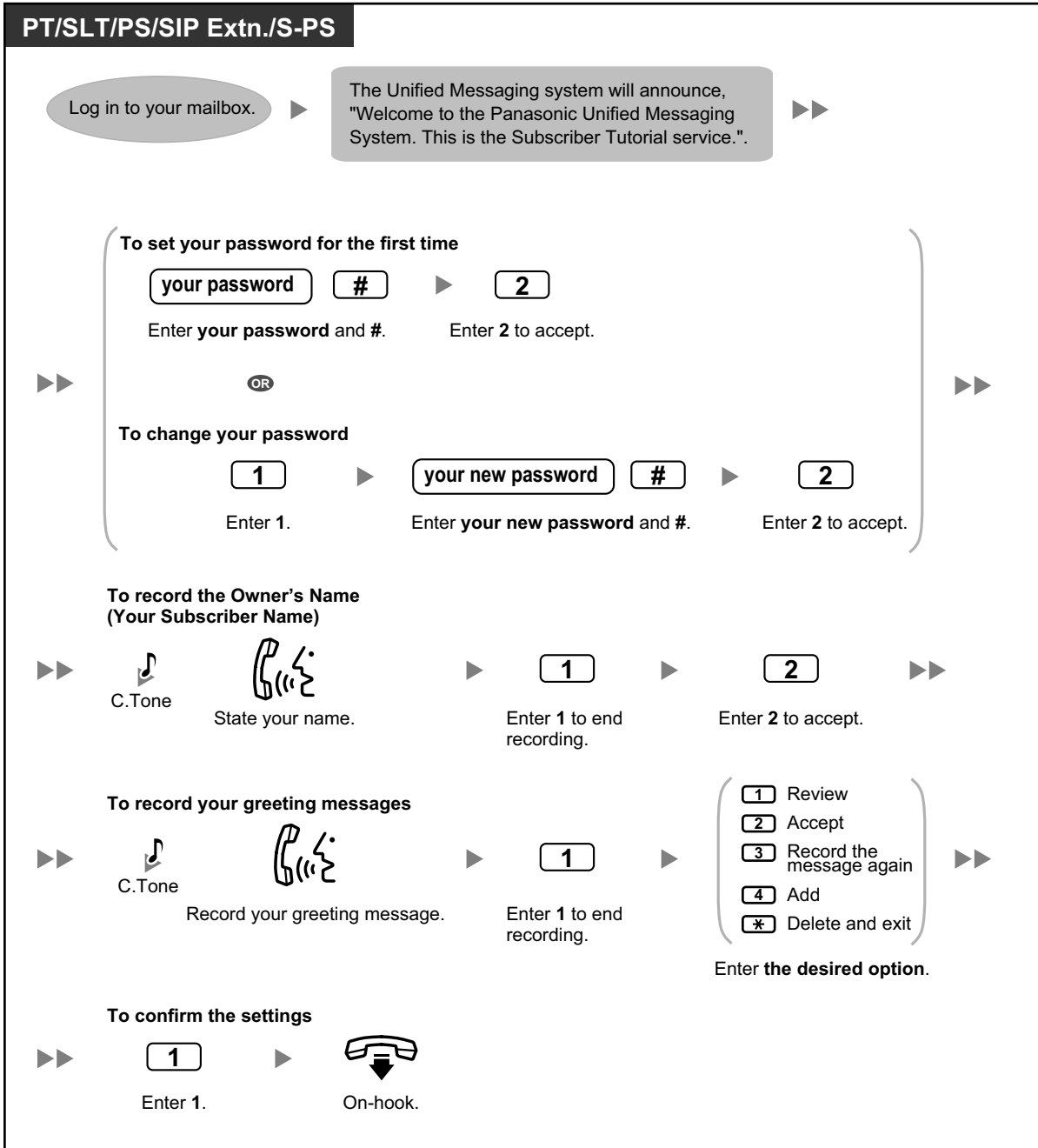

**CAUTION**

- It is strongly recommended that a password of 16 numbers be used for maximum protection against unauthorised access.
- To avoid unauthorised access to the PBX, keep the password secret. If it becomes known to others, the PBX may be misused.
- Change the password periodically.

## ◆◆ Changing or Deleting Your Personal Greeting Messages

After callers reach your mailbox, they will hear your personal greeting message. You can record 6 kinds of Personal Greetings; the appropriate greeting will be played for callers. If you delete or do not record a greeting message, a prerecorded greeting message will be used.

- **No Answer Greeting:**  
Heard by callers when you do not answer their calls. A common example might be, "This is (name). I can't take your call right now...".
- **Busy Signal Greeting:**  
Heard by callers when you are on another call. A common example might be, "This is (name). I'm on another call right now...".
- **After Hours Greeting:**  
Heard by callers when the Unified Messaging system is in night mode. A common example might be, "This is (name). I've gone home for the day...".
- **Personal Greeting for Caller ID:**  
Heard by callers from preprogrammed telephone numbers. For details, refer to "◆◆ Personal Greetings for Caller ID".
- **Temporary Greeting:**  
A special greeting that, if recorded, is heard by callers instead of the other greetings. A common example might be, "This is (name). I'm out of the office this week...".
- **Absent Message:**  
Heard by callers when a personal greeting is set to a PBX's absent message, and that absent message is currently set.

To record or delete your Personal Greeting Messages

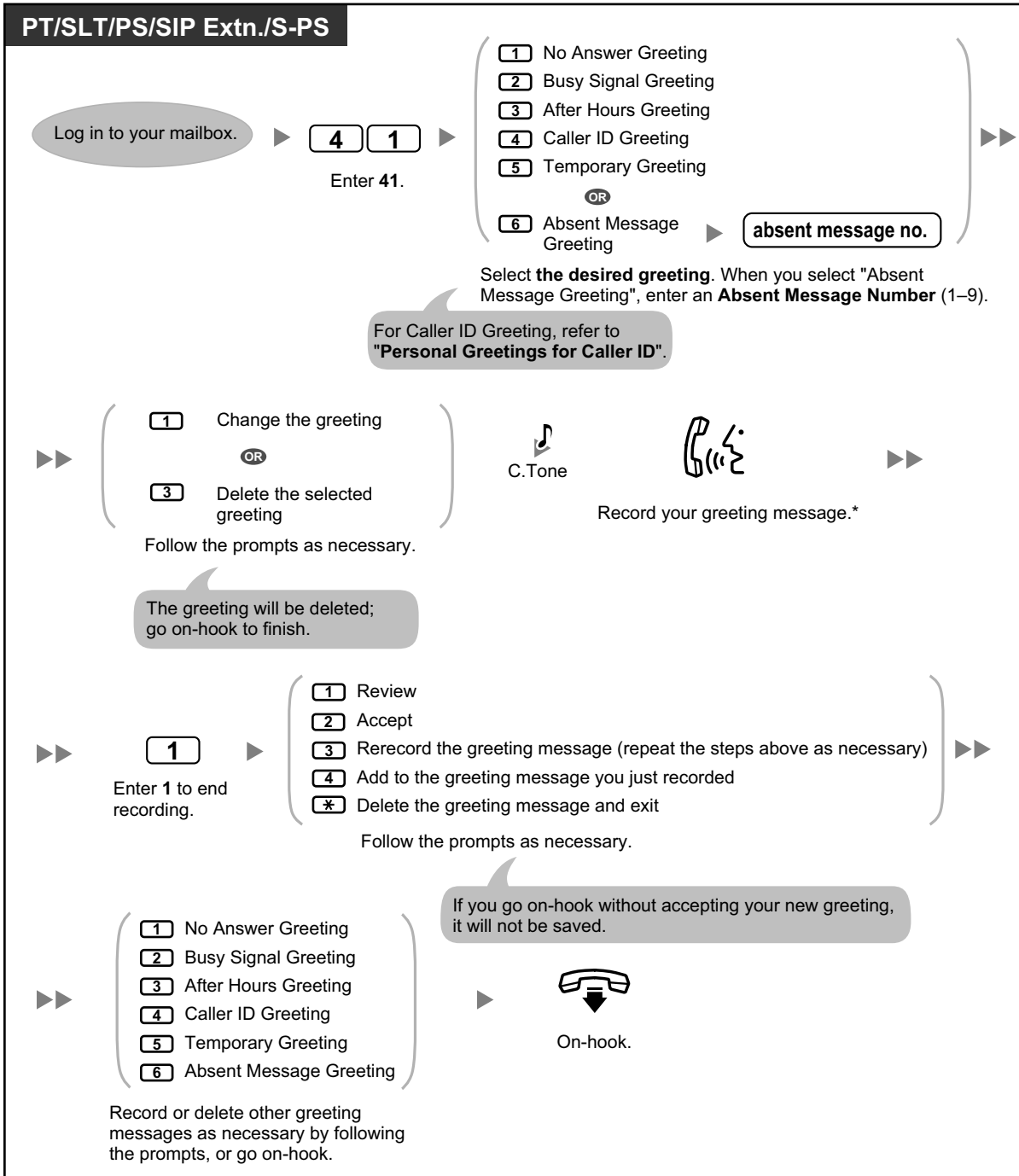

- The contents of the Absent Message Greeting prompt and the absent message displayed on telephones (refer to "1.6.2 Showing a Message on the Caller's Telephone Display (Absent Message)") should be programmed to match through system programming.





- \* We recommend stating your name in your greeting messages, so that callers will know they have reached the correct mailbox.
- A Temporary Personal Greeting is played instead of all your other greetings until it is deleted. Each time you log in to your mailbox, the Unified Messaging system will ask you if you want to turn off (delete) your Temporary Personal Greeting.
- **Direct Service Access**  
If Direct Service Access is set in Mailbox Settings, you can access Record No Answer Greeting, Record Busy Greeting, Record After Hours Greeting and Record Temporary Greeting features directly by dialling a specific Unified Messaging extension number from your extension. Automatic login must be enabled to use Direct Service Access (refer to "Automatic log-in"). For details about these Unified Messaging extension numbers, consult your System Administrator.

## ◆◆ Personal Greetings for Caller ID

You can record personalised greetings for specific callers. If you have assigned their telephone numbers (Caller ID numbers) to a personalised greeting, they will hear the appropriate greeting when they call you, instead of your other greeting messages normally played for callers. You can record 4 personalised greetings and assign 8 callers to each greeting. Record your personalised greetings before assigning Caller ID numbers. This feature may be disabled by the System Administrator or System Manager for your mailbox.

### To record a personalised greeting for the first time

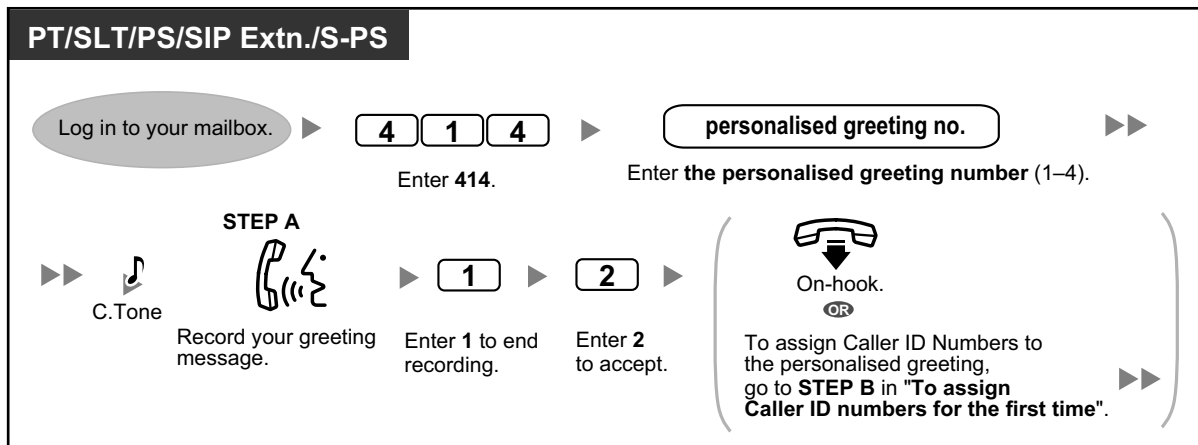

### To change a personalised greeting

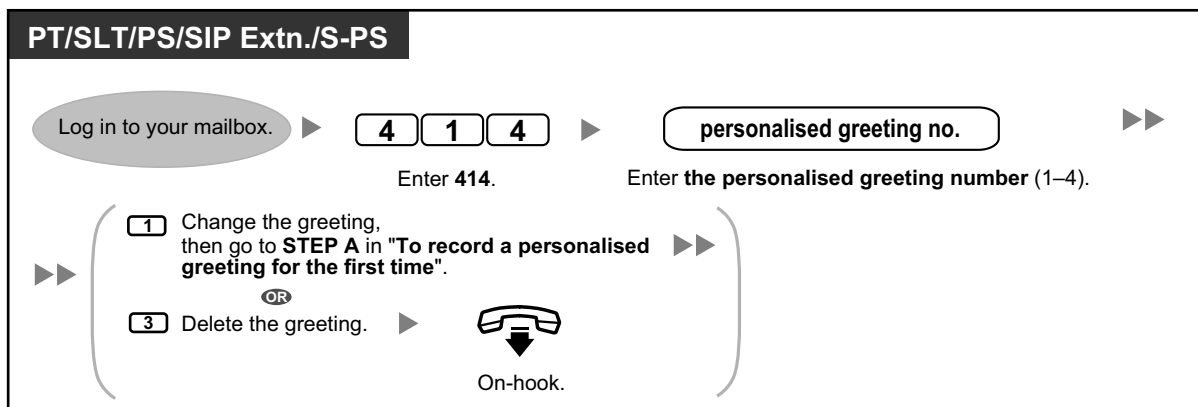

**To assign Caller ID numbers for the first time**

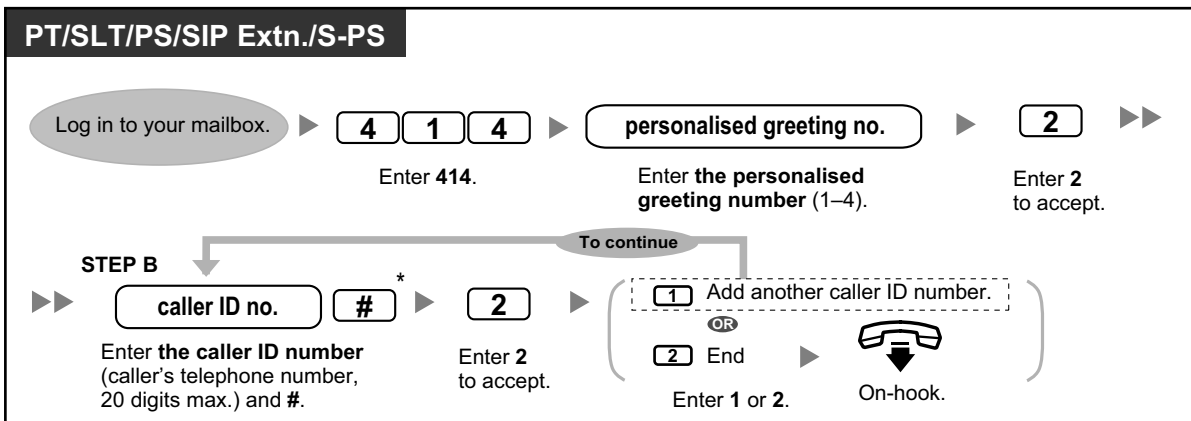

- \* While entering a Caller ID number, you can press \* to enter a "wild card". This allows several telephone numbers to match the Caller ID number that you assigned. For example, if you store the Caller ID number as "012\*...\*" (enter the number of \*s as required for telephone numbers in your area), any telephone number that begins with "012" (for example, all callers from the "012" area code) will hear your personalised greeting.

**To add/delete/review Caller ID numbers later**

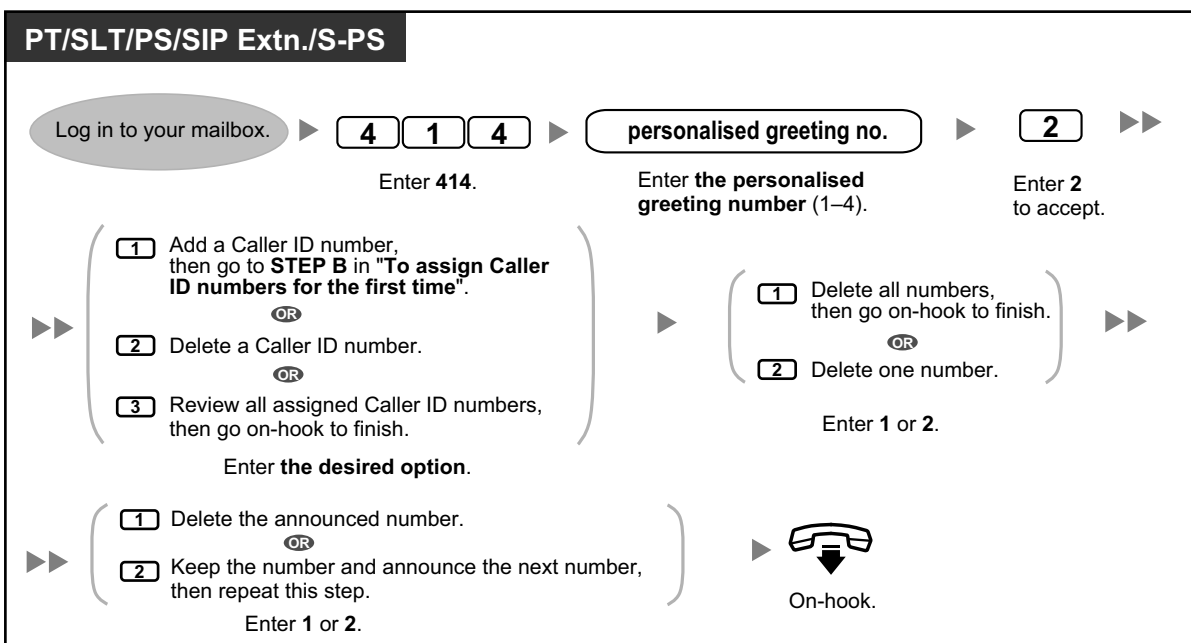

**◆◆ Changing Your Password**

You can password protect your mailbox to prevent unauthorised access to your mailbox. If your mailbox has a password, you must enter it using the dial keys (0–9) whenever you log in to your mailbox. Your password can contain up to 16 digits. You can change your password at any time. When choosing a password, avoid using obvious number combinations. If you forget your password, have your System Administrator or System Manager clear your password. You may then set a new one.

### To change your password

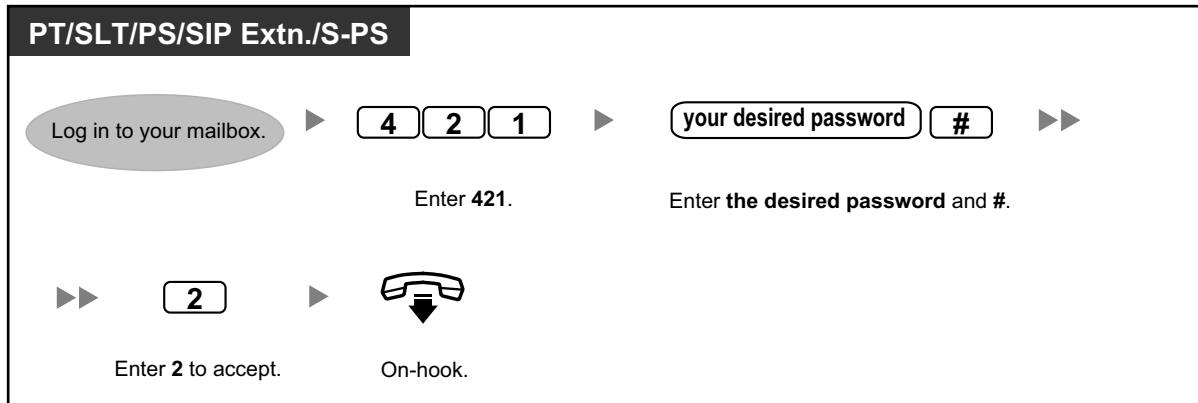

### CAUTION

- It is strongly recommended that a password of 16 numbers be used for maximum protection against unauthorised access.
- To avoid unauthorised access to the PBX, keep the password secret. If it becomes known to others, the PBX may be misused.
- Change the password periodically.

## ◆◆ Changing or Deleting Your Subscriber (Owner) Name

You can record your name in the Unified Messaging system. The system can then announce your name for callers to let them know that they have reached the correct mailbox. If a caller does not know your mailbox number, the caller can try to reach you by entering the first few letters of your first or last name (Dialling by Name feature). After entering the first few letters of your name, the Unified Messaging system will announce the names of Unified Messaging system subscribers whose names share those letters, and the caller can select your name.

### To change/delete your subscriber name

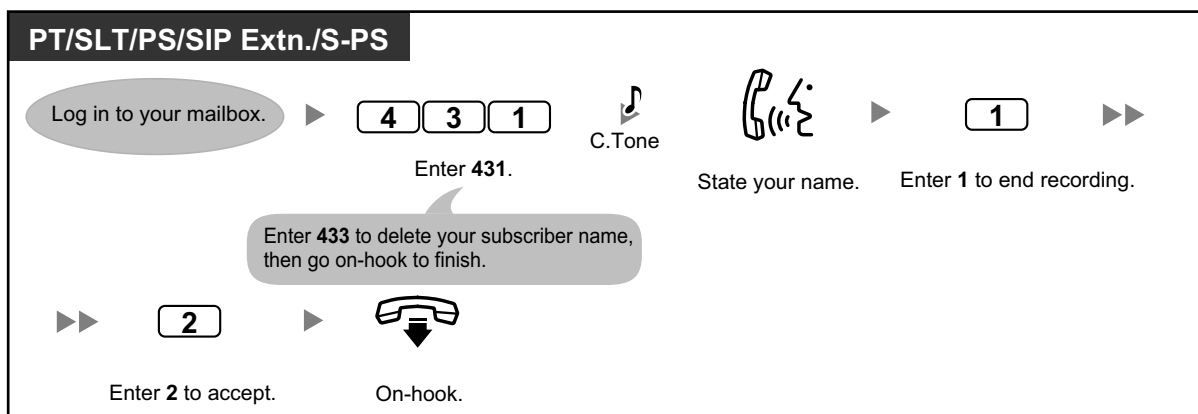

## ◆◆ Common Service Commands and Navigation Commands

### Commands for Changing the Current Unified Messaging System Service

After going off-hook and pressing the MESSAGE button<sup>1</sup>, Voice Mail Transfer button, or enter the UM group's floating extension number, you can enter a service command to access certain Unified Messaging

## 1.8.2 Logging in to and Configuring Your Mailbox

system features quickly. While guidance is being provided, you can also use service commands to, for example, switch to a different Unified Messaging system service mode.

<sup>\*1</sup> For KX-UT series SIP phone and S-PS users: When using the MESSAGE button, please press the MESSAGE button before going off-hook.

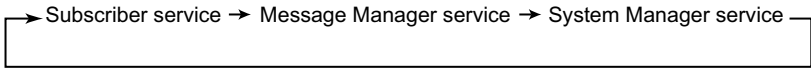
# 1	Dialling by Name
# 2	Custom Service You will be guided to enter a Custom Service number (1–200).
# 5	Log in <sup>*1</sup>
# 6	Voice Mail Service You can record a message for another subscriber by entering his or her mailbox number when guided. You can also log in to your mailbox by entering this command followed by * and your mailbox number.
# 7	Restart (Return to Main Menu) <sup>*2</sup>
# 8	Automated Attendant Service
# 9	Exit
*	Return to Previous Menu
0	Help
# #	Switch Service mode If you are authorised to access a System Manager and/or Message Manager mailbox by the System Administrator, you can switch between those services as follows:  

<sup>\*1</sup> If pressed while in Subscriber Service, you will be prompted to enter the desired mailbox number.

<sup>\*2</sup> If pressed while in Subscriber Service, you will return to the Subscriber Service Main Menu.



- Commands #5 and #7 are available only after you have accessed Subscriber Service.
- Some commands may not be available depending on the COS settings of your mailbox.

### When Using Voice Prompts

The following commands can be used to help you navigate through Unified Messaging system menus.

*	Takes you back to the previous menu.
0	Repeats the current menu.
# 7	Takes you back to the Main Menu.

## 1.8.3 Message Playback and Related Features

- ◆◆ Playing Messages
- ◆◆ Bookmarks (Voice Messages only)
- ◆◆ Recovering Deleted Messages
- ◆◆ Replying to Messages
- ◆◆ Transferring Messages
- ◆◆ Remote Access

### ◆◆ Playing Messages

Callers and other subscribers can leave voice messages for you, and you can play them back later after you have logged in to your mailbox.

Messages in your mailbox are divided into 3 types:

- **New Messages:**  
Messages in your mailbox which you have not played back yet.
- **Old Messages:**  
Messages in your mailbox which you have played back but have not yet deleted.
- **Deleted Messages:**  
Messages in your mailbox which you have deleted. You can "recover" your deleted messages, after which they will be treated as old messages (refer to "◆◆ Recovering Deleted Messages"). If you do not recover deleted messages, they will be permanently deleted at the end of the day.

When playing back a message, the Unified Messaging system can also announce the message's "envelope"—the date and time of the message, and the message sender's information.

#### To play messages

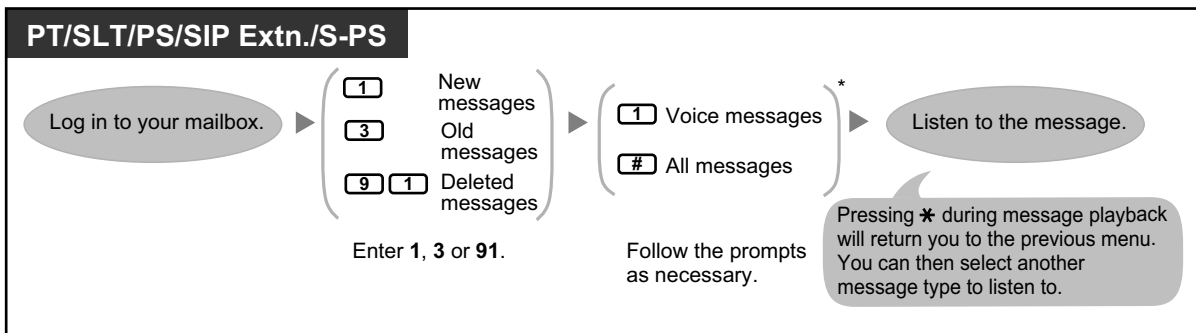

- \* This step is omitted depending on settings and COS settings of your mailbox.

Additional features are available during/after the playback of voice messages. Refer to the table below and press the appropriate dialling key. The message types that can be used with each key are marked with a ✓. Note that certain features are not available depending on the message type (new, old, deleted).

Key	Feature	Message Type		
		New	Old	Deleted
[1]	Repeat this message	✓	✓	✓

### 1.8.3 Message Playback and Related Features

Key	Feature	Message Type		
		New	Old	Deleted
<b>1</b> <b>1</b>	Replay the previous message	✓	✓	✓
<b>2</b>	Play the next message	✓	✓	✓
<b>3</b> (+ <b>1</b> *)	Delete this message • If a confirmation message is played, press <b>1</b> to delete the message.	✓	✓	
<b>3</b>	Recover this message			✓
<b>4</b>	Reply to this message	✓	✓	
<b>5</b>	Transfer this message	✓	✓	
<b>6</b> *	Play the message envelope	✓	✓	✓
<b>7</b>	<During playback only> Rewind the voice message	✓	✓	✓
<b>8</b>	<During playback only> Pause/restart message playback	✓	✓	✓
<b>8</b> <b>4</b>	<During playback only> Increase playback volume	✓	✓	✓
<b>8</b> <b>5</b>	<During voice message playback only> Set a Bookmark for the voice message • To restart message playback, press <b>8</b> .	✓	✓	
<b>8</b> <b>6</b>	<For voice messages only> Start playback at the Bookmark for the voice message	✓	✓	
<b>9</b>	<During playback only> Fast-forward	✓	✓	✓
<b>#</b>	Save this message as new • After saving the message, the next message will be played.	✓		

\*1 These keys only available when the appropriate COS settings are assigned to your mailbox. For more information, consult your System Administrator.



- For voice messages, Unified Messaging system programming determines if the message envelope is played before each message, after each message, or only when you press **6**. For more information, consult your System Administrator.
- The Unified Messaging system will automatically delete both new and old messages after a specified number of days have passed. Your System Administrator or System Manager controls how many days messages are retained for. Each time you play a new or old message, the message retention counter resets.
- During playback, you can increase the playback volume by pressing **84**. If volume is at the highest setting, pressing **84** will select the lowest setting, as shown below.

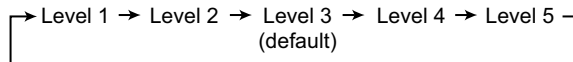

### ◆◆ Bookmarks (Voice Messages only)

While listening to a message in your mailbox, you can set a bookmark. A bookmark lets you easily resume playback from a specific point in a specific message later. You can set one bookmark for each message in your mailbox; if you set a new bookmark, the old one is deleted.



- You cannot set or use bookmarks for deleted messages.

#### To set the Bookmark

**PT/SLT/PS/SIP Extn./S-PS**

*During message playback*

Enter **85**.

#### To start playback at the Bookmark

**PT/SLT/PS/SIP Extn./S-PS**

*During or after message playback*

Enter **86**.

### ◆◆ Recovering Deleted Messages

You can delete voice messages in your mailbox. Once a message has been deleted, it is retained until the end of the day, then it will be permanently deleted. Deleted messages can be "recovered", after which they will be treated as old messages.

### To recover a Deleted Message

**PT/SLT/PS/SIP Extn./S-PS**

*During or after voice message playback*

**3**

Enter 3.

### ◆◆ Replying to Messages

You can reply to messages left in your mailbox by either calling back the caller or by leaving a message in the caller's mailbox.

Calling back is possible when the person who left you the message is another subscriber. Calling back outside callers is possible if their Caller ID information is received by the system, however, this feature may be disabled by the System Administrator or System Manager for your mailbox.

Replying by leaving a message in the caller's mailbox is possible only if the caller is another subscriber (i.e., the person must have his or her own mailbox). When replying by leaving a message in the caller's mailbox, you can set any of the following:

- **Urgent Status:**  
The message will be heard before other messages by the recipient.
- **Private Status:**  
The recipient will not be able to forward the message, ensuring privacy.
- **Auto Receipt:**  
You will receive notification (receipt message) once the recipient has played back the message.

Finally, you can send your reply immediately or set a message delivery time. However, please note that you cannot reply to receipt messages.



- Only new and old messages can be replied to. To reply to a deleted message, recover the message first (refer to "◆◆ Recovering Deleted Messages").

### To call back the message sender

**PT/SLT/PS/SIP Extn./S-PS**

*During or after voice message playback*

**4**      ▶      **1**

Enter 4.                      Enter 1 to call the sender.



## To leave a message for the sender

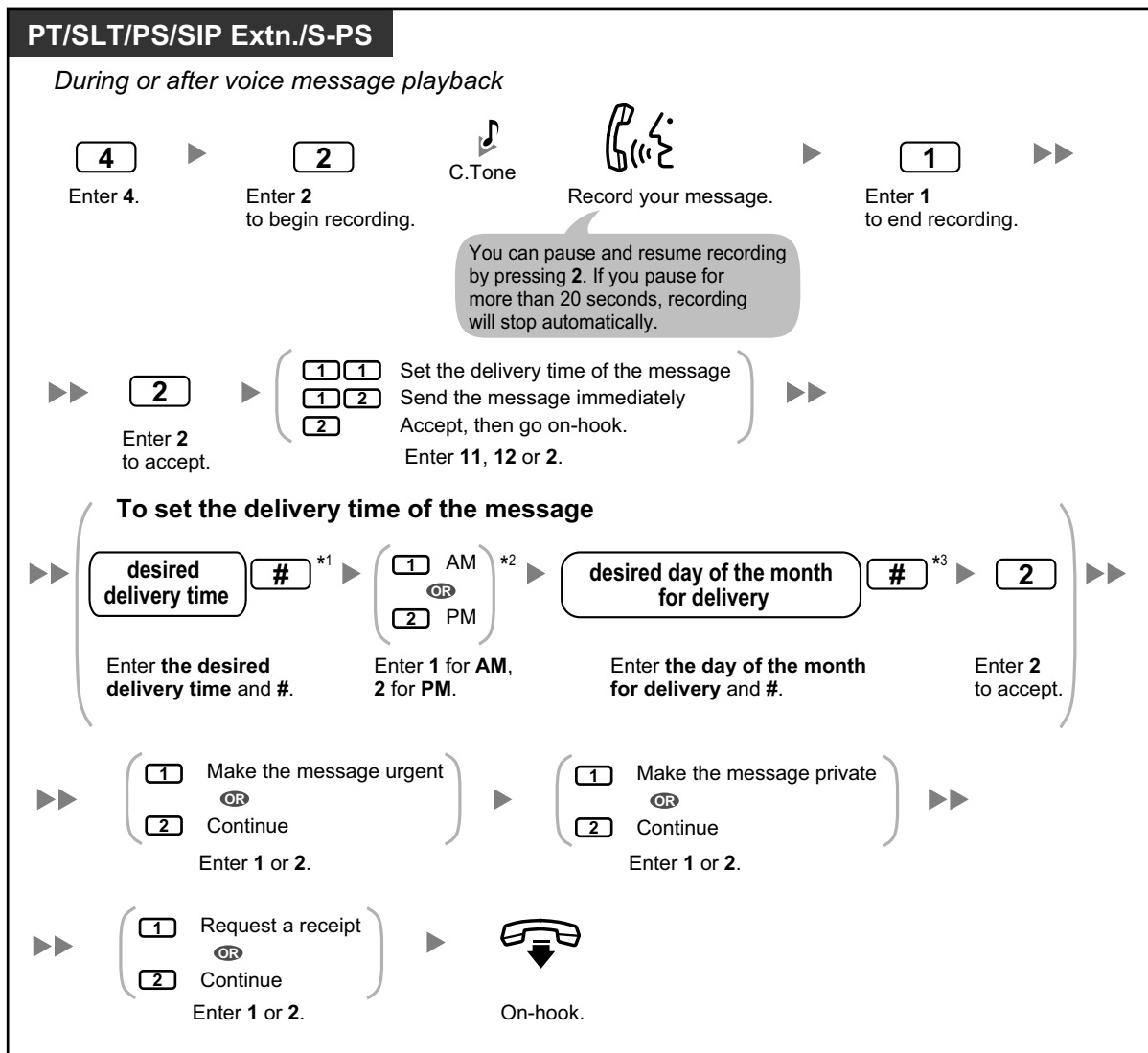

- \*1 Example: To enter 5:00, press **5#**. To enter 5:15, press **515#**.
- \*2 This option may not be available if the Unified Messaging system is programmed to use 24-hour time.
- \*3 Example: If today is February 16 and you enter **17#**, the message will be delivered tomorrow. If today is February 16 and you enter **5#**, the message will be delivered on March 5.
- Auto Receipt is not enabled by default. For more information, consult your System Administrator.
- New urgent messages are played before any other messages. However, old urgent messages are treated like regular messages: messages are played starting with the oldest.

## ◆◆ Transferring Messages

You can transfer (forward) messages in your mailbox to other subscribers. However, please note that you cannot transfer receipt messages, or messages that were specified by the sender as "private".

When transferring a message, you can:

- Specify the recipient by entering another subscriber's mailbox number.

### 1.8.3 Message Playback and Related Features

- Specify several recipients by entering a Personal Group Distribution List number (refer to "◆◆ Personal Group Distribution Lists") or a Mailbox Group number.
- Record your own comments and send them along with the transferred message.



- No acknowledgement will be given to indicate the message has been transferred.
- Only new and old messages can be transferred. To transfer a deleted message, recover the message first (refer to "◆◆ Recovering Deleted Messages").

#### To specify the recipients by number

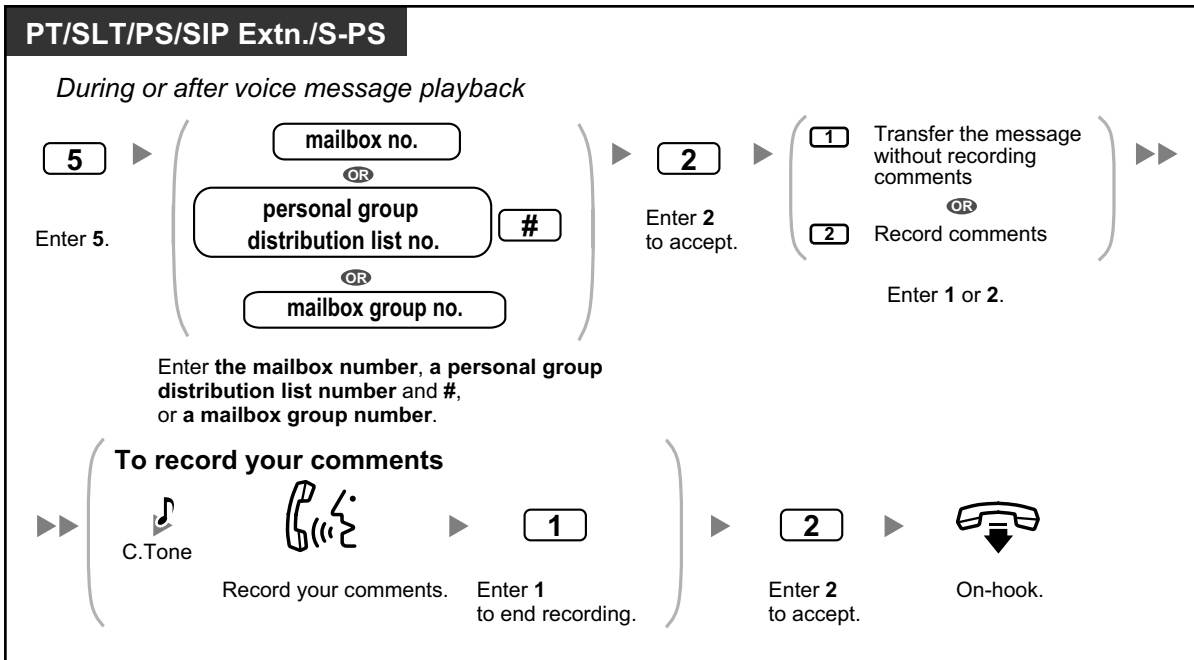

#### To specify the recipients by name (dialling by name)

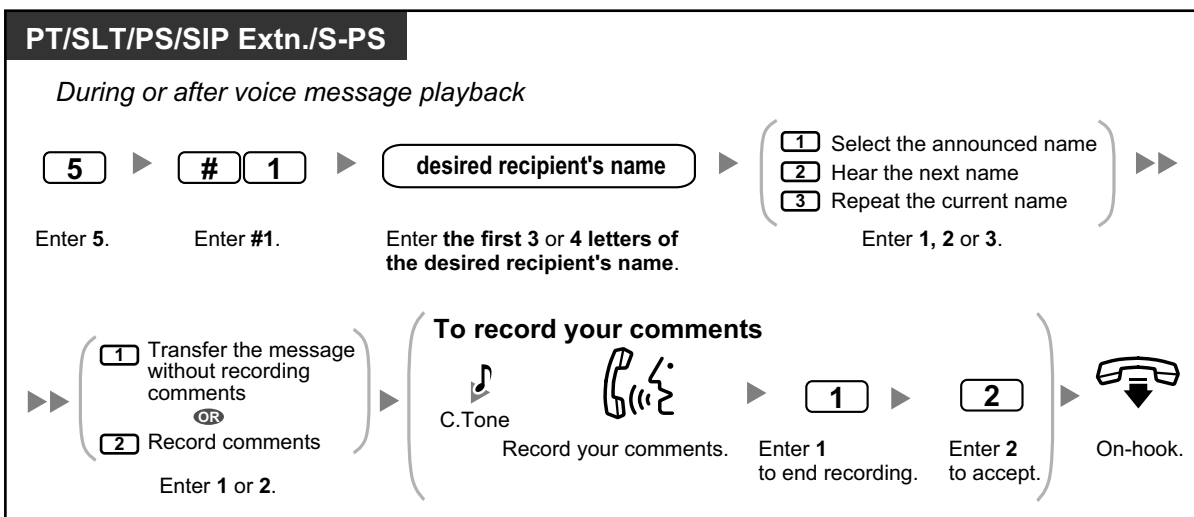

## ◆◆ Remote Access

You can call the Unified Messaging system while outside and log in to your mailbox in order to listen to your messages. There are 2 ways to log in to your mailbox remotely:

- **Automatic Log-in:**

When logging in to your mailbox remotely from a preprogrammed outside telephone number (assigned as a Caller ID number), you do not need to enter any special commands or your mailbox number. The Unified Messaging system can recognise the telephone number you are calling from and therefore determine you are the caller (refer to "◆◆ Assigning Your Telephone Numbers for Remote Automatic Log-in and Toll Saver"). This feature may be disabled by the System Administrator for your mailbox.

- **Manual Log-in:**

Manual Log-in is necessary if logging in to your mailbox, when your mailbox is not programmed for Automatic Log-in, or when you are calling from a telephone number not programmed for Automatic Log-in.



- Ask your System Administrator what telephone number you should dial in order to access the Unified Messaging system remotely.

### Remote automatic log-in

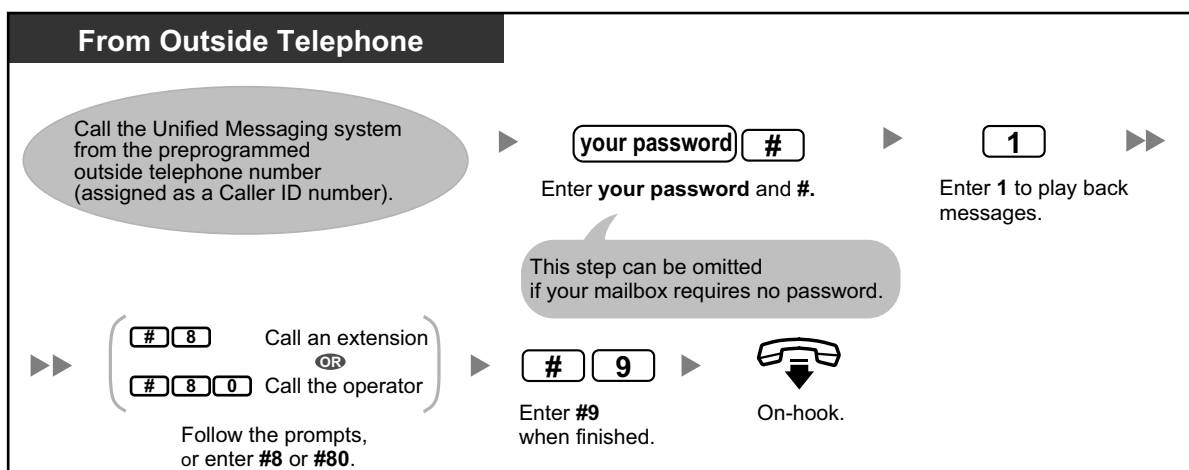

- The number of rings you hear before the Unified Messaging system answers your call can indicate whether or not you have new messages (Toll Saver feature). For more information, consult your System Administrator.

### Remote manual log-in

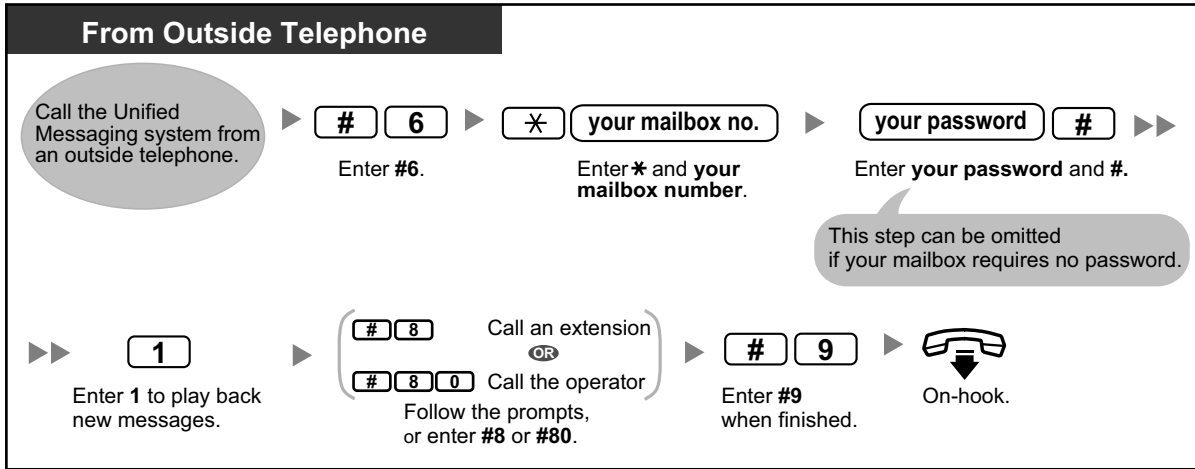

#### **CAUTION**

- It is strongly recommended that a password of 16 numbers be used for maximum protection against unauthorised access.
- To avoid unauthorised access to the PBX, keep the password secret. If it becomes known to others, the PBX may be misused.
- Change the password periodically.

#### **Notice**

- When disabling the password requirement, ensure that an unauthorised third-party is not allowed access to your extension.

## 1.8.4 Sending Messages

- ◆◆ Message Delivery
- ◆◆ Personal Group Distribution Lists
- ◆◆ External Message Delivery
- ◆◆ External Message Delivery Lists
- ◆◆ Receiving External Delivery Messages

You can record messages and send them to other subscribers, to extension users who do not have mailboxes, and even to outside parties. Messages can be sent using one of the following features:

- **Message Delivery:**  
Sending a message to other subscribers (refer to "◆◆ Message Delivery").
- **External Message Delivery:**  
Sending a message to parties that do not have Unified Messaging system mailboxes (extension users and outside parties) (refer to "◆◆ External Message Delivery").

There are several ways to determine the recipients of your messages. You can specify recipients by:

- Mailbox number or subscriber name (specifies an individual recipient for Message Delivery).
- Personal Group Distribution List number or Mailbox Group number (specifies a group of recipients for Message Delivery).
- Extension number or telephone number (specifies an individual recipient for External Message Delivery).
- External Message Delivery List number (specifies a group of recipients for External Message Delivery).

### ◆◆ Message Delivery

You can send messages to other subscribers. You can specify message recipients either by number or by subscriber name.

To specify the recipients by number:

- Enter the subscriber's mailbox number.
- Enter a Personal Group Distribution List number (refer to "◆◆ Personal Group Distribution Lists").
- Enter a Mailbox Group number (these must be created by the System Administrator. For more information, consult your System Administrator).

To specify the recipients by name:

- Enter the first few letters of the subscriber's name (Dialling by Name feature).

Once you have specified the recipients, you can record a message. Before sending your message, you can set any of the following:

- **Urgent Status:**  
The message will be heard before other messages by the recipient.
- **Private Status:**  
The recipient will not be able to forward the message, ensuring privacy.
- **Auto Receipt:**  
You will receive notification once the recipient has played back the message.

Finally, you can send your message immediately or set a message delivery time.

### To send a message

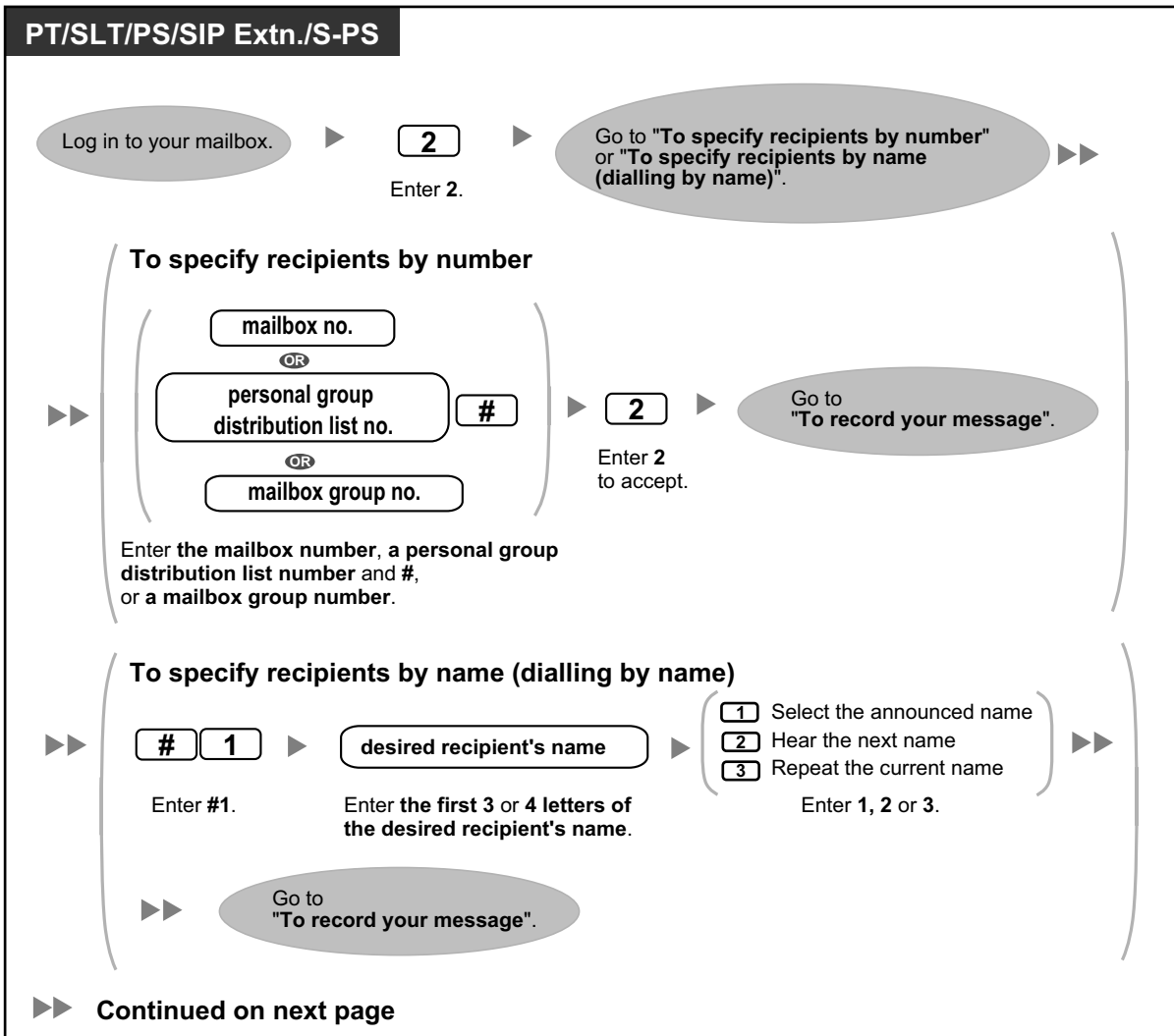

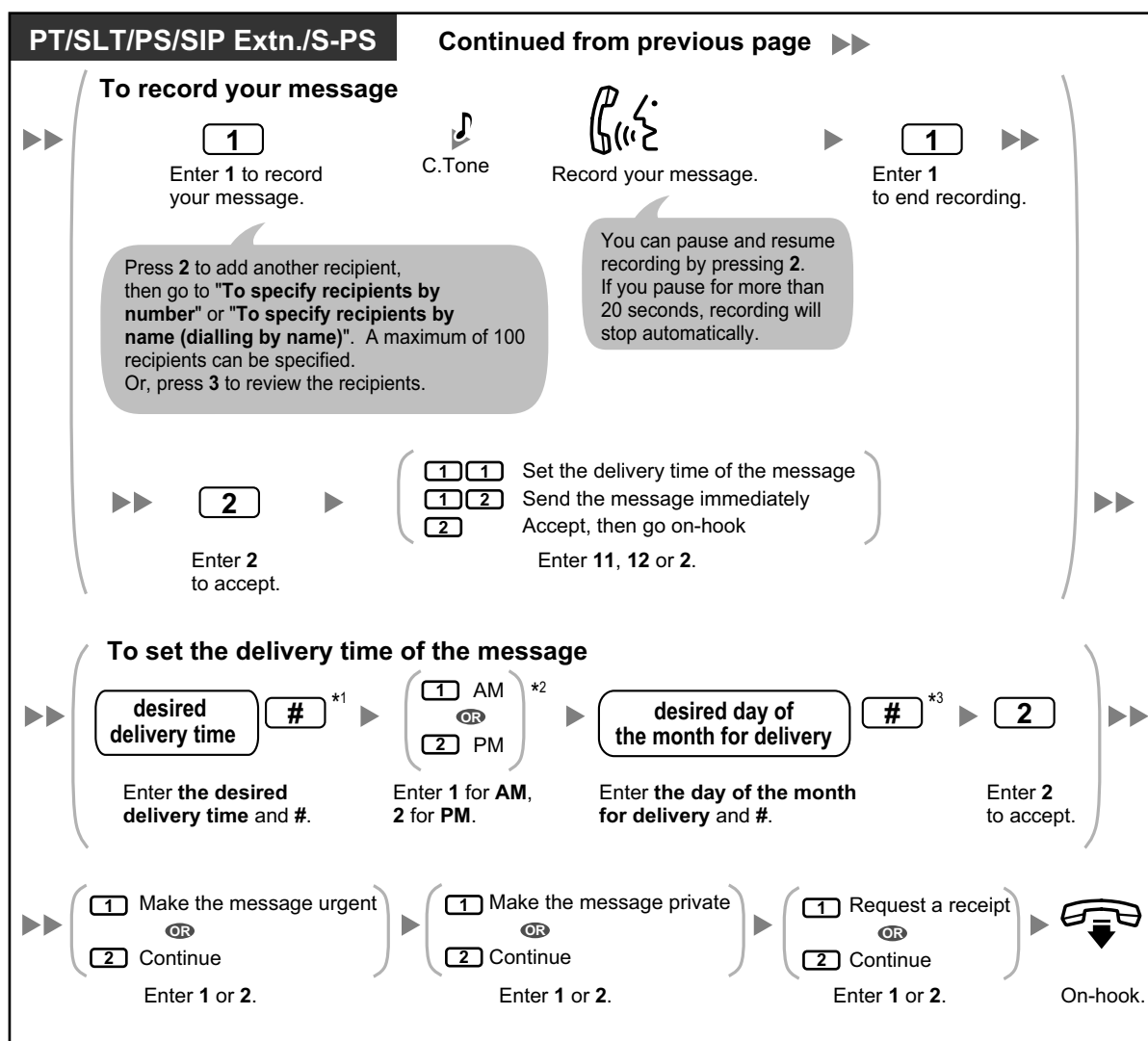

- \*1 Example: To enter 5:00, press **5#**. To enter 5:15, press **515#**.
- \*2 This option may not be available if the system is programmed to use 24-hour time.
- \*3 Example: If today is February 16 and you enter **17#**, the message will be delivered tomorrow. If today is February 16 and you enter **5#**, the message will be delivered on March 5.
- Auto Receipt is not enabled by default. For more information, consult your System Administrator.
- New urgent messages are played before any other messages. However, old urgent messages are played with other messages, in the original order.

## ◆◆ Personal Group Distribution Lists

Personal Group Distribution Lists allow you to send messages to several subscribers at once (refer to "◆◆ Message Delivery"). You can create and edit 4 Personal Group Distribution Lists, and these lists can only be used by you. You can assign 40 group members (subscribers) to each list and record a name for each group (for example, "Sales Team", "Department Heads", etc.).

**To create and edit personal group distribution lists**

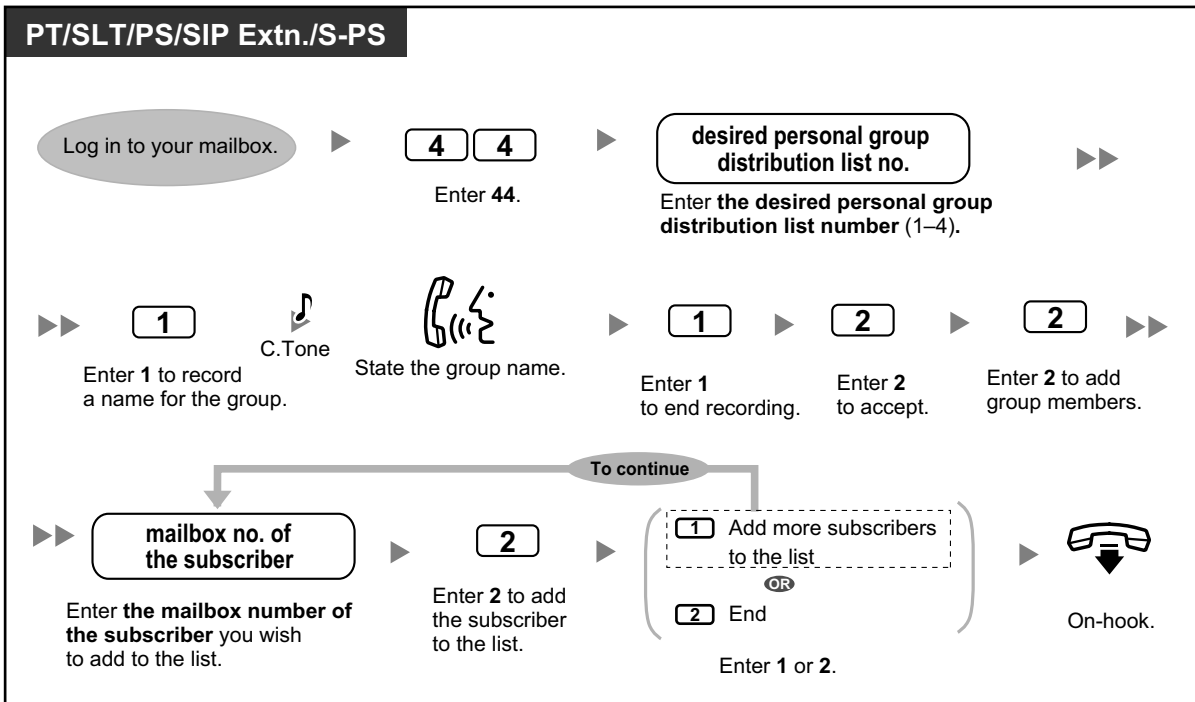

**To delete members from personal group distribution lists**

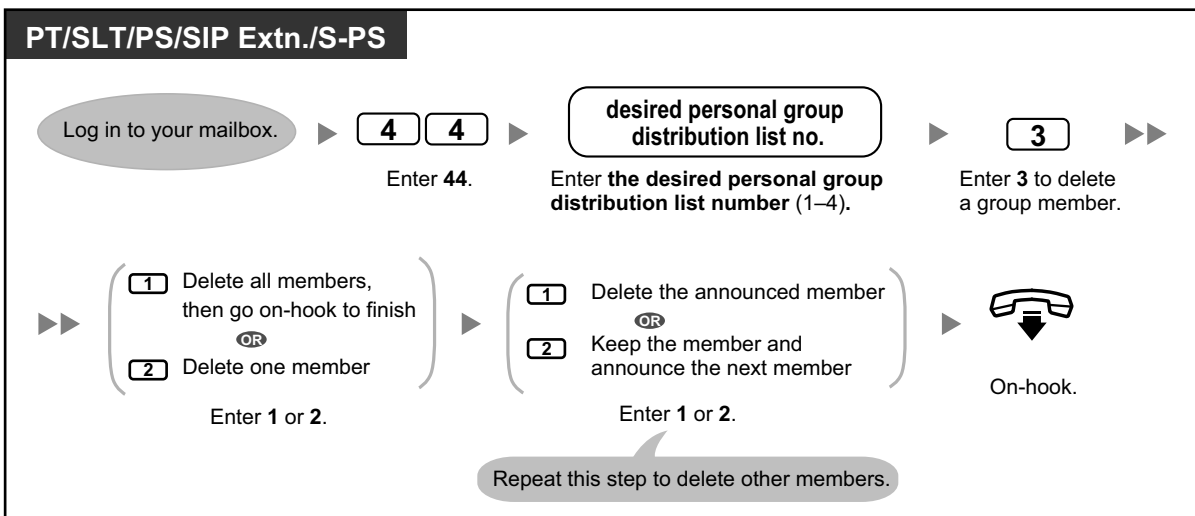



## To change personal group distribution list names

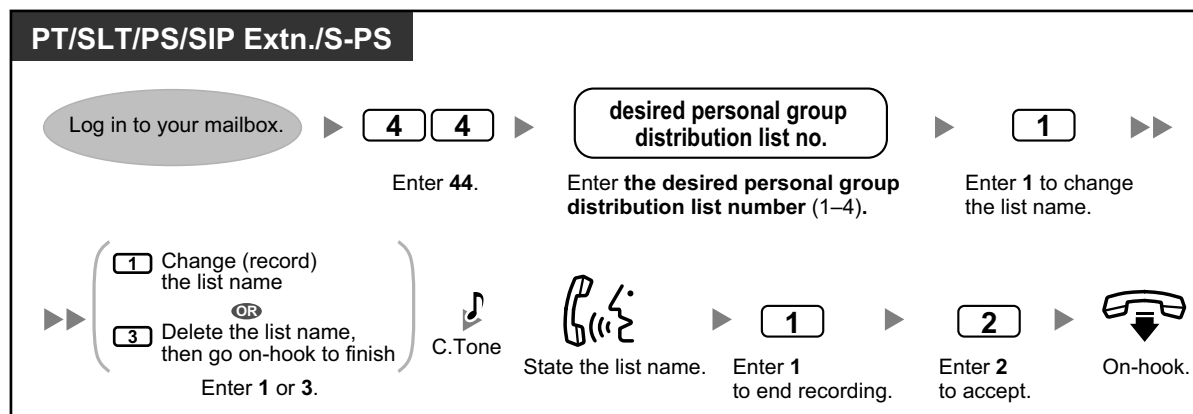

- The System Administrator can create "Mailbox Groups", which are similar to personal group distribution lists except they can be used by other subscribers. For more information, consult your System Administrator.

## ◆◆ External Message Delivery

You can send messages to outside parties and to extension users who do not have their own mailboxes. After you record your message, the system will dial the appropriate telephone numbers and/or extension numbers, and once the party on the other end answers the call, your recorded message will be played back. You can specify message recipients by:

- Extension number
- Outside telephone number
- External Message Delivery List number (refer to "◆◆ External Message Delivery Lists")

Unlike recipients who have their own mailboxes, you have no way of knowing who may answer the call when the Unified Messaging system sends an External Delivery Message. To protect the privacy of your messages, you may assign a password that must be entered by the other party before your message is played back. You can set Auto Receipt so that you will receive notification once the recipient has played back your message. You can also send your message immediately or set a message delivery time. Finally, recipients of an External Delivery Message can reply to your message, and can even set urgent and private message status.



- This feature must be enabled for your mailbox by the System Administrator or System Manager.

To send an external delivery message

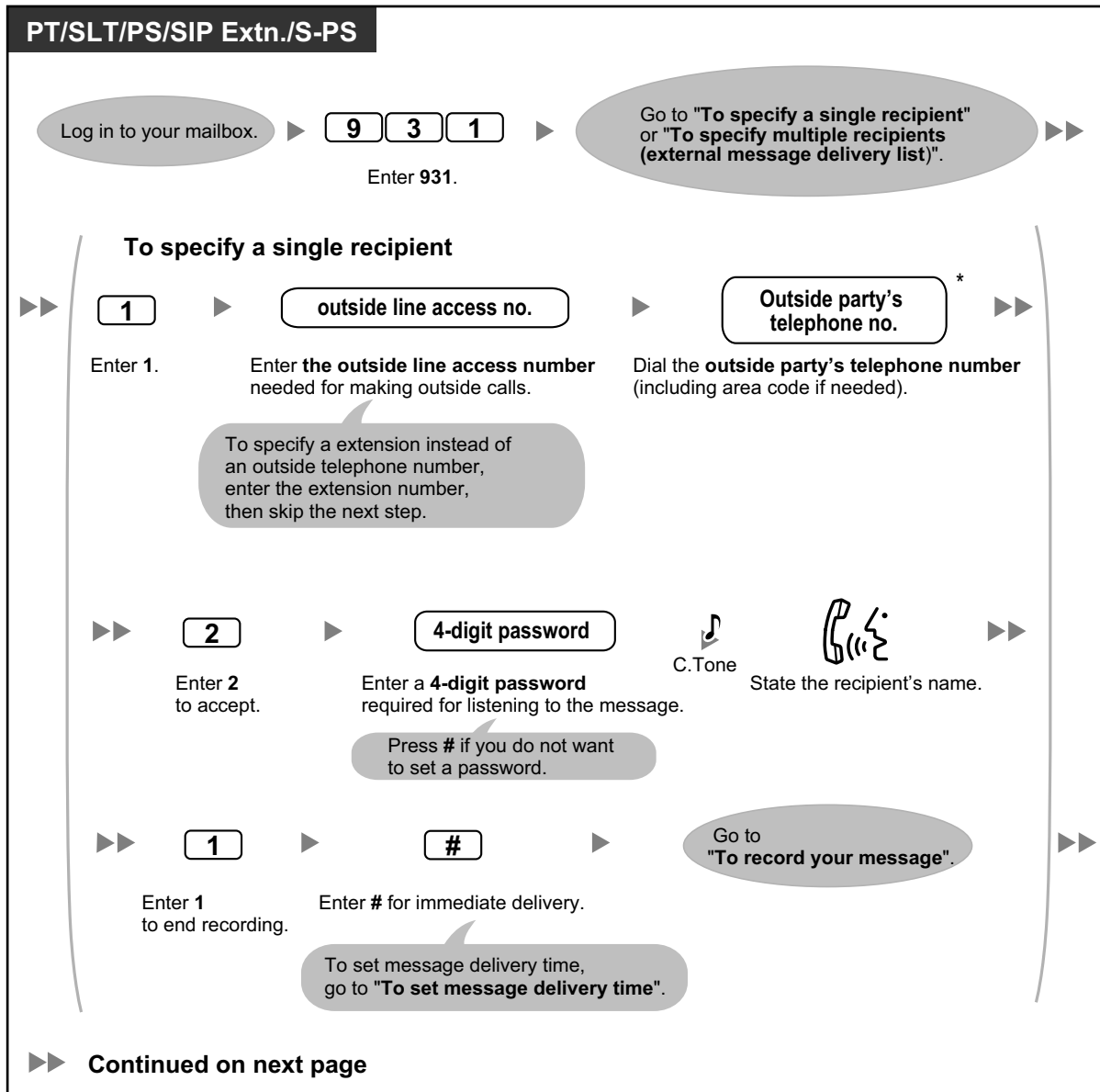

- \* If you are using an ISDN or SIP line in en bloc dialling mode, to insert a pause or special command in the middle of the telephone number, pause momentarily while entering the telephone number. You will hear a list of available options, for example, "To add more digits, press 4. To insert a pause, press 5."

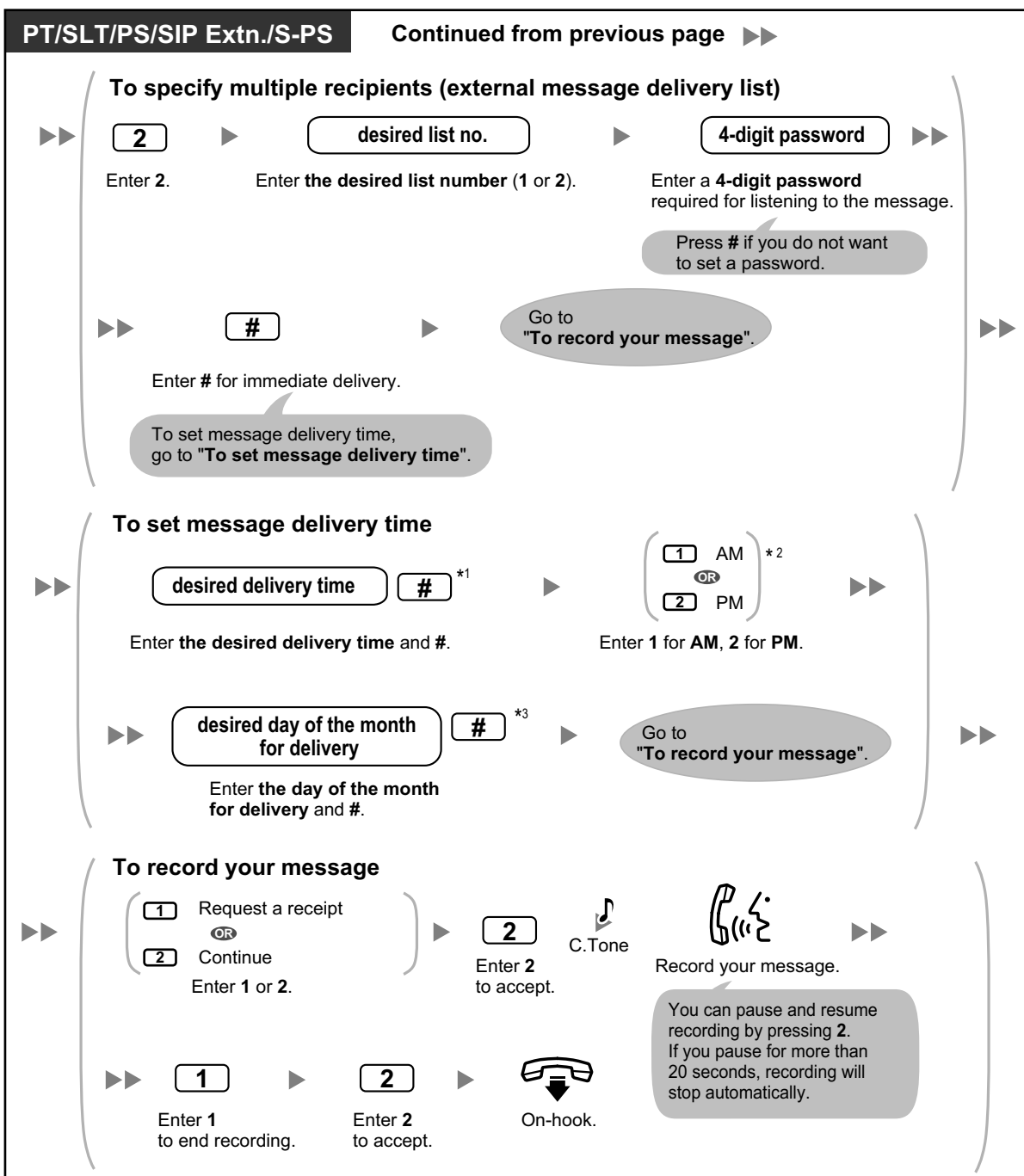

## 1.8.4 Sending Messages

---



- \*1 Example: To enter 5:00, press **5#**. To enter 5:15, press **515#**.
- \*2 This option may not be available if the system is programmed to use 24-hour time.
- \*3 Example: If today is February 16 and you enter **17#**, the message will be delivered tomorrow. If today is February 16 and you enter **5#**, the message will be delivered on March 5.
- If you set a password required for listening to the message, make sure you notify each recipient what the password is.
- If you are using a PRI line, you may need to enter # at the end of outside telephone numbers. For more information, consult your System Administrator.
- Auto Receipt is not enabled by default. For more information, consult your System Administrator.

### ◆◆ External Message Delivery Lists

Your external message delivery lists allow you to send messages to several outside parties and extension users who do not have their own mailboxes at once (refer to "◆◆ External Message Delivery"). You can create and edit 2 External Message Delivery Lists, and these lists can only be used by you. You can assign up to 8 members to each list and record a name for each member.



- This feature must be enabled for your mailbox by the System Administrator.

## To create/add to an external message delivery list

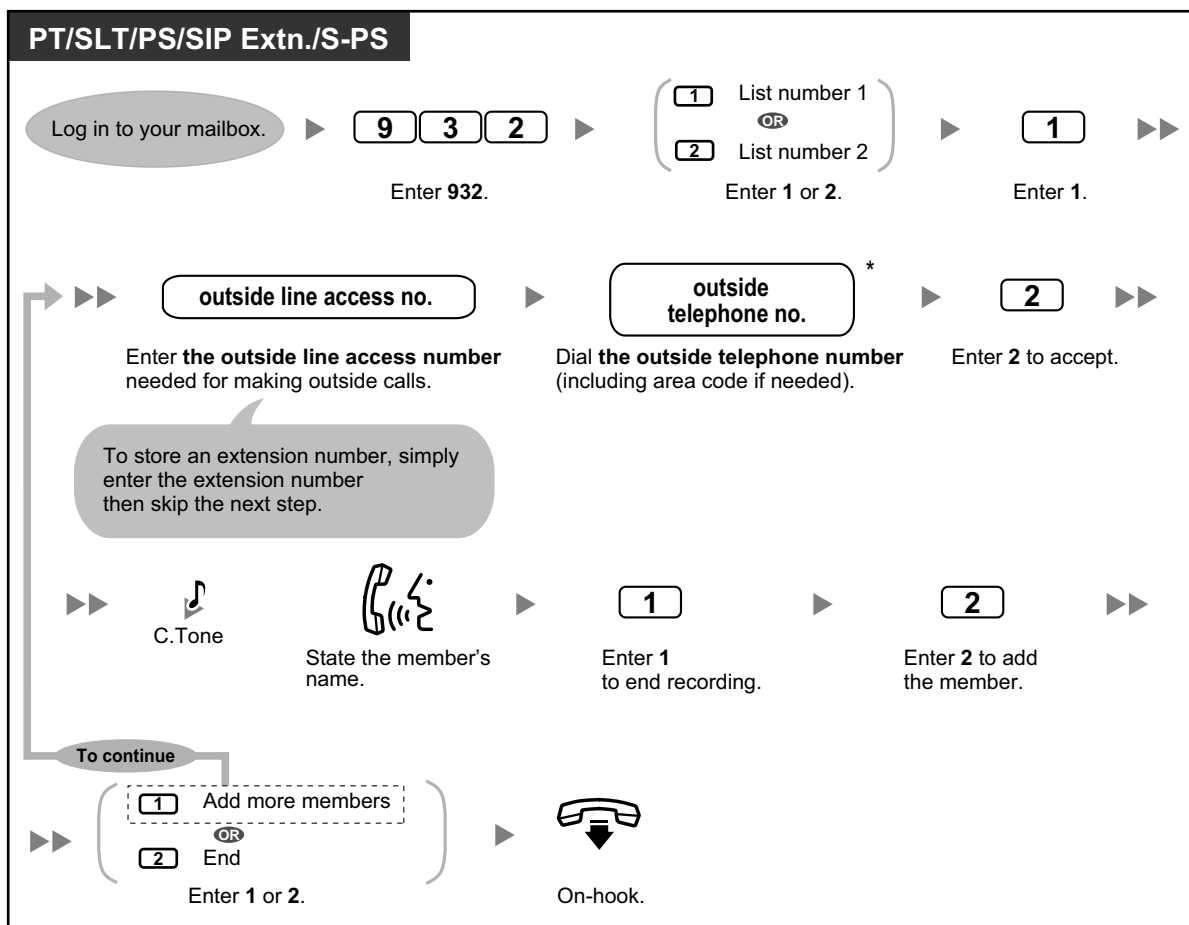

- \* If you are using an ISDN or SIP line in en bloc dialling mode, to insert a pause or special command in the middle of the telephone number, pause momentarily while entering the telephone number. You will hear a list of available options, for example, "To add more digits, press 4. To insert a pause, press 5."

## To delete members from an external message delivery list

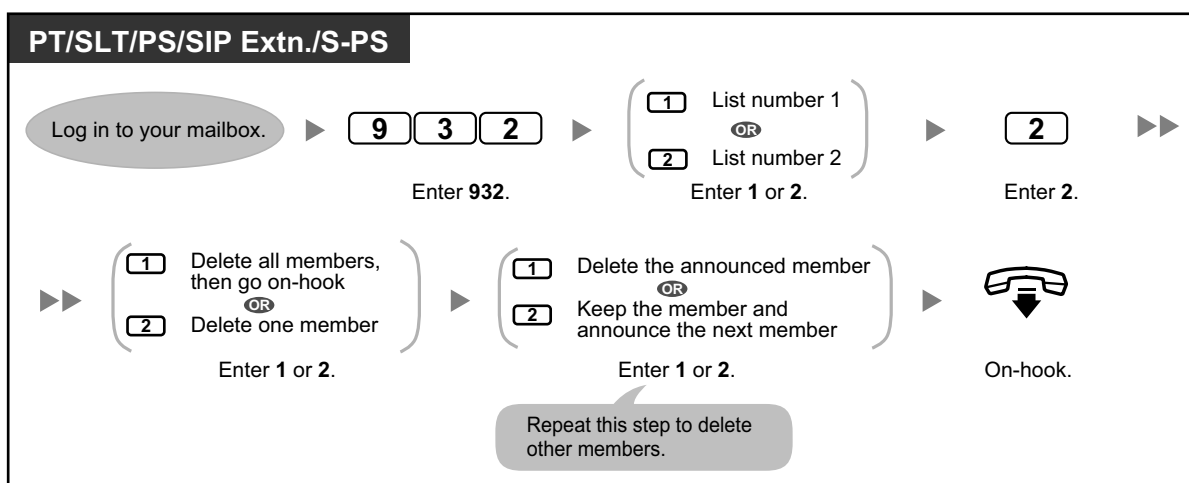

## ◆◆ Receiving External Delivery Messages

When you send an external delivery message, the Unified Messaging system will call each of the specified recipients. When a recipient answers the call, the system will guide him or her through the following procedure. After a recipient has listened to an external delivery message, he or she can send you a reply to your message, and even set urgent or private message status.

### To receive a message and reply

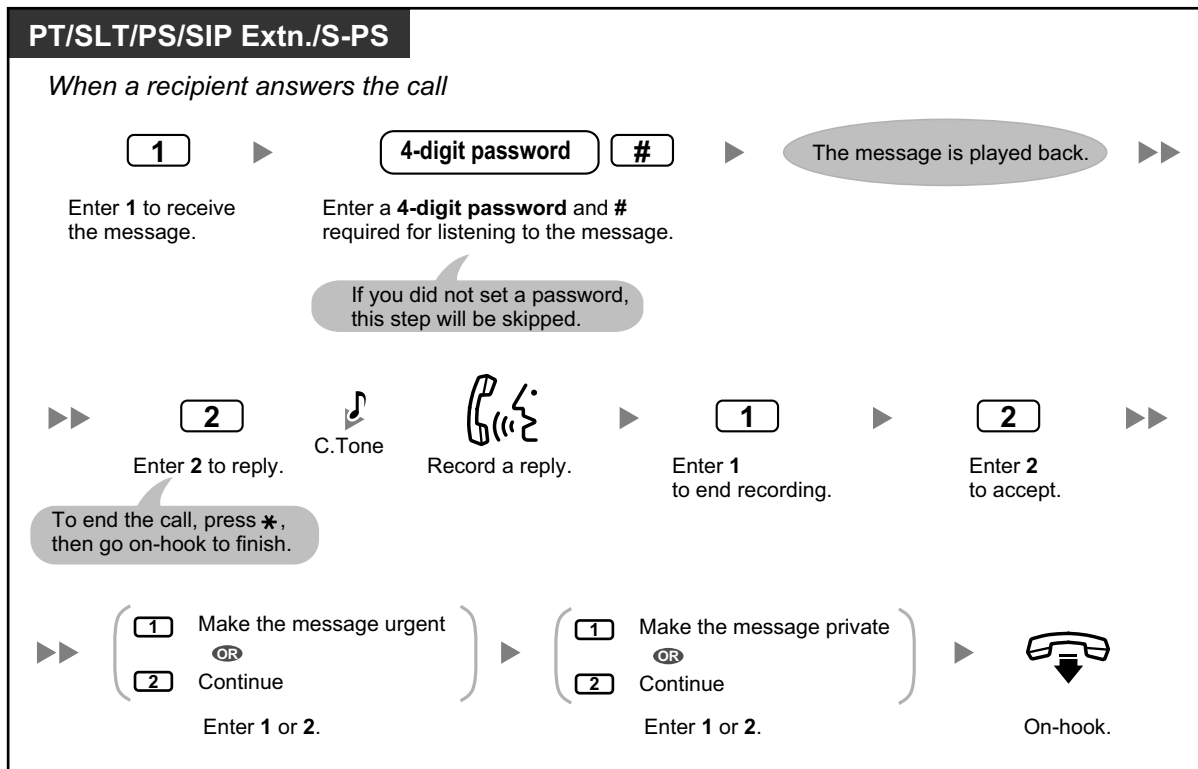

- If the recipient enters an incorrect password 3 times, the system will announce the following information if it has been programmed. This information can help the recipient track down the message or message sender (you).
  - Company name
  - Callback telephone number
  - Your subscriber name
- The Unified Messaging system may be able to guide recipients using a different language. For more information, consult your System Administrator.

## 1.8.5 Transferring Calls

- ◆◆ Call Transfer
- ◆◆ Incomplete Call Handling
- ◆◆ Assigning Your Covering Extension
- ◆◆ Remote Call Forwarding
- ◆◆ Assigning and Cancelling Telephone Numbers for Call Transfer to Outside Line
- ◆◆ Voice Mail Transfer

### ◆◆ Call Transfer

When a call reaches your extension via the Automated Attendant service, normally your extension will ring and you can answer the call. If you use the Call Transfer feature, however, the Unified Messaging system can handle the call in a number of ways. The status you set for Call Transfer determines what happens to the call. You can set one of the following:

#### **Call Blocking:**

The call will be handled by the Incomplete Call Handling feature (refer to "◆◆ Incomplete Call Handling"), which allows you to have your calls ring at another extension, transferred to your mailbox, transferred to the operator, etc. The call will not ring at your extension. The call will be handled according to the settings you have made for Incomplete Call Handling for No Answer.

#### **Call Screening:**

The system will prompt the caller to record his or her name. If you are available to answer calls, the system will ring your extension and play back the name of the caller. You can then answer the call if you choose. If you do not or cannot answer the call, the call will be handled according to the settings you have made for Incomplete Call Handling for No Answer.

#### **Intercom Paging:**

The Unified Messaging system will page you using the Intercom Paging feature. The call will not ring at your extension. Your name will be announced to alert you to the call. If you do not or cannot answer the call, the call will be handled according to the settings you have made for Incomplete Call Handling for No Answer.

#### **Transfer to Mailbox:**

The system will transfer the caller to your mailbox where he or she can leave a message for you. The call will not ring at your extension.

#### **Transfer to Custom Service:**

The system will transfer the caller to the custom service you specify here. The call will not ring at your extension.

#### **Disable Call Transfer:**

Turns the Call Transfer feature off. The call will ring at your extension.

To set call transfer status

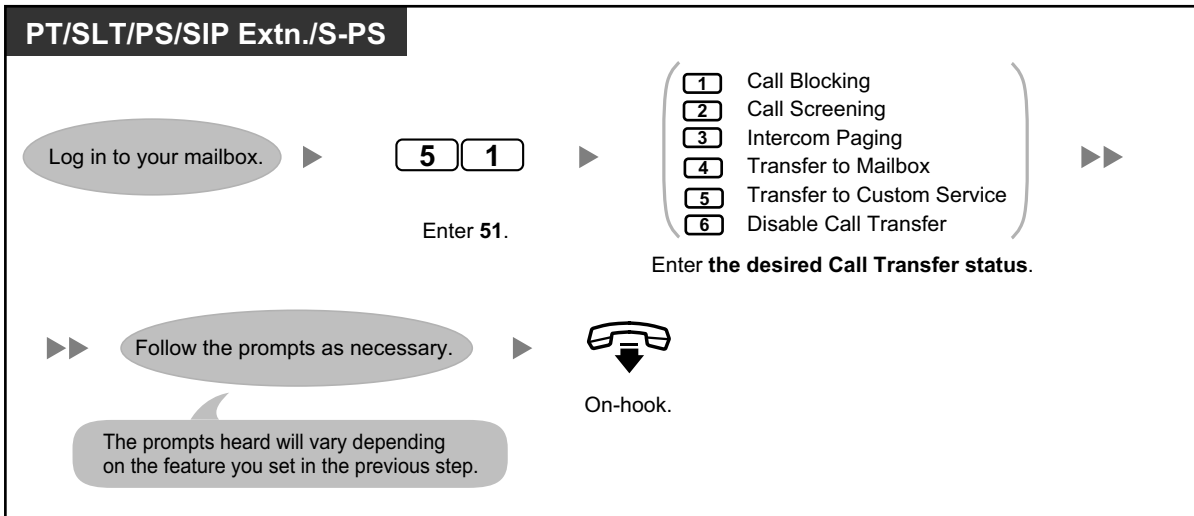

- If Call Screening or Disable is selected, calls will be transferred to an outside telephone if a telephone number has been programmed for call transfer to outside line (refer to "◆◆ Assigning and Cancelling Telephone Numbers for Call Transfer to Outside Line").

◆◆ Incomplete Call Handling

When a call is directed to your extension via the Automated Attendant service, Incomplete Call Handling will handle the calls if:

- You do not answer the call (These calls are considered "no answer" calls).
- You are on another call (These calls are considered "busy" calls).
- You have set Call Blocking (refer to "◆◆ Call Transfer").

The status you set for Incomplete Call Handling determines what happens to these calls. You can set one or more of the following for no answer calls and for busy calls separately. If you select more than one option, the caller will be prompted to select his or her desired option.

**Leaving a Message:**

The system will transfer the caller to your mailbox where he or she can leave a message for you.

**Transfer to Covering Extension:**

The system will transfer the caller to your Covering Extension (refer to "◆◆ Assigning Your Covering Extension"). If you have not assigned your Covering Extension, this option is not available.

**Intercom Paging:**

The system will page you using the Intercom Paging feature. Your name will be announced to alert you to the call.

**Transfer to Custom Service:**

The system will transfer the caller to the Custom Service you specify here.

**Transfer to Operator:**

The system will transfer the caller to the operator.



### Return to Top Menu:

The caller is returned to the top menu of the Automated Attendant service and can then choose to call a different extension.

### To set Incomplete Call Handling status

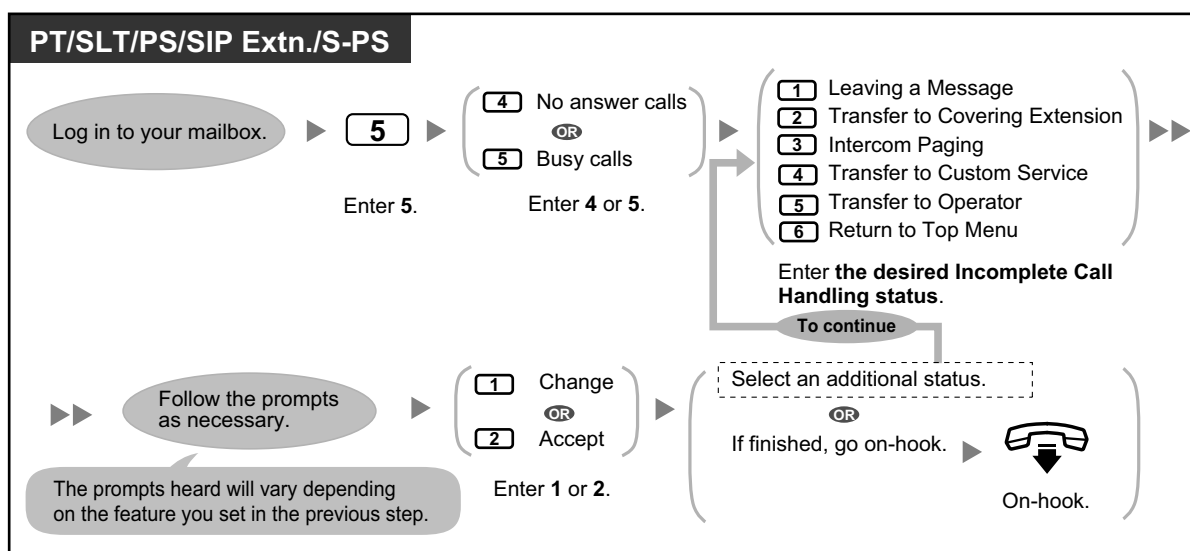

- When Call Blocking is enabled, blocked calls are treated by Incomplete Call Handling for no answer calls.

## ◆◆ Assigning Your Covering Extension

A Covering Extension is an extension that receives your calls instead of you. Your calls can be transferred to your Covering Extension in 2 ways:

- **By the Incomplete Call Handling Feature:**  
When the Incomplete Call Handling feature handles the call (i.e., if you do not answer, if you are on another call, or if you have set Call Blocking), it will be transferred to your Covering Extension if you have set Incomplete Call Handling to "Transfer to Covering Extension" (refer to "◆◆ Incomplete Call Handling").
- **By pressing the specified dialling key (0, 3–9):**  
If the caller presses the key assigned for "Transfer to the Specified Extension" during your greeting message or while recording a message for you, the call will be transferred to your Covering Extension.



- You can change the dialling key that transfers your callers to your Covering Extension. If you assign the "Transfer to Operator" option in your Personal Custom Service to a dialling key, callers who press that dialling key will be transferred to your Covering Extension (refer to "◆◆ Personal Custom Service").
- If you do not assign your Covering Extension, callers will be transferred to the operator instead.

### To assign your Covering Extension

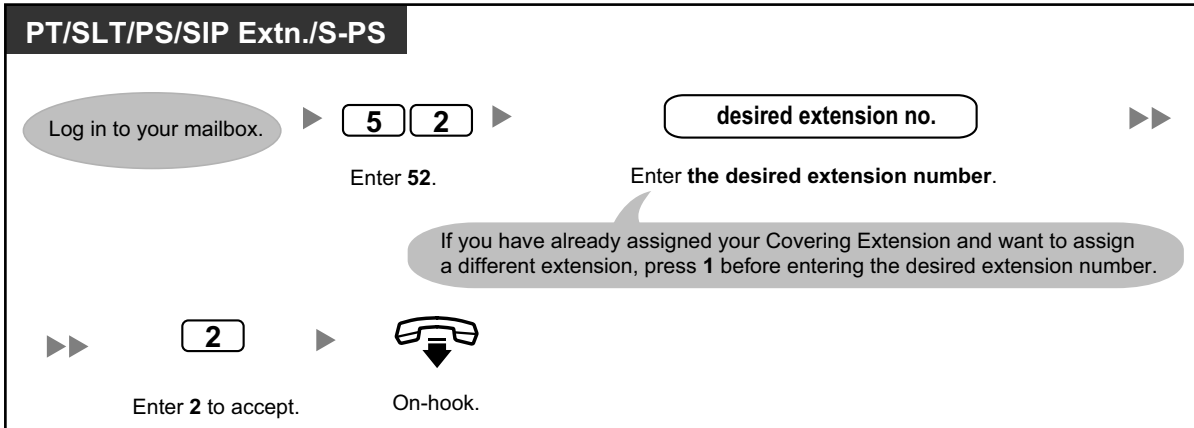

- Once you assign a Covering Extension, remember to tell callers in your greeting message that they can press the button you have assigned for transferring to your Covering Extension. For example, "To speak with my assistant, press 0".

### ◆◆ Remote Call Forwarding

You can programme the Unified Messaging system to forward your calls to another extension or to an outside telephone (if authorised). You can do this even when you are away from the office. This feature may be disabled by the System Administrator or System Manager for your mailbox. There are 6 forwarding settings available:

**FWD All:**

Forwards all incoming calls to a specified extension number.

**FWD Busy:**

Forwards all incoming calls to a specified extension number when you are already on another call.

**FWD No Answer:**

Forwards all incoming calls to a specified extension number when you do not answer your telephone.

**FWD Busy and No Answer:**

Forwards all incoming calls to a specified extension number when you are on another call or do not answer your telephone.

**FWD to Outside:**

Forwards all incoming calls to the specified outside telephone number if you are authorised to use this feature.

**FWD Cancel:**

Cancels the forwarding setting.

## To assign outside telephone numbers for Remote Call Forwarding

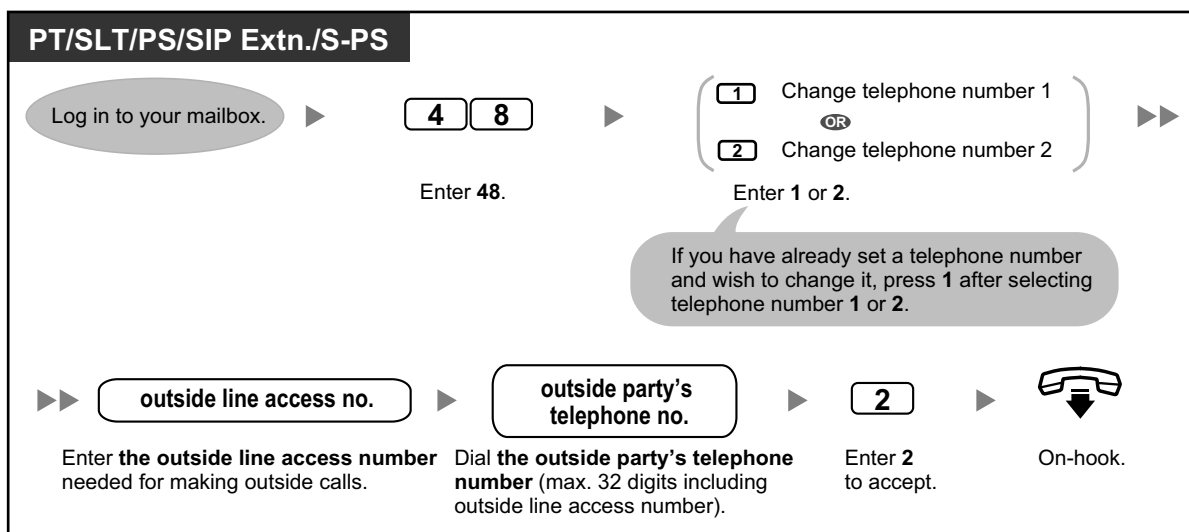

- Before you can forward your calls to an outside telephone, you should first store the telephone numbers you plan on using with this feature. You can store 2 telephone numbers for use with Remote Call Forwarding.
- If you change one of the outside telephone numbers for Remote Call Forwarding, you will need to set Remote Call Forwarding to "FWD to Outside" once again before the new outside telephone number will be used as the forward destination. If you do not do this, the old telephone number will continue to be used.

## To set/cancel Remote Call Forwarding

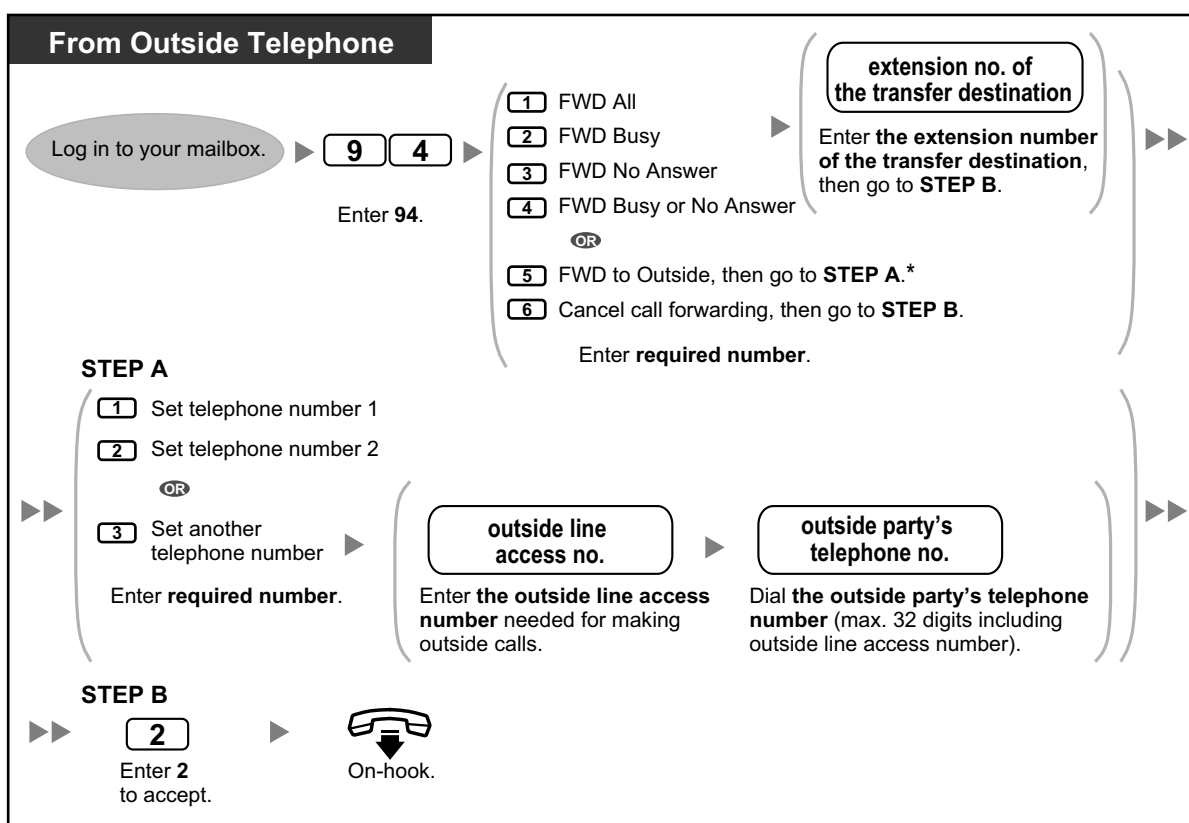

## 1.8.5 Transferring Calls



- \* This option is announced only if you are authorised to use it through system programming for PBX COS (Class of Service) settings and UM COS settings. For more information, consult your System Administrator.

### ◆◆ Assigning and Cancelling Telephone Numbers for Call Transfer to Outside Line

When you assign a telephone number for Call Transfer to Outside Line, your calls will be transferred to the assigned telephone number when:

- You have set Call Screening (refer to "◆◆ Call Transfer").
- You have set Disable Call Transfer (refer to "◆◆ Call Transfer").

#### To assign telephone numbers for call transfer to outside line

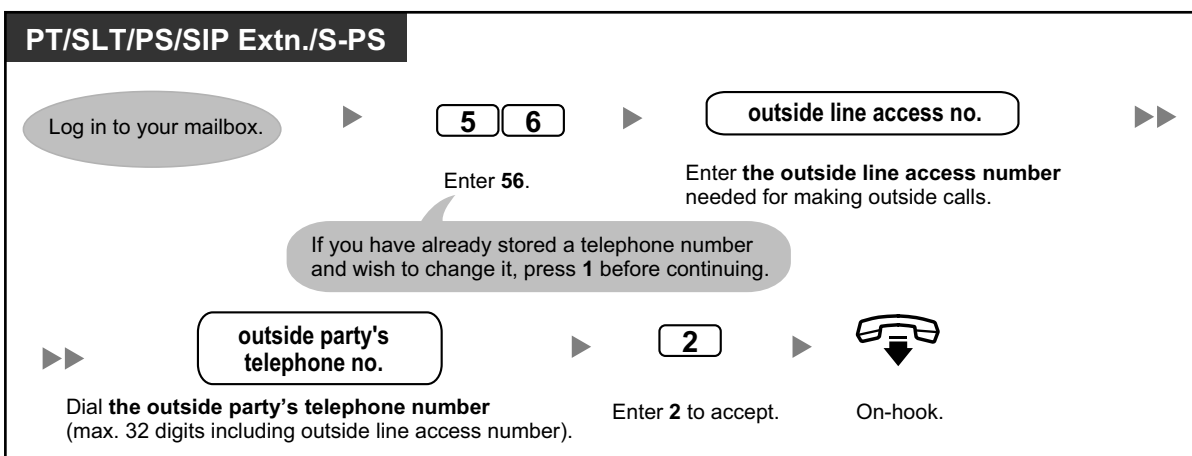

#### To cancel telephone numbers for call transfer to outside line



- This feature must be enabled for your mailbox by the System Administrator.
- If you are using a PRI line, you may need to enter # at the end of outside telephone numbers. Consult your System Administrator for more information.

### ◆◆ Voice Mail Transfer

If you cannot answer calls, you can forward them to your mailbox. You can select the type of incoming calls (Intercom Calls/Outside Calls/Both Calls) that are forwarded.

If your telephone has a Message button, the Message light turns on when a message is left in your mailbox. You will hear an indication tone\* when going off-hook, regardless of whether or not your telephone has a Message button.

You can also create a Voice Mail Transfer button on your phone to transfer received outside calls to a mailbox of another extension so that calling parties can leave messages. Using the Voice Mail Transfer button, you can also perform operations with one touch (for PT and PS only).

### To forward your calls to your mailbox

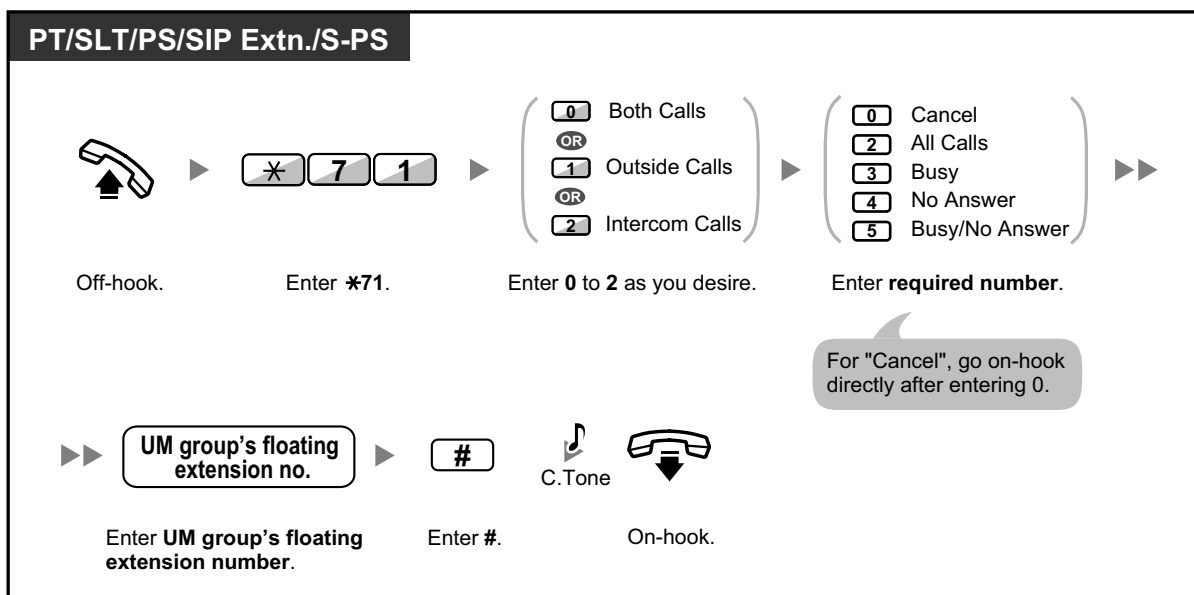

### To forward a call to your mailbox while it is ringing

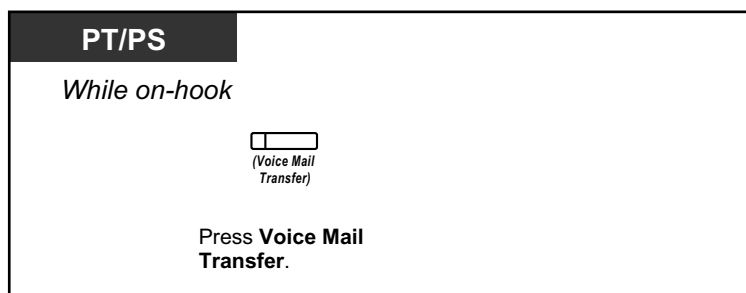

### To transfer a call to a mailbox

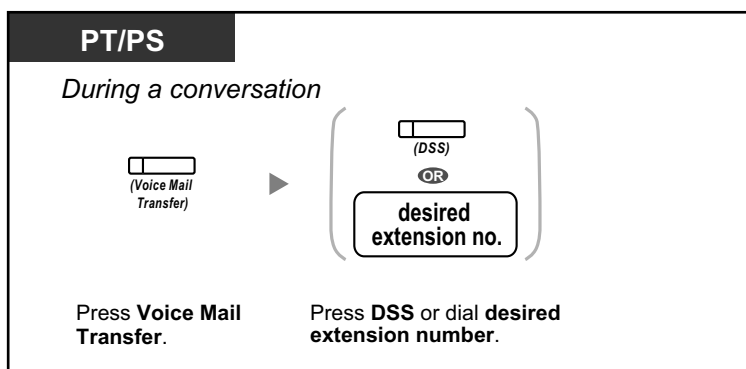

To transfer your own call to the called extension's mailbox

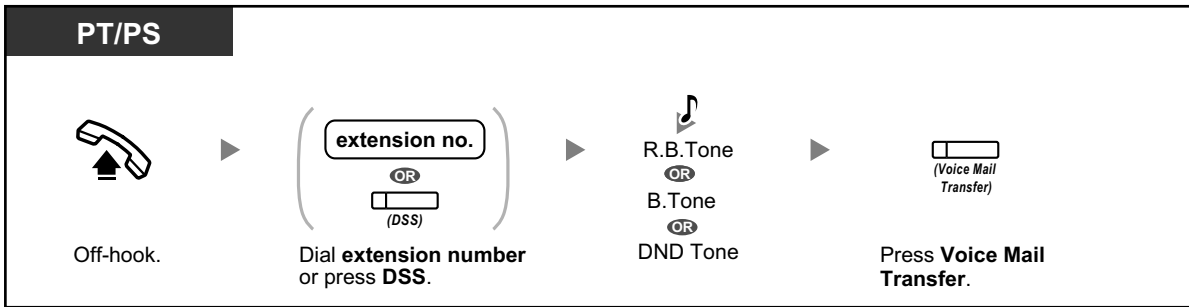

- \*Indication tone after going off-hook



- If using a PS in parallel with a PT or SLT (in Wireless XDP Parallel mode), you cannot use the Voice Mail Transfer button to forward a call to your mailbox while it is ringing.



**Customising Your Phone**

- 3.1.3 Customising the Buttons  
Create or edit a Voice Mail Transfer button or a Message button.

## 1.8.6 Other Features

- ◆◆ Interview Mailbox
- ◆◆ Message Waiting Notification
- ◆◆ Personal Caller Name Announcement
- ◆◆ Live Call Screening (LCS)
- ◆◆ Recording Your Conversation
- ◆◆ Assigning Your Telephone Numbers for Remote Automatic Log-in and Toll Saver
- ◆◆ Personal Custom Service
- ◆◆ Setting the Alarm (Timed Reminder)
- ◆◆ Setting Absent Message Remotely
- ◆◆ Call-through Service
- ◆◆ Communication Assistant plug-in for Microsoft Outlook
- ◆◆ IMAP

### ◆◆ Interview Mailbox

An interview mailbox is a mailbox designed to ask questions to callers and record their answers. If you have an interview mailbox (not all subscribers do), you can record up to 10 questions and set the answer recording time individually for each question from 1 to 60 seconds.

Your interview mailbox can be used, for example, to allow callers to place orders or request information from your company. You can ask them to record their names, address, and order or request information, and then you can note their information later while playing back their messages.



- If you would like to use this feature, you must first be assigned an Interview Mailbox. For more information, consult your System Administrator.

#### To record questions

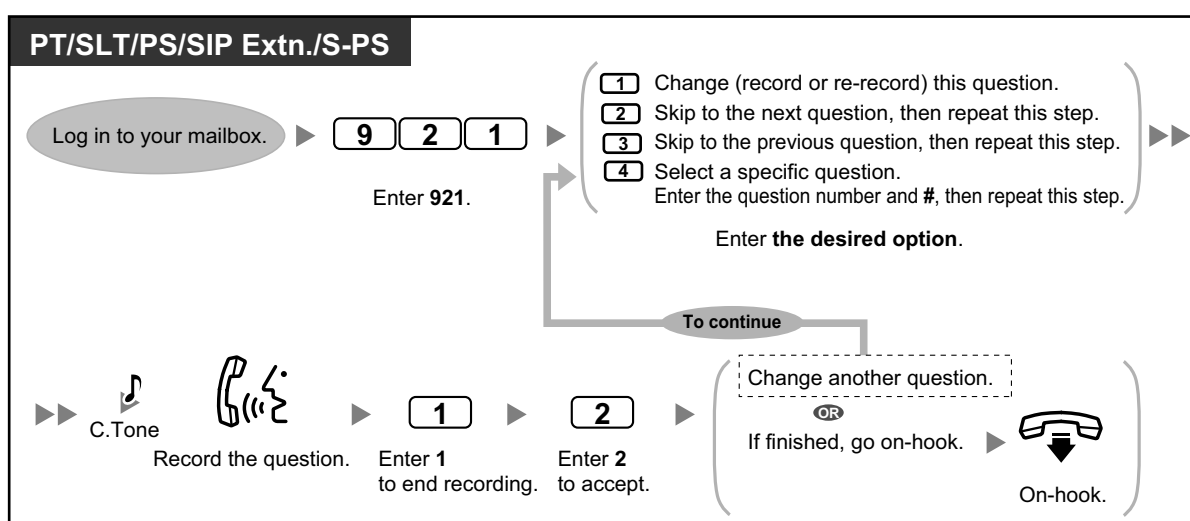

### To change answer lengths

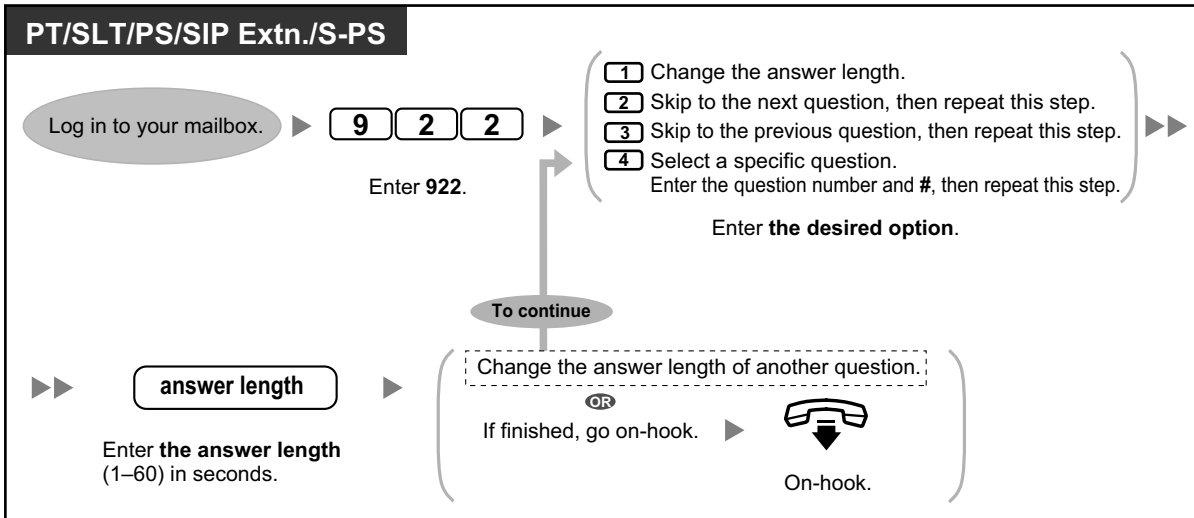

### To delete questions

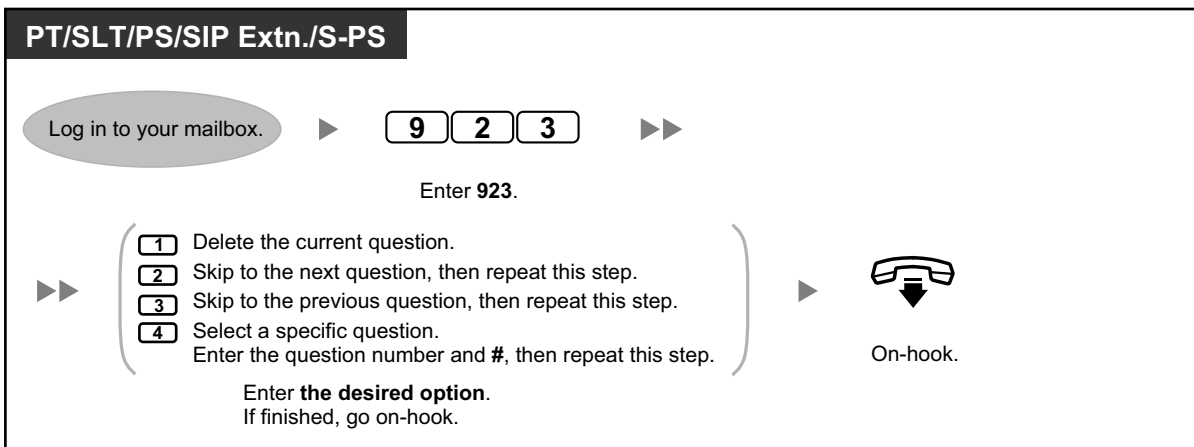

### Message Reception Mode

If you have an interview mailbox in addition to your regular mailbox, Message Reception Mode determines which mailbox is used when:

- Calls are directed to your mailbox by the "Leaving a Message" setting of the Incomplete Call Handling feature (refer to "◆◆ Incomplete Call Handling").
- Your extension is a Logical Extension (i.e., your mailbox receives your calls automatically, perhaps because you do not have your own telephone for regular use).

### To set a message mode







- Not all subscribers have interview mailboxes. For more information, consult your System Administrator.

## ◆◆ Message Waiting Notification

The Message Waiting Notification feature lets you know you have received new messages in your mailbox by:

### Message Waiting Lamp:

The message lamp on your telephone (if it has one) will light when you receive a new message. If you have a 6-line display PT, you can also see the number of new messages you have on your display. If your telephone has a Message button, the Message light will also turn on when you receive a new message.

### Device Notification:

Notifying you via a "device", i.e., an outside telephone, another PBX extension, your cellular phone, etc. You can assign three different devices. For each device, you have the option of receiving notification for urgent messages only, or for all messages. You can also choose to receive notification during certain hours only (called "scheduling"), which is useful if you do not want to be disturbed at night, for example. For more information on scheduling, consult your System Administrator.

If you turn device notification on for more than one device, the lowest numbered device (1, 2, or 3) will be used first. If notification is not possible (for example, if your outside telephone is busy), the next device will be used. Message notification by e-mail may also be available for your mailbox. When you receive new messages in your mailbox, you can receive notification by e-mail. The recorded message can also be added to the e-mail as an attachment. Consult your System Administrator for more information.



- Displaying the number of new messages is only available with a 6-line Display PT. For more information, consult your System Administrator.

### To turn Message Waiting Lamp Notification On/Off

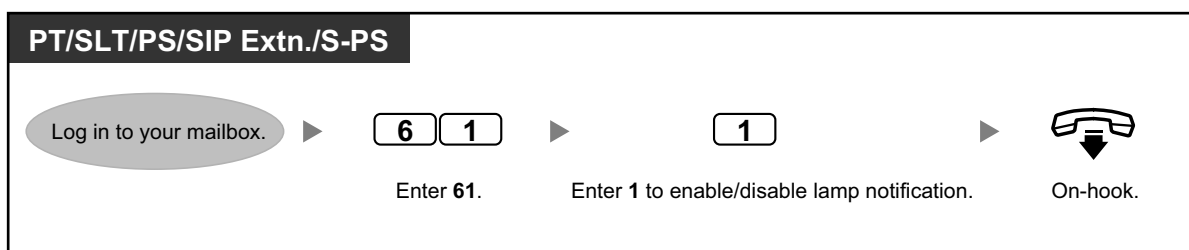

**To turn Device Notification On/Off**

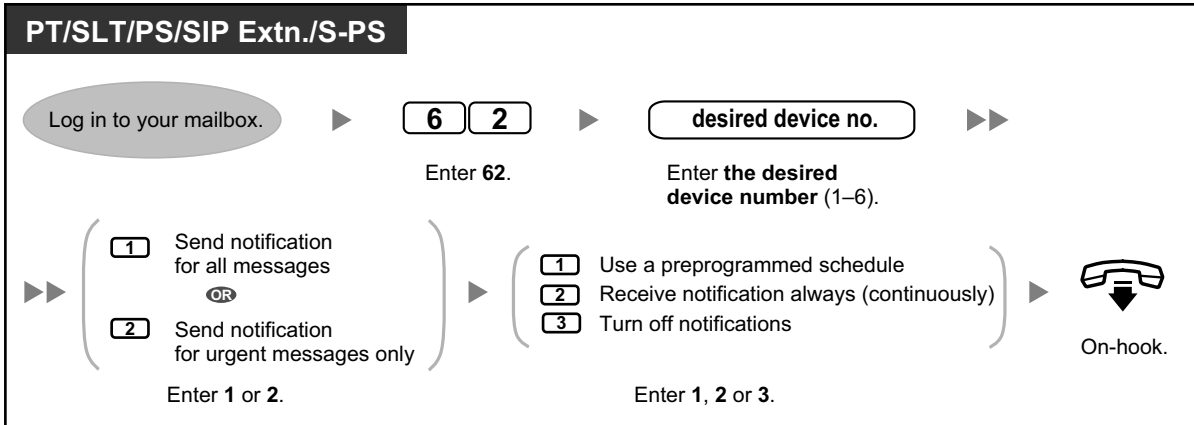

- Device number 4, 5, or 6 is used to specify a device number that is "Device No. 1, 2, or 3" for "E-mail/Text Message Device" in Web Maintenance Console.
- To use the Device Notification feature for device number 1, 2, or 3, the telephone number for each device should first be assigned.

**To change device numbers**

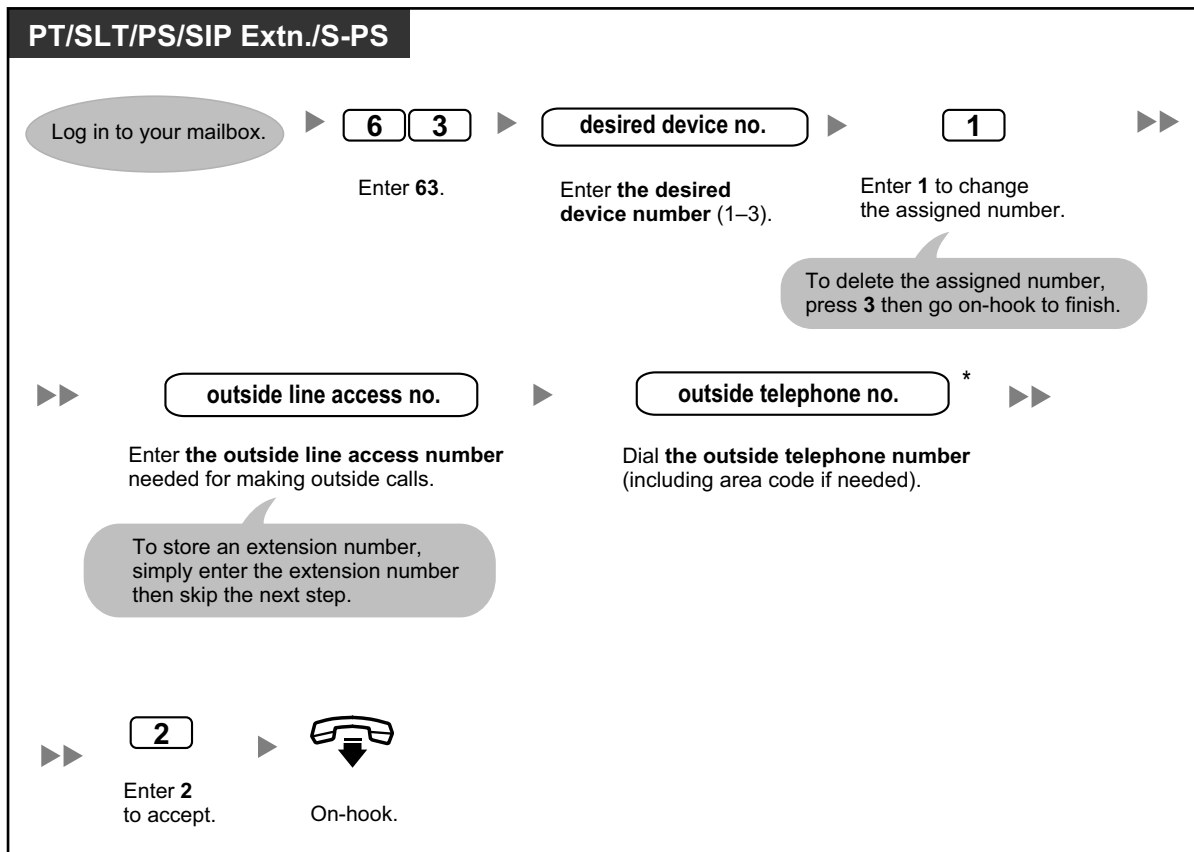



- \* If you are using an ISDN or SIP line in en bloc dialling mode, to insert a pause or special command in the middle of the telephone number, pause momentarily while entering the telephone number. You will hear a list of available options, for example, "To add more digits, press 4. To insert a pause, press 5."
- If you are using a PRI line, you may need to enter # at the end of outside telephone numbers. Consult your System Administrator for more information.

## ◆◆ Personal Caller Name Announcement

By storing caller telephone numbers and recording caller names, you can have the Unified Messaging system announce the caller name to you when:

- You play back a message from one of the assigned callers.
- The system transfers a call to you from one of the assigned callers.
- The system pages you to inform you that you have a call from one of the assigned callers.

This feature may be disabled by the System Administrator or System Manager for your mailbox.

### To assign Caller ID numbers and recording names

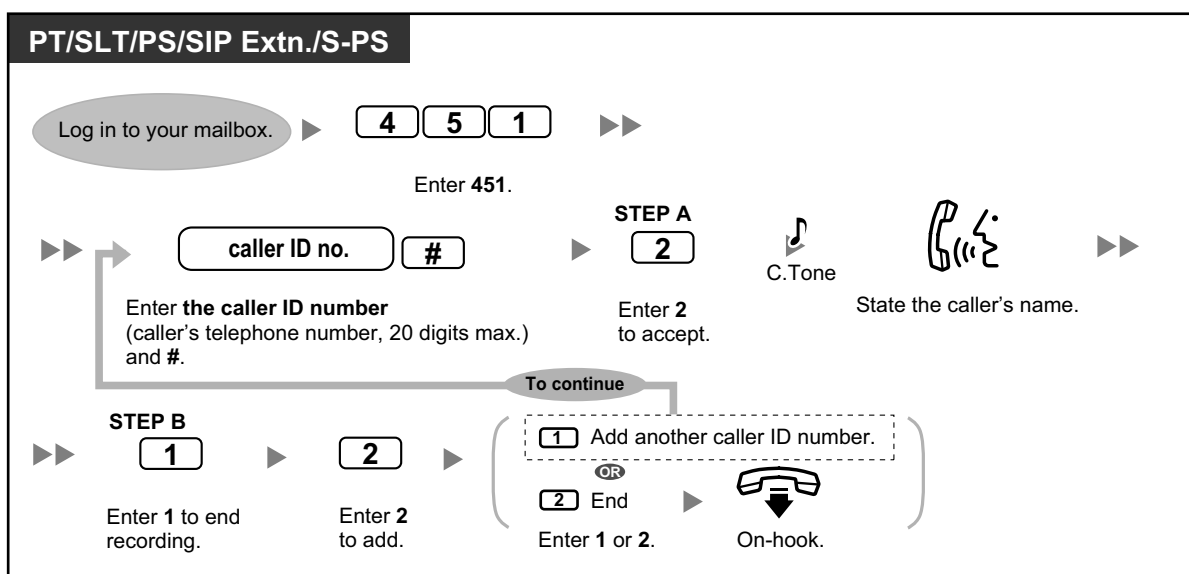

**To change Caller ID numbers and recorded names**

**PT/SLT/PS/SIP Extn./S-PS**

Log in to your mailbox. ▶ **4** **5** **2** ▶▶

Enter 452.

▶▶ ( **1** Change the Caller ID number, then go to **STEP A** in "To assign Caller ID numbers and recording names". **OR** **2** Change the caller's name, then go to **STEP B** in "To assign Caller ID numbers and recording names". **OR** **3** Accept the current item as is and skip to the next item, then repeat this step. ) ▶▶

▶  On-hook.

**To delete Caller ID numbers and recorded names**

**PT/SLT/PS/SIP Extn./S-PS**

Log in to your mailbox. ▶ **4** **5** **3** ▶▶

Enter 453.

( **1** Delete all numbers, then go on-hook to finish. **OR** **2** Delete one number. ) ▶▶

Enter 1 or 2.

▶▶ ( **1** Delete the announced number. **OR** **2** Keep the number and announce the next number, then repeat this step. ) ▶▶

▶  On-hook.

Enter 1 or 2.  
When finished, go on-hook.



- The number of callers you can assign for this feature is controlled by the System Administrator.

**◆◆ Live Call Screening (LCS)**

While a caller is leaving a message in your mailbox, you can monitor the call without answering. If you so desire, you can answer the call while monitoring. There are two methods available (Default: Hands-free mode).



**Hands-free mode:**

You can monitor the message automatically, live through the telephone speaker.

**Private mode:**

You will hear an alarm tone while the caller is leaving a message.

### Before operating

- Create a Live Call Screening (LCS) button (Personal Programming).
- Select the mode, either Hands-free or Private (Personal Programming).
- Set the extension PIN (Personal Identification Number).
- Set the Live Call Screening feature.

### To set Live Call Screening

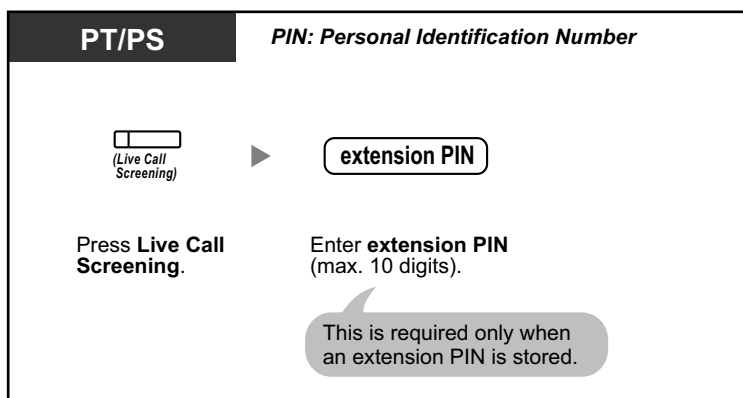

### To cancel Live Call Screening

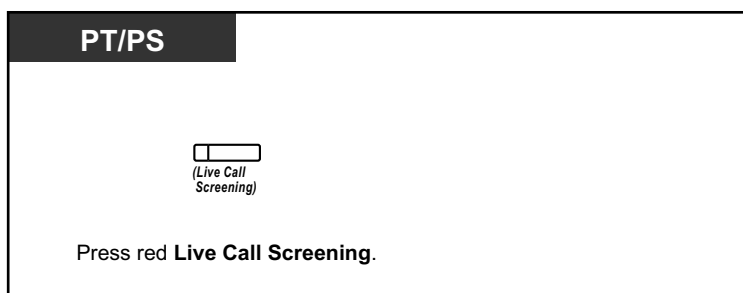

### Operation Flowchart

The operations in the shaded areas can be done hands-free.

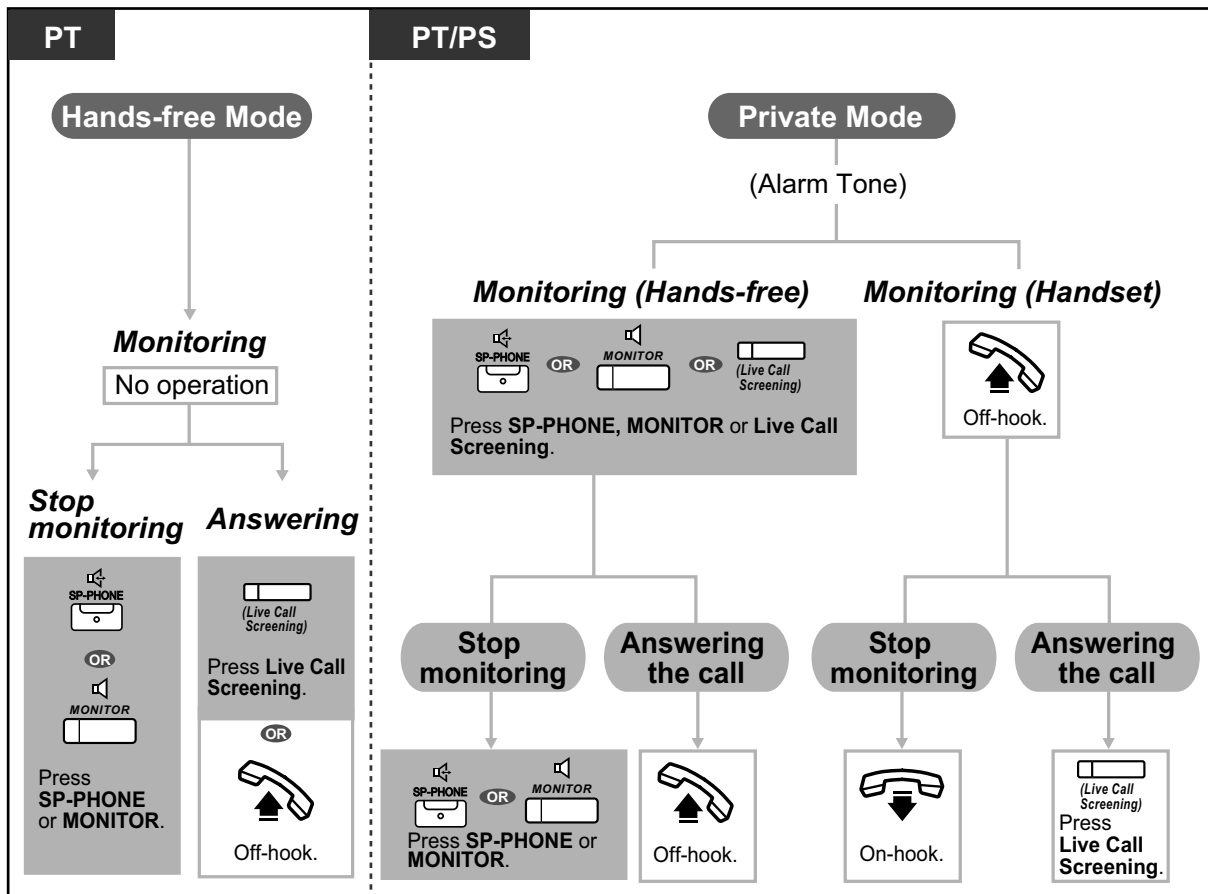

- The Live Call Screening (LCS) button light shows the feature status as follows:
  - Off:** LCS is off.
  - Flashing green rapidly:** Alerting in the Private mode.
  - Flashing green slowly:** Monitoring.
  - Red on:** LCS is on.
- The manager extension can clear an extension PIN.
- This feature is available for a single line telephone if it is connected to a proprietary telephone in parallel. (Private mode only)
  - To answer the call while monitoring, press Recall/hookswitch.
- Only the handset monitoring in the Private mode is available for PS users.



### Customising Your Phone

- 3.1.2 Settings on the Programming Mode—**Live Call Screening Mode Set**
  - Select the mode, either monitoring the message through the speaker automatically or receiving, while the caller leaves a message.
- 3.1.3 Customising the Buttons
  - Create or edit a Live Call Screening (LCS) button.

## ◆◆ Recording Your Conversation

You can record a conversation into a mailbox while talking on the phone. You can select the mailbox each time you record a conversation.



### To record into your mailbox (Two-way Record)

**PT/PS**

*During a conversation*

 (Two-way Record)

To stop recording, press this button again.

Press **Two-way Record**.

### To record into another mailbox (Two-way Transfer)

**PT/PS**

*During a conversation*

 (Two-way Transfer)

Press **Two-way Transfer**.

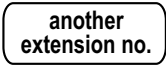
 (DSS)  
OR  
 another extension no.

Press **DSS** or enter another extension number.

To stop recording, press this button again.

### To record into another mailbox with one touch (One-touch Two-way Transfer)

**PT/PS**

*During a conversation*

 (One-touch Two-way Transfer)

Press **One-touch Two-way Transfer**.



- The Two-way Record button light, Two-way Transfer button light or One-touch Two-way Transfer button light shows the current status as follows:  
**Off:** Not recording.  
**On:** Recording the conversation.

**Note**

When you record your Two-way telephone conversations, you should inform the other party that the conversation is being recorded.



- If all Unified Messaging system ports are busy when you try to use one of these features, you will hear a warning tone, dial tone, or busy tone, depending on the feature you are trying to use.
- Recording time when using these features may be limited. For more information, consult your System Administrator.



**Customising Your Phone**

- 3.1.3 Customising the Buttons  
 Create or edit a Two-way Record button, a Two-way Transfer button and a One-touch Two-way Transfer button.

**◆◆ Assigning Your Telephone Numbers for Remote Automatic Log-in and Toll Saver**

When logging in to your mailbox remotely (i.e., from an outside telephone) to listen to your messages, the Remote Automatic Log-in (refer to "◆◆ Remote Access") and Toll Saver features identify you by recognising your telephone number (caller ID). In order to use these features, you must first store the telephone numbers that you will use to access your mailbox remotely.

Automatic Log-in and Toll Saver may be disabled by the System Administrator for your mailbox.

**To assign**

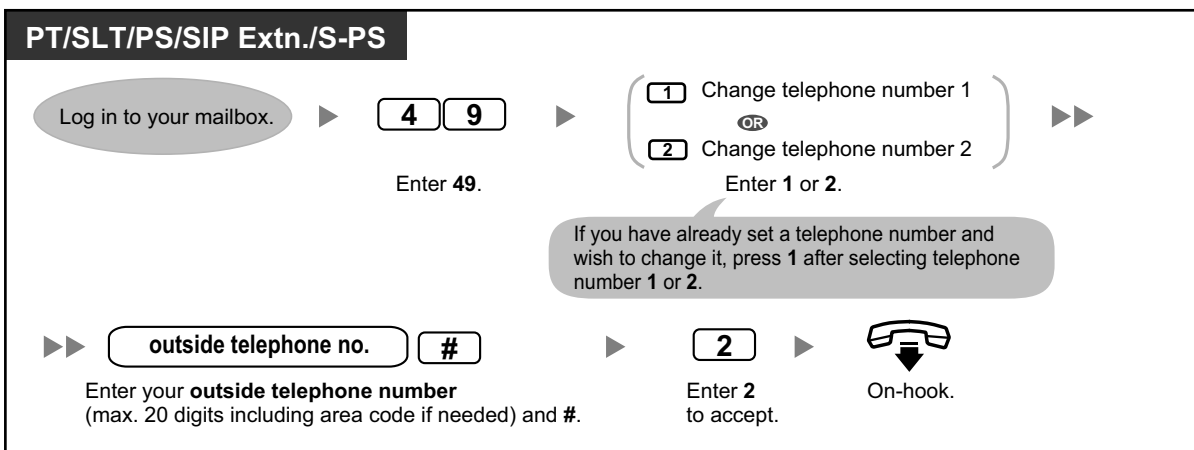

- The System Administrator must enable Automatic Log-in and Toll Saver for your mailbox before it can be used.



## ◆◆ Personal Custom Service

A Personal Custom Service is a set of options you can present to your callers, allowing them to press buttons on their telephones in order to access certain features. You should explain the options available to your callers in each of your personal greeting messages, for example, "This is (name). I can't take your call right now. Press 3 to leave me a message. Press 4 to speak with my assistant. Press 5 to dial another extension...". For details on recording your greeting messages, refer to "◆◆ Changing or Deleting Your Personal Greeting Messages" or "◆◆ Personal Greetings for Caller ID".

You can create your own personal custom service and allow your callers to access the following features:

### Transfer to Mailbox:

The system will transfer the caller to your mailbox (or another mailbox you specify here) where he or she can leave a message.

### Transfer to Extension:

The system will transfer the caller to the extension you specify when creating the custom service.

### Transfer to Outside:

The system will transfer the caller to the outside telephone number you specify when creating the custom service. This feature must be enabled for your mailbox by the System Administrator or System Manager.

### Transfer to Custom Service:

The system will transfer the caller to the Custom Service you specify here.

### Voice Mail Service:

The system will prompt the caller to enter a mailbox number and leave a message.

### Automated Attendant Service:

The system will prompt the caller to dial an extension number in order to speak with someone else.

### Intercom Paging:

The system will page you using the Intercom Paging feature. Your name will be announced to alert you to the call.

### Repeat Greeting:

The caller can play your greeting message back from the beginning in order to listen to your Personal Custom Service options once again.

### Transfer to Operator:

The system will transfer the caller to the operator, or to your Covering Extension if you have assigned one (refer to "◆◆ Assigning Your Covering Extension").

You can also select what happens when a caller makes no selection (No DTMF Input Operation) while listening to your greeting, perhaps because the caller is using a rotary/pulse telephone. The caller can either be transferred to your mailbox or be disconnected.



- The following dialling keys are assigned to the following features by default, and cannot be changed.

1	End recording
2	Begin recording while listening to personal greeting message

✖	Exit
---	------

**To create your personal custom service**

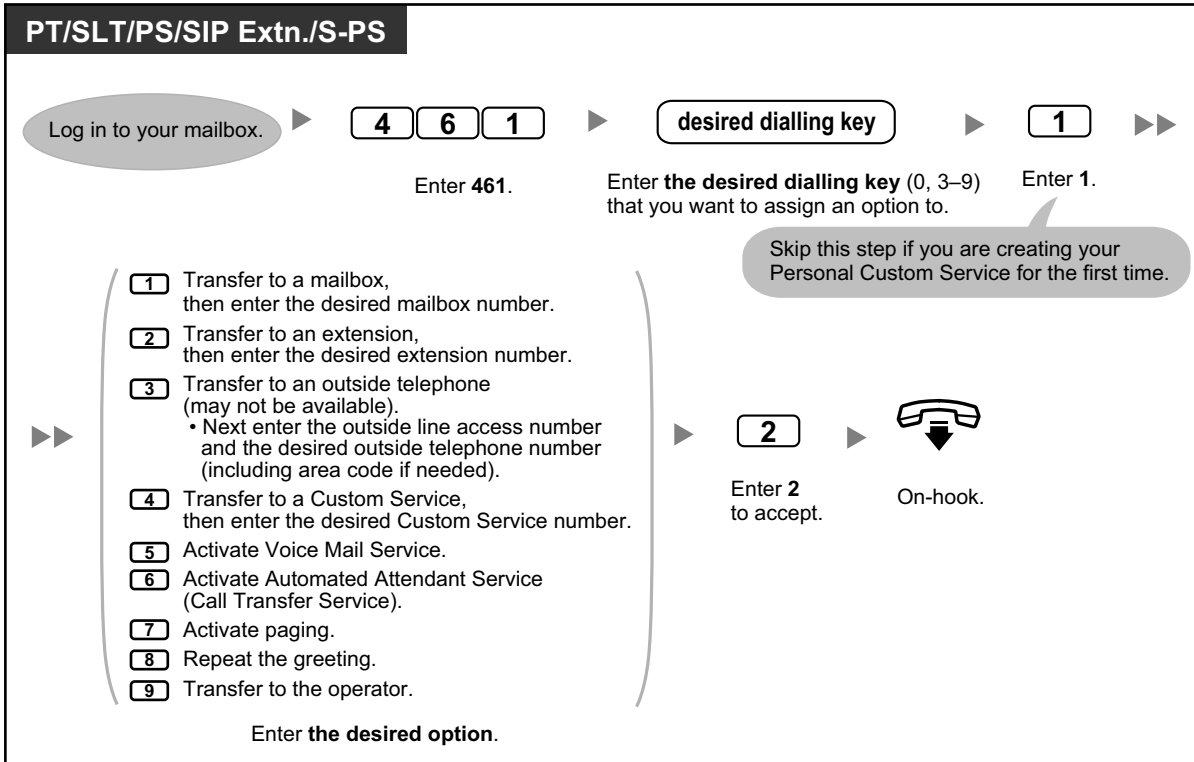

**To delete options from your personal custom service**

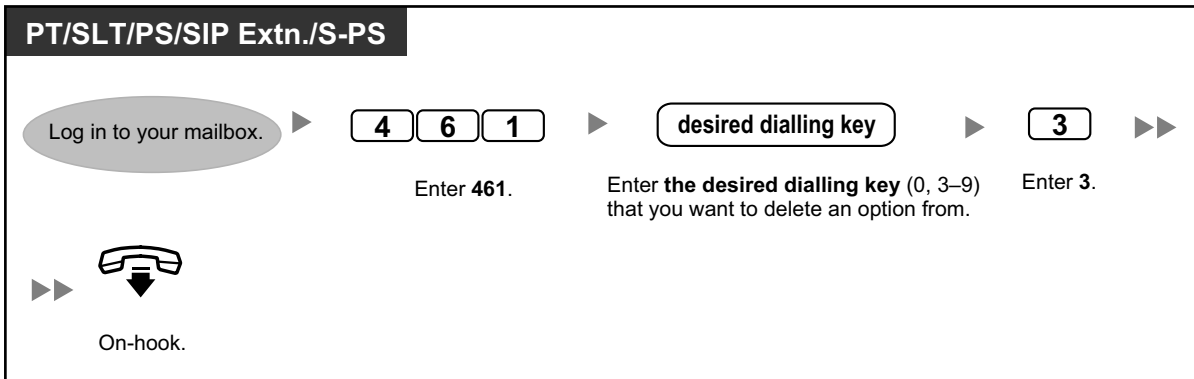

### To select the No DTMF Input operation

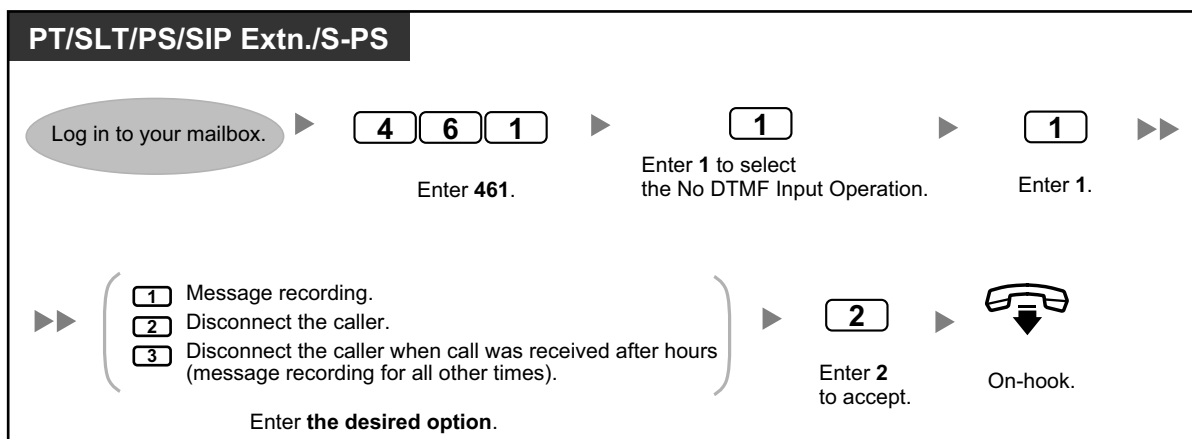

### To confirm the settings for your personal custom service

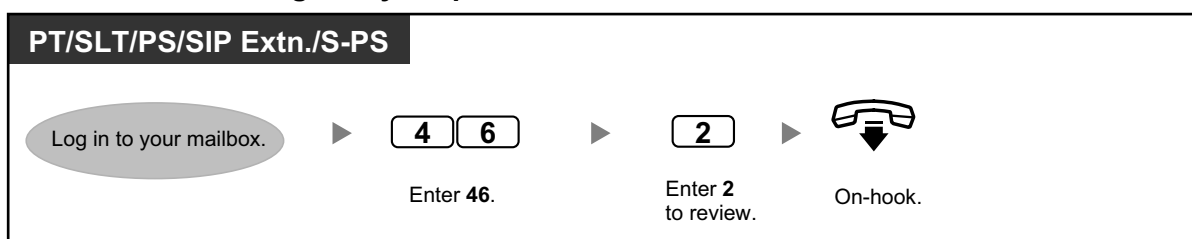

- The System Administrator or the System Manager must enable Transfer to Outside for your mailbox before it can be used.
- The Transfer to Outside option can be used a maximum of 4 times in your Personal Custom Service.
- If you are using a PRI line, you may need to enter # at the end of outside telephone numbers. For more information, consult your System Administrator.

## ◆◆ Setting the Alarm (Timed Reminder)

You can receive an alarm at your telephone to remind you of a meeting, appointment or as a wake-up call. The alarm can occur either once or daily (every day until cancelled) at a preset time. When you go off-hook to answer, you will hear a special dial tone or prerecorded message.

To set/cancel

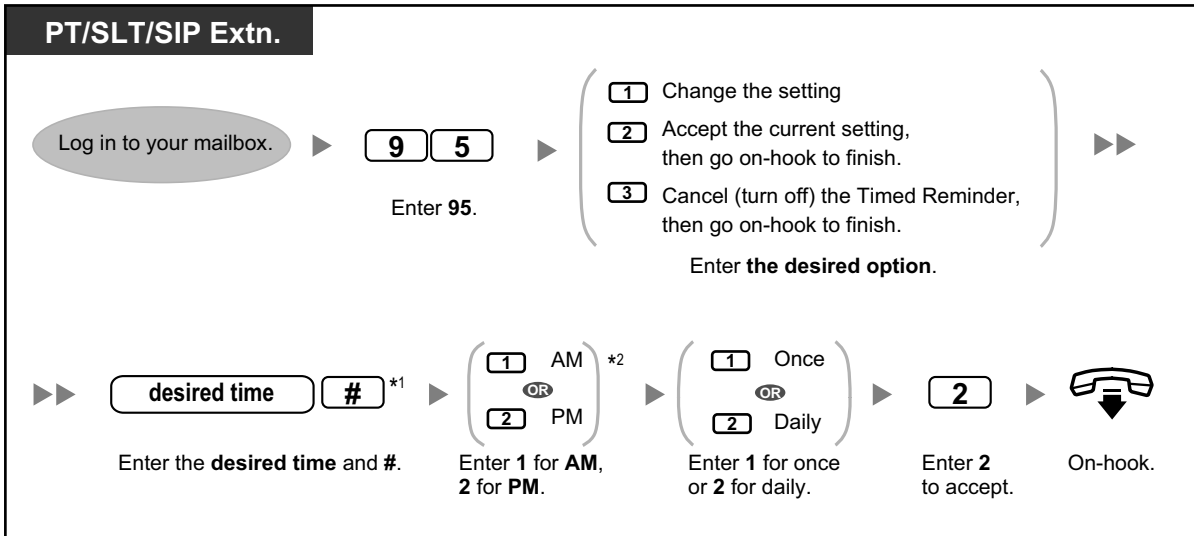

- \*1 Example: To enter 5:00, press **5#**. To enter 5:15, press **515#**.
- \*2 This option may not be available if the system is programmed to use 24-hour time.

◆◆ **Setting Absent Message Remotely**

You can set your absent message by accessing the subscriber service menu. To login to your mailbox from an outside telephone, refer to "◆◆ Remote Access".

To set/cancel

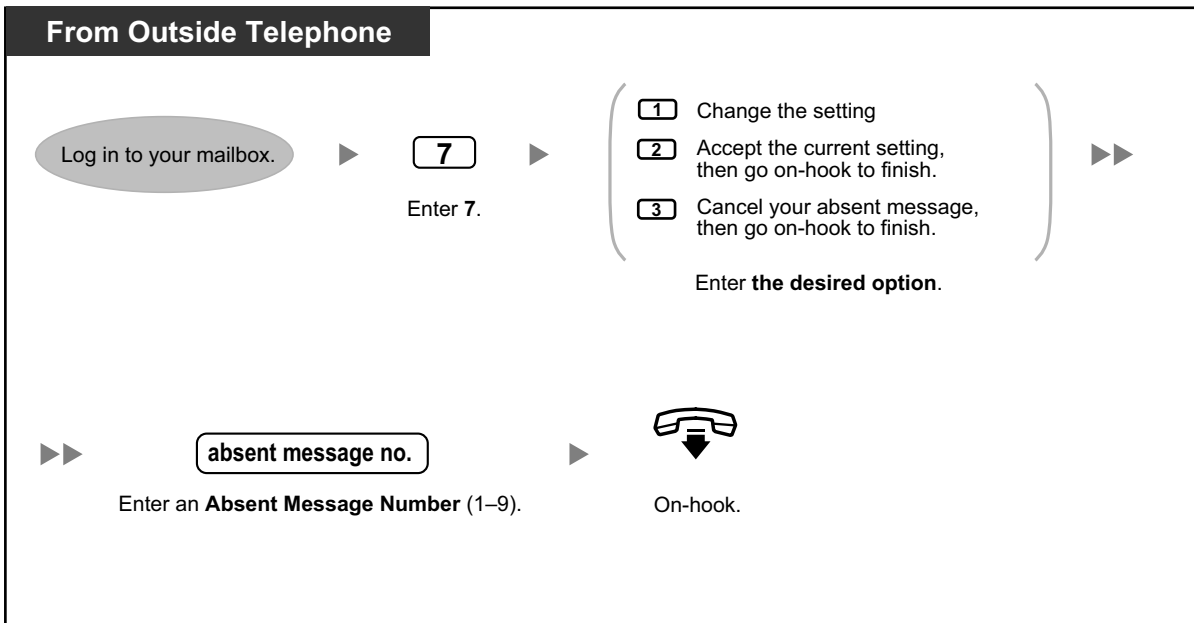

## ◆◆ Call-through Service

You can make outside calls by accessing the subscriber service menu (from an outside telephone) and dialling an outside destination. To login to your mailbox from an outside telephone, refer to "◆◆ Remote Access".

### To call an outside party

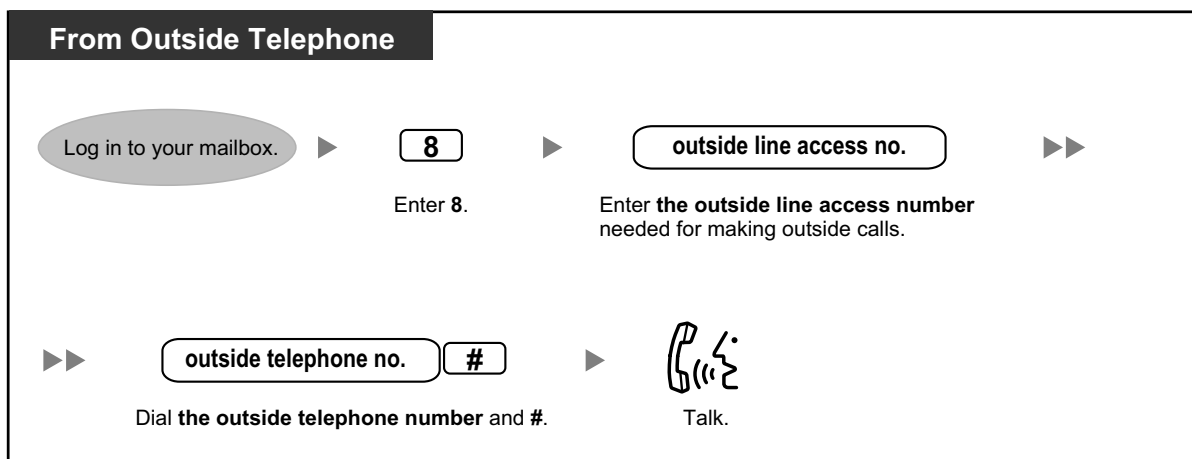

- This feature must be enabled for your mailbox by the System Administrator.

## ◆◆ Communication Assistant plug-in for Microsoft Outlook

If the Communication Assistant plug-in for Microsoft Outlook is installed to your PC, you can access the contents of your mailbox from your PC through Microsoft Outlook. Voice messages appear in subscribers' inboxes as e-mail messages.

With the Outlook plug-in, you can do the following:

- Play back voice messages on a PC or through a telephone
- Record and send voice messages from a PC or telephone
- Forward and reply to messages to another subscriber
- Call back the sender of a message quickly when the message has caller information included
- Export voice message data
- Attach voice messages to other e-mail messages



- For details about using the Outlook Plug-in, refer to the documentation of Communication Assistant.

## ◆◆ IMAP

If your e-mail client supports IMAP4, you can access the contents of your mailbox through an e-mail client and you can do the following:

- Play back voice messages
- Save voice message data to your PC
- Delete voice messages



- For configuring an IMAP account, consult your System Administrator.

### UM IMAP Session Controller for Microsoft Outlook

If you will be accessing Unified Messaging data through an IMAP connection, you must install the IMAP Session Controller software. This software is a plug-in for Microsoft Windows. When installed, it appears in the notification area. The software changes the selected account in the Outlook user interface from the Unified Messaging IMAP account to the default Outlook inbox after a specified time period. Doing so enables multiple users efficiently interact with the KX-NS300 through Microsoft Outlook.

#### To download IMAP Session Controller

You can download the IMAP Session Controller software from Web Maintenance Console:

1. Log in to Web Maintenance Console.
2. On the **Edit User** screen, click the **Unified Message** tab.
3. Click **Download** for **Unified Messaging Plug in** to access the download site for the IMAP Session Controller software.



- For details about Web Maintenance Console, refer to "3.2 System Programming Using Web Maintenance Console".

#### To install IMAP Session Controller

Double-click **UmicSetup.exe**, and then follow the on-screen guidance to install the software.

#### To uninstall IMAP Session Controller

Uninstall this software using the programme uninstall feature in the Control Panel. For details, refer to the documentation for your operating system.

#### To configure settings and view information

While this software is running, you can configure settings and view information about the software. Right-click the icon in the notification area, and then select an item.

#### Notification area icon



Item	Description
<b>Settings</b>	<b>Language</b> Select the language to use for the settings dialogue box and the notification area menu.
	<b>No Operation Timer</b> Enter the time period after which the selected account is changed from the Unified Messaging account to the default Outlook inbox if there has been no user activity. Timer value: 30 to 600 seconds (Recommended timer value: 30 to 60 seconds)

---

Item	Description
	<p><b>E-Mail Account for UM</b> Enter your Unified Messaging e-mail account. The maximum size is 256 characters. If nothing is entered, all of the e-mail accounts using IMAP are assumed to be Unified Messaging accounts. You can copy the mail account from <b>Mail Account</b> in the <b>General</b> tab of the <b>Internet E-mail Settings</b> dialogue box.</p> <ul style="list-style-type: none"><li>• To open the <b>Internet E-mail Settings</b> dialogue box:<ul style="list-style-type: none"><li>– In Outlook 2007, click the <b>Tools</b> menu → <b>Account Settings</b> → <b>Change</b> → <b>More Settings</b> button.</li><li>– In Outlook 2010, click the <b>File</b> menu → <b>Info</b> → <b>Account Settings</b> → <b>Change</b> → <b>More Settings</b> button.</li></ul></li></ul>
<b>About</b>	Display the copyright and version of this software.
<b>Exit</b>	Exit this software.

## 1.8.7 Quick Reference

The flow below includes all top menu options and frequently used features. Only options 1–4 and 0 are announced in the top menu when accessed. If you press 0 (help menu), you can listen to the whole top menu (options 1–9).

The help menu may not be available from the top menu depending on the COS settings of your mailbox.

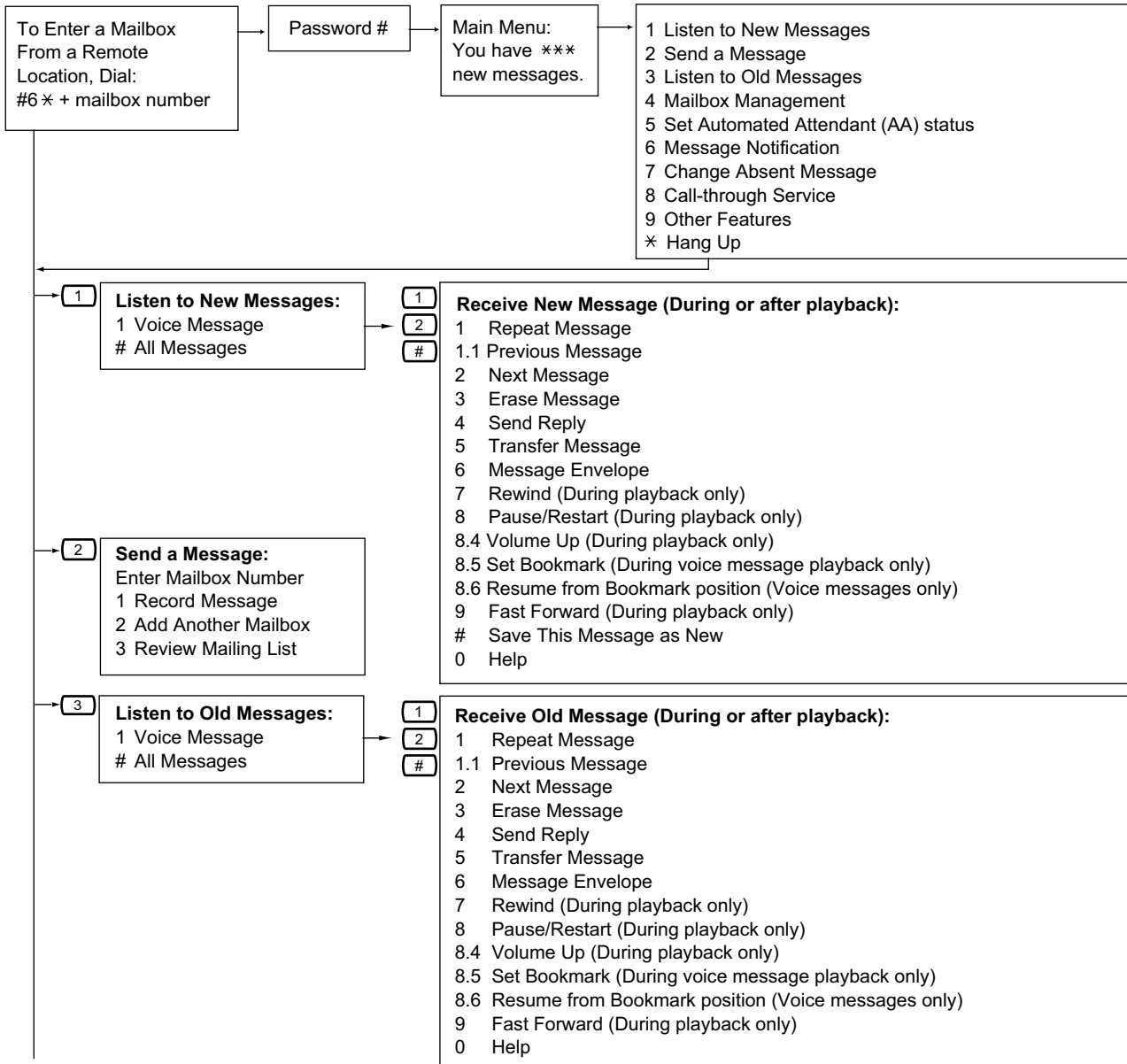

Continued on next page



Continued from previous page

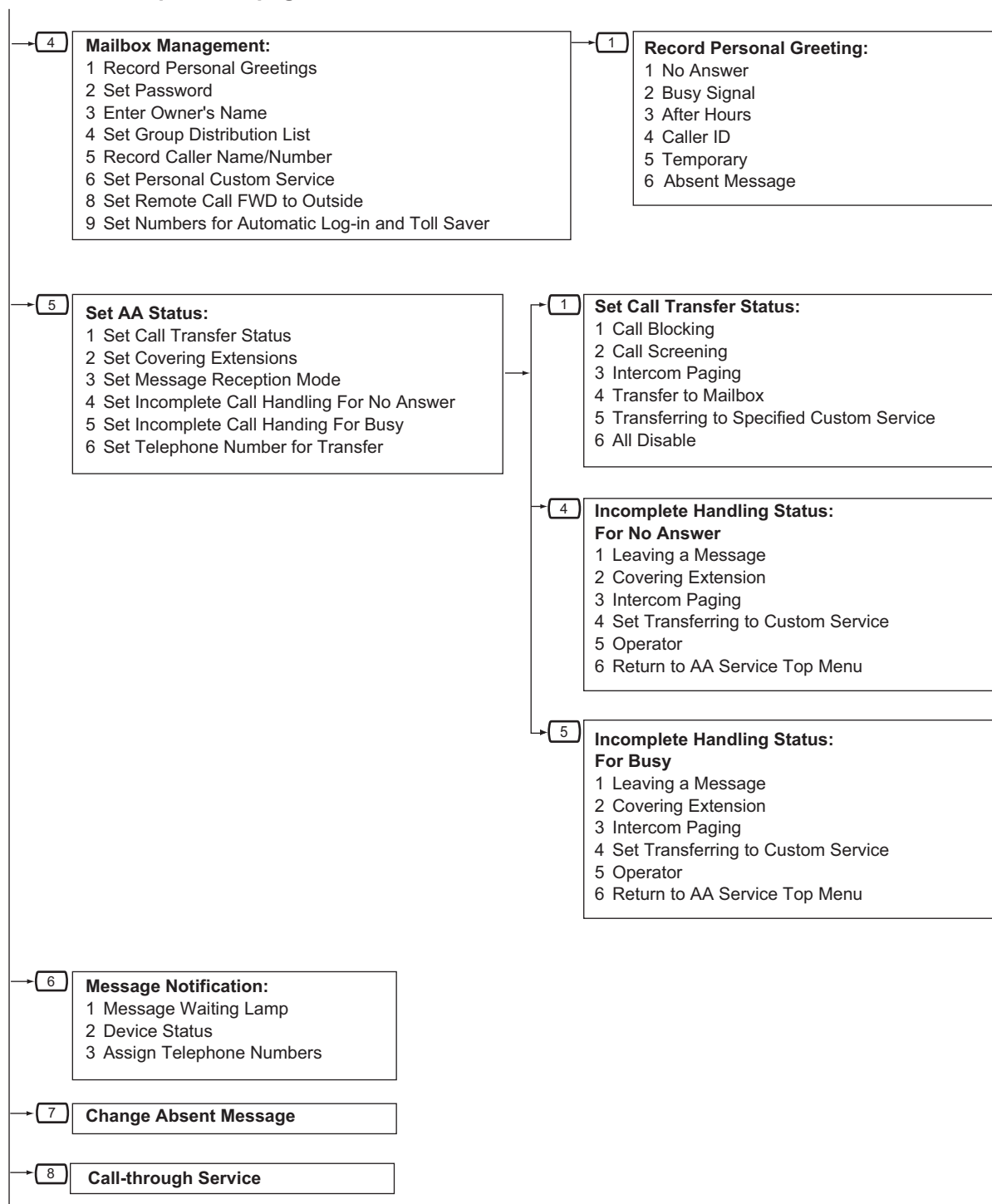

Continued on next page

Continued from previous page

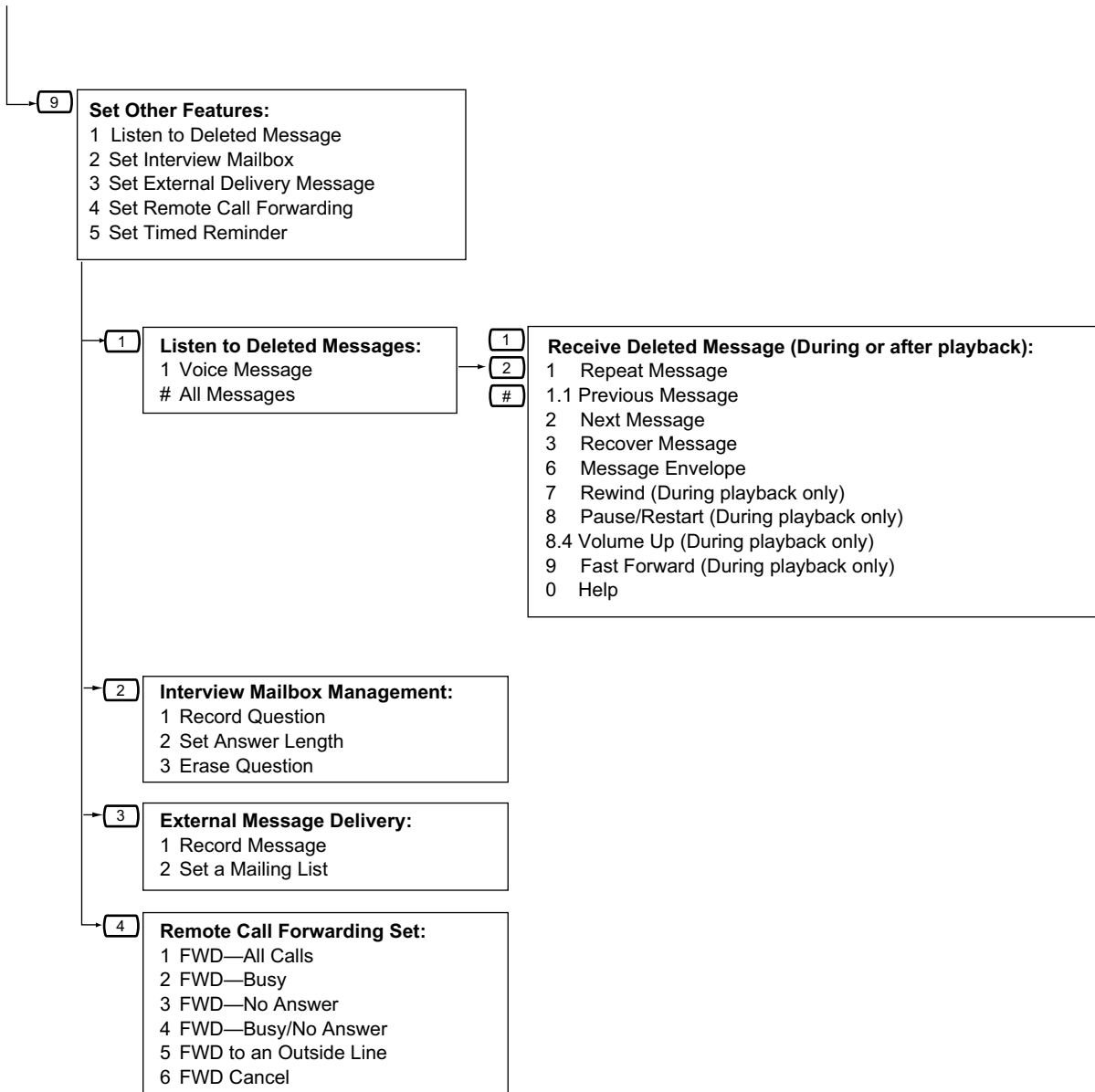

# 1.9 Setting the Telephone According to Your Needs

## 1.9.1 Setting the Alarm (Timed Reminder)

You can receive an alarm at your telephone to remind you of a meeting, appointment or as a wake-up call. The alarm can occur either once or daily (every day until cancelled) at a preset time. When you go off-hook to answer, you will hear a special dial tone or prerecorded message.

### To set

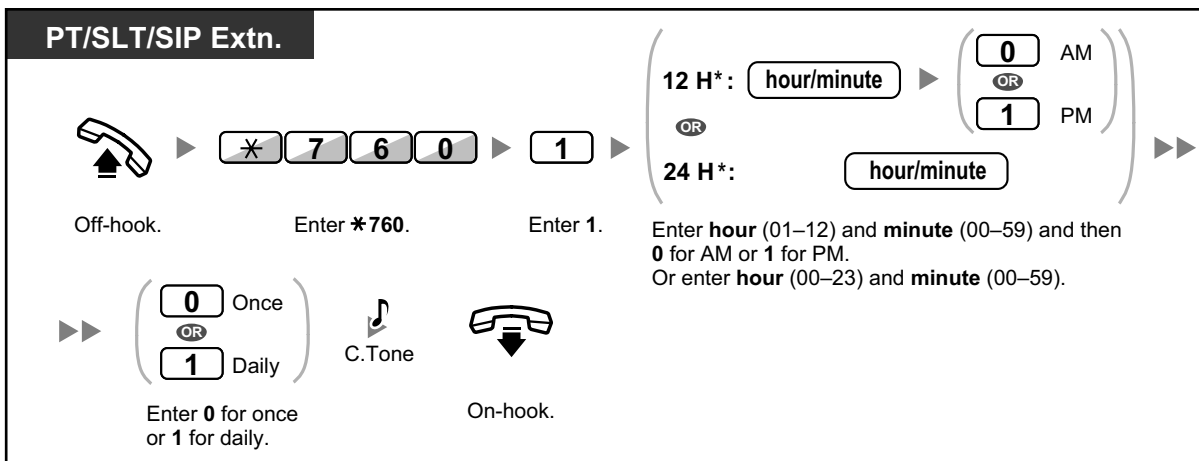

- \* Enter the time in the format assigned to your PBX (12-hour or 24-hour).

### To cancel

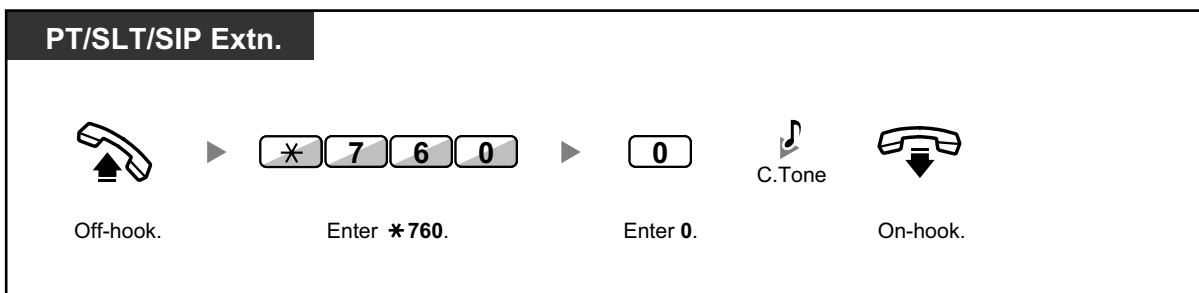

### To stop or answer the ringback

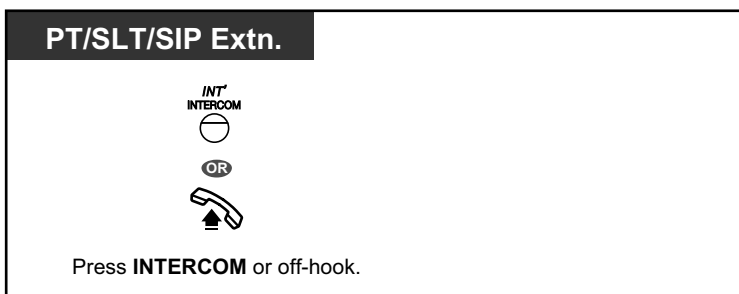

## 1.9.1 Setting the Alarm (Timed Reminder)

---

### To confirm



- You can also confirm the Timed Reminder by using the soft button.
- The alarm keeps ringing for preprogrammed seconds.
- **If you receive an incoming call during ringback**, the ringing starts after the ringback stops.
- **If you are having a conversation exceeding alarm ringing period**, the ringback will start after your conversation.

## 1.9.2 Refusing Incoming Calls (Do Not Disturb [DND])

- ◆◆ Do Not Disturb (DND)
- ◆◆ Switching FWD/DND Status Using Fixed FWD/DND Button

### ◆◆ Do Not Disturb (DND)

You can set this feature to prevent incoming calls from ringing at your extension. This can be useful, for example, when you are in a meeting or busy.

#### To set/cancel

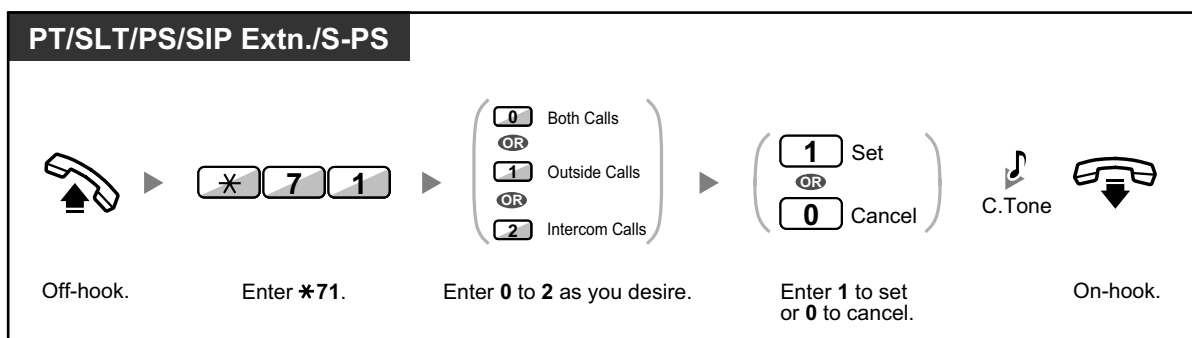

- When using a proprietary telephone, you can set or cancel Do Not Disturb by pressing the FWD/DND button (fixed button) instead of "\*710".  
When using a KX-UT series SIP phone (except KX-UT670), you can also press the FWD/DND button and then press up or down with the Navigator Key to set or cancel Do Not Disturb for all calls. For KX-UT670, there is no physical FWD/DND button on the phone. For details, refer to the documentation for your phone.



- For KX-UT series SIP phones (except KX-UT670), when Call Forwarding or Do Not Disturb is enabled, FWD/DND appears on the display in stand-by mode. For KX-UT670, when Call Forwarding or Do Not Disturb is enabled, a status icon appears on the display. For details, refer to the documentation for your phone.
- The FWD/DND button light shows the current status as follows:
  - Off:** Both features are not set.
  - Red on:** FWD mode
  - Flashing red slowly:** DND mode
 For KX-UT series SIP phones, you can see the current status on the display.

## 1.9.2 Refusing Incoming Calls (Do Not Disturb [DND])

- The system has two modes: (1) FWD/DND Cycle Switch Mode and (2) FWD/DND Setting Mode. Ask your manager what mode your system is in if you are not sure. For KX-UT series SIP phones, only FWD/DND Setting Mode is supported.

### (1) When in FWD/DND Cycle Switch Mode:

Pressing the FWD/DND button (fixed button) while in idle status will cycle the setting as shown below:



### (2) When in FWD/DND Setting Mode:

Pressing the FWD/DND button (fixed button) while in idle status allows you to switch the FWD/DND status and set the FWD destination (refer to "◆◆ Switching FWD/DND Status Using Fixed FWD/DND Button").

#### **Note**

A FWD/DND button (customised button) is always in FWD/DND Cycle Switch Mode: the mode cannot be changed.

- If your extension has set this feature, a calling extension will hear DND tone.
- If this feature is set, the Call Forwarding (FWD) feature does not work.
- Specified extensions can override this feature and call DND extensions (DND Override).
- When making a call using an SDN button to a PDN extension with DND set, this feature will temporarily be deactivated.
- When intercom calls are set to be handled differently from outside calls (DND set/cancel), we recommend establishing buttons for both FWD/DND—Outside calls and FWD/DND—Intercom calls, because:
  - a. the light patterns of the FWD/DND—Both calls button (including FWD/DND button [fixed button]) will indicate the setting for either outside calls or intercoms calls, but not both.

#### **Note**

The DND icon on PS display reflects the setting for outside calls only.

- b. pressing the FWD/DND—Both calls button (including FWD/DND button [fixed button]) will not change the FWD or DND mode for intercom calls and outside calls separately.



### Customising Your Phone

- 3.1.3 Customising the Buttons  
Create or edit FWD/DND (Both calls, Outside calls, Intercom calls) buttons.

## ◆◆ Switching FWD/DND Status Using Fixed FWD/DND Button

Using a proprietary telephone (PT) or KX-UT series SIP phone (except KX-UT670), you can easily switch the FWD/DND status for outside/intercom calls without clearing any FWD destination that was set previously.





- For KX-UT670 SIP phone users: There is no physical FWD/DND button on the phone. To set and clear the FWD/DND status, refer to the documentation for your phone.

**To switch the FWD/DND status for outside calls**

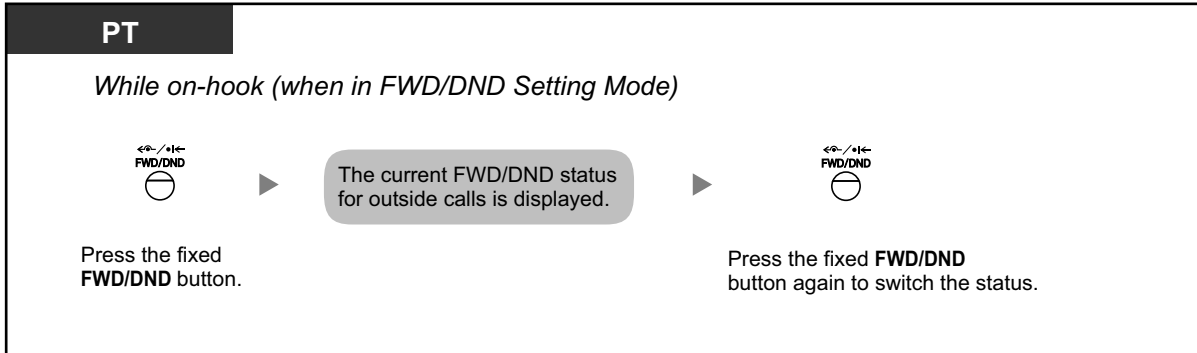

**To switch the FWD/DND status for intercom calls**

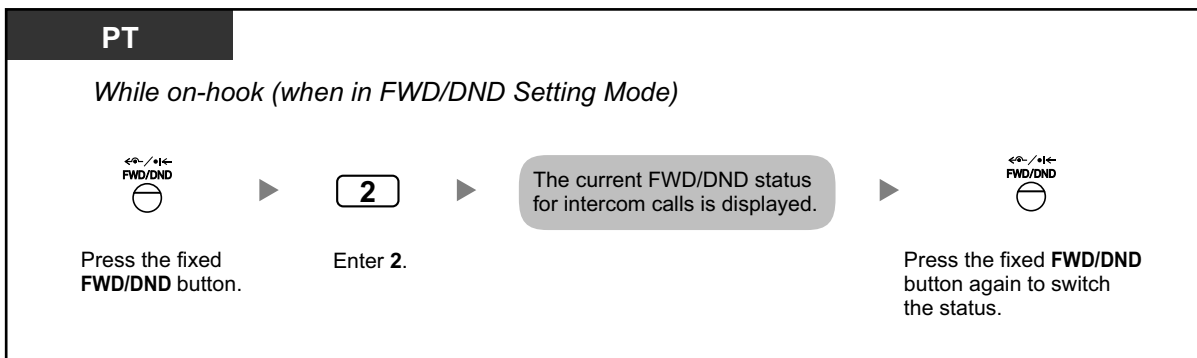

**To set and clear FWD/DND for outside/intercom calls**

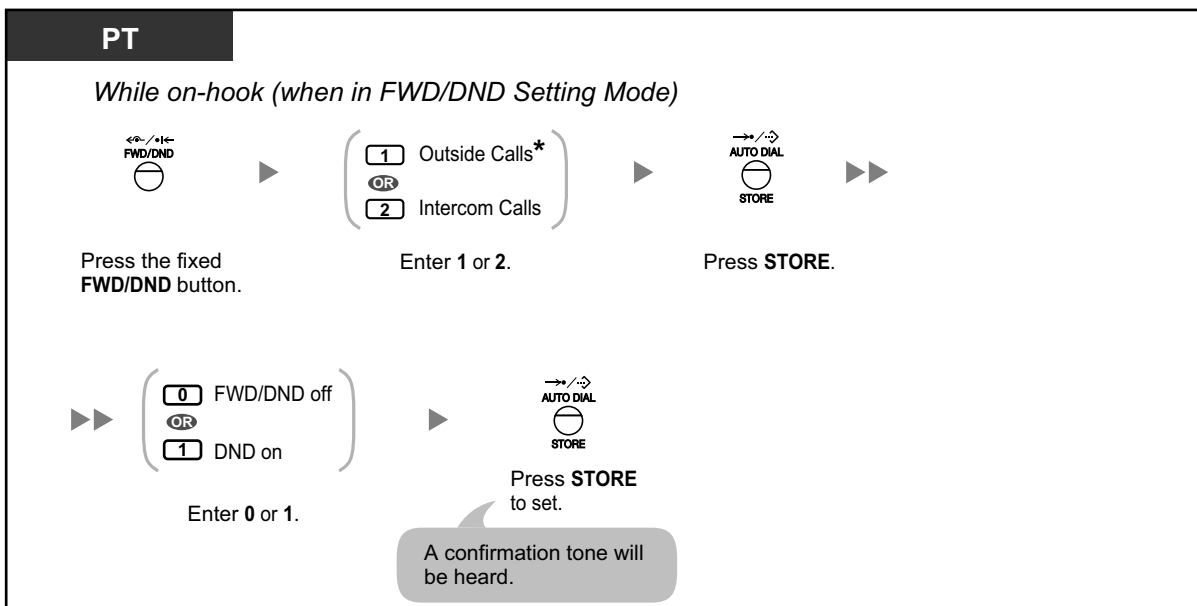

## 1.9.2 Refusing Incoming Calls (Do Not Disturb [DND])

---



- \* This step can be omitted.

### To set and clear FWD/DND for all calls

**KX-UT113/KX-UT123/KX-UT133/KX-UT136/KX-UT248**

*While on-hook*



Press the fixed  
**FWD/DND** button.

FWD/DND Off : FWD/DND off  
**OR**  
Do Not Disturb : DND on

Press **UP** or **DOWN** with  
the Navigator Key  
to select the desired item.



Press **ENTER** to set.

A confirmation tone will  
be heard.



## 1.9.3 Receiving Call Waiting (Call Waiting/Off-hook Call Announcement [OHCA]/Whisper OHCA)

During a conversation, you can be informed of a call waiting with a tone or voice announcement through your built-in speaker or handset. (Default: Disable—No call [Intercom calls]/No tone [Outside calls])

### Call Waiting Tone:

a waiting tone through the built-in speaker of PT/handset of SLT. To change the tone from PT, refer to "3.1.2 Settings on the Programming Mode".

### OHCA:

a voice announcement through the built-in speaker

### Whisper OHCA:

a voice announcement through the handset

### To set/cancel for intercom calls (Manual Call Waiting)

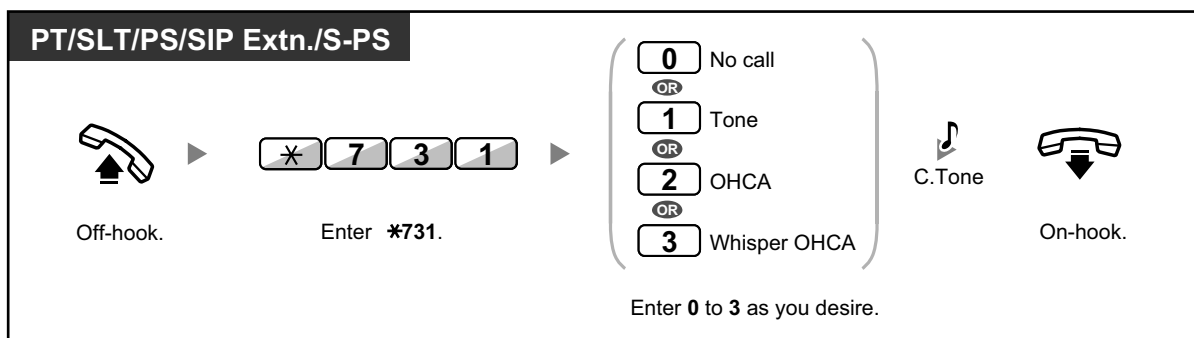

### To set/cancel for outside calls (Automatic Call Waiting)

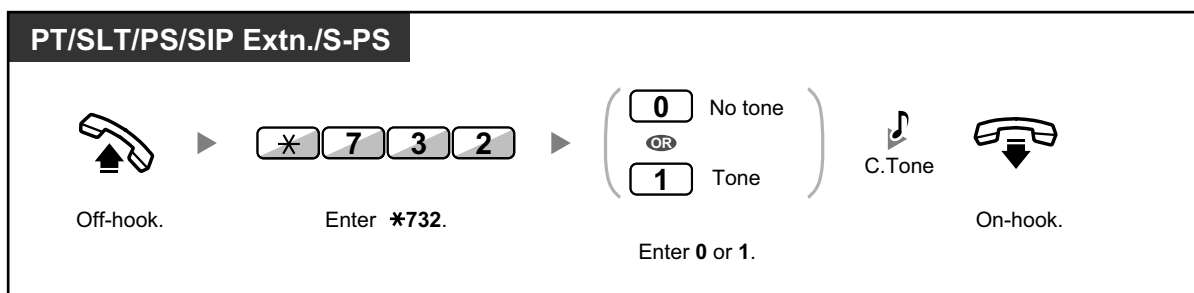

- OHCA is only available with certain digital proprietary telephones.
- Whisper OHCA is only available with certain digital proprietary telephones and IP proprietary telephones. In addition, both you and the other party must use supported telephones.

## 1.9.4 Displaying Your Telephone Number on the Called Party and Caller's Telephone (Calling/Connected Line Identification Presentation [CLIP/COLP])

### CLIP:

When making an outside call, you can present your preprogrammed telephone number to the called party.

### COLP:

When receiving an outside call, you can present your preprogrammed telephone number to the calling party.

You can select the telephone number sent, either the number of the line used or the number assigned to your extension.

If you select "Public", the calling/called party sees the number of the line used (subscriber's number).

If you select "Your extension", they see the telephone number assigned on your extension.

### To show either the number assigned to the outside line or your extension

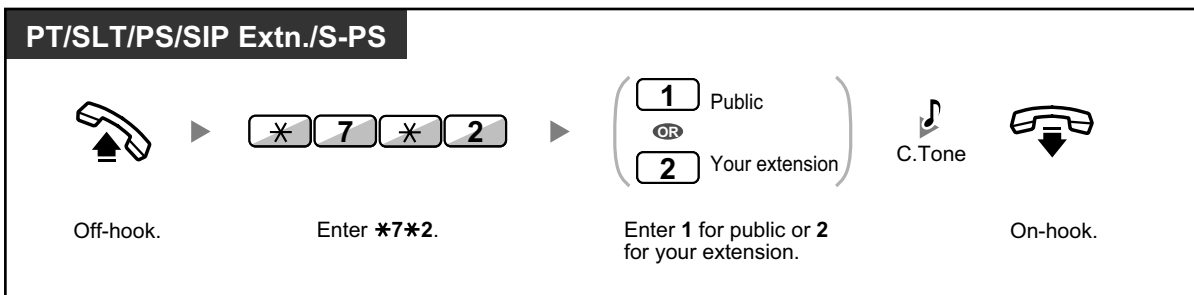

- Availability of this feature depends on the ISDN service of your telephone company.
- When you forward a call to an outside party, the CLIP number for that call will be that of the calling party or of the forwarding extension depending on system programming.



- If you use the ICD Group button to make a call to the other party, the telephone number assigned to the ICD Group will be used.

## 1.9.5 Preventing Your Telephone Number Being Displayed on the Caller's Telephone (Connected Line Identification Restriction [COLR])

When receiving an outside call, you can select whether the caller can see your telephone number or not.

### To show/prevent

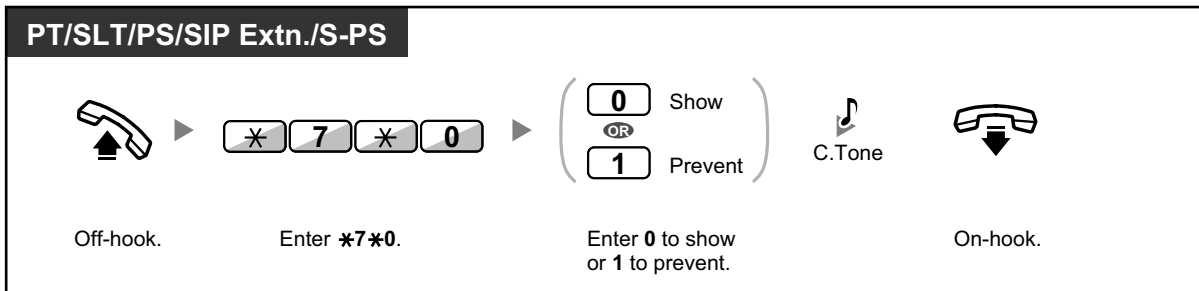

- You can change the mode by pressing a preset COLR button while on-hook (There is no COLR button on KX-UT series SIP phones).  
The COLR button light shows the current status as follows:  
**Off:** shows your telephone number.  
**Red on:** prevents your telephone number being displayed.
- Availability of this feature depends on the ISDN service of your telephone company.



### Customising Your Phone

- 3.1.3 Customising the Buttons  
Create or edit a Connected Line Identification Restriction (COLR) button.

## 1.9.6 Preventing Your Number Being Displayed on the Called Party's Telephone (Calling Line Identification Restriction [CLIR])

When making an outside call, you can select whether the called party can see your telephone number or not.

### To show/prevent

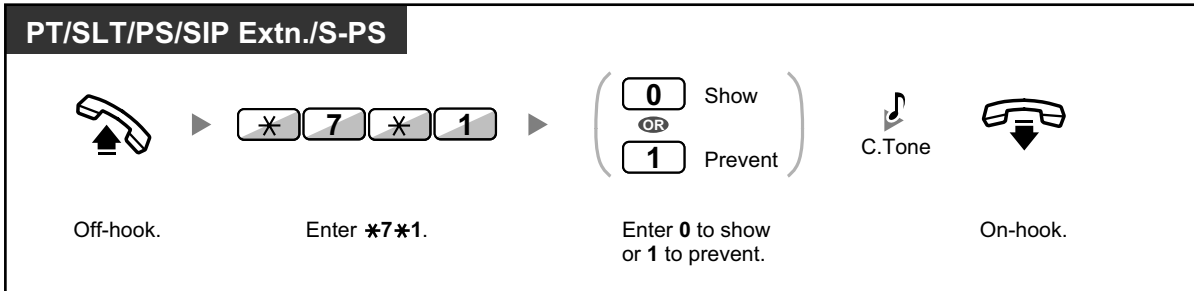

- You can change the mode by pressing a preset CLIR button while on-hook (There is no CLIR button on KX-UT series SIP phones).  
The CLIR button light shows the current status as follows:  
**Off:** shows your telephone number.  
**Red on:** prevents your telephone number being displayed.
- Availability of this feature depends on the ISDN service of your telephone company.



### Customising Your Phone

- 3.1.3 Customising the Buttons  
Create or edit a Calling Line Identification Restriction (CLIR) button.

## 1.9.7 Preventing Other People from Joining Your Conversation (Executive Busy Override Deny)

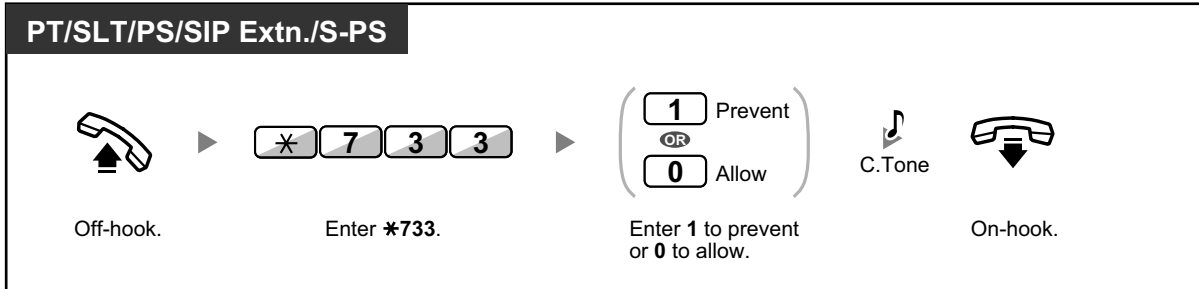

- Some extensions may be prohibited from performing this feature.

## 1.9.8 Turning on the Background Music (BGM)

You can listen to the background music through your telephone speaker while on-hook. An external music source, such as a radio, can be connected. If your extension becomes busy (off-hook, making or receiving a call etc.), the music stops temporarily. When you go back on-hook, the music starts again.



### To select and set/cancel

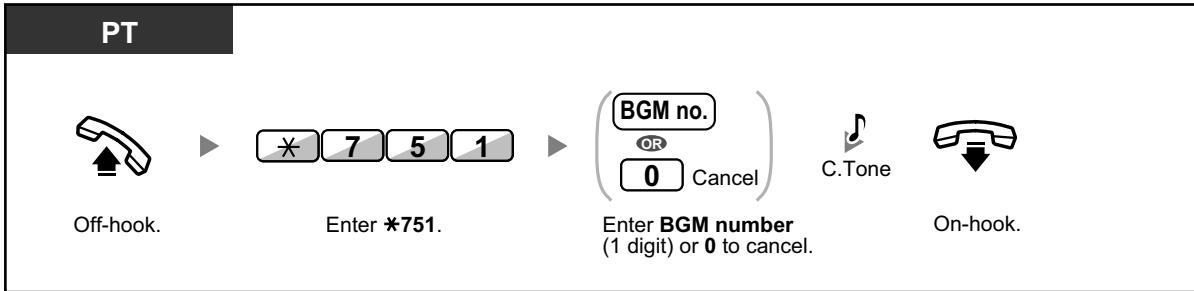

- System programming may be required for some IP-PT users to listen to background music.

## 1.9.9 Protecting Your Line against Notification Tones (Data Line Security)

You can protect the line against audible notification tones, such as a call waiting tone during a conversation. Set this feature if your extension has a data communication device, such as a PC or fax machine connected to ensure secure data transmission.

### To set/cancel

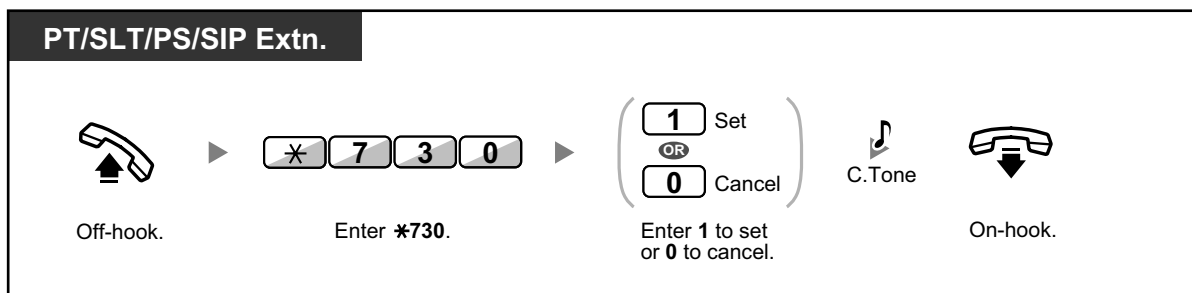

## 1.9.10 Checking the Time Service Status

You can check the current status of the Time Service on the display.

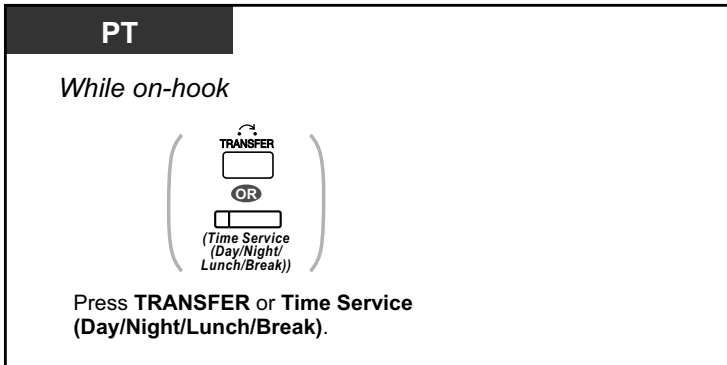

- The Time Service (Day/Night/Lunch/Break) button light shows the current status as follows:
  - Off:** Day mode
  - Green on:** Lunch mode
  - Flashing green:** Break mode
  - Red on:** Night mode
  - Flashing red:** Holiday mode
- Any extension user except the managers can check the current status by pressing the Time Service (Day/Night/Lunch/Break) button.



### Customising Your Phone

- 3.1.3 Customising the Buttons
  - Create or edit a Time Service (Day/Night/Lunch/Break) button.



## 1.9.11 Setting the Paralleled Telephone to Ring (Paralleled Telephone)

In the case where a single line telephone is connected in parallel to your digital proprietary telephone, you can choose whether the paralleled single line telephone will ring to an incoming call or not.  
(Default: Ring)

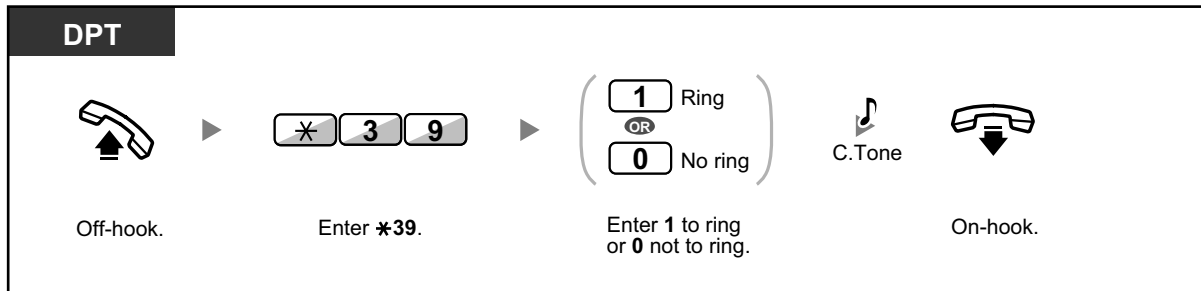







- **Even if "No ring" is selected**, calls can be made and answered on the single line telephone by lifting the handset.
- **If you go off-hook while your paralleled telephone is in use**, the call will switch over to you.
- This feature is not available for the KX-T7665.

## 1.9.12 Using Your PS or S-PS in Parallel with a Wired Telephone (Wireless XDP Parallel Mode)

Your PS or S-PS can be used in parallel with a PT, SLT, or SIP phone. When in this mode, incoming calls to a wired telephone also ring the paired PS or S-PS.

### To set

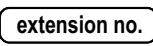





**PS/S-PS**

 ▶    ▶  ▶   

Press **TALK**.      Enter **\*48**.      Enter **1**.      Enter **extension number** of the paired telephone.      Press **CANCEL**.

### To cancel

**PS/S-PS**

 ▶    ▶   

Press **TALK**.      Enter **\*48**.      Enter **0**.      Press **CANCEL**.



- Some wired telephones are prohibited from using this feature.
- **If you go off-hook while your paralleled telephone is in use**, the call will switch over to you (except SIP phones and S-PSs).

## 1.9.13 Using Your phone in Parallel with a Wired Telephone (One-numbered extension)

Two telephones connected to the KX-NS300 can be set to share 1 extension number, and both telephones can be set to ring (One-numbered Extension feature). You can choose whether the sub extension associated with the main extension will ring when an incoming call is received.

### To set

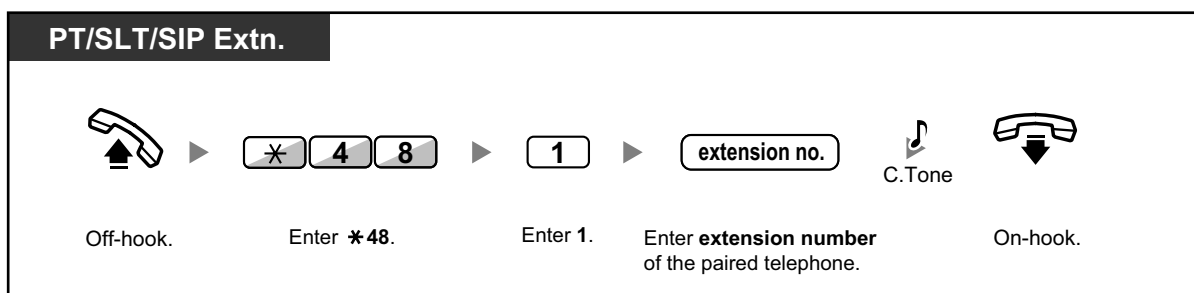

### To cancel

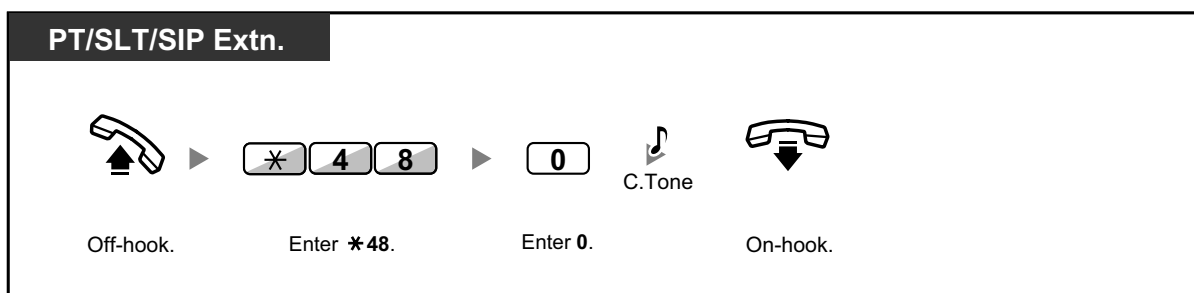

### To pickup call during conversation

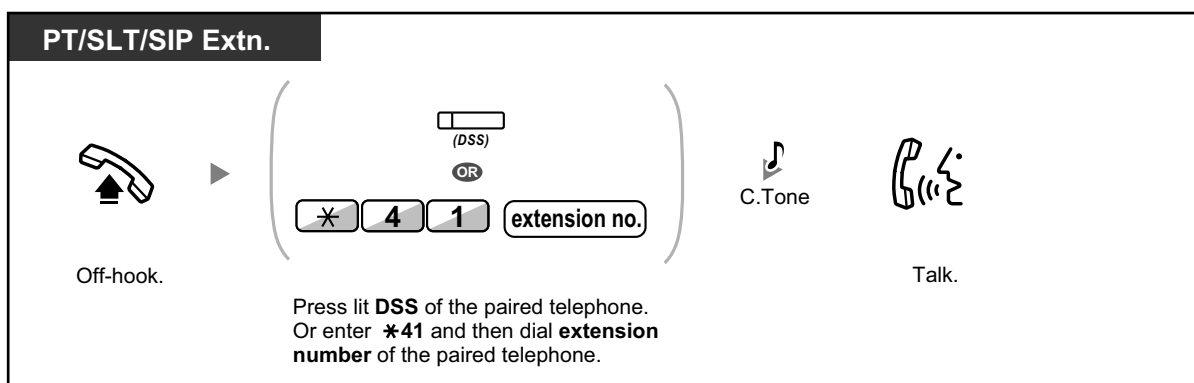

## 1.9.14 Clearing Features Set at Your Extension (Extension Feature Clear)

You can reset the settings of the following features on your extension to the default settings with one operation.

This feature is also known as Station Programme Clear.



- For KX-UT series SIP phone users: You can reset the settings of the following features on your extension.
  - Message Waiting
  - Call Forwarding (FWD)
  - Timed Reminder
  - Do Not Disturb (DND)
  - Call Waiting for intercom calls
  - Call Waiting for outside calls
  - Data Line Security
  - Log-in/Log-out

Features	Default Setting
Hot Line <sup>*1</sup>	<b>Off</b>
Message Waiting—(All the messages that have been left by other extension users)	<b>Off</b>
Call Pickup Deny	<b>Allow</b>
Call Forwarding (FWD) <sup>*1</sup>	<b>Off</b>
Absent Message	<b>Off</b>
Paging Deny	<b>Allow</b>
Timed Reminder	<b>Cleared</b>
Do Not Disturb (DND) <sup>*1</sup>	<b>Off</b>
Call Waiting for intercom calls <sup>*1</sup> Call Waiting for outside calls <sup>*1</sup>	<b>Disable (No call)</b> <b>Disable (No tone)</b>
Executive Busy Override Deny	<b>Allow</b>
BGM	<b>Off</b>
Data Line Security	<b>Off</b>
Paralleled Telephone	<b>The telephone in parallel rings.</b>
Log-in/Log-out	<b>Log-in</b>

<sup>\*1</sup> These features may not be reset depending on the system programming.

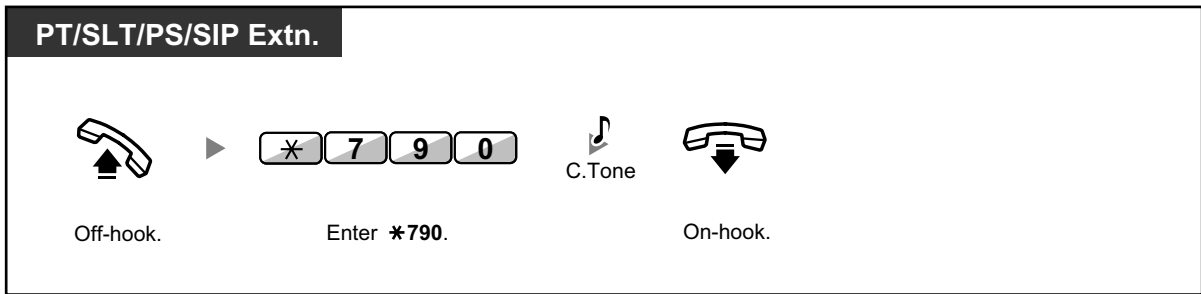

- For Users in Canada Only:  
After performing Extension Feature Clear, the setting of Call Waiting becomes "Enable (Tone)". In this case, dial tone 2 will be heard when you go off-hook.

# 1.10 Utilising the Call Centre

## 1.10.1 Leaving an Incoming Call Distribution Group (Log-in/Log-out, Wrap-up)

You can control your status in an incoming call distribution group. When in the Log-out mode, incoming calls to the group will not ring at your extension. When you return, calls will again ring at your extension. (Default: Log-in) Even if your extension is logged-in, you can have a specified time period (wrap-up time) when you will not receive calls after completing a previous call. This time can be used for you to write a report and so on. You can also manually select "Not Ready" mode to temporarily leave a distribution group.

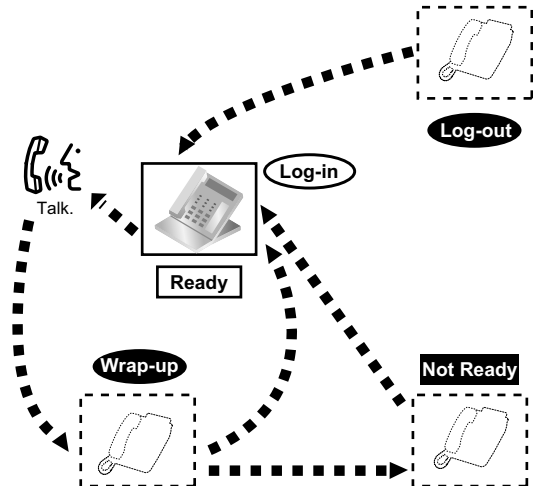

### To set Log-in/Log-out

PT/SLT/PS/SIP Extn./S-PS	<i>ICD Group: Incoming Call Distribution Group</i>	
		<div style="border: 1px solid black; padding: 5px; display: inline-block;"> <span style="font-size: 24px; margin-right: 5px;">0</span> Log-out  <span style="font-size: 18px; margin-right: 5px;">OR</span>  <span style="font-size: 24px; margin-right: 5px;">1</span> Log-in                 </div>
Off-hook.	Enter *736.	Enter 0 or 1.
<div style="border: 1px solid black; padding: 5px; display: inline-block;">                     ICD Group extension no.  <span style="font-size: 18px; margin-right: 5px;">OR</span>                      *                 </div>	<div style="border: 1px solid black; padding: 5px; display: inline-block;">                     Specified  <span style="font-size: 18px; margin-right: 5px;">OR</span>                      All                 </div>	 C.Tone  
Enter ICD Group extension number or *.		On-hook.

**PT/PS**

*ICD Group: Incoming Call Distribution Group*  
*While on-hook*

Press **Log-in/Log-out**. Enter ICD Group extension number or \*.

**KX-UT133/KX-UT136/KX-UT248/KX-UT670/S-PS**

*While on-hook*

Press **Log-in/Log-out for all groups** or **Log-in/Log-out of a specified group**.

**PT/PS**

*While on-hook*

Press **Log-in/Log-out of a specified group**.

**To enter/leave Not Ready mode**

**PT/SLT/PS/SIP Extn./S-PS**

Off-hook. Enter \* 735. Enter 1 or 0. On-hook.

To set/cancel Not Ready mode or to leave Wrap-up mode (To enter Ready mode)

PT/PS/KX-UT133/KX-UT136/KX-UT248/KX-UT670/S-PS

*While on-hook*



Press red or flashing red **Wrap-up**.\*



- \* The status will be as follows:  
Ready → Not Ready  
Not Ready → Ready  
Wrap-up → Not Ready
- The Log-in/Log-out of a specified group button light shows the current status as follows:  
**Off:** Log-in mode  
**Red on:** Log-out mode
- The Wrap-up button alternates the setting of Wrap-up mode, Not Ready mode or Ready mode.  
The Wrap-up button light shows the current status as follows:  
**Off:** Ready mode  
**Red on:** Not Ready mode  
**Flashing red:** Wrap-up mode
- In Wrap-up mode/Not Ready mode, your extension does not receive calls through any group, even if it belongs to multiple groups.
- The last remaining logged-in extension may not be allowed to log out, depending on system programming.
- The Supervisor extension can control the Log-in/Log-out status of other extensions. For more information, refer to "1.10.2 Monitoring and Controlling the Call Status of an Incoming Call Distribution Group (Incoming Call Distribution Group Monitor)".



**Customising Your Phone**

- 3.1.3 Customising the Buttons  
Create or edit a Log-in/Log-out button, a Log-in/Log-out of a specified group button or a Wrap-up button.



## 1.10.2 Monitoring and Controlling the Call Status of an Incoming Call Distribution Group (Incoming Call Distribution Group Monitor)

- ◆◆ Monitoring the Status of Waiting Calls
- ◆◆ Monitoring and Changing the Log-in/Log-out Status of Extensions

The extension assigned as a Supervisor extension can monitor and control the status of other extensions in an incoming call distribution group. It should have a PT with 6-line display. The display and DSS buttons show as follows:

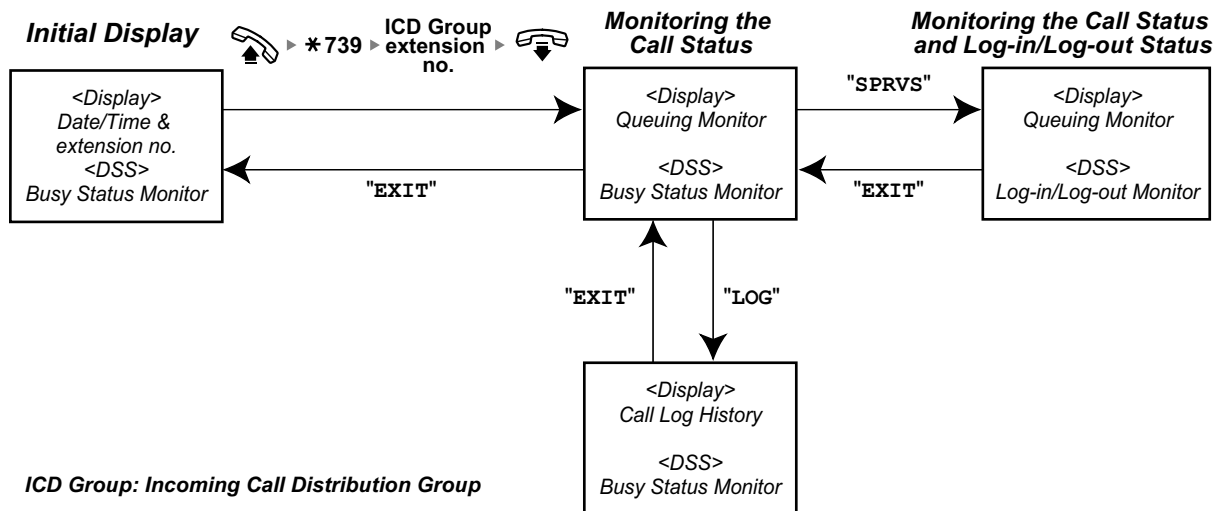

### ◆◆ Monitoring the Status of Waiting Calls

The Supervisor extension can monitor the status of calls waiting to be answered in the queue. If an incoming call distribution group has an overflowed call, the display shows the status automatically. The following information is displayed.

#### <Queuing Monitor>

- The current date/time
- The ICD Group extension number/name
- The number of waiting calls
- The longest waiting time

#### <Call Log History>

- The date/time when cleared at last time
- The total number of received calls
- The number of overflowed calls
- The number of unanswered calls
- The average waiting time of queuing calls

To monitor

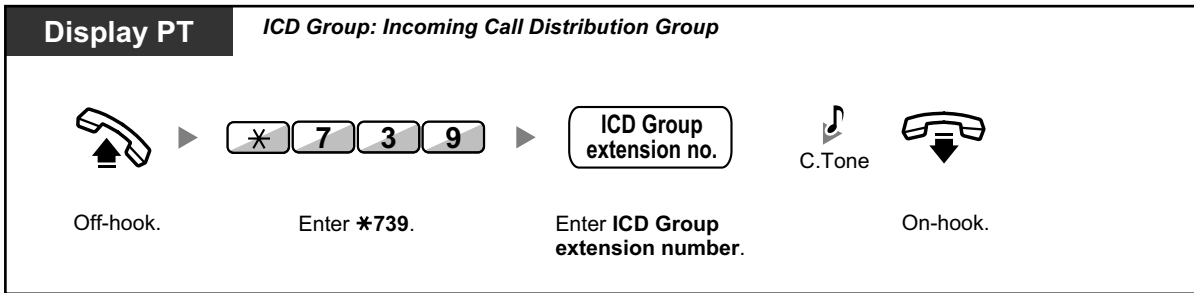

To clear Call Log History



- The accumulated data is cleared. "\*\*\*\*\*" shows if the number to be displayed exceeds the maximum displayable digits.

◆◆ Monitoring and Changing the Log-in/Log-out Status of Extensions

The Supervisor extension can monitor the Log-in/Log-out status of the incoming call distribution group members by the DSS button light. It can also change their Log-in/Log-out status if needed.

To monitor

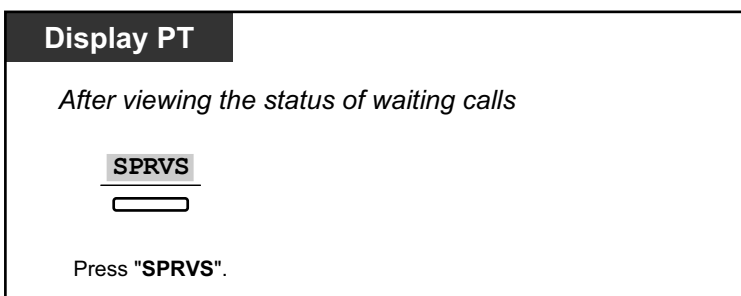

### To change the Log-in/Log-out mode



- The DSS button light shows the current status as follows:
  - Off:** The extension is not in the group.
  - Green on:** Log-in (Ready) mode
  - Flashing green:** Log-in (Not Ready) mode
  - Red on:** Log-out mode

## 1.10.3 Forwarding a Waiting Call (Manual Queue Redirection)

When your incoming call distribution group is busy and other outside calls arrive, the arriving calls are put in a waiting queue. Extensions can check the status of the queue with the Hurry-up button light, and forward the longest waiting call in the queue to a preset destination manually. This feature is also known as Hurry-up Transfer.



### To forward the waiting call

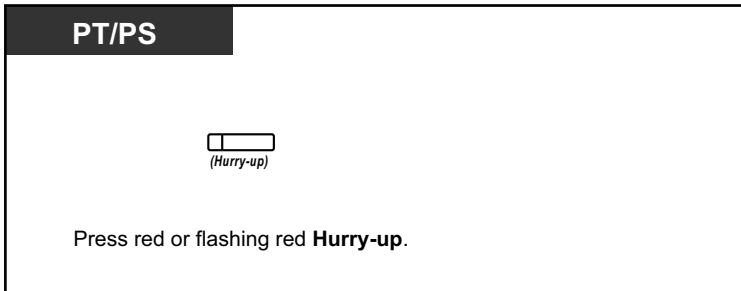

- The Hurry-up button light shows the current status as follows:
  - Off:** No waiting call.
  - Red on:** Some calls are waiting.
  - Flashing red:** The number of calls exceeds the manual queue redirection level.



### Customising Your Phone

- 3.1.3 Customising the Buttons
  - Create or edit a Hurry-up button.

## 1.11 Using User-supplied Equipment

### 1.11.1 If a Doorphone/Door Opener is Connected

You can talk to a person at the door through the doorphone. Preprogrammed extensions or an outside party can receive the calls from the doorphone. You can open the door.

- ◆◆ Doorphone Call
- ◆◆ Opening a Door (Door Open)

#### ◆◆ Doorphone Call

##### To call from the doorphone

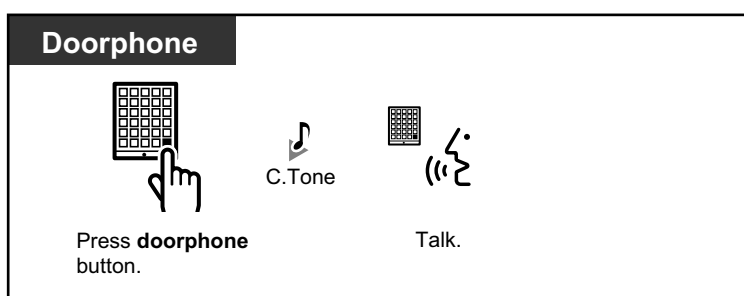

##### To answer a call from the doorphone



- For KX-UT series SIP phone and S-PS users: If the doorphone number and name are stored in the phonebook of your phone, the doorphone information is displayed on your phone when a call arrives from the doorphone.
- For KX-UT670 SIP phone users: The video feed from a network camera can be displayed on your phone's display when a call arrives from a doorphone and the following settings are configured on your phone:
  - The network camera is registered to a contact.
  - The doorphone number is registered to the contact, and "Doorphone" is selected as the label for the phone number.

For details about the settings, refer to the documentation for your phone.

### To call the doorphone

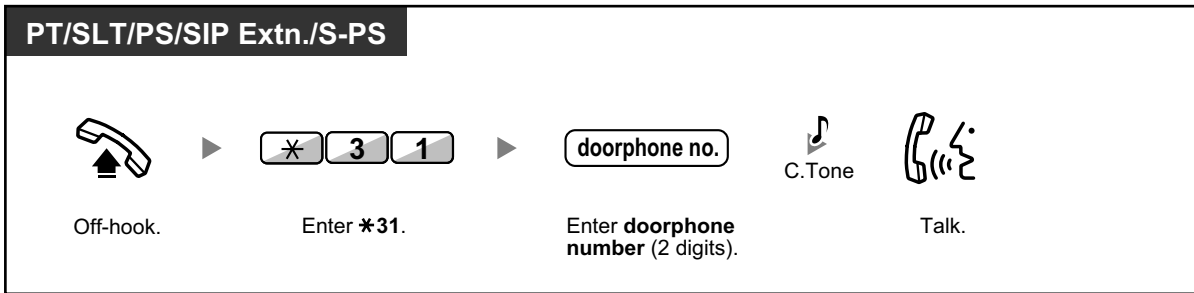

- If no one answers a doorphone call within a specified time period, the call is cancelled.

### ◆◆ Opening a Door (Door Open)

Some extensions may be prohibited from using this feature.

#### From a specified extension

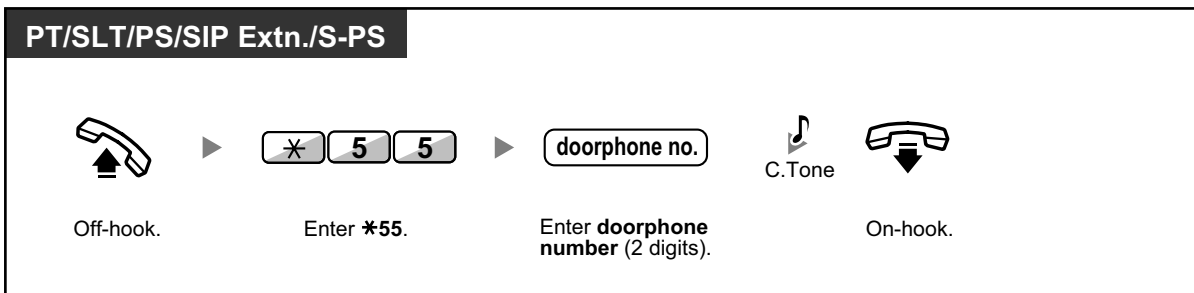

#### From any extension while talking to the doorphone



- The door open will be triggered for a specified time period.

## 1.11.2 If an External Relay is Connected

Preprogrammed extensions can switch on a relay (e.g., alarm) connected to the PBX.

### To switch on the relay



- The relay will be switched off after a specified time period.

## 1.11.3 If an External Sensor is Connected

Preprogrammed extensions can receive an alert call from an external sensor (e.g., security alarm) connected to the PBX.

### To answer a sensor call



- If you do not answer a sensor call within a specified time period, the sensor call will stop.



## 1.11.4 If a Host PBX is Connected

- ◆◆ Accessing External Services (External Feature Access [EFA])

### ◆◆ Accessing External Services (External Feature Access [EFA])

You can access special features (e.g., Call Waiting) offered by a host PBX or telephone company. This feature is only effective for an outside call.

<Example> To hold the current call and then talk to the new party

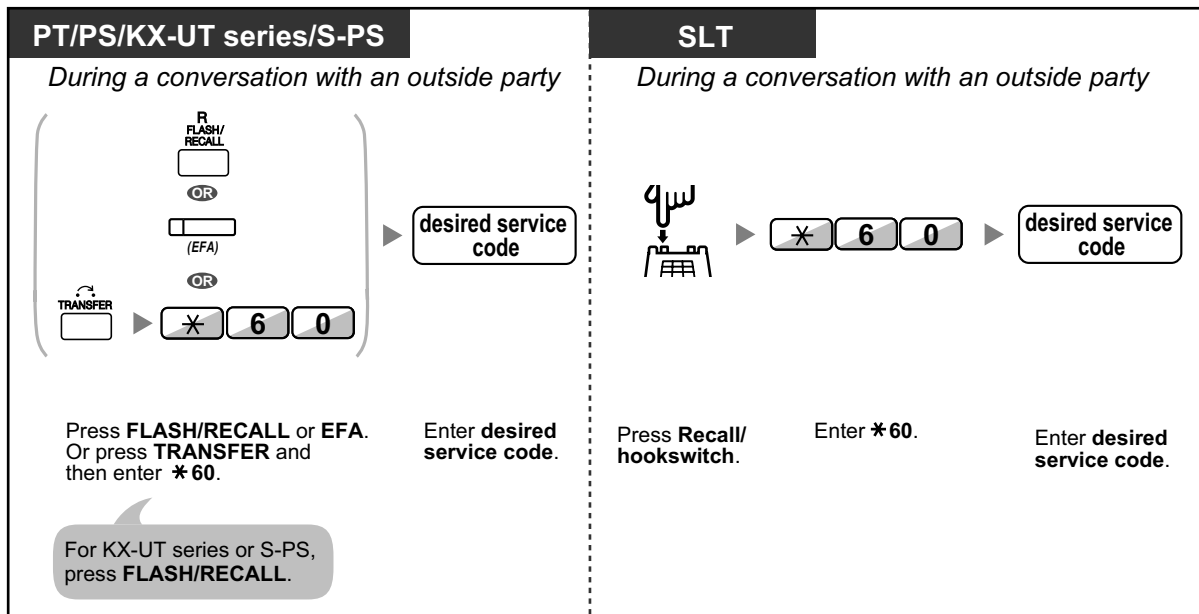

- In this case, the FLASH/RECALL button on a proprietary telephone, KX-UT series SIP phone, or S-PS must be set to External Feature Access (EFA) mode through system programming.



### Customising Your Phone

- 3.1.3 Customising the Buttons  
Create or edit an External Feature Access (EFA) button.

## 1.11.5 If a Voice Processing System is Connected

You or an outside party can access the Voice Processing System from a telephone.

- ◆◆ Call Forwarding to Voice Mail (Voice Mail Integration)

If your PBX has a Panasonic Voice Processing System connected (e.g., KX-TVM series) using digital integration, the following features are also available:

- ◆◆ Screening Calls (Live Call Screening [LCS])
- ◆◆ Recording a Conversation



- Voice Processing System features are not available for SIP phone and S-PS users.

### ◆◆ Call Forwarding to Voice Mail (Voice Mail Integration)

- To forward your calls to your mailbox
- To transfer a call to a mailbox
- To listen to messages

If you cannot answer calls, you can forward them to your mailbox. You can select the type of incoming calls (Intercom Calls/Outside Calls/Both Calls) that are forwarded.

If your telephone has a Message button, the Message light turns on when a message is left in your mailbox. You will hear an indication tone\* when going off-hook, regardless of whether or not your telephone has a Message button.

You can also create a Voice Mail Transfer button on your phone to transfer received outside calls to a mailbox of another extension so that calling parties can leave messages (Voice Mail Transfer). The duration for recording depends on the Voice Processing System. Using the Voice Mail Transfer button, you can also perform the following operations with one touch (for digital integration only):

- To forward a call to your mailbox while it is ringing
- To transfer your own call to the called extension's mailbox
- To listen to messages

**To forward your calls to your mailbox**

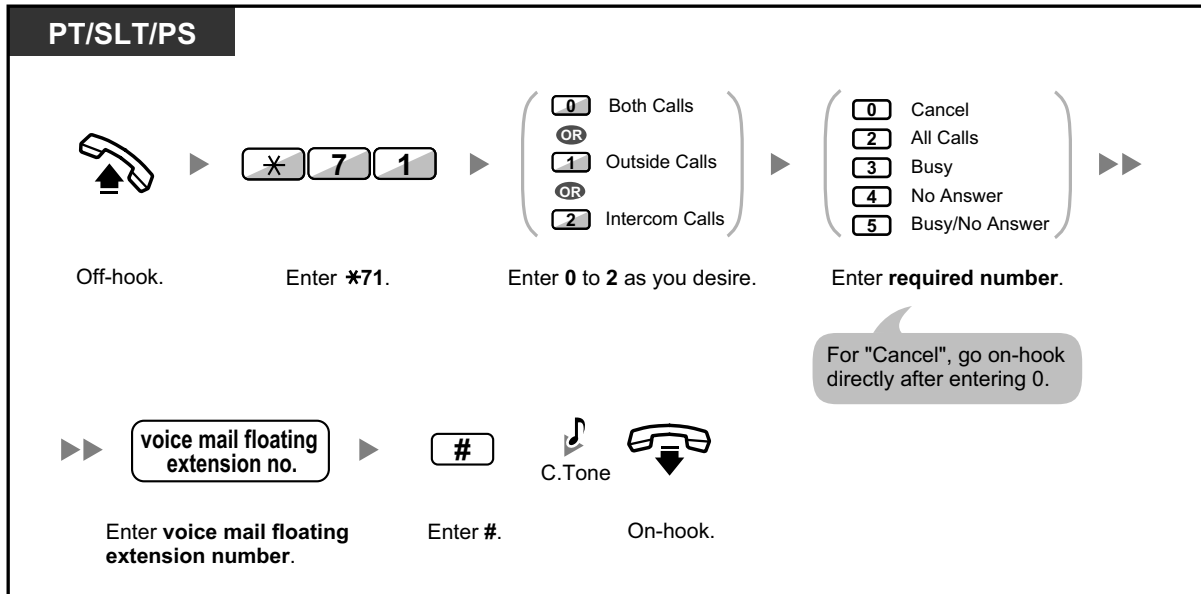

**To forward a call to your mailbox while it is ringing**

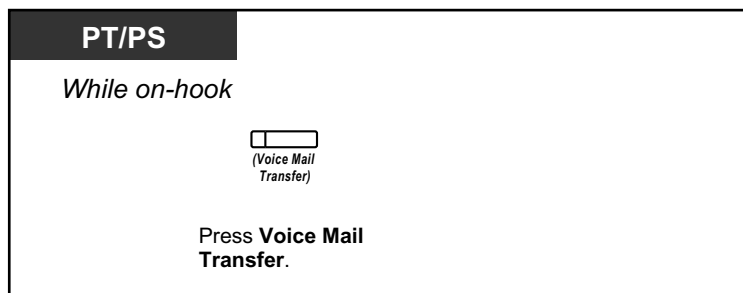

**To transfer a call to a mailbox**

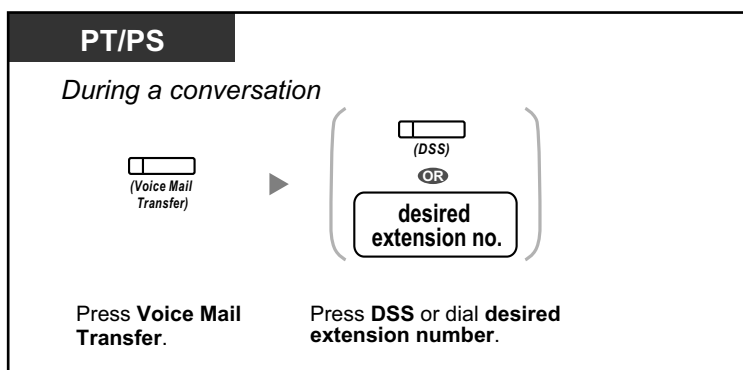

**To transfer your own call to the called extension's mailbox**

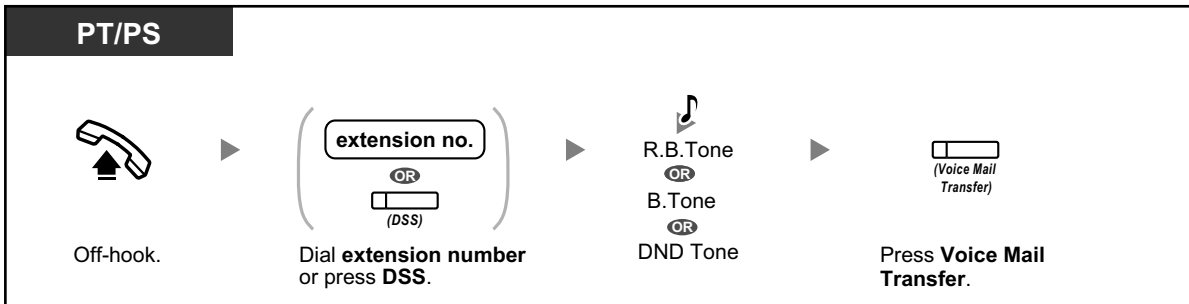

**To listen to messages**

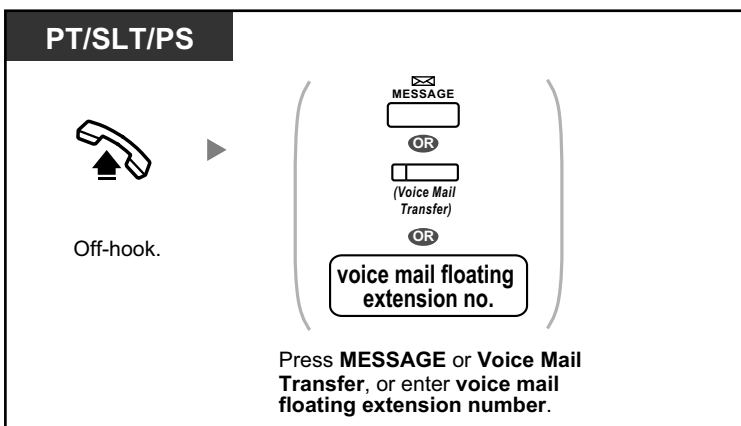

- \*Indication tone after going off-hook



- If using a PS in parallel with a PT or SLT (in Wireless XDP Parallel mode), you cannot use the Voice Mail Transfer button to forward a call to your mailbox while it is ringing.



**Customising Your Phone**

- 3.1.3 Customising the Buttons  
Create or edit a Voice Mail Transfer button or a Message button.

**Screening Calls (Live Call Screening [LCS])**

While a caller is leaving a message in your mailbox, you can monitor the call without answering. If you so desire, you can answer the call while monitoring. There are two methods available (Default: Hands-free mode).



**Hands-free mode:**

You can monitor the message automatically, live through the telephone speaker.

**Private mode:**

You will hear an alarm tone while the caller is leaving a message.

**Before operating**

- Create a Live Call Screening (LCS) button (Personal Programming).
- Select the mode, either Hands-free or Private (Personal Programming).
- Set the extension PIN (Personal Identification Number).
- Set the Live Call Screening feature.

**To set Live Call Screening**

**PT/PS** *PIN: Personal Identification Number*

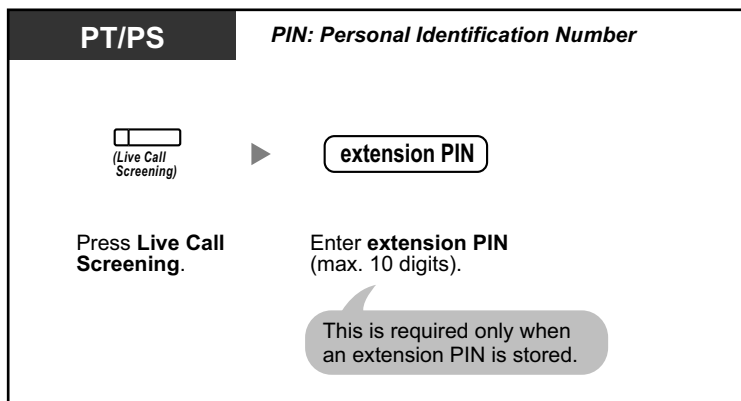

**(Live Call Screening)**

Press **Live Call Screening**.

**extension PIN**

Enter **extension PIN**  
(max. 10 digits).

This is required only when  
an extension PIN is stored.

**To cancel Live Call Screening**

**PT/PS**

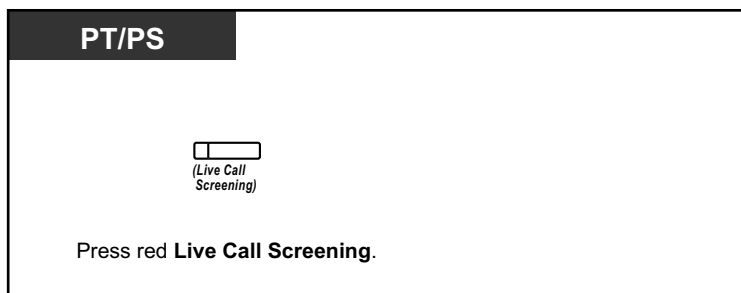

**(Live Call Screening)**

Press red **Live Call Screening**.

### Operation Flowchart

The operations in the shaded areas can be done hands-free.

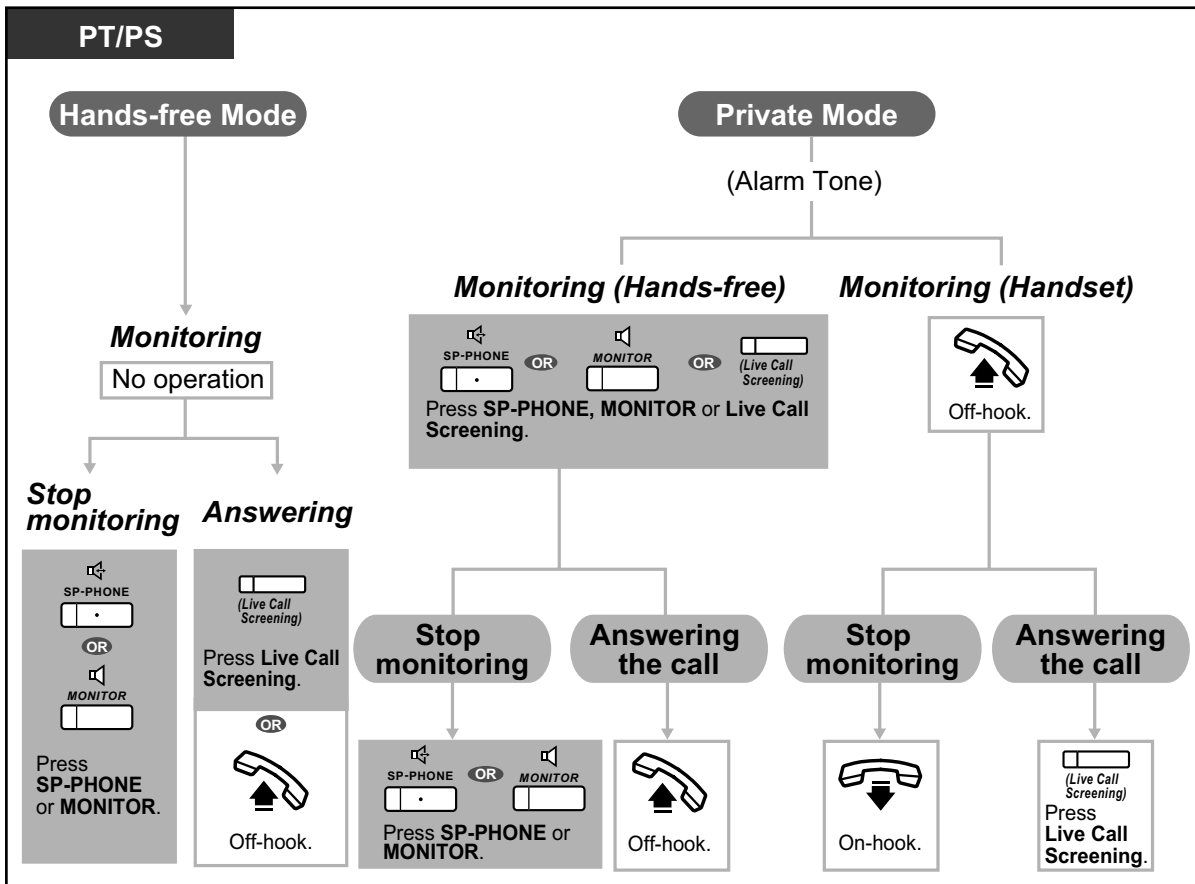

- The Live Call Screening (LCS) button light shows the feature status as follows:
  - Off:** LCS is off.
  - Flashing green rapidly:** Alerting in the Private mode.
  - Flashing green slowly:** Monitoring.
  - Red on:** LCS is on.
- The manager extension can clear an extension PIN.
- This feature is available for a single line telephone if it is connected to a proprietary telephone in parallel. (Private mode only)
  - To answer the call while monitoring, press Recall/hookswitch.
- Only the handset monitoring in the Private mode is available for PS users.



### Customising Your Phone

- 3.1.2 Settings on the Programming Mode—**Live Call Screening Mode Set**
  - Select the mode, either monitoring the message through the speaker automatically or receiving, while the caller leaves a message.
- 3.1.3 Customising the Buttons
  - Create or edit a Live Call Screening (LCS) button.

## ◆◆ Recording a Conversation

You can record a conversation into a mailbox while talking on the phone.  
You can select the mailbox each time you record a conversation.



### To record into your mailbox (Two-way Record)

**PT/PS**

*During a conversation*

 (Two-way Record)

To stop recording, press this button again.

Press **Two-way Record**.

### To record into another mailbox (Two-way Transfer)

**PT/PS**

*During a conversation*

 (Two-way Transfer)

Press **Two-way Transfer**.

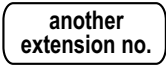
 (DSS)  
OR  
 another extension no.

Press **DSS** or enter another extension number.

To stop recording, press this button again.

### To record into another mailbox with one touch (One-touch Two-way Transfer)

**PT/PS**

*During a conversation*

 (One-touch Two-way Transfer)

Press **One-touch Two-way Transfer**.



- The Two-way Record button light, Two-way Transfer button light or One-touch Two-way Transfer button light shows the current status as follows:  
**Off:** Not recording.  
**On:** Recording the conversation.



- **Note:**  
When you record your Two-way telephone conversations, you should inform the other party that the conversation is being recorded.



#### **Customising Your Phone**

- 3.1.3 Customising the Buttons  
Create or edit a Two-way Record button, a Two-way Transfer button and a One-touch Two-way Transfer button.



## 1.12 Administrative Features

### 1.12.1 Using the Telephones in a Hotel-type Environment (Hospitality Features)

In a hotel-type environment, an extension assigned as a hotel operator can be used to view and set the check-in/check-out/cleaned-up (Ready or Not Ready) status of each guest room extension. When the hotel operator presses a flexible button assigned as "Check-in", "Check-out", or "Cleaned-up" on his/her extension, the extension will switch to Room Status Control mode, and the light of the DSS button for each room extension will show the current room status. This allows the hotel operator to manage guests and rooms with just a telephone. In addition, the hotel operator can set automatic wake-up calls for guest rooms.



- ◆◆ Check-in
- ◆◆ Check-out
- ◆◆ Setting a Timed Reminder to a Room Extension (Remote Wake-up Call)
- ◆◆ Cleaned-up



- The hotel operator must be using a 6-line display PT to use the Check-in, Check-out, and Cleaned-up features.
- While in Room Status Control mode:
  - a. The hotel operator's extension can only check extensions in/out and ready/not ready. All other operations will be ignored.
  - b. The light of each DSS button shows the room status of the corresponding extension as follows:
    - Off:** Checked-out and Ready
    - Flashing Red:** Checked-out and Not Ready
    - Red on:** Checked-in
  - c. The lights of other buttons may not show their normal display.
  - d. The hotel operator's extension is considered to be busy. Callers to that extension will hear a busy tone.

#### ◆◆ Check-in

The hotel operator can change the room status of extensions to check-in by using the Check-in button assigned on his/her extension.

#### To check in

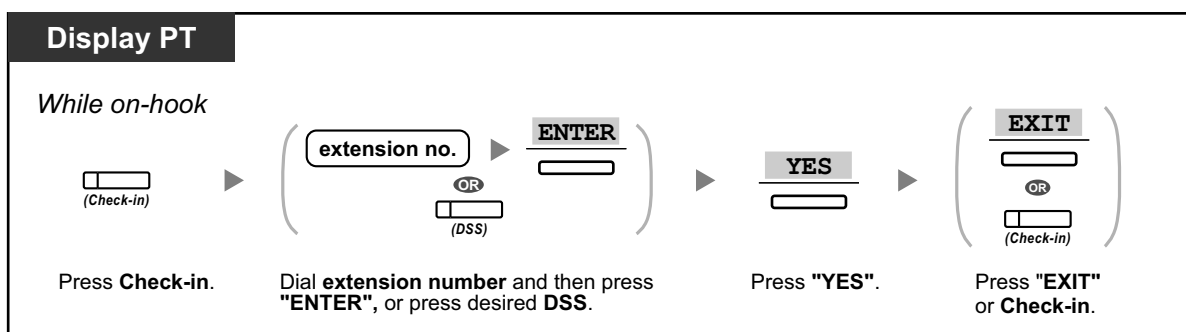

### 1.12.1 Using the Telephones in a Hotel-type Environment (Hospitality Features)



- After check-in, Remote Extension Dial Lock is deactivated, and the guest can make outside calls from the room extension. (Refer to "2.1.1 Extension Control".)
  - After check-in, all billing data previously charged to the extension will be cleared automatically.
  - When the room status of extensions is changed, detailed room status information is recorded automatically. This requires system programming.
- <Example>

Date	Time	Ext	CO	Dial Number
02/02/00	03:07PM	1234		Check in

### ◆◆ Check-out

The hotel operator can change the room status of extensions to check-out by using the Check-out button assigned on his/her extension.

Depending on the setting of the PBX, the hotel operator can do the following:

- Record/edit charges for Minibar/Others
- Print out an invoice containing charge information

#### To check out a room with/without printing an invoice

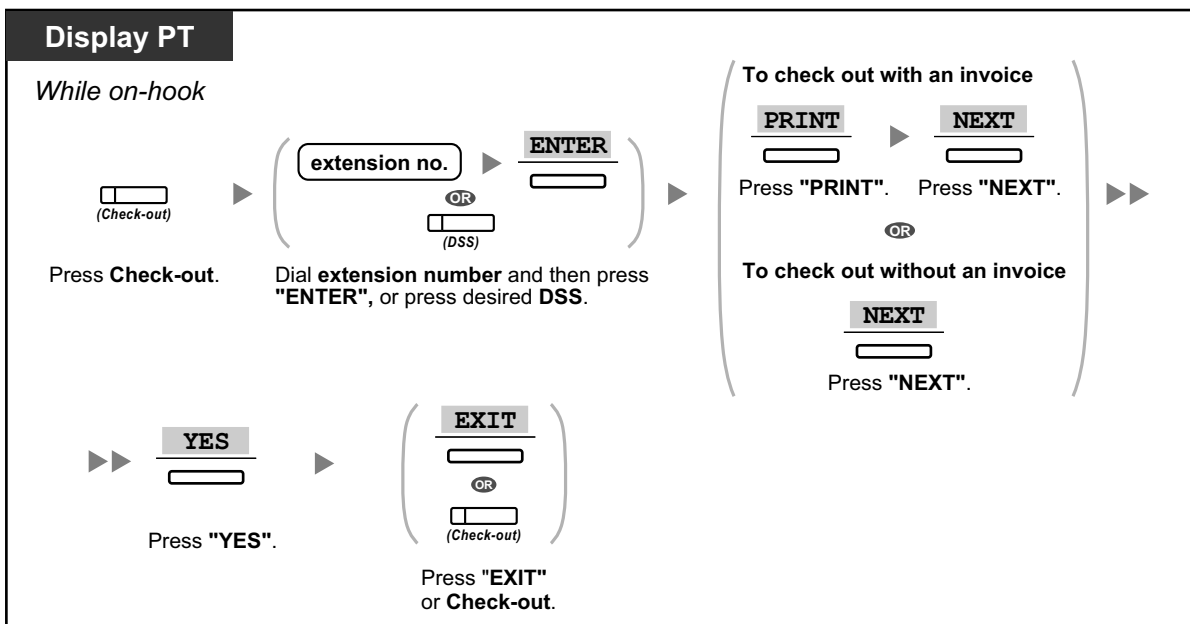

To record/edit room charges and check out a room with/without printing an invoice

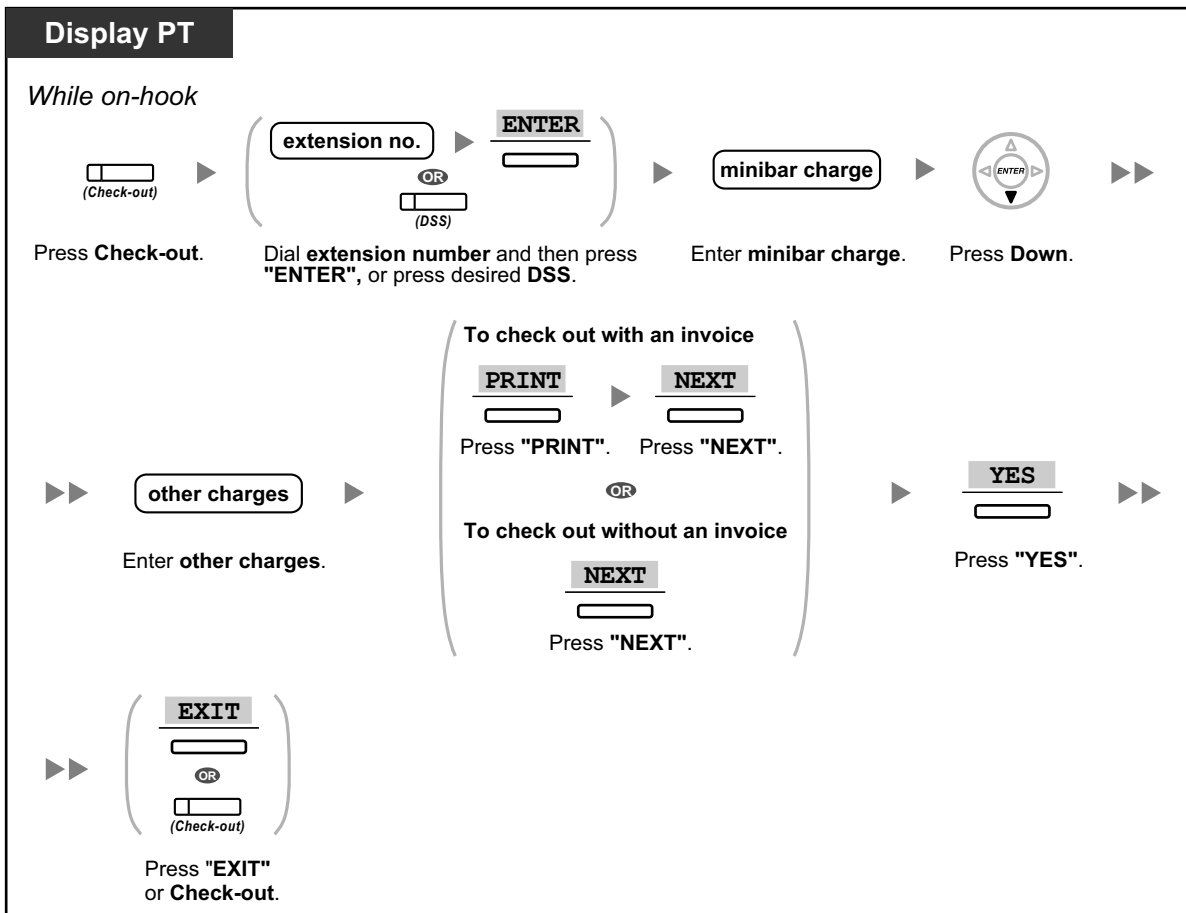

### 1.12.1 Using the Telephones in a Hotel-type Environment (Hospitality Features)



- After check-out, Remote Extension Dial Lock is activated, and outside calls from the room extension are restricted. (Refer to "2.1.1 Extension Control".)
- After check-out, wake-up call and Call Log information for the room extension are cleared automatically. In addition, features set on the room extension are reset to the default settings. For a list of features that are reset, refer to "1.9.14 Clearing Features Set at Your Extension (Extension Feature Clear)".
- When the room status of extensions is changed, detailed room status information is recorded automatically. This requires system programming.

<Example>

Date	Time	Ext	CO	Dial Number
02/03/00	08:08AM	1234		Check out

- To print out an invoice, a printer should be connected to the PBX. If the room extension is in use, an invoice cannot be printed out.

<Example>

```

*****
*                               *
*               Hotel           *
*****
Check in  : 01.JAN.00 06:31PM
Check out : 03.JAN.00 07:03AM
Room      : 202 : Mr. Smith

01/01/00 06:52PM 202 01 Call amount:0012 01:24'30 00084.50 001
02/01/00 06:07PM 202 01 123456789          00:10'12 00010.20 1234567890
02/01/00 07:30PM 202 01 012345678901234   00:06'36 00006.60 12345
02/01/00 08:45PM 202 01 0011234567890123 00:03'00 00003.00 12345

Telephone          104.30 (Tax 10.000% = 9.48)
Minibar            4.00 (Tax 10.000% = 0.36)
Others              0.00 (Tax 15.000% = 0.00)
-----
Total              FR 108.30 (Tax Total = 9.84)

Sheet : 002

===== Hotel PBX =====
Tel: +41 3 12 34 56 78 Fax: +41 3 12 34 56 78
E-Mail: 12345678@hotelpbx.ch
    
```

- The PBX can store a limited amount of room information. When this storage becomes almost full, the information of the extension that made the most calls is printed out automatically. In this case, the printout is similar to the example above, but without categorised charge information and the total. The PBX can then store new room information. "Call amount:0012" in the example above indicates that the information of 12 phone calls has previously been printed out automatically.



### Customising Your Phone

- 3.1.3 Customising the Buttons  
Create or edit a Check-in or a Check-out button.

## ◆◆ Setting a Timed Reminder to a Room Extension (Remote Wake-up Call)

The hotel operator can remotely set or cancel a Timed Reminder to a room extension. This allows guests to request wake-up calls without having to program the extension themselves. The hotel operator can also confirm the current Timed Reminder setting for a room extension.

### To set

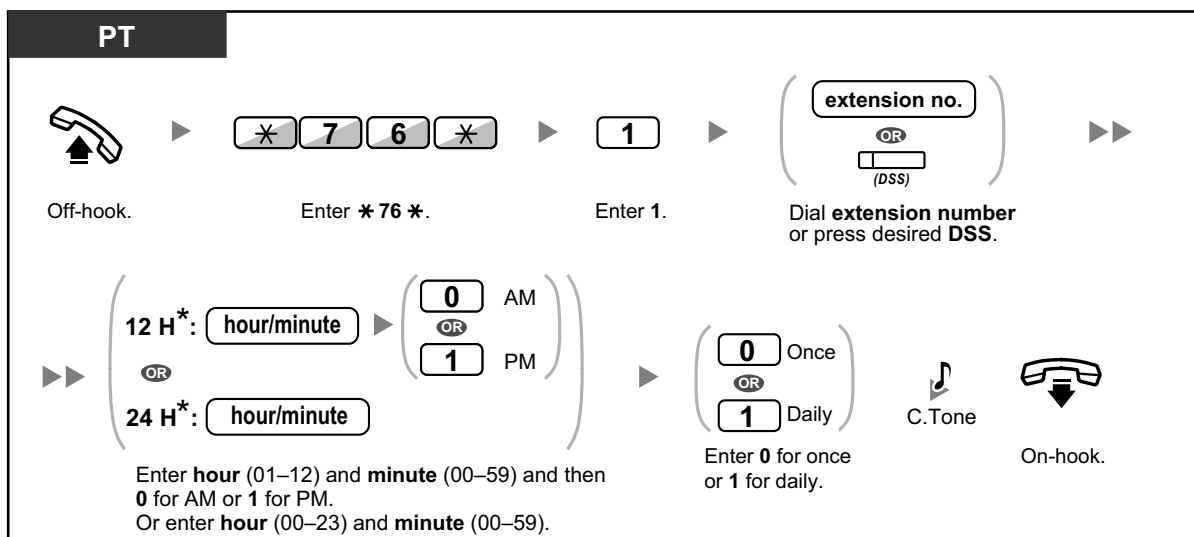

- \* Enter the time in the format assigned to your PBX (12-hour or 24-hour).

### To cancel

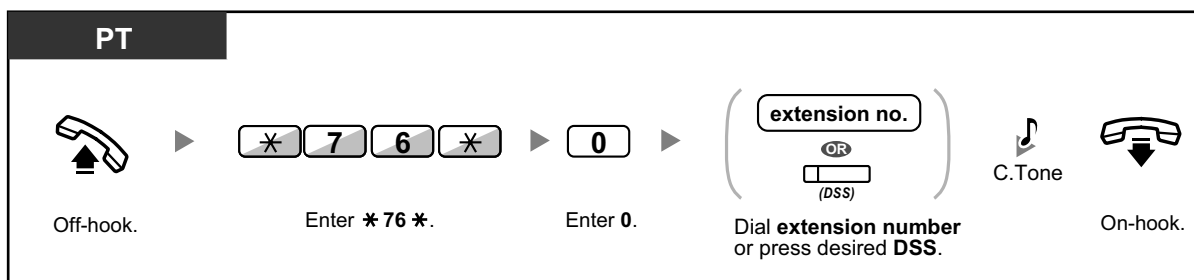

To confirm

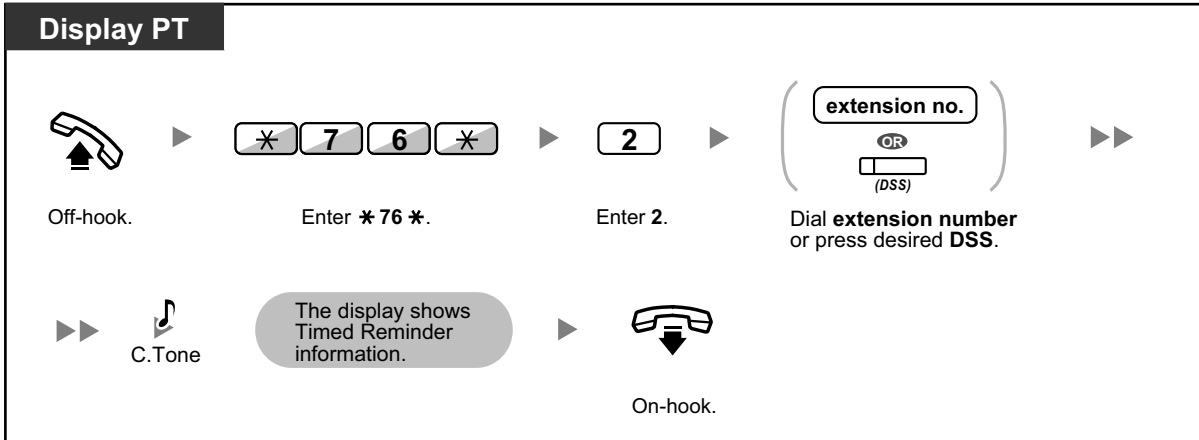

- Timed Reminder can also be set from the room extension. (For information about setting Timed Reminder, refer to "1.9.1 Setting the Alarm (Timed Reminder)".) The most recent setting will be valid no matter which extension made the setting.
- When a Timed Reminder starts, and when it is answered or not answered, detailed Timed Reminder information is recorded automatically. This requires system programming.  
<Example>

Date	Time	Ext	CO	Dial Number
02/02/00	02:45PM	1234		Timed Reminder/Start
02/02/00	02:47PM	1234		Timed Reminder/Answer



- Users of PTs without displays can confirm only whether a Timed Reminder has been set or not by following the steps shown above. If set, a confirmation tone will be heard.

◆◆ Cleaned-up

The hotel operator can change the room status of extensions depending on whether the room has been cleaned or not by using the Cleaned-up button assigned on his/her extension. This allows the hotel operator to confirm that the room is clean and ready for the next guest.

To change the cleaning status of a room

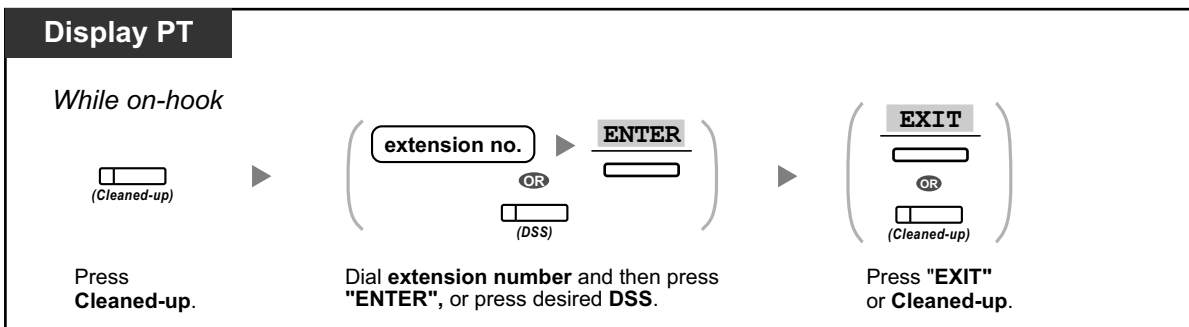



### Customising Your Phone

- 3.1.3 Customising the Buttons  
Create or edit a Cleaned-up button.

## 1.12.2 Recording Information Using Preprogrammed Messages (Printing Message)

You can record a variety of information from your extension using up to 8 preprogrammed messages. Message information from all extensions is recorded with the PBX. For example, it is possible to use this feature as a time card by selecting preprogrammed "sign in" and "sign out" messages. In a hotel-type environment, this feature can be used to record room information from a room extension. For a list of preprogrammed messages, consult your dealer.

### To record

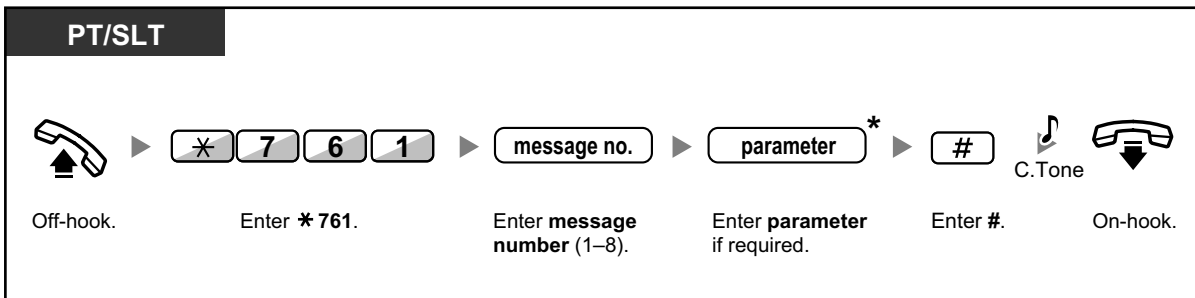

- \* Depending on the content of the selected message, you may be required to enter a numeric parameter, such as a price or time. Enter the correct number of characters as required for the message. For information about required parameters, consult your dealer.  
<Example>  
If "Snack %%.%" has been programmed as message number 1 (for recording charges for room snacks consumed), hotel employees would enter data as in the example below using the room extension:

\* 761                    1                    0300                    #  
                                  |                    |  
                                  message no.    parameter  
  (Snack charge)

- When a preprogrammed message is selected, detailed information is recorded automatically, as shown below:

Date	Time	Ext	CO	Dial Number
02/02/00	10:45AM	1234		Snack 03.00

- Any charges recorded here are not related to charges that the hotel operator records when checking out a room.



## 1.13 Exchanging the Settings between Extensions

### 1.13.1 Walking Extension

You can exchange the settings set at another extension with your own settings. This allows you to use your own settings, including your extension number, on another person's extension. Settings such as extension number and One-touch Dialling memory are available at the new extension. It is also possible to exchange the DSS Console settings along with the extension settings. Walking Extension is useful, for example, when you move to a new location in the office.

This feature is also known as Walking Station.

#### To exchange your settings with another extension

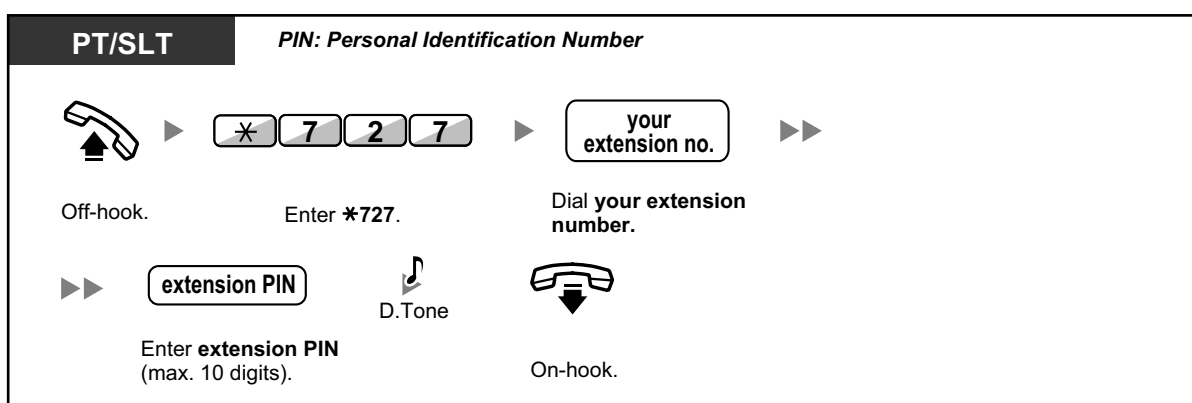

- An extension personal identification number (PIN) is required to use this feature. Refer to "◆◆ Assigning an Extension PIN to Your Extension (Extension PIN [Personal Identification Number])" in "3.1.1 Customising Your Phone (Personal Programming)".
- Your previous extension will receive the old settings of your new extension.
- Extension settings can be exchanged between SLT and SLT, PT and PT, or SLT and PT.
- If you are using a KX-NT300 series (except KX-NT321)/KX-NT560/KX-DT343/KX-DT346 telephone with a Bluetooth wireless headset, and exchange the settings with another KX-NT300 series (except KX-NT321)/KX-NT560/KX-DT343/KX-DT346 telephone user, you cannot use your Bluetooth wireless headset at the other extension. Bluetooth wireless headsets are registered on extensions themselves. Therefore, you have to register a Bluetooth wireless headset on each desired extension. For details about registration, refer to "Bluetooth Registration" in "3.1.2 Settings on the Programming Mode".

## 1.13.2 Enhanced Walking Extension

In addition to exchanging the settings between extensions (Walking Extension), you can change the status of your extension to "Service-in" or "Service-out" (Enhanced Walking Extension).

**Service-in:** An extension is in use (normal status).

**Service-out:** Extension Dial Lock (→ 1.6.3 Preventing Other People from Using Your Telephone (Extension Dial Lock)), Do Not Disturb (DND) (→ 1.9.2 Refusing Incoming Calls (Do Not Disturb [DND])) and Display Lock (→ 3.1.2 Settings on the Programming Mode) are activated on an extension. When the extension is set to "Service-out", the extension user cannot do the following:

- Make unauthorised outside calls
- Receive calls
- See their personal speed dialling directory, call log, or SVM log

This feature is useful when:

- one person uses the same extension settings at different locations, such as another branch office or at home
- two or more people use the same telephone in turn

### <Example (a)> When using extension settings at a different location

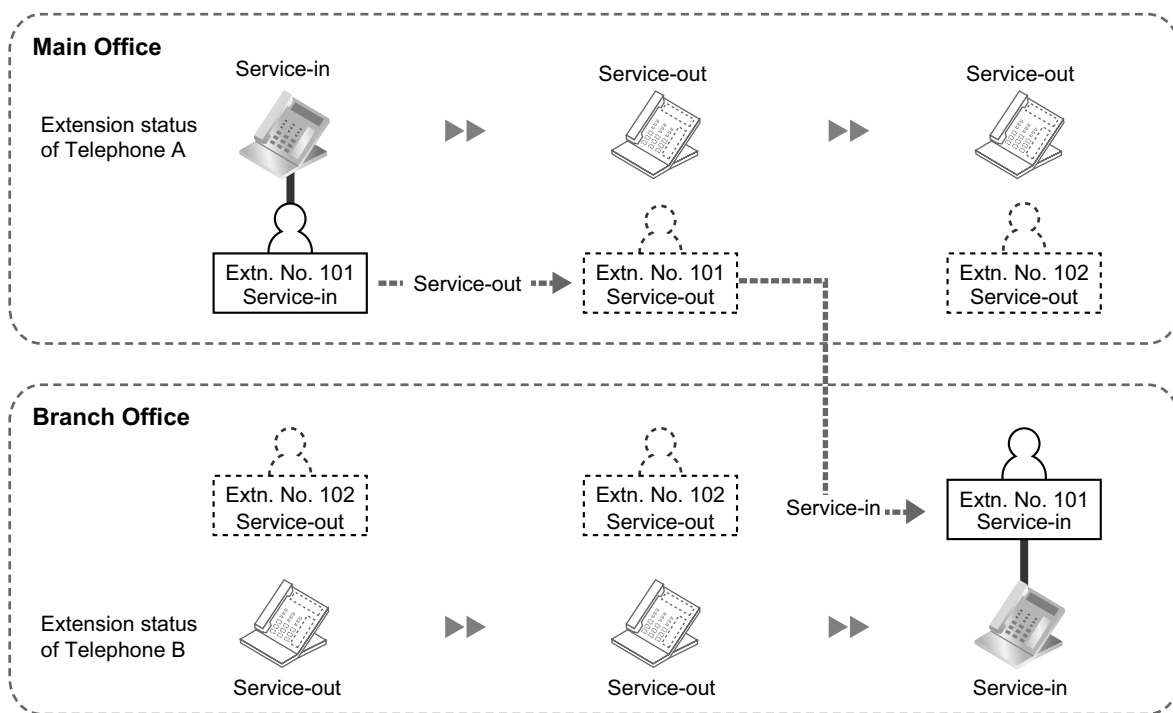

In this example, extension user A sets his/her own extension status to "Service-out" at the main office. Then, he/she can set another extension status to "Service-in" at the branch office to have his/her own extension settings available at the extension.

<Example (b)> When two users share one telephone

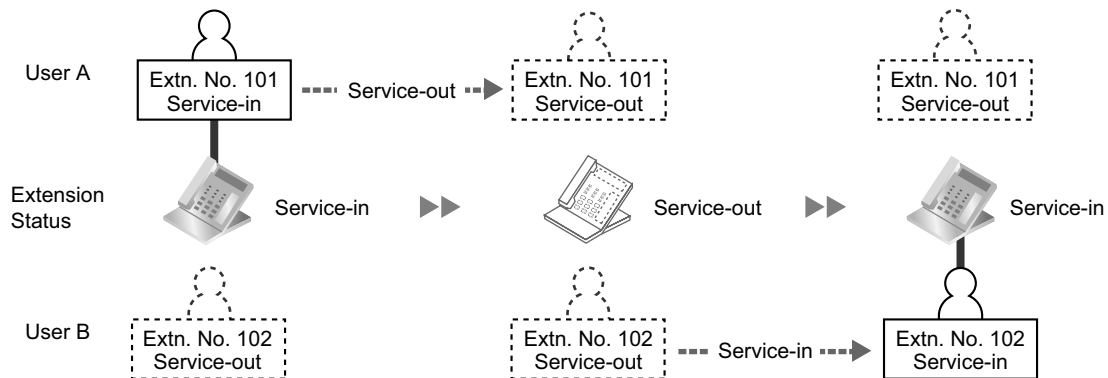

In this example, extension users A and B work in shifts and use the same extension in turn. User A sets the extension status to "Service-out" when he/she finishes work. Then, user B can set the extension status to "Service-in" and have his/her own settings available at the extension.

To set an extension to Service-out status

**PT/SLT**

Off-hook.      Enter \*727.      Enter #.      On-hook.

To set an extension to Service-in status and have your own settings available

**PT/SLT**      *PIN: Personal Identification Number*

Off-hook.      Enter \*727.      Enter \*.      C.Tone      Dial your extension number.

extension PIN      C.Tone      On-hook.

Enter extension PIN (max. 10 digits).



- An extension personal identification number (PIN) is required to use this feature. Refer to "◆◆ Assigning an Extension PIN to Your Extension (Extension PIN [Personal Identification Number])" in "3.1.1 Customising Your Phone (Personal Programming)".
- Extension settings can be exchanged between SLT and SLT, PT and PT, or SLT and PT.

# 1.14 Using a Telephone with a Display

## 1.14.1 Using the Call Log

This is available for display proprietary telephones, portable stations, KX-UT series SIP phones, and S-PSs.

- ◆◆ Calling with the Incoming Call Log
- ◆◆ Calling with the Outgoing Call Log



- PS and S-PS users: Refer to the documentation for your phone.
- KX-UT series SIP phone users: Both outside call information and intercom call information is recorded automatically in the incoming call log. For details about using the call log, refer to the documentation for your KX-UT series SIP phone.
- The following PSs can use incoming call log information from other extensions (including TIE) with same information as a PT connected to the PBX.  
KX-TCA185/KX-TCA285/KX-TCA385
- PSs other than these may not display the same incoming call log information as a PT connected to the PBX.
- For details about referencing the incoming call log, refer to the PS's documentation.

### ◆◆ Calling with the Incoming Call Log

When you receive a call, including external sensor calls, call information is recorded automatically in the incoming call log. A preprogrammed number of calls can be logged per extension.

When the call log is full and other call arrives, the oldest call is deleted.

You can modify the logged telephone number.

When the Call Log button light turns on, there is a call which you did not answer.

The following information is logged.

- Caller's Name
- Date/Time call received
- Answered or Not Answered  
Confirmed or Not Confirmed
- Caller's Phone Number

#### To confirm the log information with the Call Log button

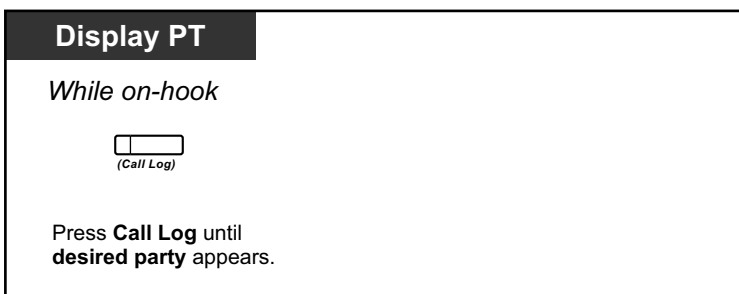

### To confirm the log information with the Navigator Key

**KX-NT300/KX-NT500/KX-DT300/KX-DT500/KX-T7600**

*While on-hook*



Press **Left** twice.      Press **Up** or **Down** until **desired party** appears.

### To clear the log information

**Display PT**

*While confirming the log information*



Press **Call Log**, or **Up** or **Down** until **desired party** appears.      Press **TRANSFER**.

### To call

**Display PT**

*While confirming the log information*



Press **Call Log**, or **Up** or **Down** until **desired party** appears.      Off-hook.

### To store the caller's information in personal speed dialling

**Display PT**

*While confirming the log information*



Press **Call Log**, or **Up** or **Down** until **desired party** appears.      Press **STORE**.

### 1.14.1 Using the Call Log



- The Call Log button light shows the current status as follows:  
**Off:** No incoming call. Or you have already viewed the call log.  
**Red on:** You have missed calls to view.
- If your call is answered by another extension, the caller's information is recorded on the displays of both your extension and the answering extension.
- You can lock your call log display by using an extension PIN (Personal Identification Number), so that you can prohibit access to your logged information (Display Lock). Refer to "3.1.2 Settings on the Programming Mode".
- You can also have a Call Log button for an ICD Group (Incoming Call Distribution Group).
- If a call arrives while you are using the call log, the call log display will be replaced with the caller's information.



#### Customising Your Phone

- 3.1.3 Customising the Buttons  
Create or edit a Call Log button or Call Log for ICD Group button.

## ◆◆ Calling with the Outgoing Call Log

You can redial using the outgoing call log.

#### To call

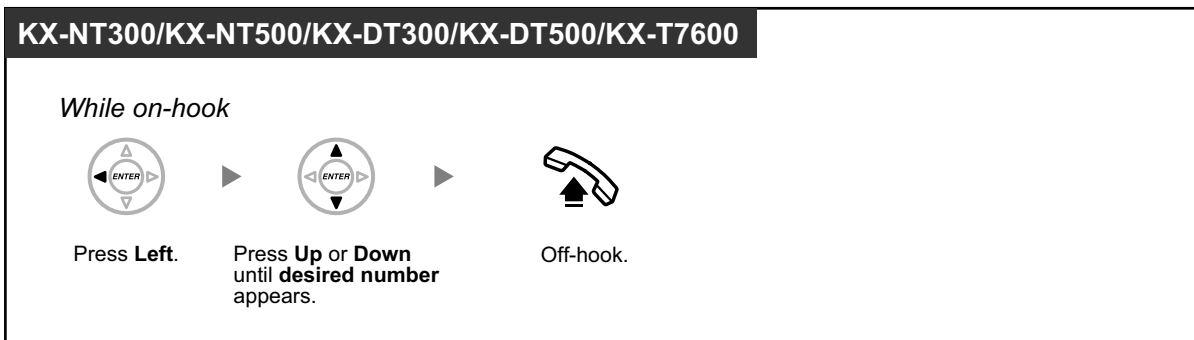

- The following PSs can use outgoing call log information to other extensions (including TIE) with same information as a PT connected to the PBX.  
KX-TCA185/KX-TCA285/KX-TCA385
- PSs other than these may not display the same outgoing call log information as a PT connected to the PBX.
- For details about referencing the outgoing call log, refer to the PS's documentation.

#### To call with the REDIAL button

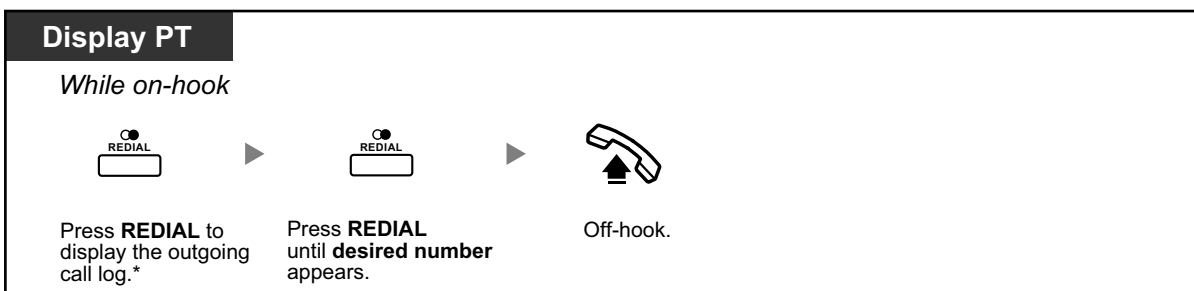



- \* System programming is required for this operation.
- This operation is available only for PTs with a display.

### To store the caller's information in personal speed dialling

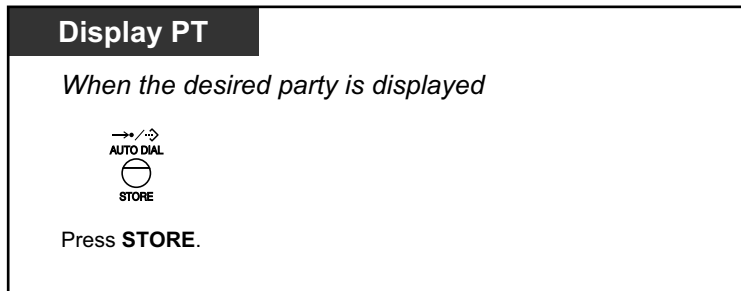

- You can lock your call log display by using an extension PIN (Personal Identification Number), so that you can prohibit access to your logged information (Display Lock). Refer to "3.1.2 Settings on the Programming Mode".
- If a call arrives while you are using the call log, the call log display will be replaced with the caller's information.

## 1.14.2 Using the Directories

You can call using the directories (*Personal Speed Dialling Directory, System Speed Dialling Directory and Extension Number Directory*).

Only personal directories can be stored, edited or deleted on your extension.

If a call arrives while you are using a directory, the display will be replaced with the caller's information.

- ◆◆ Calling with the Directory
- ◆◆ Storing Names and Numbers
- ◆◆ Entering Characters



- PS users: Refer to the documentation for your PS.

### ◆◆ Calling with the Directory

To select and call



- \* The display order is as follows:
  - One time: Personal Speed Dialling Directory
  - Two times: System Speed Dialling Directory
  - Three times: Extension Number Directory
- To cancel or exit, press the CANCEL or FLASH/RECALL button.
- You can lock your personal speed dialling directory by using an extension PIN (Personal Identification Number), so that you can prohibit access to it (Display Lock). Refer to "3.1.2 Settings on the Programming Mode".



- Directory entries generally should include name and number. If the name is not registered, an entry cannot be displayed.
- The System Speed Dialling Directory can be displayed simply by pressing the AUTO DIAL/STORE button while on-hook.



## ◆◆ Storing Names and Numbers

To store a Personal Speed Dialling Directory item

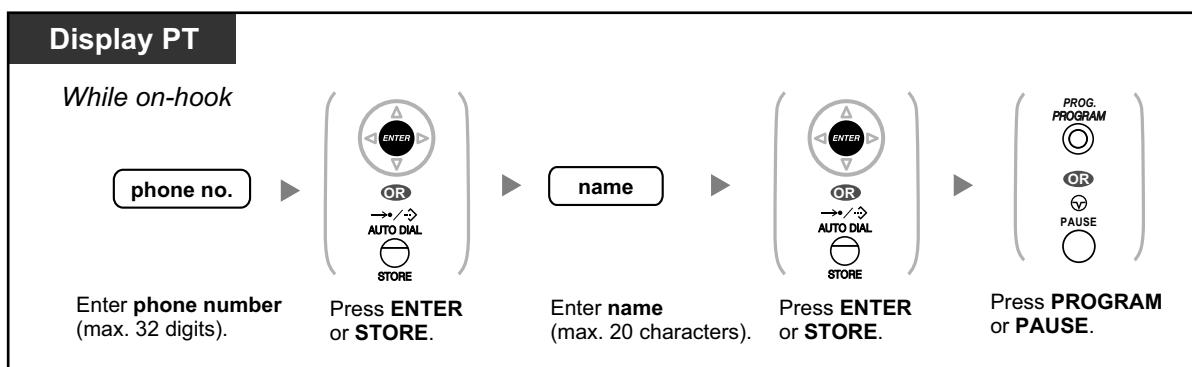

- Telephone numbers and names displayed are stored using the first spare Personal Speed Dialling memory available.



- For more details, refer to "To store the names and numbers in personal speed dialling" in "3.1.2 Settings on the Programming Mode".

## ◆◆ Entering Characters

You can enter the following characters. The tables show you the characters available for each button. Table 1 or Table 2 can be programmed.

### Note

For NE models, the tables for Option mode differ depending on the the system settings. For details, consult your dealer.

**Table 1 (Standard mode)**

Times Buttons	1	2	3	4	5	6	7	8	9
1	!	?	"	1					
2	A	B	C	a	b	c	2		
3	D	E	F	d	e	f	3		
4	G	H	I	g	h	i	4		
5	J	K	L	j	k	l	5		
6	M	N	O	m	n	o	6		
7	P	Q	R	S	p	q	r	s	7
8	T	U	V	t	u	v	8		
9	W	X	Y	Z	w	x	y	z	9
0	(Space)	.	,	'	:	;	0		
*	/	+	-	=	<	>	*		
#	\$	%	&	@	(	)	€	£	#

Table 1 (Standard mode for RU/UC model)

Times Buttons	1	2	3	4	5	6	7	8	9
1	!	?	"	1					
2	A	B	C	a	b	c	2		
3	D	E	F	d	e	f	3		
4	G	H	I	g	h	i	4		
5	J	K	L	j	k	l	5		
6	M	N	O	m	n	o	6		
7	P	Q	R	S	p	q	r	s	7
8	T	U	V	t	u	v	8		
9	W	X	Y	Z	w	x	y	z	9
0	(Space)	.	,	'	:	;	0		
*	/	+	-	=	<	>	*		
#	\$	%	&	@	(	)	■	■	#

**Table 2 (Option mode)**

Times Buttons	1	2	3	4	5	6	7	8	9	10	11	12	13	14	15
1	!	?	"	ä	ö	ü	1								
2	A	B	C	a	b	c	À	Á	Â	Ã	Ä	Å	Æ	Ç	2
3	D	E	F	d	e	f	Ð	È	É	Ê	Ë	3			
4	G	H	I	g	h	i	Ì	Í	Î	Ï	4				
5	J	K	L	j	k	l	5								
6	M	N	O	m	n	o	Ñ	Ò	Ó	Ô	Õ	Ö	Ø	Œ	6
7	P	Q	R	S	p	q	r	s	Š	ß	7				
8	T	U	V	t	u	v	Û	Ú	Û	Ü	8				
9	W	X	Y	Z	w	x	y	z	Ý	Ž	9				
0	(Space)	.	,	'	:	;	0								
*	/	+	-	=	<	>	*								
#	\$	%	&	@	(	)	€	£	#						

Table 2 (Option mode for NE model)

Times Buttons	1	2	3	4	5	6	7	8	9	10	11	12	13	14	15
1	!	?	"	ä	ö	ü	1								
2	A	B	C	a	b	c	Á	Â	Ă	Ä	Å	Ć	Ç	Č	2
3	D	E	F	d	e	f	Ď	Đ	É	Ę	Ě	ě	3		
4	G	H	I	g	h	i	Í	Î	4						
5	J	K	L	j	k	l	Ĺ	Í	5						
6	M	N	O	m	n	o	Ń	Ň	Ó	Ô	Õ	Ö	6		
7	P	Q	R	S	p	q	r	s	Ř	Ř	Š	Ś	Ş	ß	7
8	T	U	V	t	u	v	Ť	Ṭ	ű	Ú	Ů	Ü	8		
9	W	X	Y	Z	w	x	y	z	Ž	Ž	Ž	Ý	9		
0	(Space)	.	,	'	:	;	0								
*	/	+	-	=	<	>	*								
#	§	%	&	@	(	)	€	£	#						

**Table 2 (Option mode for Greece)**

Times Buttons	1	2	3	4	5	6	7	8	9
1	!	?	"	1					
2	A	B	Γ	2					
3	Δ	E	Z	3					
4	H	Θ	I	4					
5	K	Λ	M	5					
6	N	Ξ	O	6					
7	Π	P	Σ	7					
8	T	Υ	Φ	8					
9	X	Ψ	Ω	9					
0	(Space)	.	,	'	:	;	0		
*	/	+	-	=	<	>	*		
#	\$	%	&	@	(	)	€	£	#

Table 2 (Option mode for RU/UC model)

Times Buttons	1	2	3	4	5	6	7	8	9	10	11
1	А	Б	В	!	?	"	1				
2	Г	Д	Е	Ё	2						
3	Ж	З	И	Й	3						
4	К	Л	М	4							
5	Н	О	П	5							
6	Р	С	Т	6							
7	У	Ф	Х	7							
8	Ц	Ч	Ш	8							
9	Щ	Ъ	Ы	Ь	9						
0	Э	Ю	Я	(Space)	.	,	'	:	;	0	
*	/	+	-	=	<	>	Г	€	І	İ	*
#	\$	%	&	@	(	)	€	І	Ÿ	#	

## 1.14.3 Accessing System Features (System Feature Access)

You can access a feature with the "Feature Access" menu.

To access "Feature Access" menu and select the feature

**KX-NT300/KX-NT500 (except KX-NT511)/KX-DT300/KX-DT500/KX-T7600**

*While on-hook*



Press **Right** four times. Press **Up** or **Down** until **the feature** appears.

Features	Refer to
Automatic Callback Busy Cancel	1.2.4 When the Dialed Line is Busy or There is No Answer
Group Call Pickup	1.3.3 Answering a Call Ringing at Another Telephone (Call Pickup)
Directed Call Pickup	1.3.3 Answering a Call Ringing at Another Telephone (Call Pickup)
Paging	1.7.1 Paging
Doorphone Call	1.11.1 If a Doorphone/Door Opener is Connected
Door Open	1.11.1 If a Doorphone/Door Opener is Connected
External Relay	1.11.2 If an External Relay is Connected
External Background Music	2.1.4 Turning on the External Background Music (BGM)

**KX-UT series**

*While on-hook*



Press "Menu". Press **Up** or **Down** until **the feature** appears.\*

Features	Refer to
Group Paging	1.7.1 Paging
Directed Call Pickup	1.3.3 Answering a Call Ringing at Another Telephone (Call Pickup)



Features	Refer to
Directed Group Call Pickup	1.3.3 Answering a Call Ringing at Another Telephone (Call Pickup)
Data Line Security	1.9.9 Protecting Your Line against Notification Tones (Data Line Security)



- **\*For KX-UT670 users:**  
Tap "Feature access code" instead of pressing Up or Down.

## 1.14.4 Self Labelling (KX-NT366/KX-NT553/KX-NT556/KX-NT560/KX-UT248/KX-UT670 only)

The KX-NT366/KX-NT553/KX-NT556/KX-NT560 IP-PT and KX-UT248/KX-UT670 SIP phone have flexible buttons with an LCD screen next to the buttons.

### For KX-NT366:

The KX-NT366 IP-PT has 12 flexible buttons, and the telephone’s display shows which feature, telephone number, or extension number is assigned to each button. You can press the NEXT PAGE key to display 3 other sets (pages) of 12 flexible button assignments. A different feature, telephone number, or extension number can be assigned to each button in each set. This means that 48 flexible buttons are available.

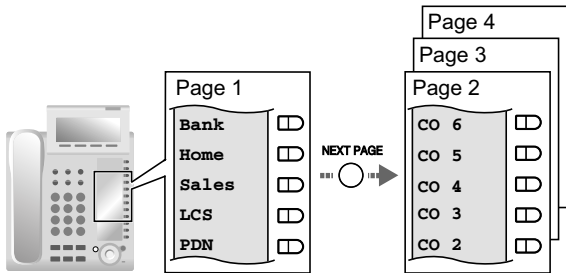

### For KX-NT553/KX-NT556:

The KX-NT553/KX-NT556 IP-PT has 12 flexible buttons, and the telephone’s display shows which feature, telephone number, or extension number is assigned to each button. You can press the NEXT PAGE key to display other sets (pages) of 12 flexible button assignments as below.

	Pages	Total Flexible button
KX-NT553	2	24
KX-NT556	3	36

### Example: KX-NT556

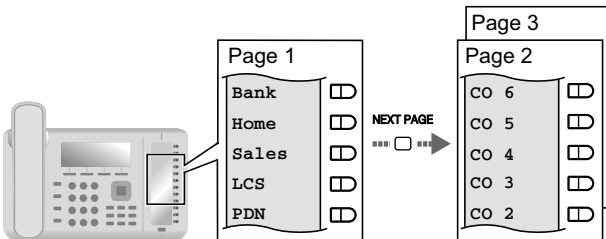

### For KX-NT560:

The KX-NT560 IP-PT has 8 flexible buttons, and the telephone’s display shows which feature, telephone number, or extension number is assigned to each button. You can press the Page key to display 3 other sets

(pages) of 8 flexible button assignments. A different feature, telephone number, or extension number can be assigned to each button in each set. This means that 32 flexible buttons are available.

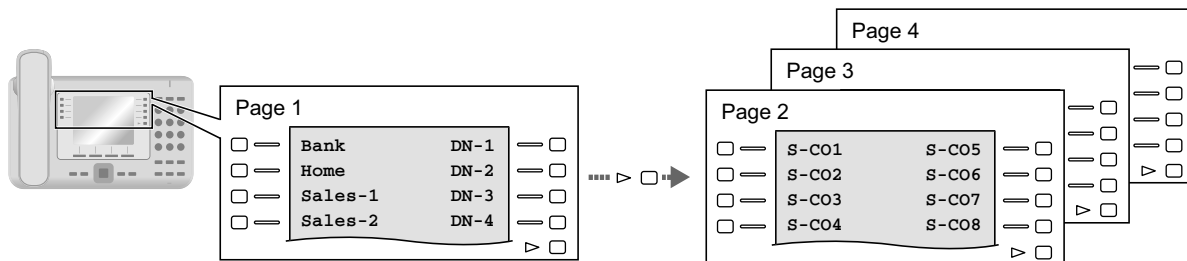

**For KX-UT248:**

The KX-UT248 SIP phone has 8 flexible buttons, and the telephone’s display shows which feature, telephone number, or extension number is assigned to each button. You can press the Page keys to display 2 other sets (pages) of 8 flexible button assignments. A different feature, telephone number, or extension number can be assigned to each button in each set. This means that 24 flexible buttons are available.

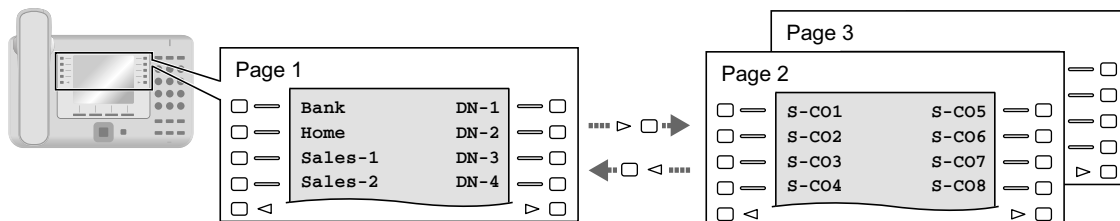

**For KX-UT670:**

The KX-UT670 SIP phone has 24 flexible buttons. Each button can be assigned a feature, telephone number, etc., with a custom label for each. You can switch the display between single-row display and full-screen display. In single-row display, 6 flexible buttons are displayed, and you can press the Page key to display another row of buttons. In full-screen display, all 24 flexible buttons are displayed at once.

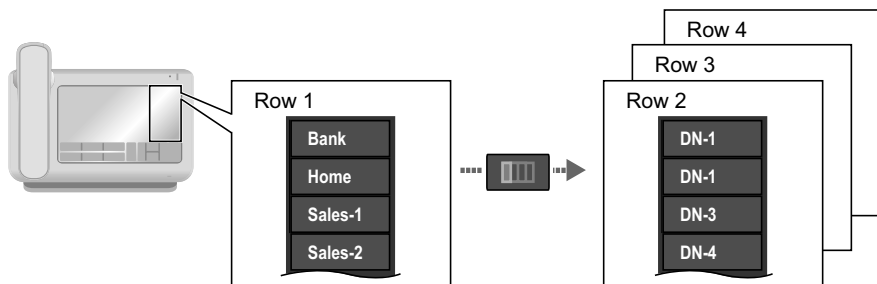

**To switch display**

**KX-NT366/KX-NT553/KX-NT556/KX-NT560/  
KX-UT248/KX-UT670**

NEXT PAGE      OR      ◁      ▷      OR           OR      □      NEXT PAGE

Press **NEXT PAGE** or **Page key** to display the desired page.



- **For KX-NT366/KX-NT553/KX-NT556/KX-NT560 users:**
  - When you answer an incoming call or when you seize an outside line, the display automatically changes to the page that contains the green lit button.
  - After customising each button, you can set the displayed text for the button. For details about customising buttons, refer to "3.1.3 Customising the Buttons".
- **For KX-UT248 and KX-UT670 users:**
  - You can customise the flexible buttons and set the displayed text for each button using Web Maintenance Console. For details about customising buttons, refer to "Customising the Flexible Buttons" in "◆◆ Editing Settings in Web Maintenance Console" in "3.2.1 User Programming".
  - For the KX-UT248, the display shows a maximum of 10 characters for each button. For the KX-UT670, you can specify up to 12 characters, but some characters may not be displayed depending on the characters used.

## 1.15 Cellular Phone Features

### 1.15.1 Cellular Phone Features

When you are not at your desk or not in the office and receive a forwarded outside call on your cellular phone, you can use the following features if enabled through system programming.

- ◆◆ Transferring to an Extension in the PBX
- ◆◆ Transferring to a Private Network (TIE Line Access)
- ◆◆ Transferring to an Outside Phone Number
- ◆◆ Adding Other Parties during a Conversation (Conference)
- ◆◆ Talking to Two Parties Alternately (Call Splitting)
- ◆◆ Paging and then Transferring a Call



- Some features may not be available for cellular phones, depending on the type of outside line being used.

#### ◆◆ Transferring to an Extension in the PBX

To transfer

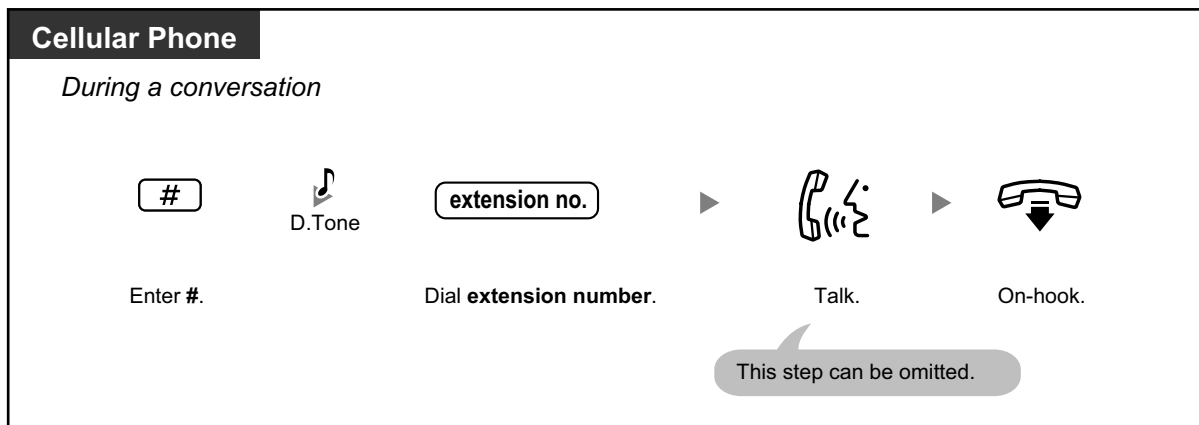

- When transferring a call from an analogue trunk, you cannot talk to the destination party after dialling an extension number.
- You cannot transfer a call to a DISA floating extension number.

#### ◆◆ Transferring to a Private Network (TIE Line Access)

During a conversation, you can make a call to an extension connected to another PBX in a private network and transfer a call to it.

To transfer

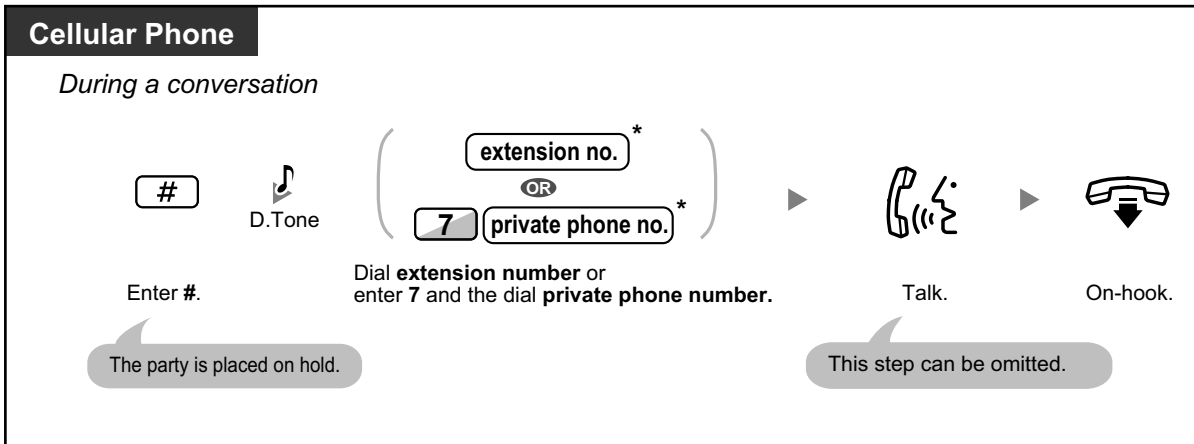

- \* When transferring a call from an analogue trunk, you cannot talk to the destination party after dialling an extension number or 7 + private phone number.

◆◆ Transferring to an Outside Phone Number

During a conversation, you can make a call to an outside phone number and transfer a call to it.

To transfer

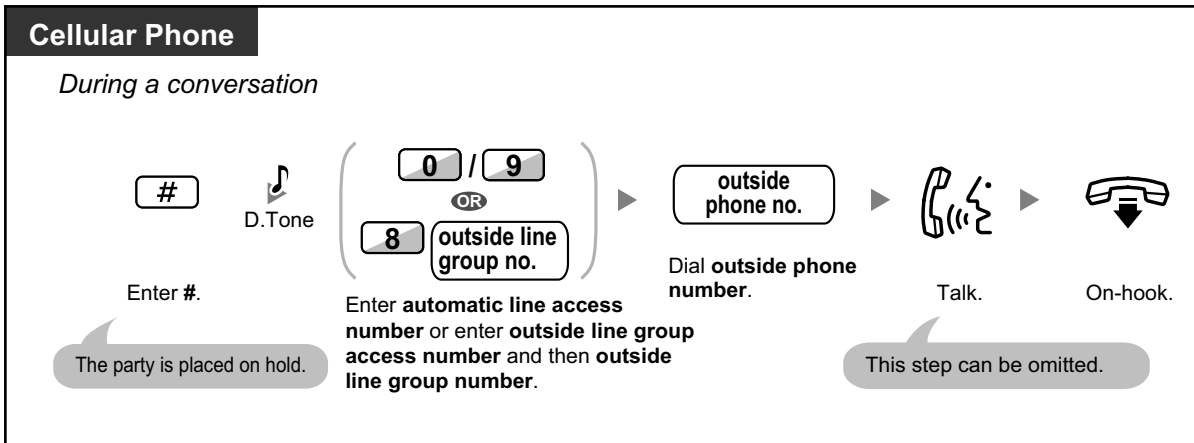

- When transferring a call from an analogue trunk, you cannot talk to the destination party after dialling the outside phone number.

## ◆◆ Adding Other Parties during a Conversation (Conference)

To establish a conference call

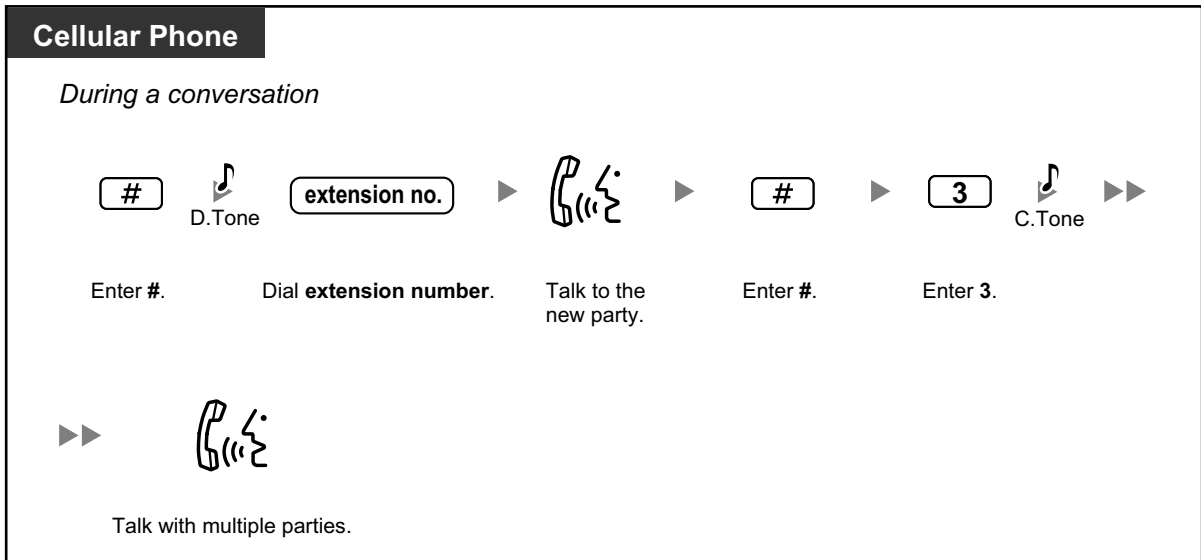

## ◆◆ Talking to Two Parties Alternately (Call Splitting)

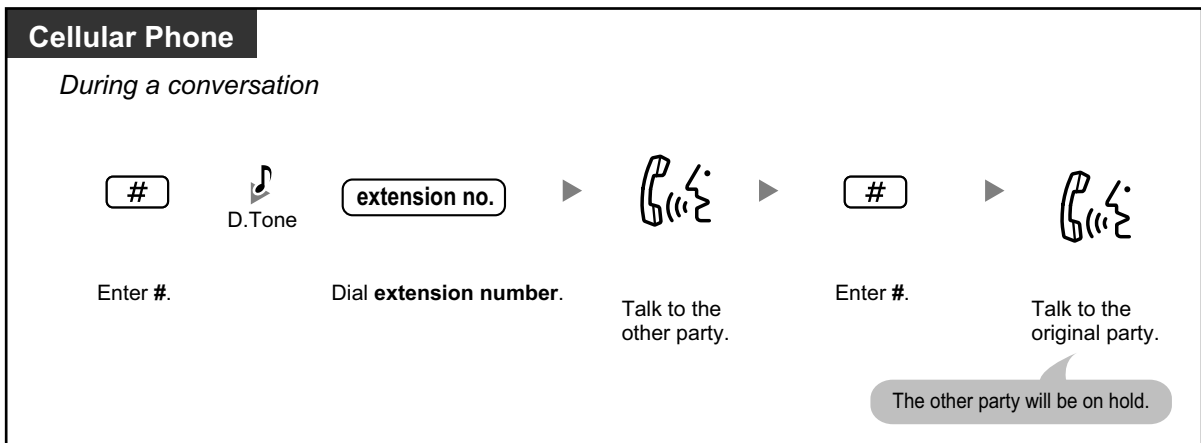

## ◆◆ Paging and then Transferring a Call

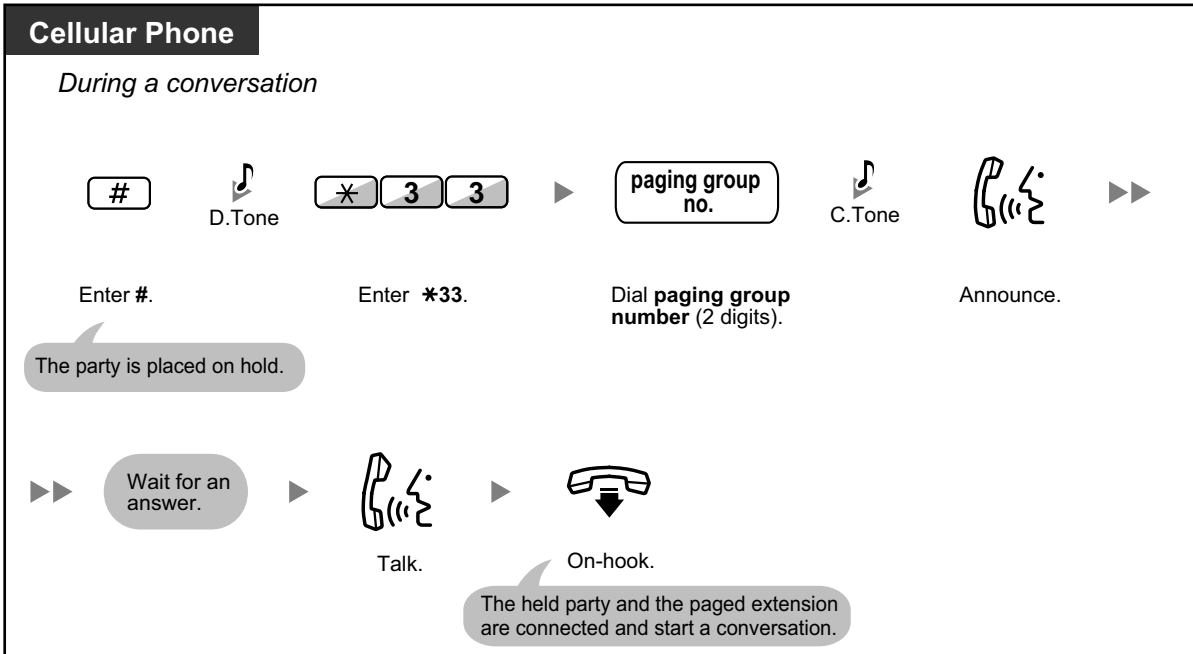



---

## **Section 2**

# ***Manager Operation***

*This section shows the manager how to control the other extensions or the PBX.*

## 2.1 Control Features

### 2.1.1 Extension Control

The manager extension can control the settings of other extensions.

- ◆◆ Changing the Settings of Other Extensions

#### ◆◆ Changing the Settings of Other Extensions

##### To lock/unlock other extensions (Remote Extension Dial Lock)

This feature is also known as Remote Station Lock Control.

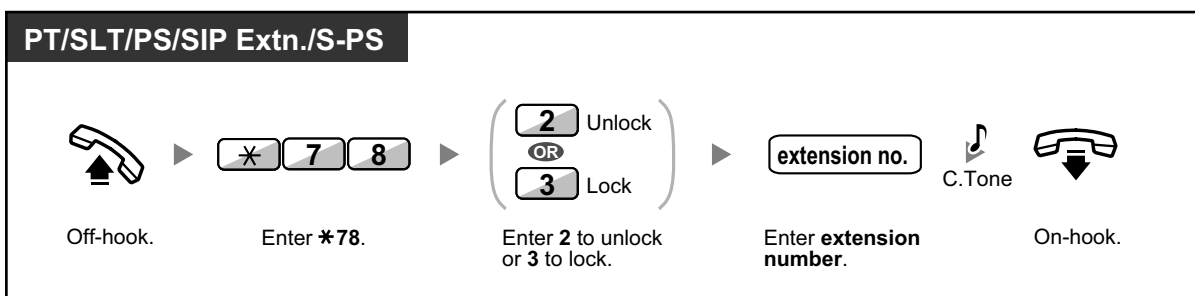

- The manager can use Remote Extension Dial Lock to unlock any extension, whether that extension was locked remotely (Remote Extension Dial Lock) or from the extension itself (Extension Dial Lock).

## 2.1.2 Time Service Mode Control

The manager extension or the preprogrammed extension can change the time mode (Day, Lunch, Break or Night).

There are two methods (Automatic or Manual) of changing the time modes.

**Automatic:** enables the time mode for each day of the week to change automatically. You may also change it manually.

**Manual:** enables to change a mode manually as follows.

### To change the time mode (Day/Night/Lunch/Break)

PT/PS

*While on-hook*

(Time Service  
Day/Night/  
Lunch/Break)

Press **Time Service (Day/Night/Lunch/Break)** until the desired mode appears.

PT/SLT/PS/SIP Extn./S-PS



Off-hook.

\*

7

8

0

Enter \*780.

0

 Day  

1

 Night  

2

 Lunch  

3

 Break

Enter 0 to 3 as you desire.

C.Tone



On-hook.

### To select the time service switching mode (Automatic/Manual)

PT/PS

*While on-hook*

(Time Service  
Switching Mode  
Automatic/Manual)

Press **Time Service Switching Mode (Automatic/Manual)**.

- Besides the time mode, there is Holiday mode. It can change mode once on a specified date.
- The Time Service (Day/Night/Lunch/Break) button light shows the current status as follows:
  - Off:** Day mode
  - Green on:** Lunch mode
  - Flashing green:** Break mode
  - Red on:** Night mode
  - Flashing red:** Holiday mode
- The Time Service Switching Mode (Automatic/Manual) button light shows the current status as follows:
  - Off:** Automatic
  - Red on:** Manual

User Manual | 267



### Customising Your Phone

- 3.1.3 Customising the Buttons  
Create or edit a Time Service (Day/Night/Lunch/Break) button or a Time Service Switching Mode (Automatic/Manual) button.

## 2.1.3 Restriction Level Control (Dial Tone Transfer)

The manager extension can change the restriction level, permitting an extension to make a call.

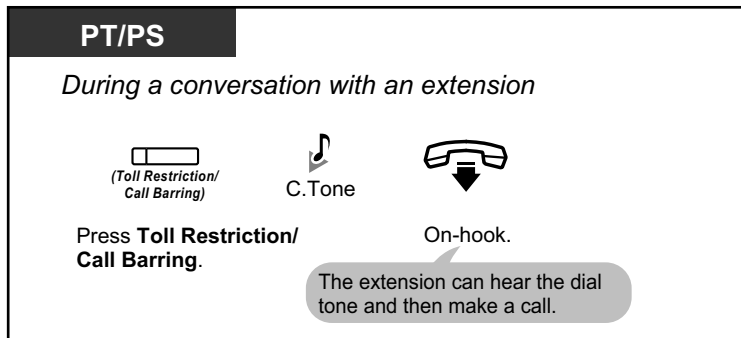

- The restriction level is changed to the preprogrammed level of Toll Restriction/Call Barring button.
- The restriction level of SIP phones and S-PSs cannot be changed.



### Customising Your Phone

- 3.1.3 Customising the Buttons  
Create or edit a Toll Restriction/Call Barring button.

## 2.1.4 Turning on the External Background Music (BGM)

The manager extension can select and broadcast background music in the office through external speakers.

### To select and start/stop the background music

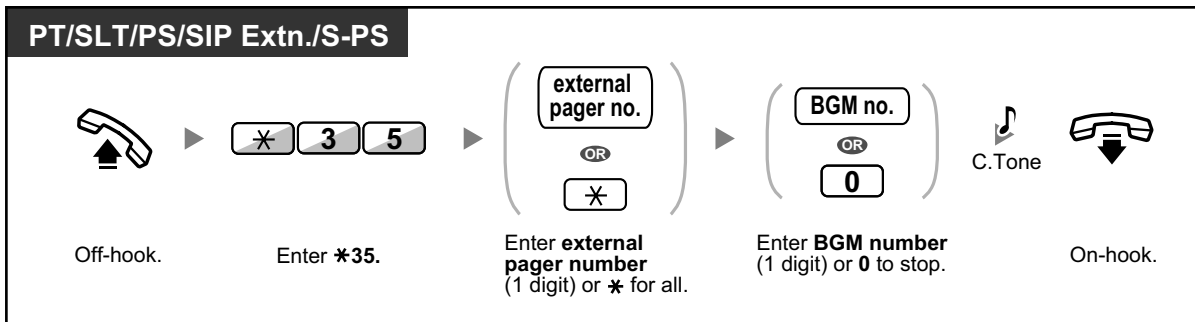

## 2.1.5 Recording Outgoing Messages (OGM)

The manager extension can record three kinds of greeting messages (OGM) as follows:

1. **DISA message:** Used to greet and guide callers so that they access an extension user group or outside party without operator assistance.
2. **Incoming Call Distribution Group message:** Used to greet and guide callers to an incoming call distribution group.
3. **Timed Reminder message:** Used for a wake-up call message when the extension answers the Timed Reminder.



All messages have their own extension numbers. You can select the desired message. You have two methods for recording a message. One is recorded using the handset, and the other is recorded from an external BGM (MOH) port.

### To record

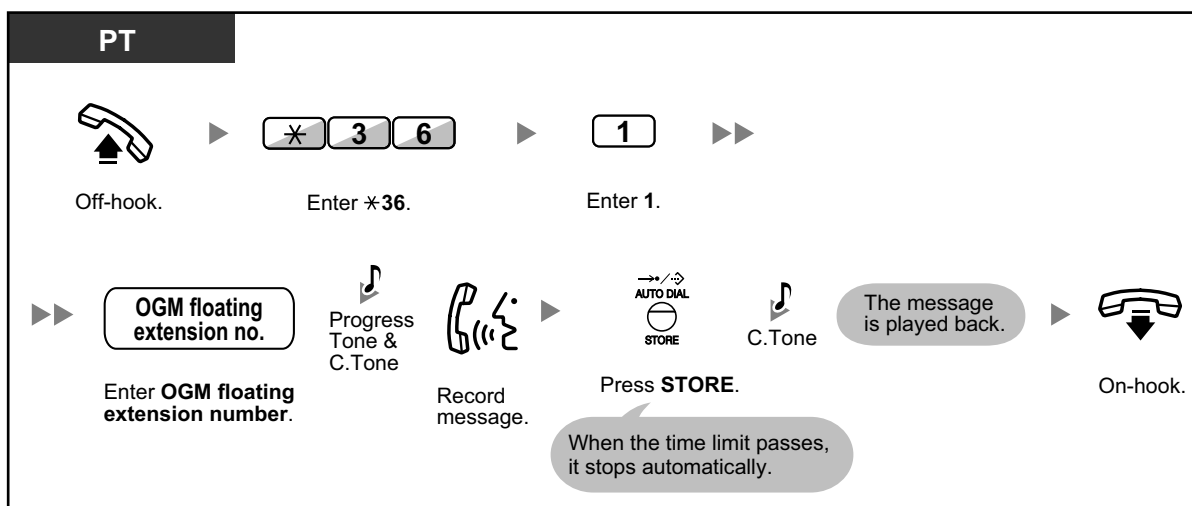

### To play back

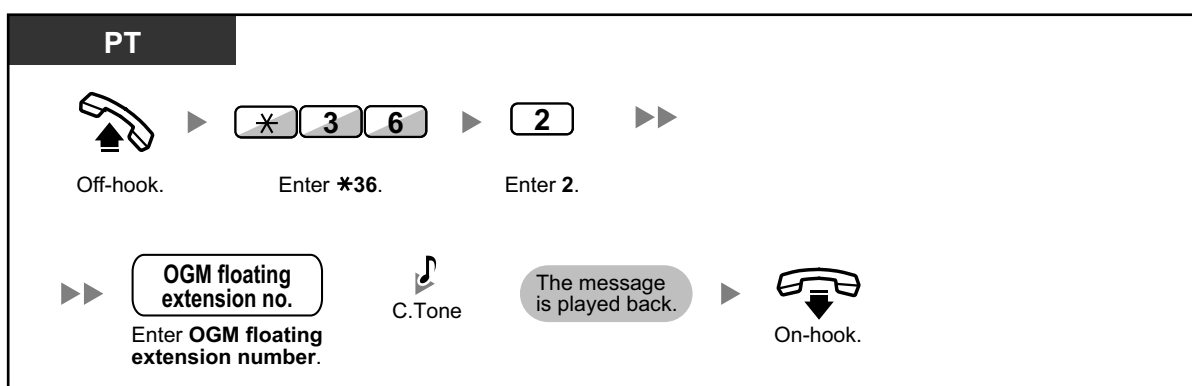

## 2.1.5 Recording Outgoing Messages (OGM)

### To record from an external BGM (MOH) port

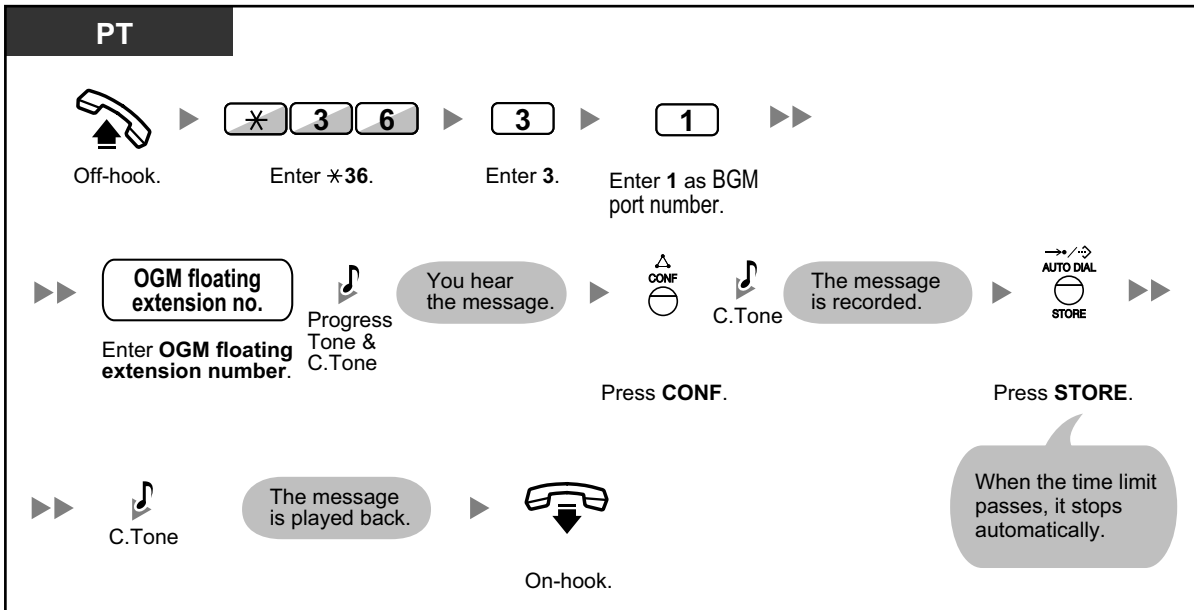

### To clear the message

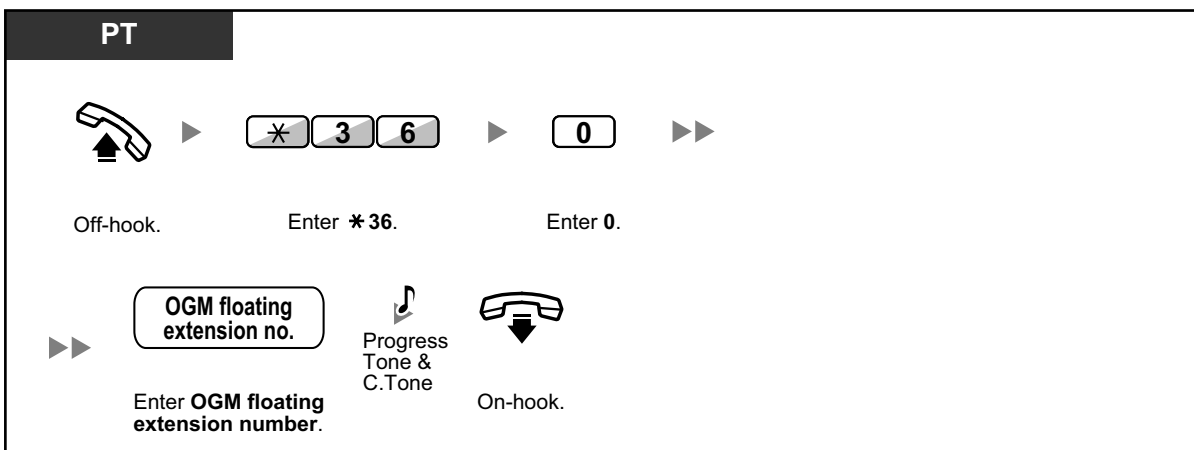

- The default of OGM floating extension numbers depends on system programming. For more information, consult your System Administrator or System Manager.



## 2.1.6 Allowing Users to Seize an Unavailable Outside Line (Trunk Busy Out)

When a problem is found on a certain outside line, the PBX automatically makes it unavailable for use temporarily. The manager can manually enable the outside line and allow users to use it again.

### To re-enable an outside line

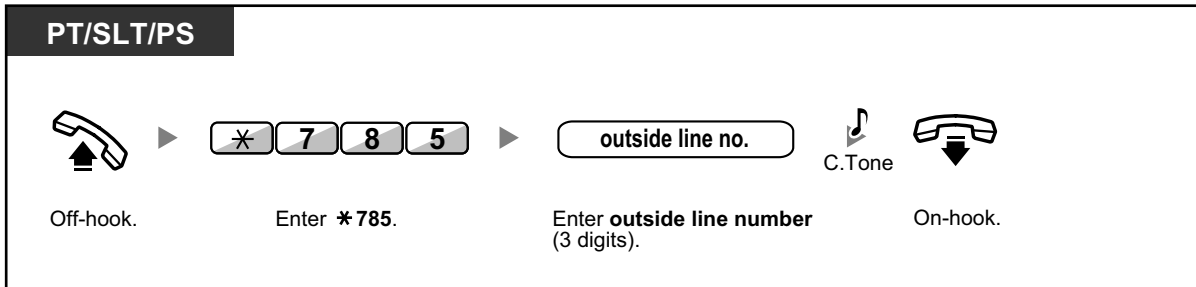

- In some countries/areas, the PBX may not be able to automatically make a faulty outside line unavailable for use.

## 2.1.7 Releasing Network Direct Station Selection (NDSS) Monitor

NDSS buttons can be customised on any extension connected to your PBX. An NDSS button allows an extension user to monitor another extension connected to another PBX in a private network. The NDSS button light shows the current status of the monitored extension in the same way as a DSS button. When it becomes unnecessary to monitor an extension connected to another PBX, the manager can stop the PBX from monitoring it. Any NDSS buttons set to monitor that extension will also stop monitoring.

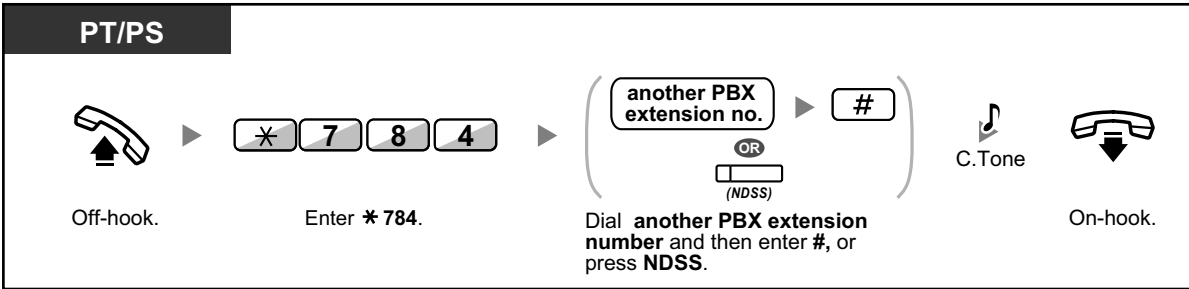

- To restart monitoring of an extension after performing this operation, go off-hook, press the corresponding NDSS button, and go on-hook.



### Customising Your Phone

- 3.1.3 Customising the Buttons  
Create or edit a Network Direct Station Selection (NDSS) button.

## 2.2 Configuring Unified Messaging Features

### 2.2.1 System Manager Features

The System Manager can configure mailboxes, change class of service (COS) settings for subscribers, etc.

- ◆◆ Logging in to the System Manager's Mailbox
- ◆◆ Setting Up Mailboxes
- ◆◆ Setting Class of Service (COS) Parameters
- ◆◆ Remote Time Service Mode Setting
- ◆◆ Changing the Company Greeting and Incoming Call Service Setting
- ◆◆ Broadcasting Messages
- ◆◆ Changing the System Manager's Password

#### ◆◆ Logging in to the System Manager's Mailbox

The procedures described in this section require the System Manager to use a telephone, however, many of these procedures can also be performed using a PC with Web Maintenance Console. For more information, consult your dealer.

In order to perform these procedures with a telephone, the System Manager must log in before performing any System Manager tasks. To log in as the System Manager, 3 items of information must be known: the UM group's floating extension number to access the Unified Messaging system, the System Manager's mailbox number, and the System Manager's mailbox password.

- The System Manager's mailbox number is 999 (default) depending on the mailbox number length specified in system programming.
- The System Manager's password can be assigned by the System Administrator using Web Maintenance Console or by the System Manager using his or her extension telephone (refer to "◆◆ Changing the System Manager's Password").



- Before the System Manager can perform any System Manager tasks, "System Manager Access from Telephone" must be enabled and "Password for System Manager (Up to 16 numeric digits)" must be set by the System Administrator using Web Maintenance Console.
- After logging in, the system will announce the number of total messages, the number of new messages, or the length of new messages. These announcements depend on the mailbox settings and COS settings for the System Manager.
- If there are new messages in the mailbox, the messages will be played automatically. The System Manager can listen to them continuously without listening to the system prompts. This feature is only available when "Autoplay New Message" is activated for the System Manager's COS.
- If the Unified Messaging system is being programmed via Web Maintenance Console, the System Manager cannot create or edit mailboxes. The system will announce, "Sorry, this function is not available".



- For more information on logging in, refer to "Logging in to Your Mailbox for the First Time".
- **Manager Service switching**  
You can switch mailboxes simply by pressing ## from the subscriber service menu, in the following order:

→ Subscriber service → Message Manager service → System Manager service

## 2.2.1 System Manager Features



- **For KX-UT series SIP phone and S-PS users:**  
When using the MESSAGE button, please press the MESSAGE button before going off-hook.

### Manual log-in

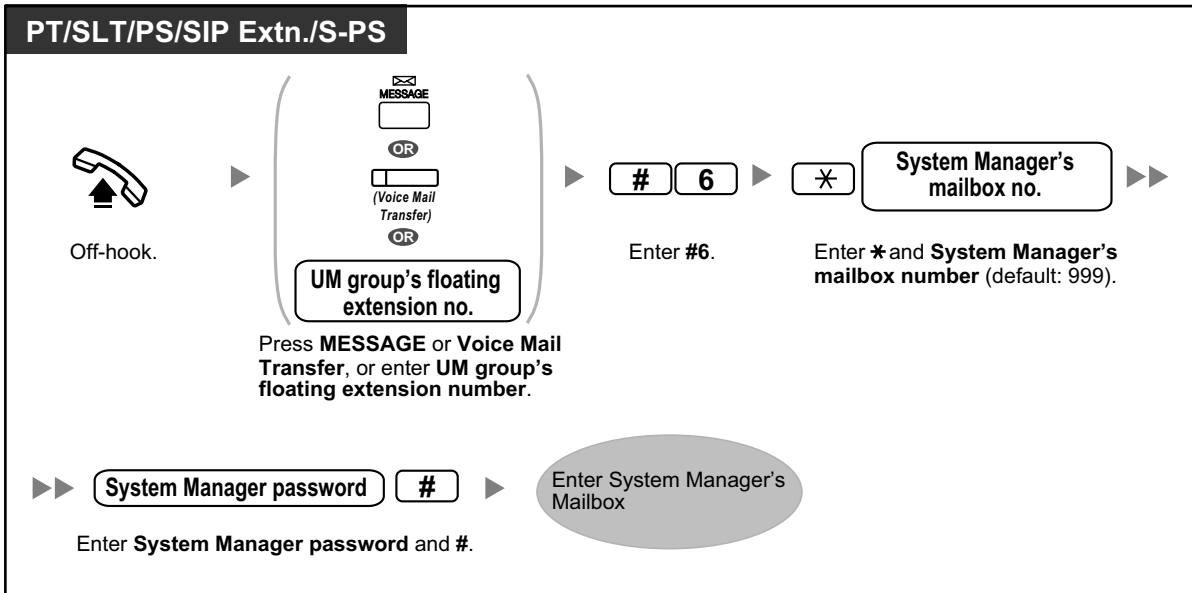

### Remote automatic log-in

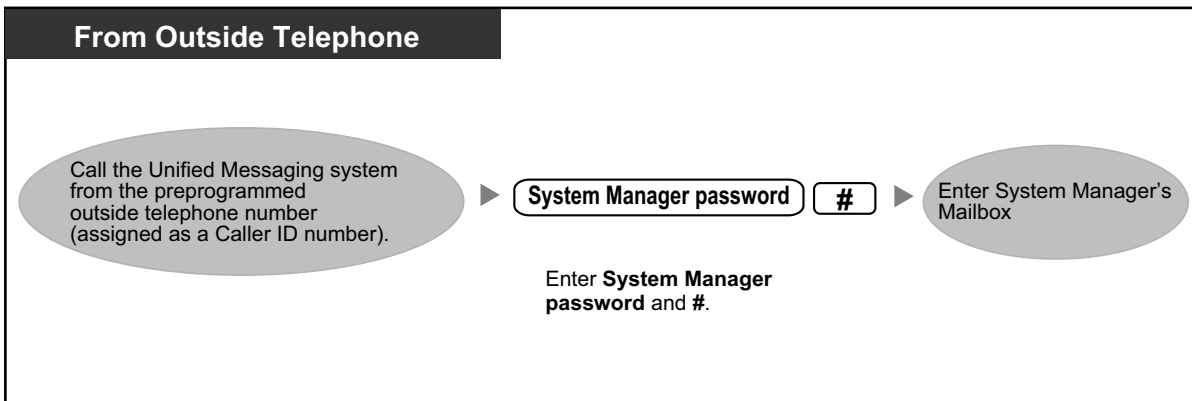

### **CAUTION**

- It is strongly recommended that a password of 16 numbers be used for maximum protection against unauthorised access.
- To avoid unauthorised access to the PBX, keep the password secret. If it becomes known to others, the PBX may be misused.
- Change the password periodically.

### **Notice**

- When disabling the password requirement, ensure that an unauthorised third-party is not allowed access to your extension.

## ◆◆ Setting Up Mailboxes

The System Manager's primary function is to create mailboxes for new subscribers and to maintain system organisation by deleting unneeded passwords and mailboxes.



- If the Unified Messaging system is being programmed via Web Maintenance Console, the System Manager cannot create or edit mailboxes. The system will announce, "Sorry, this function is not available".

### Creating and Editing a Mailbox

The System Manager can create and edit subscriber mailboxes by following the steps below.

When creating a new mailbox, or editing a mailbox's parameters, the following parameters can be set:

- **Mailbox Number**
- **Subscriber's Name:**  
The system allows a maximum of 10 seconds for each name. The name should be spoken slowly and clearly. (We recommend using the subscriber's last name.)
- **Extension Number**
- **First 4 Letters of the Subscriber's Last Name:**  
Enter only the first 4 letters of the owner's last name.
- **First 4 Letters of the Subscriber's First Name:**  
Enter only the first 4 letters of the subscriber's first name.
- **Class of Service Number:**  
Enter any COS number (1–64).
- **Interview Mailbox Number:**  
Interview Mailbox Numbers must not be the same number as an existing mailbox.
- **All Calls Transfer To Mailbox (Change Logical Extension Status):**  
If this parameter is enabled, the extension is considered to be a Logical Extension and therefore calls directed to the extension via Automated Attendant service are automatically forwarded to the extension mailbox. The extension does not ring when a call is received.
- **Message Waiting Lamp Notification:**  
If this parameter is enabled, the Message Waiting Lamp of the subscriber's telephone turns on when a new message is recorded.
- **External Message Delivery:**  
Allows a subscriber to send a message to several subscribers and non-subscribers (including outside parties). If enabled, the prompt mode setting determines the language heard when the system calls the recipient.
- **Auto Forwarding:**  
Moves or copies unplayed messages from one mailbox to another, after a specified period of time.

### To create/edit/delete any mailbox parameter

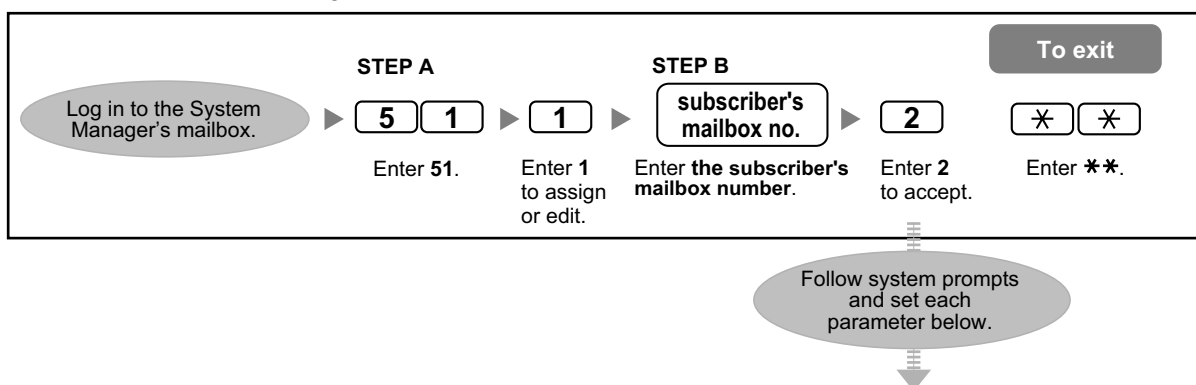

## 2.2.1 System Manager Features

Parameters	Steps
<b>Subscriber's Name</b>	<ol style="list-style-type: none"> <li>1. <input type="text" value="1"/> to change the current setting.</li> <li>2. Record the subscriber's name.</li> <li>3. <input type="text" value="2"/> to accept.</li> </ol>
<b>Extension Number</b>	<ol style="list-style-type: none"> <li>1. <input type="text" value="1"/> to change the current setting.</li> <li>2. Enter the subscriber's extension number.</li> <li>3. <input type="text" value="2"/> to accept.</li> </ol>
<b>First 4 Letters of the Subscriber's Last Name</b>	<ol style="list-style-type: none"> <li>1. <input type="text" value="1"/> to change the current setting.</li> <li>2. Enter the first 4 letters of subscriber's last name.</li> <li>3. <input type="text" value="2"/> to accept.</li> </ol>
<b>First 4 Letters of the Subscriber's First Name</b>	<ol style="list-style-type: none"> <li>1. <input type="text" value="1"/> to change the current setting.</li> <li>2. Enter the first 4 letters of subscriber's first name.</li> <li>3. <input type="text" value="2"/> to accept.</li> </ol>
<b>Class of Service Number</b>	<ol style="list-style-type: none"> <li>1. <input type="text" value="1"/> to change the current setting.</li> <li>2. Enter the Class of Service Number (1–64).</li> <li>3. <input type="text" value="2"/> to accept.</li> </ol>
<b>Interview Mailbox Number</b>	<ol style="list-style-type: none"> <li>1. <input type="text" value="1"/> to change the current setting.</li> <li>2. Enter the Interview Mailbox Number.</li> <li>3. <input type="text" value="2"/> to accept.</li> </ol>
<b>All Calls Transfer To Mailbox (Change Logical Extension Status)</b>	<ol style="list-style-type: none"> <li>1. <input type="text" value="1"/> to change the current setting (enable or disable).</li> <li>2. <input type="text" value="2"/> to accept.</li> </ol>
<b>Message Waiting Lamp Notification</b>	<ol style="list-style-type: none"> <li>1. <input type="text" value="1"/> to change the current setting (enable or disable).</li> <li>2. <input type="text" value="2"/> to accept.</li> </ol>
<b>Device Notification for Unreceived Messages</b>	<ol style="list-style-type: none"> <li>1. <input type="text" value="1"/> to change the current setting (enable or disable).</li> <li>2. <input type="text" value="2"/> to accept.</li> </ol>
<b>External Message Delivery</b>	<ol style="list-style-type: none"> <li>1. <input type="text" value="1"/> to change the current setting (enable or disable). <ul style="list-style-type: none"> <li>• If set to "Enable", go to "<b>Prompt Mode</b>".</li> </ul> </li> <li>2. <input type="text" value="2"/> to accept.</li> </ol>
<b>Prompt Mode</b>	<ol style="list-style-type: none"> <li>1. <input type="text" value="1"/> for Primary.  <input type="text" value="2"/> for System.  <input type="text" value="3"/> for Caller Select. <ul style="list-style-type: none"> <li>• For System, enter the system prompt number (1–8).</li> </ul> </li> <li>2. <input type="text" value="4"/> to accept the current setting, then go to "<b>External Message Delivery</b>".</li> </ol>

Parameters	Steps
<b>Auto Forwarding</b>	<ol style="list-style-type: none"> <li>1. <input type="text" value="1"/> to change the current setting (enable or disable). <ul style="list-style-type: none"> <li>• If set to "Disable": <ol style="list-style-type: none"> <li>a. The following mailbox settings are skipped. <ul style="list-style-type: none"> <li>– Forwarding Mailbox Number</li> <li>– Forwarding Delay Time</li> <li>– Forwarding Mode</li> </ul> </li> <li>b. The Auto Forwarding parameter is the last parameter to be entered.</li> <li>c. To continue assigning or editing other mailboxes, go back to <b>STEP B</b>.</li> <li>d. To finish, enter <input type="text" value="*"/> <input type="text" value="*"/> .</li> </ol> </li> </ul> </li> <li>2. <input type="text" value="2"/> to accept.</li> </ol>
<b>Forwarding Mailbox Number</b>	<ol style="list-style-type: none"> <li>1. <input type="text" value="1"/> to change the current setting.</li> <li>2. Enter the forwarding mailbox number.</li> <li>3. <input type="text" value="2"/> to accept.</li> </ol>
<b>Forwarding Delay Time</b>	<ol style="list-style-type: none"> <li>1. <input type="text" value="1"/> to change the current setting.</li> <li>2. Enter the delay time, and <input type="text" value="#"/> .</li> <li>3. <input type="text" value="2"/> to accept.</li> </ol>
<b>Forwarding Mode</b>	<ol style="list-style-type: none"> <li>1. <input type="text" value="1"/> to change the current setting (Copy or Move).</li> <li>2. <input type="text" value="2"/> to accept, then go to "<b>Auto Forwarding</b>".</li> </ol>

### To delete a mailbox

The System Manager should delete mailboxes that are no longer needed. When another person accesses the Unified Messaging system, the action is automatically cancelled.

1. Log in to the System Manager's mailbox.
2.
3. Enter the mailbox number.
4.  to delete the mailbox.

### To reset a mailbox password

When a password is forgotten, the System Manager must reset the password before it can be reassigned by the subscriber.

1. Log in to the System Manager's mailbox.
2.
3. Enter the mailbox number.
4.  to delete the password.

## 2.2.1 System Manager Features



- The System Manager password cannot be reset here. The System Administrator can reset the System Manager password using Web Maintenance Console.
- After the password is reset, if the System Administrator has set "Default Password for New Mailboxes" to "Enable", the password will be set to the default password. If set to "Disable", the mailbox will have no password.

### ◆◆ Setting Class of Service (COS) Parameters

A Class of Service (COS) defines the set of system services available to the mailboxes assigned to it. There are 66 Classes of Service; they can be assigned to mailboxes by the System Administrator using Web Maintenance Console or by the System Manager using a telephone. COS No. 65 and No. 66 are assigned by default to the Message Manager and the System Manager respectively.



- If the Unified Messaging system is being programmed via Web Maintenance Console, the System Manager cannot set COS parameters. The system will announce, "Sorry, this function is not available".

#### To set COS parameters

Follow the steps detailed below to set the following Class of Service parameters:

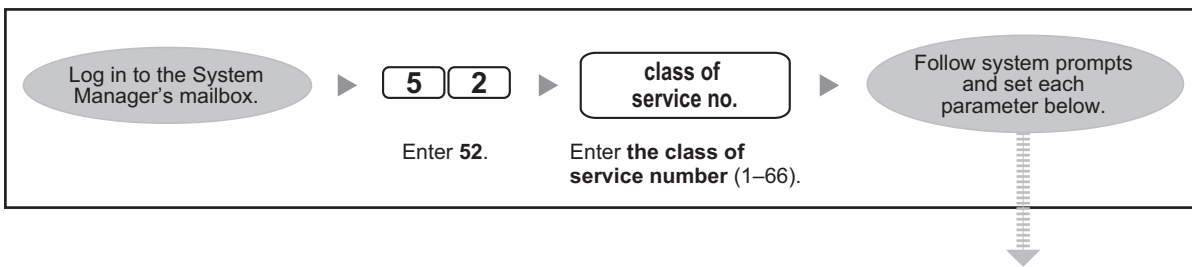

Parameters	Steps
<b>Personal Greeting Length<sup>†1</sup></b>	<ol style="list-style-type: none"> <li>1. <input type="text" value="1"/> to change the greeting length. <input type="text" value="2"/> to accept the current setting, then go to the next parameter.</li> <li>2. Enter the greeting length (1–360 s).</li> <li>3. <input type="text" value="2"/> to accept.</li> </ol>
<b>New Message Retention Time</b>	<ol style="list-style-type: none"> <li>1. <input type="text" value="1"/> to change the retention time. <input type="text" value="2"/> to accept the current setting, then go to the next parameter.</li> <li>2. Enter the retention time (a maximum of 30 days or 0: Unlimited).</li> <li>3. <input type="text" value="2"/> to accept.</li> </ol>
<b>Saved Message Retention Time</b>	<ol style="list-style-type: none"> <li>1. <input type="text" value="1"/> to change the retention time. <input type="text" value="2"/> to accept the current setting, then go to the next parameter.</li> <li>2. Enter the retention time (a maximum of 30 days or 0: Unlimited).</li> <li>3. <input type="text" value="2"/> to accept.</li> </ol>



Parameters	Steps
<b>Message Length</b>	<ol style="list-style-type: none"> <li>1. <input type="text" value="1"/> to change the message length. <input type="text" value="2"/> to accept the current setting, then go to the next parameter.</li> <li>2. Enter the message length (1–60 min or 0: Unlimited).</li> <li>3. <input type="text" value="2"/> to accept.</li> </ol>
<b>Total Message Time Available per Mailbox</b>	<ol style="list-style-type: none"> <li>1. <input type="text" value="1"/> to change the total message time. <input type="text" value="2"/> to accept the current setting, then go to the next parameter.</li> <li>2. Enter the total message time (1–600 min or 0: Unlimited).</li> <li>3. <input type="text" value="2"/> to accept.</li> </ol>
<b>Message Retrieval Order</b>	<ol style="list-style-type: none"> <li>1. <input type="text" value="1"/> to change the current setting (LIFO [Last In First Out] or FIFO [First In First Out]). <input type="text" value="2"/> to accept the current setting, then go to the next parameter.</li> <li>2. <input type="text" value="2"/> to accept.</li> </ol>
<b>Prompt Mode</b>	<ol style="list-style-type: none"> <li>1. <input type="text" value="1"/> for Primary. <input type="text" value="2"/> for System. <ul style="list-style-type: none"> <li>• For System, enter system prompt number (1–8).</li> </ul> </li> <li>2. <input type="text" value="3"/> to accept.</li> </ol>
<b>Delete Message Confirmation</b>	<ol style="list-style-type: none"> <li>1. <input type="text" value="1"/> to change the current setting (enable or disable).</li> <li>2. <input type="text" value="2"/> to accept.</li> </ol>
<b>Message Envelope Playback Mode</b>	<ol style="list-style-type: none"> <li>1. <input type="text" value="1"/> for Before. <input type="text" value="2"/> for After. <input type="text" value="3"/> for Require. <input type="text" value="4"/> to accept the current setting, then go to the next parameter.</li> <li>2. <input type="text" value="4"/> to accept.</li> </ol>
<b>Caller ID Callback</b>	<ol style="list-style-type: none"> <li>1. <input type="text" value="1"/> to change the current setting (enable or disable).</li> <li>2. <input type="text" value="2"/> to accept.</li> </ol>
<b>Play System Prompt after Personal Greeting<sup>1</sup></b>	<ol style="list-style-type: none"> <li>1. <input type="text" value="1"/> to change the current setting (enable or disable).</li> <li>2. <input type="text" value="2"/> to accept.</li> </ol>
<b>Use Call Waiting on Busy<sup>1</sup></b>	<ol style="list-style-type: none"> <li>1. <input type="text" value="1"/> to change the current setting (enable or disable).</li> <li>2. <input type="text" value="2"/> to accept.</li> </ol>
<b>Message Cancel for Live Call Screening<sup>1</sup></b>	<ol style="list-style-type: none"> <li>1. <input type="text" value="1"/> to change the current setting (enable or disable).</li> <li>2. <input type="text" value="2"/> to accept.</li> </ol>

## 2.2.1 System Manager Features

Parameters	Steps
<b>Intercom Paging Group<sup>*1</sup></b>	<ol style="list-style-type: none"> <li>1. <input type="button" value="1"/> to change the paging group. <input type="button" value="2"/> to accept the current setting, then go to the next parameter.</li> <li>2. Enter the group number (1–33).</li> <li>3. <input type="button" value="2"/> to accept.</li> </ol>
<b>Maximum Number of Caller IDs for Caller Name Announcement<sup>*1</sup></b>	<ol style="list-style-type: none"> <li>1. <input type="button" value="1"/> to change the current setting. <input type="button" value="2"/> to accept the current setting, then go to the next parameter.</li> <li>2. Enter the number of announcements that can be programmed by subscribers (1–30/0: None).</li> <li>3. <input type="button" value="2"/> to accept.</li> </ol>
<b>Mailbox Capacity Warning</b>	<ol style="list-style-type: none"> <li>1. <input type="button" value="1"/> to change the current setting. <input type="button" value="2"/> to accept the current setting, then go to the next parameter.</li> <li>2. Enter the warning threshold (1–60 min or 0: None).</li> <li>3. <input type="button" value="2"/> to accept.</li> </ol>
<b>Personal Greeting for Caller ID<sup>*1</sup></b>	<ol style="list-style-type: none"> <li>1. <input type="button" value="1"/> to change the current setting (enable or disable).</li> <li>2. <input type="button" value="2"/> to accept.</li> </ol>
<b>Caller ID Screen<sup>*1</sup></b>	<ol style="list-style-type: none"> <li>1. <input type="button" value="1"/> to change the current setting (enable or disable).</li> <li>2. <input type="button" value="2"/> to accept.</li> </ol>
<b>Call Transfer to Outside<sup>*1</sup></b>	<ol style="list-style-type: none"> <li>1. <input type="button" value="1"/> to change the current setting (enable or disable).</li> <li>2. <input type="button" value="2"/> to accept.</li> </ol>
<b>Subscriber Tutorial<sup>*1</sup></b>	<ol style="list-style-type: none"> <li>1. <input type="button" value="1"/> for Normal Mode. <input type="button" value="2"/> for Simplified Mode. <input type="button" value="3"/> to disable.</li> </ol>
<b>Notify of Transfer</b>	<ol style="list-style-type: none"> <li>1. <input type="button" value="1"/> to change the current setting (enable or disable).</li> <li>2. <input type="button" value="2"/> to accept.</li> </ol>
<b>Directory Listing<sup>*1</sup></b>	<ol style="list-style-type: none"> <li>1. <input type="button" value="1"/> to change the current setting (enable or disable).</li> <li>2. <input type="button" value="2"/> to accept.</li> </ol>
<b>Auto Receipt</b>	<ol style="list-style-type: none"> <li>1. <input type="button" value="1"/> to change the current setting (enable or disable).</li> <li>2. <input type="button" value="2"/> to accept.</li> </ol>
<b>Autoplay New Message</b>	<ol style="list-style-type: none"> <li>1. <input type="button" value="1"/> to change the current setting (enable or disable).</li> <li>2. <input type="button" value="2"/> to accept.</li> </ol>
<b>First Playback Urgent Messages</b>	<ol style="list-style-type: none"> <li>1. <input type="button" value="1"/> to change the current setting (enable or disable).</li> <li>2. <input type="button" value="2"/> to accept.</li> </ol>

Parameters	Steps
<b>Announce Message Transferred Information</b>	<ol style="list-style-type: none"> <li>1. <input type="text" value="1"/> to change the current setting (enable or disable).</li> <li>2. <input type="text" value="2"/> to accept.</li> </ol>
<b>Caller ID Announcement</b>	<ol style="list-style-type: none"> <li>1. <input type="text" value="1"/> to change the current setting (enable or disable).</li> <li>2. <input type="text" value="2"/> to accept.</li> </ol>
<b>Announce Option Menu After Erasing Messages</b>	<ol style="list-style-type: none"> <li>1. <input type="text" value="1"/> to change the current setting (enable or disable).</li> <li>2. <input type="text" value="2"/> to accept.</li> </ol>
<b>New Message Length Announcement</b>	<ol style="list-style-type: none"> <li>1. <input type="text" value="1"/> to change the current setting (enable or disable).</li> <li>2. <input type="text" value="2"/> to accept.</li> </ol>

<sup>1</sup> Not available for COS No. 65 (Message Manager) and COS No. 66 (System Manager)

## ◆◆ Remote Time Service Mode Setting

You can set the time service mode from an outside telephone even when you are away from the office.

### To set the time service mode

1. Log in to the System Manager's mailbox.
2.
3. Enter the tenant number and .
4.  to change.
5. Select the desired Time Service mode entry.
  - to set Day mode.
  - to set Night mode.
  - to set Lunch mode.
  - to set Break mode.

## ◆◆ Changing the Company Greeting and Incoming Call Service Setting

When the Unified Messaging system answers calls, it greets the callers with a Company Greeting and then activates an Incoming Call Service. The System Manager or System Administrator can choose:

- The appropriate company greeting for each time mode (Day, Night, Lunch, and Break) of each call service. The default company greeting is Company Greeting 1. If the Company Greeting 1 is not recorded, nothing will not be played.
- The desired Incoming Call Service for each time mode of each call service. The default service is Custom Service 1 for Day/Lunch/Break mode, and Custom Service 2 for Night mode. If the Custom Service is not recorded, Automated Attendant service will be played.
- The assignment of the Service Group for each Unified Messaging extension number/Trunk.



- If the Unified Messaging system is being programmed via Web Maintenance Console, the System Manager cannot change the Company Greeting and Incoming Call Service Setting. The system will announce, "Sorry, this function is not available".

### To change the service group setting

1. Log in to the System Manager's mailbox.
2.
3.  to change the Service Group setting.
4. Enter the Service Group Number (1–64).
5. Select the desired Time Service period entry.
  - for Day Time service.
  - for Night Time service.
  - for Lunch Time service.
  - for Break Time service.
6.  to change the Company Greeting.
  - to change the Incoming Call Service, then go to step 10.
7.  to change the setting.
  - to accept.
8. Select the desired setting entry.
  - to change a Company Greeting number.
  - to set the System Greeting, then go to step 13.
  - to disable, then go to step 13.
9. Enter a Company Greeting number (1–32), then go to step 13.
10.  to change the setting.
  - to accept.
11. Select the desired setting entry.
  - to set Voice Mail Service, then go to step 13.
  - to set Automated Attendant Service, then go to step 13.
  - to set Custom Service.
  - to set Interview Service.
  - to set Transfer to Mailbox.
12. Enter the Custom Service number (1–200), or the Mailbox number.
13.  to accept.

### To change the service group assignment

1. Log in to the System Manager's mailbox.
2.
3.  to change the Service Group Assignment.
4. Enter the Unified Messaging extension number.
5.  to change the service group, then go to step 6.
  - to accept.
6. Enter the Service Group Number (1–64).
7.  to accept.

## ◆◆ Broadcasting Messages

The System Manager can deliver a message to multiple subscribers with one operation. Messages can be sent to all subscribers (Broadcasting Message feature) or to specified subscribers only. When delivering a message to specified subscribers, the System Manager can receive verification when the recipients listen to the message.



- The System Manager can set the date and time when a message is delivered. The date can be set up to one month in advance.

### To deliver messages to all mailboxes (Broadcasting Messages)

The Broadcasting Messages feature allows the System Manager to deliver a message to multiple subscribers with one operation. Broadcast messages have priority over other regular or urgent messages, but otherwise are treated like regular messages. This feature is useful when informing subscribers about the current system status such as remaining capacity, requesting that unnecessary messages be erased, etc.

1. Log in to the System Manager's mailbox.
2.
3.  to record a broadcast message.
4.  to end recording.
5.  to accept.

### To deliver messages to specified mailboxes

Use this feature to deliver the same message to one or more subscribers by specifying their mailbox numbers.

1. Log in to the System Manager's mailbox.
2.
3. Enter the mailbox number of the intended recipient.
  - Enter by name by pressing   first. Use a Mailbox Group by specifying its number.
4.  to accept.
5.  to record a message.
  - Enter  to add mailbox numbers. Enter  to review the mailing list. Enter  to cancel message transfer.
6.  to end recording.
7.  to accept.
8.   to specify the delivery time.
  - Enter   to send the message immediately, then go to step 13.
9. Enter the desired delivery time, then  .
10.  for AM.  
 for PM.
  - This option may not be available if the system is programmed to use 24-hour time.
11. Enter the day of the month for delivery, then  .  
Example:
  - If today is February 16 and you enter    , the message will be delivered tomorrow.
  - If today is February 16 and you enter   , the message will be delivered on March 5.
12.  to accept.
13.  to make the message urgent.  
 to continue.
14.  to make the message private.  
 to continue.

### ◆◆ Changing the System Manager's Password

The System Manager must enter the System Manager password in order to log in before performing any System Manager tasks. In order to ensure system security, we recommend selecting a long (max. 16 digits) password that cannot be easily guessed.



- If the Unified Messaging system is being programmed via Web Maintenance Console, the System Manager cannot change the System Manager password. The system will announce, "Sorry, this function is not available".

**To change the System Manager's password**

1. Log in to the System Manager's mailbox.
2.
3.  to change the mailbox password.  
 to accept the current setting.
4. Enter the desired password, then  .
5.  to accept.

## 2.2.2 Message Manager Features

The Message Manager can maintain the general delivery mailbox, change notification settings, record/delete prompts, etc.

- ◆◆ Logging in to the Message Manager's Mailbox
- ◆◆ Managing the General Delivery Mailbox
- ◆◆ Setting Up Message Waiting Notification
- ◆◆ Customising the Message Manager's Mailbox
- ◆◆ Recording Messages
- ◆◆ Remote Call Forwarding Set
- ◆◆ Setting the Timed Reminder
- ◆◆ Day/Night Recording Menu
- ◆◆ Recording an Emergency Greeting
- ◆◆ List of Prompts for VM and AA Service

### ◆◆ Logging in to the Message Manager's Mailbox

The procedures described in this section require the Message Manager to use a telephone, however, many of these procedures can also be performed using a PC with Web Maintenance Console. For more information, consult your dealer.

In order to perform these procedures with a telephone, the Message Manager must log in before performing any Message Manager tasks. To log in as the Message Manager, 3 items of information must be known: the UM group's floating extension number to access the Unified Messaging system, the Message Manager's mailbox number, and the Message Manager's mailbox password.

- The Message Manager's mailbox number is 998 (default) depending on the mailbox number length specified in system programming.
- The Message Manager's password can be assigned by the System Administrator using Web Maintenance Console or by the Message Manager using his or her extension telephone (refer to "◆◆ Customising the Message Manager's Mailbox").



- Before the Message Manager can perform Message Management (recording Custom Service Menus, messages, etc.), "Message Manager Access from Telephone" must be enabled and "Password for Message Manager (Up to 16 numeric digits)" must be set by the System Administrator using Web Maintenance Console.
- After logging in, the system will announce the number of total messages, the number of new messages, or the length of new messages. These announcements depend on the mailbox settings and COS settings for the Message Manager.
- If there are new messages in the mailbox, the messages will be played automatically. The Message Manager can listen to them continuously without listening to the system prompts. This feature is only available when "Autoplay New Message" is activated for the Message Manager's COS.



- For more information on logging in, refer to "◆◆ Logging in to Your Mailbox".
- **Manager Service switching**  
You can switch mailboxes simply by pressing **##** from the subscriber service menu, in the following order:

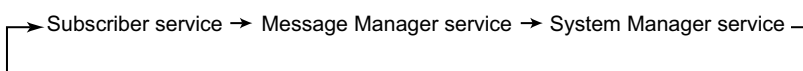





- **For KX-UT series SIP phone and S-PS users:**  
When using the MESSAGE button, please press the MESSAGE button before going off-hook.

### Manual log-in

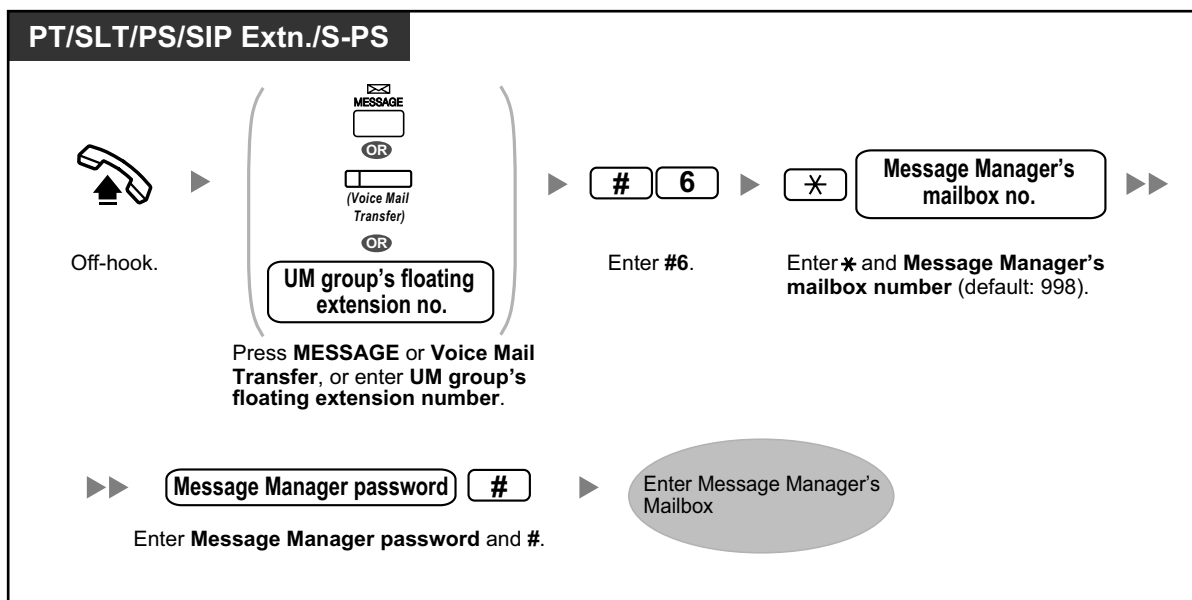

### Automatic log-in

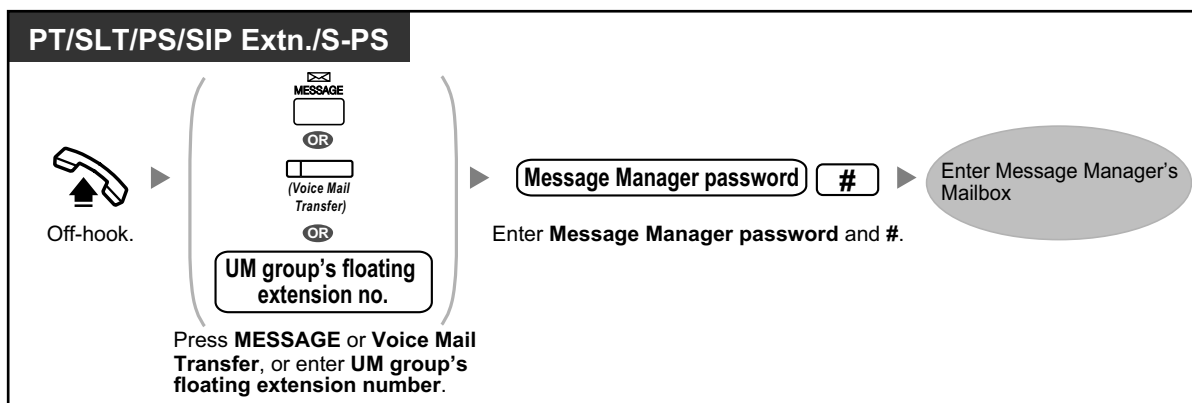

- This feature may be disabled by the System Administrator for your mailbox.

### Remote automatic log-in

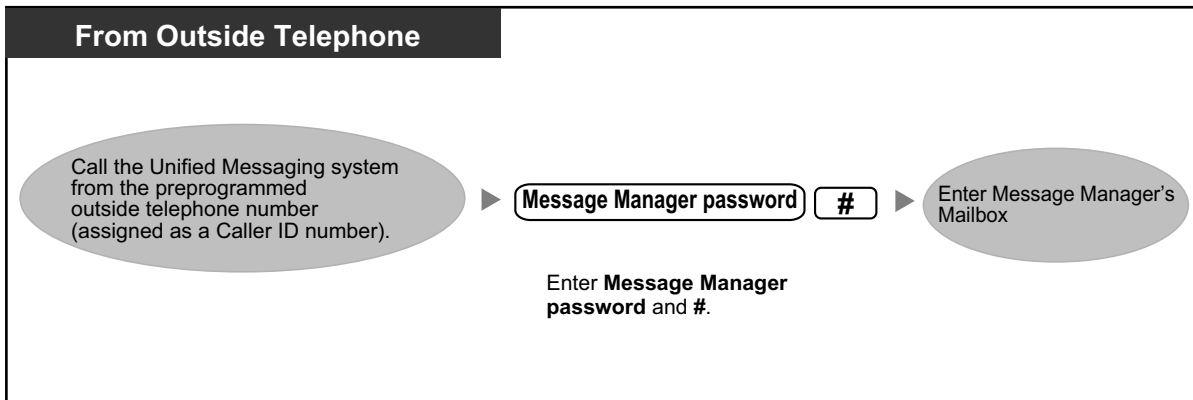

#### **CAUTION**

- It is strongly recommended that a password of 16 numbers be used for maximum protection against unauthorised access.
- To avoid unauthorised access to the PBX, keep the password secret. If it becomes known to others, the PBX may be misused.
- Change the password periodically.

#### **Notice**

- When disabling the password requirement, ensure that an unauthorised third-party is not allowed access to your extension.

### ◆◆ Managing the General Delivery Mailbox

One of the Message Manager's functions is to check the General Delivery Mailbox for messages and transfer them to the appropriate mailbox or mailboxes (Mailbox Groups may be used). This can be done at any time using the telephone.

#### **To listen to messages**

The Message Manager can monitor the status of the General Delivery Mailbox through his or her mailbox. He or she can listen to the messages stored in the General Delivery Mailbox and, if necessary, transfer them to their intended recipients.

1. Log in to the Message Manager's mailbox.
2.  to receive the message.
3. Enter the desired number.
  - to listen to new messages.
  - to listen to old messages.
  - to listen to deleted messages.
4. The system plays each message, identifying the sender and indicating when the message was recorded.
  - to repeat this message.
  - to replay the previous message.
  - to play the next message.
  - to delete this new/old message or recover this deleted message.
  - to reply to this new/old message.
  - to transfer this new/old message.
  - to listen to the message envelope.
    - System programming determines if the message envelope is played before each message, after each message, or only when you press .
  - to rewind a voice message during playback.
  - to pause or restart the message during playback.
  - to increase playback volume during playback.
  - to set a Bookmark for the voice message during voice message playback.
  - to start playback at the Bookmark for the voice message.
  - to fast-forward during playback.
  - to save as new (when the new message is listened).
  - to listen to the entire menu.

### To transfer messages

Messages left in the General Delivery Mailbox should be transferred to their intended recipients on a regular basis. The Message Manager can add his or her own voice comments when necessary. When a message is transferred, the original message is not deleted from the General Delivery Mailbox; it must be deleted manually.

1. Start with step 1–5 in "To listen to messages" above.
  - while listening to the message to transfer.
2. Enter the destination mailbox number.
3.  to accept.
4.  to record a comment.
  - Enter  to transfer messages without comment. Enter  to add a mailbox number. Enter  to review the Mailing List.
5.  to end recording.
6.  to accept.

### ◆◆ Setting Up Message Waiting Notification

The Unified Messaging system can notify the Message Manager when unplayed messages are waiting in his or her mailbox by turning on the message waiting lamp and/or calling an external device (i.e., telephone). The Unified Messaging system can also send notification via e-mail if the System Administrator has enabled this feature.

#### To set notification by Message Waiting Lamp

The system lights the message waiting lamp on the Message Manager's extension when a new message is recorded in the Message Manager's mailbox.



- Extensions assigned as operators can be called by dialling "9/0 (default)". However, when setting this feature the extension number (not "9/0 [default]") must be specified. For more information, consult your System Administrator.
- When a 6-line display PT is used, the number of new (unplayed) messages will be displayed while the message waiting lamp is lit. If the telephone has a Message button, the Message light will also turn on when you receive a new message.

1. Log in to the Message Manager's mailbox.
2.
3.  to change the Message Waiting Lamp Notification Status.
4.  to change.  
 to accept.

#### Setting Notification by External Device

The system calls the preprogrammed telephone number when a new message is recorded in the Message Manager's mailbox. Set the following parameters as needed.

#### To assign notification numbers

A maximum of 3 telephone numbers can be set for message notification. It is also possible to have the caller select whether or not he or she wishes to enter a callback number.

1. Log in to the Message Manager's mailbox.
2.
3.  to assign a telephone number.
4. Enter the desired number.
  - to change the first telephone number.
  - to change the second telephone number.
  - to change the third telephone number.
5.  to accept.
6. Dial the telephone number.
7.  to accept.
8.  to change the telephone number.
  - to accept.
  - to review.
  - to add more digits.
  - to insert a pause.
  - to insert a wait for dial tone.

### To set device status

For each device, the notification is enabled or disabled according to a preset schedule. The Message Manager can **enable** a device according to a schedule. However, the System Administrator must first assign a destination number to the desired device.

1. Log in to the Message Manager's mailbox.
2.
3. Enter the device number (1–6).
  - Device number 4, 5, or 6 is used to specify a device number that is "Device No. 1, 2, or 3" for "E-mail/Text Message Device" in Web Maintenance Console.
  - If a telephone number has not been assigned to the selected device number 1, 2, or 3, you cannot set the device status. Refer to "To assign notification numbers" to assign a telephone number.
4. Select the desired message type.
  - to notify all messages.
  - to notify urgent messages.
5. Select when the device will be used for message notification.
  - for schedule (a notification is sent each time a message is received, but only during the times programmed by the System Administrator).
  - for continuously.
  - for disable (notifications are not sent).

## ◆◆ Customising the Message Manager's Mailbox

The Message Manager can customise the Message Manager's mailbox by changing the following parameters.

- The Message Manager's mailbox password
- The extension numbers of Operator 1, 2, and 3

## 2.2.2 Message Manager Features

---

- Telephone numbers 1 and 2 used for call forwarding destinations when Remote Call Forwarding is set to an outside line



- If the Unified Messaging system is being programmed via Web Maintenance Console, the Message Manager cannot customise his or her mailbox. The system will announce, "Sorry, this function is not available".

- **Message Manager's Password:**

The Message Manager must enter the Message Manager password in order to log in before performing any Message Manager tasks. In order to ensure system security, we recommend selecting a long (max. 16 digits) password that cannot be easily guessed.

- **Operator's Extensions:**

When callers require help, they can dial the operator call number to be transferred to an operator. A maximum of 3 operators can be programmed for each time mode; these operators are not necessarily the same as the operator extensions programmed for the PBX. The extension assigned as Operator 1 for the day mode is designated as the Message Manager.

- **Telephone Numbers 1 and 2 for Remote Call Forward to Outside:**

After programming/changing the telephone numbers used for Remote Call Forward to Outside, the Message Manager must reset the remote call forwarding setting (refer to "◆◆ Remote Call Forwarding Set"), even if it was already enabled. Telephone numbers set here will not be effective until remote call forwarding is reset. If you do not reset remote call forwarding, calls will be forwarded to the old telephone numbers.

### To customise the message manager's mailbox

1. Log in to the Message Manager's mailbox.
2.
3.  to change the password.  
 to accept.
4. Enter the password, then .
5.  to accept.
6. Enter the desired number.  
 to change or assign the operator's extension.  
 to accept.  
 to delete, then go to step 9.
  - Operator 1's extension number cannot be deleted.
7. Dial the extension number.
8.  to accept.
9. Repeat steps 6–8 to assign or to delete the extension number for the Day, Night, Lunch and Break Modes for each operator.
10. Enter the desired number.  
 to change or assign the telephone number 1 setting.  
 to accept the current setting, then go to step 13.
11. Dial the telephone number (  –  ,  [max. 32 digits]).
  - Make sure you begin the telephone number with an outside line access number (to seize an outside line).
12.  to accept.
13. Enter the desired number.  
 to change or assign the telephone number 2 setting.  
 to accept the current setting.
14. Dial the telephone number (  –  ,  [max. 32 digits]).
15.  to accept.

## ◆◆ Recording Messages

The Message Manager is responsible for recording various system messages (menus, voice labels, system prompts, and system caller names) and is also responsible for maintaining the following:

- **Company Greetings:**  
A maximum of 32 company greetings for business/non-business and lunch/break hours as well as holidays can be selected, recorded, or deleted as necessary.
- **Company Name**
- **Custom Service Menus:**  
A maximum of 200 custom service menus can be recorded. These menus guide callers to the services they require without the need for a human operator.
- **Voice Labels:**  
A maximum of 20 Mailbox Groups can be created by the System Administrator. Each list can have a voice label.
- **System Prompts:**  
The Message Manager can change system prompts by recording new prompts and restoring them.

## 2.2.2 Message Manager Features

---

- **Multilingual Selection Menu:**  
With this menu, callers can select the language they prefer for voice guidance. For example, the Message Manager can record a menu that announces:  
"For English, press 7."  
"For French, press 8."
- **The System Caller Names:**  
A maximum of 200 Caller ID numbers can be registered by the System Administrator. The Message Manager is responsible for recording a name for each Caller ID number.
- **On Hold Announcement Menu:**  
With this menu, callers in a queue can listen to the announcement or music while they are on hold.
  - If the Unified Messaging system is being programmed via Web Maintenance Console, the Message Manager cannot record any messages. The system will announce, "Sorry, this function is not available".



### To record menus and voice labels

1. Log in to the Message Manager's mailbox.
2.  to record messages.
3. Enter the desired number to record.
  - for Company Greetings.
  - for Company Name.
  - for Custom Service Menus.
  - for Voice Labels for Mailbox Groups.
  - for System Prompts.
  - for Multilingual Selection Menu.
  - for System Caller Names.
  - for On Hold Announcement Menu.
4. For the item selected in step 3, follow these steps:
  - a. **For Company Greetings:** Enter the Company Greeting Number (1–32).
  - b. **For the Company Name:** Go to step 5.
  - c. **For Custom Service Menus:** Enter a Custom Service Number (1–200).
    - Enter  to record the Custom Service exit prompt.
  - d. **For Voice Labels:** Enter the number of the Mailbox Group to be labelled. (The System Administrator assigns list numbers.)
  - e. **For the Multilingual Selection Menu:** Go to step 5.
  - f. **For the On Hold Announcement Menu:** Go to step 5.
5.  to change the message.
  - If a message has not yet been recorded, go to step 7.
6.  to record a message.
  - to erase the current message, then go to step 3 or 4.
7.  to end recording.
8.  to accept.
9. Repeat steps 4–8 to record other Company Greetings, Custom Service Menus, and/or Voice Labels.



### To record system prompts

1. Log in to the Message Manager's mailbox.
2.   to record messages.
3. Enter the system prompt number you want to change.
4. To change specific prompts, go to step 5.  
To change all prompts one after another without reviewing the current recording, go to step 6.
5. To change specific prompts:
  - a.
  - b. Enter the prompt number you want to change (refer to "◆◆ List of Prompts for VM and AA Service").
  - c. The system plays the prompt number and its prompt. If a prompt has not yet been recorded, the system plays the system prompt. If a prompt is turned off, "The prompt is now turned off" will play before the prompt.
  - d.  to record.
  - e.  to end recording.
  - f.  to accept.
  - g. Repeat steps 5b to 5f to record other prompts.
6. To change all prompts one after another.
  - a.
  - b. Enter the prompt number you want to change.
  - c.  to change.
  - d.  to end recording.
  - e.  to accept.
  - f. The system plays the next prompt number.
  - g. Repeat steps 6c to 6f to record other prompts.



- It is possible to restore the original system prompts. Consult your System Administrator about this feature.

### To record system caller names

Before recording System Caller Names, the associated telephone numbers must first be programmed using Web Maintenance Console. For more information, consult your System Administrator.

1. Log in to the Message Manager's mailbox.
2.
3.  to modify system caller names.
4. Enter the Caller ID List Number (1–200).
  - Guidance is "Caller Name Announcement number".
  - Enter  to go to step 3.
5.  to change the name.
  - If a name has not yet been recorded for this Caller ID number, go to step 6.
  - Enter  to accept or  to erase the current name, then go to step 4.
6.  to end recording.
7.  to accept.
8. Repeat steps 4–7 to record names for other Caller ID List numbers.

### ◆◆ Remote Call Forwarding Set

The Message Manager can program his or her extension from a remote location to forward various types of calls to the desired extension or an outside telephone. There are 6 forwarding settings available:

- **FWD All:**  
Forwards all incoming calls to a specified extension number.
- **FWD Busy:**  
Forwards all incoming calls to a specified extension number when the line is busy.
- **FWD No Answer:**  
Forwards all incoming calls to a specified extension number when there is no answer.
- **FWD Busy or No Answer:**  
Forwards all incoming calls to a specified extension number when the line is busy or there is no answer.
- **FWD to Outside:**  
Forwards all incoming calls to telephone number 1 or 2 (preprogrammed in the Mailbox Setting), or to any other telephone number.
- **FWD Cancel:**  
Cancels the forwarding setting.



- This feature is not available when the Message Manager's extension (assigned for Operator 1 in the Day Mode) is "default". In this case, it should be changed to the operator's extension number. For more information, consult your System Administrator.
- In order to use the FWD to Outside option, the ability to forward calls to trunks must be enabled through system programming.
- Before setting Remote Call Forwarding to Outside, you should first store up to 2 destination telephone numbers (refer to "◆◆ Customising the Message Manager's Mailbox").

### To assign Remote Call Forwarding set

1. Log in to the Message Manager's mailbox.
2.
3. Select the desired forwarding setting.
  - for FWD All.
  - for FWD Busy.
  - for FWD No Answer.
  - for FWD Busy or No Answer.
  - for FWD to Outside, then go to step 6.
  - for FWD Cancel, then go to step 9.
4. Enter the extension number.
5.  to accept the extension number, then go to step 10.
  - Enter  to change the extension number, then go to step 4.
6. Enter the desired number.
  - for telephone number 1, then go to step 8.
  - for telephone number 2, then go to step 8.
  - for another telephone number.
  - Before you can forward your calls to telephone number 1 or 2, you should first store the telephone numbers you plan on using with this feature.
7. Enter the telephone number (  –  ,  ). (max. 32 digits)
  - Make sure you begin the telephone number with an outside line access number (to seize an outside line).
8.  to accept, then go to step 10.
  - Enter  to change the telephone number, then go to step 6.
9.  to accept.
10. The new settings are transmitted to the system. If the setting has been completed properly, you will hear: "Call forwarding accepted" or "Call forwarding is cancelled" as appropriate.



- If the system announces, "Call forwarding not accepted. Please check the destination number.", the forwarding setting has not been completed properly, possibly because a nonexistent extension number has been entered as the destination. For more information, consult your System Administrator.

### ◆◆ Setting the Timed Reminder

The Message Manager can set or cancel the Timed Reminder. The telephone will ring at the set time according to the set mode (Once/Daily).



- This feature is not available for PSs or S-PSs.
- This feature is not available when the Message Manager's extension (assigned for Operator 1 in the Day Mode) is "default". In this case, it should be changed to the operator's extension number. For more information, consult your System Administrator.

### To set/cancel

1. Log in to the Message Manager's mailbox.
2.
3. Enter the desired number.  
 to change the setting.  
 to accept, then go on-hook to finish.  
 to cancel (turn off), then go on-hook to finish.
4. Enter the desired time, then .
5. Enter the desired number.\*  
 for AM.  
 for PM.
6. Enter the desired number.  
 to set once.  
 to set daily.
7.  to accept.



- \* This option may not be available if the system is programmed to use 24-hour time. The time format (12 or 24 hour) is determined by the "Position of "AM/PM" in Time Stamp" setting. For more information, consult your System Administrator.

### ◆◆ Day/Night Recording Menu

A Day and Night Menu can be recorded as "Custom Service 1–2" directly from the top menu.

### To record

1. Log in to the Message Manager's mailbox.
2.  for Custom Service 1 Menu (Day).  
 for Custom Service 2 Menu (Night).
3.  to change the message.
4.  to record a message.
5. Record the message.
6.  to end recording.
7.  to accept.



- This feature is not available when the "Quick Menu and Greeting Recording" setting is disabled for the Message Manager's mailbox. For more information, consult your System Administrator.



- **Direct Service Access**  
If Direct Service Access is set in Mailbox Settings, you can access this feature directly by dialling a specific Unified Messaging extension number from your extension. Automatic login must be enabled to use Direct Service Access (refer to "Automatic log-in"). For details about these Unified Messaging extension numbers, consult your System Administrator.

## ◆◆ Recording an Emergency Greeting

An emergency greeting can be recorded as "Company Greeting 1" directly from the top menu. The emergency greeting can be used in times such as when the company must be closed due to bad weather.

### To record

1. Log in to the Message Manager's mailbox.
2.
3.  to change the message.
4.  to record a message.
5. Record the greeting.
6.  to end recording.
7.  to accept.



- This feature is not available when the "Quick Menu and Greeting Recording" setting is disabled for the Message Manager's mailbox. For more information, consult your System Administrator.



- **Direct Service Access**  
If Direct Service Access is set in Mailbox Settings, you can access this feature directly by dialling a specific Unified Messaging extension number from your extension. Automatic login must be enabled to use Direct Service Access (refer to "Automatic log-in"). For details about these Unified Messaging extension numbers, consult your System Administrator.

## ◆◆ List of Prompts for VM and AA Service

There are over 1000 system prompts in the Unified Messaging system. These prompts can be customised by re-recording them to change their content, or can be recorded in various languages. The maximum length of a prompt is fixed at 6 minutes.

When recording prompts in other languages, most often it is not necessary to record all prompts contained in the Unified Messaging system; recording over 1000 system prompts is a big undertaking. When a caller is connected to AA service or VM service, most likely he or she will only hear a small selection of the following prompts. Therefore, it is necessary only to record (or modify) the prompts that callers will hear.

Please change prompts to suit the application. For example, prompt no. 1211 could be re-recorded to announce, "Thank you for calling ABCD Travel", instead of "Welcome to the Unified Messaging System". It is possible to record the prompts you wish to modify on your computer in .wav format and upload them to the Unified Messaging system. For more information, consult your System Administrator.

### Prompts Common to VM and AA Services

Prompt No.	Modifiable Prompts
363	Good afternoon
364	Good evening
365	Good morning
1211	Welcome to the Unified Messaging System
973	To enter by name, press the hash sign and 1
974	To enter by name, press the pound sign and 1

## 2.2.2 Message Manager Features

---

Prompt No.	Modifiable Prompts
221	Enter the first 3 or 4 letters of the person's last name
326	For 'Q', press 7
327	For 'Z', press 9
693	Sorry, there are no more matching names
701	Sorry, this name cannot be found
392	Incorrect entry
842	To call the operator, press 0
90	Calling the operator
599	Please wait a moment
1201	Welcome to the general delivery mailbox
596	Please leave a message at the tone
966	To end recording, hang up or press 1 for more features
1026	To pause and restart recording, press 2
1060	To review, press 1
818	To accept, press 2
979	To erase and try again, press 3
829	To add, press 4
978	To erase and exit, press ✕
1018	To make this message private, press 1
558	Otherwise, press 2
733	Thank you for calling

### VM Prompts

Prompt No.	Modifiable Prompts
593	Please enter your party's mailbox number
219	Enter the first 3 or 4 letters of the person's first name
220	Enter the first 3 or 4 letters of the person's first or last name
1019	To make this message urgent, press 1

### AA Prompts

Prompt No.	Modifiable Prompts
592	Please enter your party's extension
1224	You have a call
690	Sorry, no one is available to answer the call

---

Prompt No.	Modifiable Prompts
1006	To leave a message, press 1
971	To enter another extension, press *
698	Sorry, this line is busy
388	If you would like to hold, press 1
847	To cancel holding, press 2 now. Otherwise, I'll try your party again.

## 2.2.2 Message Manager Features

---



---

## **Section 3**

# ***Customising Your Phone & System***

*This section shows you how to customise your individual telephone or PBX according to your needs. Find the desired setting and program as necessary.*

# 3.1 Customising Your Phone (Personal Programming)

## 3.1.1 Customising Your Phone (Personal Programming)

You can customise your telephone features. For example, you can change the initial settings or button features according to your needs.

- Assigning an Extension PIN to Your Extension (Extension PIN [Personal Identification Number])



- If you change your desk and extension, refer to "1.13.1 Walking Extension".

### Assigning an Extension PIN to Your Extension (Extension PIN [Personal Identification Number])

You can assign a password to each extension. The following features require an extension PIN.

1. Screening calls (Live Call Screening [LCS])
2. Prohibiting other people from seeing your personal speed dialling directory, call log, SVM log, and from playing back the voice messages in your message box (Display Lock)
3. Using the same settings as your extension at other extensions (Walking Extension)
4. Remote Control Operation (Walking COS)
5. Extension Dial Lock Clear

To set

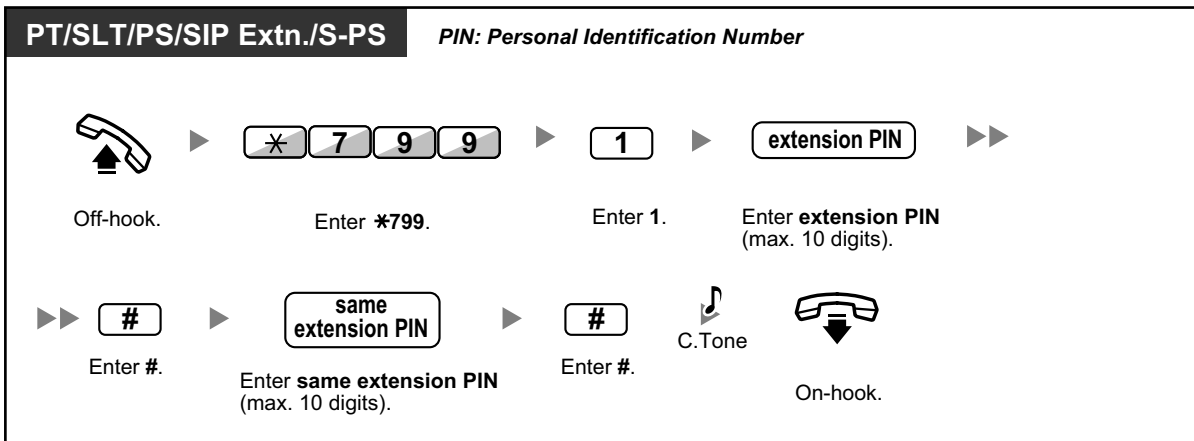

To cancel

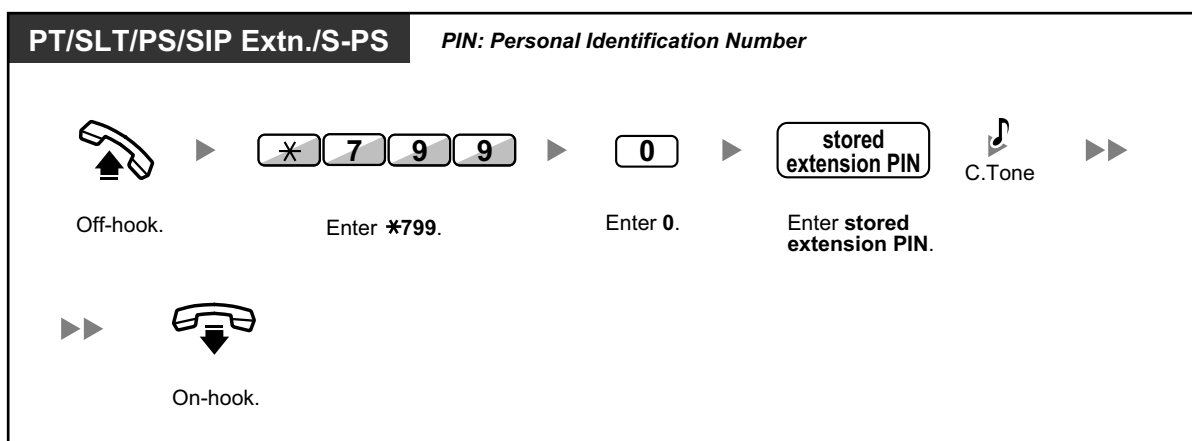

### CAUTION

There is a risk that fraudulent telephone calls will be made if a third party discovers your password (extension PIN).

The cost of such calls will be billed to the owner/renter of the PBX.

To protect the PBX from this kind of fraudulent use, we strongly recommend:

- a. Keeping your PIN secret.
  - b. Selecting a complex, random PIN that cannot be easily guessed.
  - c. Changing your PIN regularly.
- Valid numbers for an extension PIN are "0" through "9".
  - If the wrong extension PIN is entered a preprogrammed number of times, the PIN is locked.
  - If you forget your extension PIN or your extension PIN is locked, your manager can clear the extension PIN and extension PIN lock.

### 3.1.2 Settings on the Programming Mode

You can programme features using the programming mode for a PT or PS.

- ◆◆ Setting Features
- ◆◆ Clearing Features



- To exit at any time, lift the handset.
- To enter the programming mode when using a PS, refer to the documentation for your PS.
- For KX-UT series SIP phone users and S-PS users: You cannot programme the following features using a KX-UT series SIP phone or an S-PS. These features are programmed via Web Maintenance Console. For more information, consult your System Administrator.
- **For KX-NT511 users:**  
Since there is no PROGRAM button on a KX-NT511, press and hold flexible button 1, 2, or 3 instead.

#### ◆◆ Setting Features

The default settings are shown in bold letters. For later reference, place a check mark in the boxes below to indicate your customised setting.

**Notice**



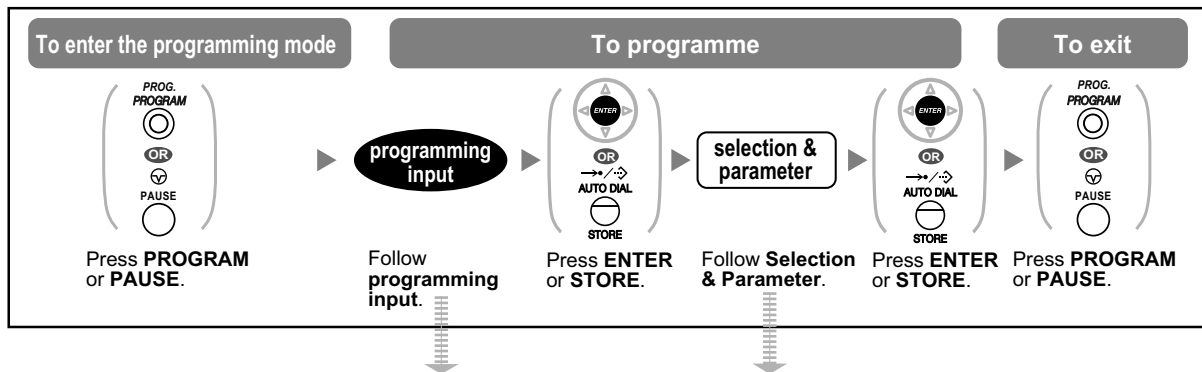

The default value may vary depending on country/area.



Item	Programming Input	Selection & Parameter
Your extension information	<input type="text" value="0"/> <input type="text" value="0"/>	The display shows your PT or PS's extension number. <Example> Ext 101
<b>Display Contrast Selection<sup>1</sup></b> Preferred display contrast level from the 4 levels available	<input type="text" value="0"/> <input type="text" value="1"/>	<input type="text" value="1"/> <input type="checkbox"/> Light
		<input type="text" value="2"/> <input type="checkbox"/> Little Light
		<input type="text" value="3"/> <input type="checkbox"/> <b>Little Dark</b>
		<input type="text" value="4"/> <input type="checkbox"/> Dark

Item	Programming Input	Selection & Parameter	
<b>Display Language Selection</b> Which display language do you prefer?	0 2 / 	1	<input type="checkbox"/> English
		2	<input type="checkbox"/> 2nd Language
		3	<input type="checkbox"/> 3rd Language
		4	<input type="checkbox"/> 4th Language
		5	<input type="checkbox"/> 5th Language
<b>Display Switching Mode</b> Would you like the call duration to be shown automatically on the display when answering an outside call?	0 3	0	<input type="checkbox"/> No—Manual (The display keeps showing all of the outside caller's information unless you change it to the call duration manually.)
		1	<input type="checkbox"/> <b>Yes—Automatic (The first line of the display will change to the call duration automatically when you answer an outside call.)</b>
<b>Display Backlight Selection</b> <sup>*1*2</sup> Would you like to turn on the display backlight of the telephone?	0 4	0	<input type="checkbox"/> <b>Yes—Automatic</b>
		1	<input type="checkbox"/> Yes—always On
		2	<input type="checkbox"/> No—always Off
<b>Self Labelling Display Contrast</b> Preferred display contrast level from the 4 levels available for Self Labelling (KX-NT366/KX-NT553/KX-NT556 only)	0 5	1	<input type="checkbox"/> Light
		2	<input type="checkbox"/> Little Light
		3	<input type="checkbox"/> <b>Little Dark</b>
		4	<input type="checkbox"/> Dark
<b>Hot Line</b> Would you like to dial a preset number simply by going off-hook?	1 1	desired no. (max. 32 digits)	
	1 2	0	<input type="checkbox"/> <b>Do not use</b>
		1	<input type="checkbox"/> Use
<b>Calling Line Identification Restriction (CLIR)</b> Should you prevent your number being displayed on the called party's telephone?	1 3	0	<input type="checkbox"/> <b>No—Allows your number to be displayed</b>
		1	<input type="checkbox"/> Yes—Prevent your number being displayed

3.1.2 Settings on the Programming Mode

Item	Programming Input	Selection & Parameter	
<b>Calling/Connected Line Identification Presentation (CLIP/COLP)</b> Which number should be displayed on the called and calling party's telephone?	[ 1 ] [ 4 ]	[ 0 ]	<b>Caller ID assigned to your extension</b>
		[ 1 ]	Caller ID assigned on the outside line being used
<b>Preferred Line Assignment—Outgoing</b> Which do you prefer to seize when you go off-hook to make calls?	[ 1 ] [ 9 ]	[ 0 ]	<input type="checkbox"/> No line
		[ 1 ]	<input type="checkbox"/> An idle outside line
		[ 2 ] + The CO line no. assigned to the flexible button or  (CO)	<input type="checkbox"/> A CO/ICD Group button
		[ 3 ] or  /  (PDN)	<input type="checkbox"/> <b>Intercom</b> (On a PDN extension, an idle PDN button is selected when going off-hook.)
<b>Preferred Line Assignment—Incoming</b> Which line do you prefer to answer when you go off-hook?	[ 2 ] [ 0 ]	[ 0 ]	<input type="checkbox"/> No line
		[ 1 ]	<input type="checkbox"/> <b>The longest ringing line (when multiple calls arrive)</b>
		[ 2 ] + The CO line no. assigned to the flexible button or  (CO)	<input type="checkbox"/> A CO/ICD Group button
		[ 3 ] /  (PDN)	<input type="checkbox"/> A PDN button
<b>Alternate Receiving—Ring/Voice**</b> How do you prefer to receive an intercom call?	[ 2 ] [ 1 ]	[ 0 ]	<input type="checkbox"/> <b>Ringing (Tone Call)</b>
		[ 1 ]	<input type="checkbox"/> Directly—The party's voice is heard without ringing.
		[ 2 ]	<input type="checkbox"/> Ring only—Prohibiting the caller switching to the voice mode.

Item	Programming Input	Selection & Parameter	
<b>Paralleled Telephone**13</b> Should the single line telephone in parallel ring?	<input type="checkbox"/> 2 <input type="checkbox"/> 2	<input type="checkbox"/> 0	<input type="checkbox"/> No—The telephone will not ring.
		<input type="checkbox"/> 1	<input type="checkbox"/> <b>Yes—The telephone will ring.</b>
<b>Forced Answerback Selection*1</b> Do you prefer to answer a call without going off-hook regardless of the AUTO ANS button status?	<input type="checkbox"/> 2 <input type="checkbox"/> 3	<input type="checkbox"/> 0	<input type="checkbox"/> <b>No—Disable</b>
		<input type="checkbox"/> 1	<input type="checkbox"/> Yes—Enable
<b>Live Call Screening Mode Set*1</b> Which service do you prefer when a calling party is recording a message in your mailbox?	<input type="checkbox"/> 2 <input type="checkbox"/> 5	<input type="checkbox"/> 0	<input type="checkbox"/> You can monitor the message through the telephone speaker. ( <b>Hands-free mode</b> )
		<input type="checkbox"/> 1	<input type="checkbox"/> Only an alarm tone is heard. (Private mode)
<b>LCS Mode Set (After Answering)</b> Would you like to keep recording after answering the call in the LCS mode?	<input type="checkbox"/> 2 <input type="checkbox"/> 6	<input type="checkbox"/> 0	<input type="checkbox"/> <b>No—Stop recording</b>
		<input type="checkbox"/> 1	<input type="checkbox"/> Yes—Keep recording
<b>Automatic Call Waiting*4</b> Would you prefer to automatically hear a call waiting tone when you receive a call while already on the phone?	<input type="checkbox"/> 3 <input type="checkbox"/> 0	<input type="checkbox"/> 0	<input type="checkbox"/> <b>No—Off</b>
		<input type="checkbox"/> 1	<input type="checkbox"/> Yes—On
<b>Manual Call Waiting</b> How would you prefer to receive call waiting notifications for intercom calls?	<input type="checkbox"/> 3 <input type="checkbox"/> 1	<input type="checkbox"/> 0	<input type="checkbox"/> <b>No call (Off)</b>
		<input type="checkbox"/> 1	<input type="checkbox"/> Tone (BSS)
		<input type="checkbox"/> 2	<input type="checkbox"/> Voice announcement through the built-in speaker (OHCA) <sup>5</sup>
		<input type="checkbox"/> 3	<input type="checkbox"/> Voice announcement through the handset (Whisper OHCA) <sup>6</sup>
<b>Call Waiting Tone Type Selection</b> Which type of call waiting tone do you prefer?	<input type="checkbox"/> 3 <input type="checkbox"/> 2	<input type="checkbox"/> 0	<input type="checkbox"/> <b>Tone 1</b>
		<input type="checkbox"/> 1	<input type="checkbox"/> Tone 2

### 3.1.2 Settings on the Programming Mode

Item	Programming Input	Selection & Parameter	
<b>Absent Message</b> Would you like to show a message on the caller's telephone display?	<input type="text" value="4"/> <input type="text" value="0"/>	<input type="text" value="0"/>	<input type="checkbox"/> <b>No—Off</b>
		message no. (1–8)	<input type="checkbox"/> Yes—Shows the selected message.
		<input type="text" value="9"/>	<input type="checkbox"/> Yes—Shows your personal message.
<b>Personal Absent Message</b> Creating your personal message	<input type="text" value="4"/> <input type="text" value="1"/>	message (max. 16 characters)	
<b>Call Forwarding (FWD)/Do Not Disturb (DND)</b> To forward or refuse some or all of your incoming calls	<input type="text" value="5"/> <input type="text" value="0"/> /  (for both calls)  <input type="text" value="5"/> <input type="text" value="1"/> (for outside calls)  <input type="text" value="5"/> <input type="text" value="2"/> (for intercom calls)	<input type="text" value="0"/>	<input type="checkbox"/> <b>Off</b>
		<input type="text" value="1"/>	<input type="checkbox"/> Do Not Disturb (DND)
		<input type="text" value="2"/> + desired no. (max. 32 digits)	<input type="checkbox"/> All—Forward all calls
		<input type="text" value="3"/> + desired no. (max. 32 digits)	<input type="checkbox"/> Busy—Forwarded when your extension is busy.
		<input type="text" value="4"/> + desired no. (max. 32 digits)	<input type="checkbox"/> No Answer—Forwarded when you do not answer.
		<input type="text" value="5"/> + desired no. (max. 32 digits)	<input type="checkbox"/> Busy/No Answer—Forwarded when you do not answer or when your extension is busy.
<b>FWD N/A Timer</b> To set the timer for "No Answer" and "Busy/No Answer"	<input type="text" value="5"/> <input type="text" value="3"/>	<input type="checkbox"/> (0–120) seconds (Default: 15 seconds)	
<b>Call Pickup Deny</b> Should you prohibit other people from picking up your calls?	<input type="text" value="6"/> <input type="text" value="0"/>	<input type="text" value="0"/>	<input type="checkbox"/> <b>No—Allow</b>
		<input type="text" value="1"/>	<input type="checkbox"/> Yes—Deny
<b>Headset Operation**3</b> Do you use the headset?	<input type="text" value="6"/> <input type="text" value="1"/>	<input type="text" value="0"/>	<input type="checkbox"/> <b>No—Headset off</b>
		<input type="text" value="1"/>	<input type="checkbox"/> Yes—Headset on
<b>Executive Busy Override Deny</b> Do you prohibit other people from joining your conversation?	<input type="text" value="6"/> <input type="text" value="2"/>	<input type="text" value="0"/>	<input type="checkbox"/> <b>No—Allow</b>
		<input type="text" value="1"/>	<input type="checkbox"/> Yes—Deny



Item	Programming Input	Selection & Parameter	
<b>Paging Deny</b> <sup>*1</sup> Would you like to prohibit paging announcements?	<input type="text" value="6"/> <input type="text" value="3"/>	<input type="text" value="0"/>	<input type="checkbox"/> No—Allow
		<input type="text" value="1"/>	<input type="checkbox"/> Yes—Deny
<b>Key Pad Tone Set</b> <sup>*1</sup> Do you prefer to hear the key pad tone?	<input type="text" value="6"/> <input type="text" value="4"/>	<input type="text" value="0"/>	<input type="checkbox"/> No—Off
		<input type="text" value="1"/>	<input type="checkbox"/> Yes—On
<b>Background Music (BGM)</b> <sup>*1</sup> Do you want background music through your telephone speaker while on-hook?	<input type="text" value="6"/> <input type="text" value="5"/>	<input type="text" value="0"/>	<input type="checkbox"/> No—Off
		<input type="text" value="1"/> + BGM no. (1 digit)	<input type="checkbox"/> Yes—On
<b>Bluetooth Registration</b> <sup>*7</sup> To register a Bluetooth wireless headset on your extension <sup>*8</sup>	<input type="text" value="6"/> <input type="text" value="6"/>	Pass key (max. 16 digits)	
<b>Bluetooth Removal</b> <sup>*7</sup> To cancel the registration of a Bluetooth wireless headset on your extension <sup>*8</sup>	<input type="text" value="6"/> <input type="text" value="7"/>	Confirm that the ID of your Bluetooth wireless headset is displayed.	
<b>Extension PIN (Personal Identification Number)</b> To set your extension PIN or change the stored extension PIN	<input type="text" value="9"/> <input type="text" value="0"/>	extension PIN (max. 10 digits) + ENTER/STORE + same extension PIN	To set an extension PIN
		stored extension PIN + new extension PIN (max. 10 digits) + ENTER/STORE + same extension PIN	To change the stored extension PIN
<b>Extension Dial Lock</b> To prevent other people from using your telephone	<input type="text" value="9"/> <input type="text" value="1"/>	<b>extension PIN (max. 10 digits) +</b> <input type="text" value="0"/>	<input type="checkbox"/> To unlock
		extension PIN (max. 10 digits) + <input type="text" value="1"/>	<input type="checkbox"/> To lock
<b>Display Lock</b> <sup>*1</sup> To prevent other people from seeing your personal speed dialling directory, call log, SVM log, and from playing back the voice messages in your message box	<input type="text" value="9"/> <input type="text" value="2"/>	<b>extension PIN (max. 10 digits) +</b> <input type="text" value="0"/>	<input type="checkbox"/> To unlock
		extension PIN (max. 10 digits) + <input type="text" value="1"/>	<input type="checkbox"/> To lock

### 3.1.2 Settings on the Programming Mode

Item	Programming Input	Selection & Parameter	
<b>One-touch Dialling Assignment Mode Selection</b> Do you prefer to set the One-touch dialling only?	<div style="display: flex; justify-content: space-around; align-items: center;"> <span>#</span> <span>*</span> </div>	<div style="border: 1px solid black; border-radius: 50%; width: 30px; height: 30px; display: flex; align-items: center; justify-content: center; margin: 0 auto;">0</div>	<input type="checkbox"/> <b>No—Normal (Any Flexible buttons can be modified.)</b>
		<div style="border: 1px solid black; border-radius: 50%; width: 30px; height: 30px; display: flex; align-items: center; justify-content: center; margin: 0 auto;">1</div>	<input type="checkbox"/> <b>Yes—Only One-touch dialling buttons can be modified. However, to modify them, there is no need to enter "2" before the number.</b>

<sup>\*1</sup> Not available for a PS.

<sup>\*2</sup> Only available for KX-T7633/KX-T7636/IP-PTs (except KX-NT265/KX-NT321/KX-NT511)/KX-DT343/KX-DT346/KX-DT543/KX-DT546 telephones.

<sup>\*3</sup> Not available for the KX-T7665.

<sup>\*4</sup> This setting applies to both outside and intercom calls. For intercom calls, this feature must be enabled through system programming.

<sup>\*5</sup> Only available for certain digital proprietary telephones.

<sup>\*6</sup> Only available for IP-PTs and certain digital proprietary telephones.

<sup>\*7</sup> Only available for KX-NT300 series (except KX-NT321)/KX-NT560/KX-DT343/KX-DT346 telephones.

<sup>\*8</sup> Registering and cancelling a Bluetooth wireless headset may take time. Please avoid any interruption during that time by, for example, going off-hook.



#### CAUTION

There is a risk that fraudulent telephone calls will be made if a third party discovers your password (extension PIN).

The cost of such calls will be billed to the owner/renter of the PBX.

To protect the PBX from this kind of fraudulent use, we strongly recommend:

- a.** Keeping your PIN secret.
- b.** Selecting a complex, random PIN that cannot be easily guessed.
- c.** Changing your PIN regularly.
- After the programme number is entered, the programme title is displayed. The programming screen can be changed with the Navigator Key (Up or Down).
- You can select the parameter with the Navigator Key (Up or Down) instead of entering a number.



To store the names and numbers in personal speed dialling

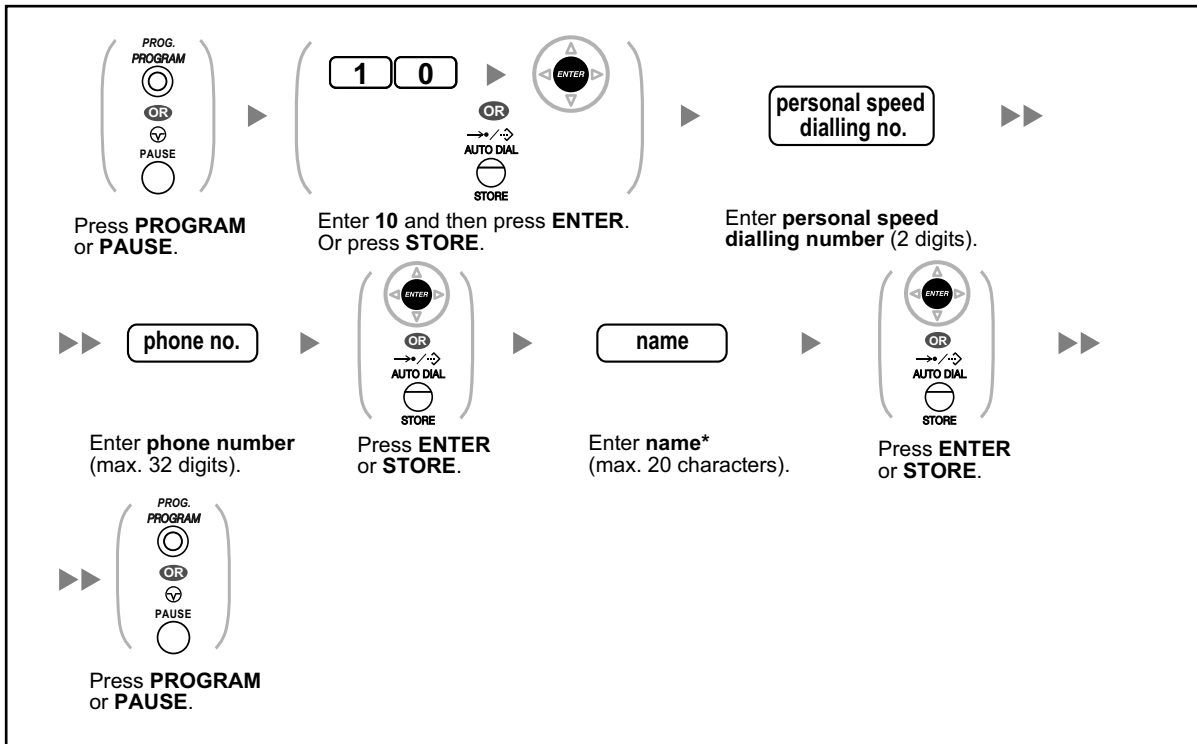

- \* To enter characters, refer to "◆◆ Entering Characters".

### 3.1.2 Settings on the Programming Mode

#### To edit the names and numbers of personal speed dialling

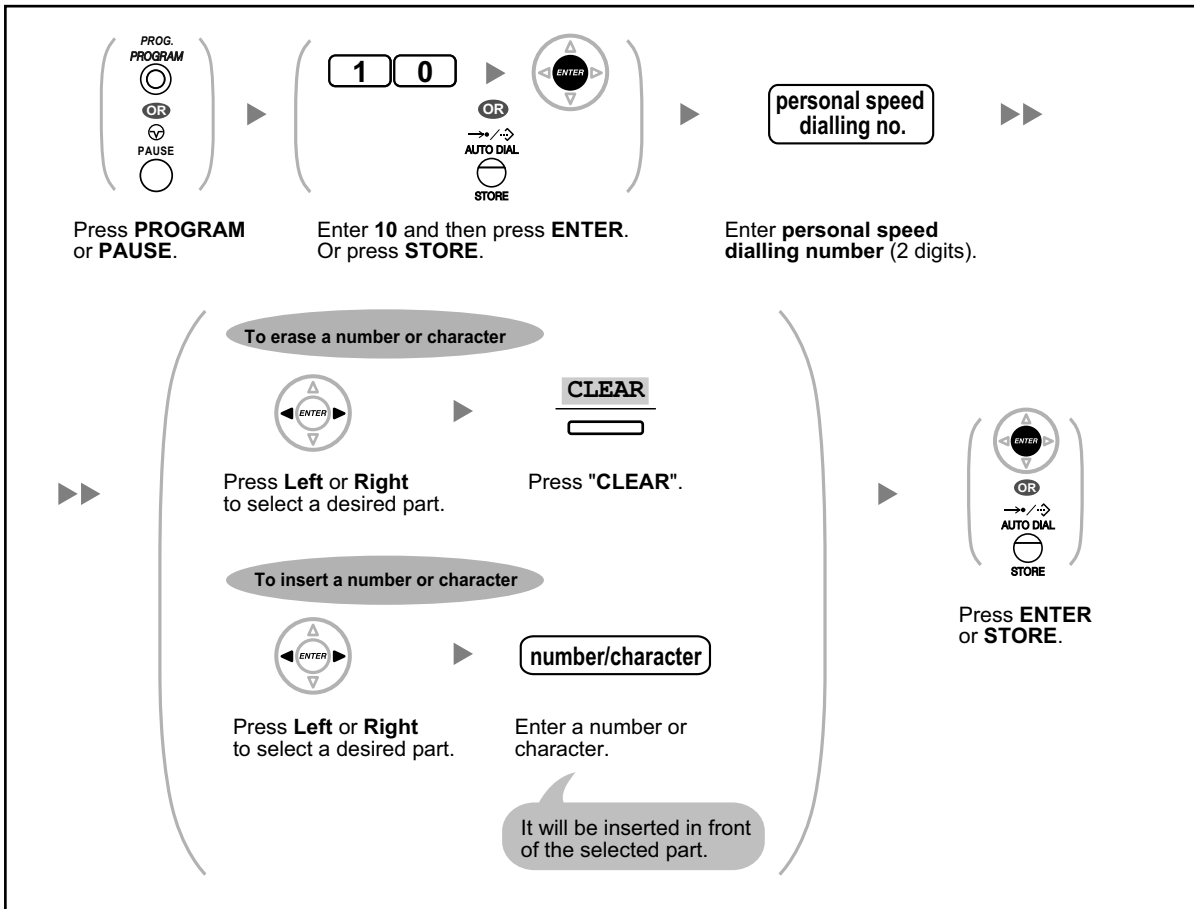

### ◆◆ Clearing Features

You can clear or change to features as follows:

Features	Default Setting
Display Switching Mode	<b>Automatic</b>
Hot Line	<b>Off</b>
Calling Line Identification Restriction (CLIR)	<b>Allow</b>
Calling/Connected Line Identification Presentation (CLIP/COLP)	<b>Caller ID assigned on your extension</b>
Preferred Line Assignment—Outgoing	<b>Intercom</b>
Preferred Line Assignment—Incoming	<b>The longest ringing line</b>
Alternate Receiving—Ring/Voice	<b>Ringing (Tone Call)</b>
Paralleled Telephone	<b>Paired SLT will ring</b>
Forced Answerback Selection	<b>Disable</b>
Live Call Screening Mode Set	<b>Hands-free mode</b>

Features	Default Setting
LCS Mode Set (After Answering)	Stop recording
Automatic Call Waiting	Off
Manual Call Waiting—Intercom Calls	Off (No call/No tone)
Call Waiting Tone Type Selection	Tone 1
Absent Message	Off
Personal Absent Message	Cleared
Call Forwarding (FWD)/Do Not Disturb (DND)—Intercom/Outside Calls	Off
FWD N/A Timer	15 seconds
Call Pickup Deny	Allow
Headset Operation	Headset off
Executive Busy Override Deny	Allow
Paging Deny	Allow
Key Pad Tone Set	On
Background Music (BGM)	Off
Data Line Security	Off
Connected Line Identification Restriction [COLR]	Allow
Log-in/Log-out	Log-in
Message Waiting	Off
Timed Reminder	Cleared

**To change the above features back to their default settings**

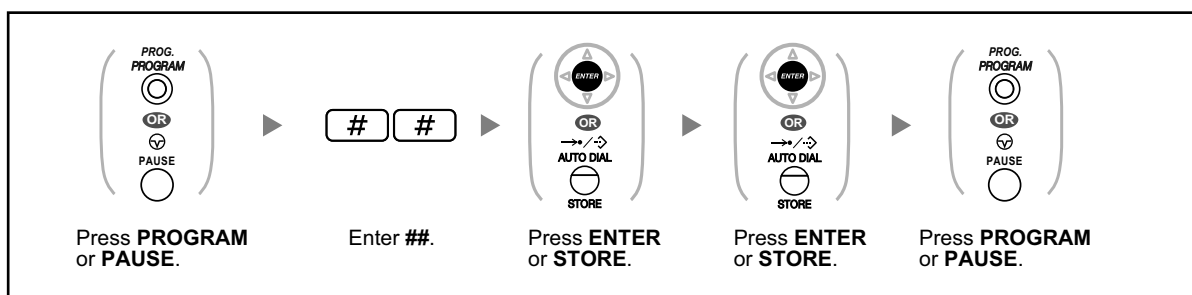

- If you do not desire that the Call Waiting, FWD/DND or Hot Line to be cleared by this feature, please ask your dealer.

### 3.1.3 Customising the Buttons

You can customise the flexible buttons and/or programmable feature (PF) buttons on PTs, Add-on Key Modules, and PSs. They can then be used to make or receive outside calls or as feature buttons.



- To enter programming mode when using a PS, refer to the documentation for your PS.
- The buttons in the table below can only be set on certain flexible buttons, as follows:
  - Flexible buttons on PTs/Add-on Key Modules/PSs: all buttons can be set.
  - Flexible buttons on DSS Consoles: all buttons except CTI and Primary Directory Number (PDN) buttons can be set.
  - Programmable feature (PF) buttons: only the One-touch Dialling button can be set.
- For KX-UT series SIP phone users and S-PS users: You cannot customise the flexible buttons with the following method from your phone. You can customise the flexible buttons using Web Maintenance Console. For details, refer to "Customising the Flexible Buttons".
- For KX-NT511 users:**  
Since there is no PROGRAM button on a KX-NT511, press and hold flexible button 1, 2, or 3 instead.

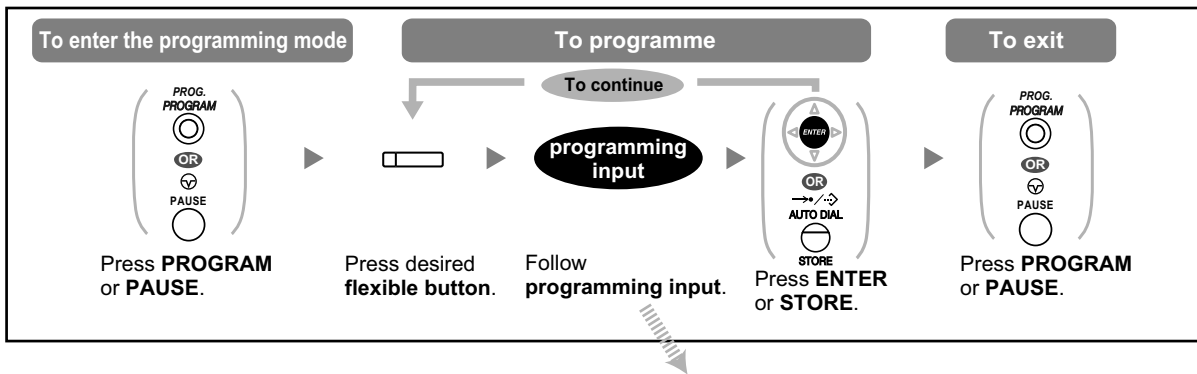

Button	Programming Input
Loop-CO (L-CO)	[*]
Group-CO (G-CO)	[#] + Outside line group no. (2 digits)
Single-CO (S-CO)	[0] + Outside line no. (3 digits)
Direct Station Selection (DSS)	[1] + Extension no. <sup>12</sup>
One-touch Dialling <sup>1</sup>	[2] <sup>2</sup> + Desired no. (max. 32 digits)
Incoming Call Distribution Group (ICD Group)	[3] [0] + Incoming call distribution group extension no. (+ [#] + delayed ringing time [0-7]) <sup>3</sup>
Message	[4] [0]
Message for Another Extension	[4] [0] + Extension no./Incoming call distribution group extension no.
Call Forwarding (FWD)/Do Not Disturb (DND)—Both calls	[4] [1]

Button	Programming Input
FWD/DND—Outside calls	<input type="text" value="4"/> <input type="text" value="2"/>
FWD/DND—Intercom calls	<input type="text" value="4"/> <input type="text" value="3"/>
Group FWD—Both calls	<input type="text" value="4"/> <input type="text" value="4"/> + Incoming call distribution group extension no.
Group FWD—Outside calls	<input type="text" value="4"/> <input type="text" value="5"/> + Incoming call distribution group extension no.
Group FWD—Intercom calls	<input type="text" value="4"/> <input type="text" value="6"/> + Incoming call distribution group extension no.
Account	<input type="text" value="4"/> <input type="text" value="8"/>
Conference	<input type="text" value="4"/> <input type="text" value="9"/>
Terminate	<input type="text" value="5"/> <input type="text" value="0"/>
External Feature Access (EFA)	<input type="text" value="5"/> <input type="text" value="1"/>
Call Charge Reference	<input type="text" value="5"/> <input type="text" value="2"/>
Call Park	<input type="text" value="5"/> <input type="text" value="3"/> + Parking zone no. (2 digits)
Call Park (Automatic Park Zone)	<input type="text" value="5"/> <input type="text" value="3"/> <input type="text" value="✳"/>
Call Log <sup>4</sup>	<input type="text" value="5"/> <input type="text" value="4"/>
Call Log for ICD Group <sup>4</sup>	<input type="text" value="5"/> <input type="text" value="4"/> + Incoming call distribution group extension no.
Log-in/Log-out	<input type="text" value="5"/> <input type="text" value="5"/>
Log-in/Log-out of a specified group	<input type="text" value="5"/> <input type="text" value="5"/> + Incoming call distribution group extension no.
Log-in/Log-out for all groups	<input type="text" value="5"/> <input type="text" value="5"/> <input type="text" value="✳"/>
Hurry-up	<input type="text" value="5"/> <input type="text" value="6"/> + Incoming call distribution group extension no.
Wrap-up	<input type="text" value="5"/> <input type="text" value="7"/>
System Alarm <sup>4</sup>	<input type="text" value="5"/> <input type="text" value="8"/>
Time Service (Day/Night/Lunch/Break)	<input type="text" value="5"/> <input type="text" value="9"/> + 0/1/2/3 <sup>5</sup> (+ <input type="text" value="#"/> + Tenant no.)
Answer <sup>4</sup>	<input type="text" value="6"/> <input type="text" value="0"/>
Release <sup>4</sup>	<input type="text" value="6"/> <input type="text" value="1"/>
Toll Restriction/Call Barring	<input type="text" value="6"/> <input type="text" value="2"/> + Toll Restriction/Call Barring Level (1–7)
ISDN Service <sup>6</sup>	<input type="text" value="6"/> <input type="text" value="3"/> + Desired no. (max. 32 digits)

### 3.1.3 Customising the Buttons

Button	Programming Input
Calling Line Identification Restriction (CLIR)	<input type="text" value="6"/> <input type="text" value="4"/>
Connected Line Identification Restriction (COLR)	<input type="text" value="6"/> <input type="text" value="5"/>
ISDN-Hold	<input type="text" value="6"/> <input type="text" value="6"/>
Headset <sup>*4*7</sup>	<input type="text" value="6"/> <input type="text" value="7"/>
Time Service Switching Mode (Automatic/Manual)	<input type="text" value="6"/> <input type="text" value="8"/> (+ Tenant no.)
Network Direct Station Selection (NDSS) <sup>*8</sup>	<input type="text" value="6"/> <input type="text" value="9"/> + Another PBX extension no.
CTI	<input type="text" value="7"/> <input type="text" value="0"/>
Primary Directory Number (PDN)	<input type="text" value="7"/> <input type="text" value="1"/>
Secondary Directory Number (SDN)	<input type="text" value="7"/> <input type="text" value="2"/> + Extension no. + <input type="text" value="#"/> + delayed ringing time (0–7) <sup>*9</sup>
Check-in <sup>*4</sup>	<input type="text" value="8"/> <input type="text" value="0"/>
Check-out <sup>*4</sup>	<input type="text" value="8"/> <input type="text" value="1"/>
Cleaned-up <sup>*4</sup>	<input type="text" value="8"/> <input type="text" value="2"/>
Two-way Record <sup>*10</sup>	<input type="text" value="9"/> <input type="text" value="0"/> + UM group's floating extension no. <sup>**11</sup> /Voice mail floating extension no.
Two-way Transfer <sup>*10</sup>	<input type="text" value="9"/> <input type="text" value="1"/> + UM group's floating extension no. <sup>**11</sup> /Voice mail floating extension no.
One-touch Two-way Transfer <sup>*10</sup>	<input type="text" value="9"/> <input type="text" value="1"/> + UM group's floating extension no. <sup>**11</sup> /Voice mail floating extension no. + # + Extension no./Incoming call distribution group extension no.
Live Call Screening (LCS) <sup>*10</sup>	<input type="text" value="9"/> <input type="text" value="2"/>
Voice Mail Transfer <sup>*10</sup>	<input type="text" value="9"/> <input type="text" value="4"/> + UM group's floating extension no. <sup>**11</sup> /Voice mail floating extension no.





- \*1 "×", "#", FLASH/RECALL, PAUSE, Secret (INTERCOM) and TRANSFER can also be stored.  
If you do not want to display the stored number when making a call, press the Secret (INTERCOM) button before and after the numbers you wish to conceal.  
If you store an outside party's number, you should first store a line access number.  
If you need to enter an account code, you can enter the specified account code before the line access number.  
<Example>

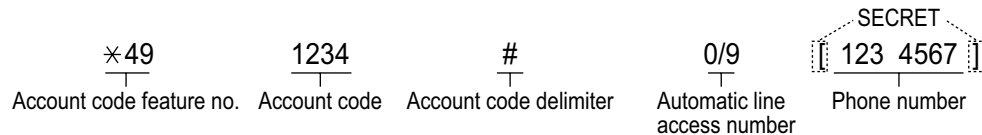

- \*2 For a PF button, "2" is not required to enter before the desired number.
- \*3 Depending on the settings of your PBX, you may be required to enter delayed ringing time (0: Immediate, 1: 1 ring, 2: 2 rings, 3: 3 rings, 4: 4 rings, 5: 5 rings, 6: 6 rings, 7: No ring). In this case, you can automatically join a new ICD Group by creating a button for that group.
- \*4 This button is not available for a PS.
- \*5 0: Day/Night/Lunch/Break, 1: Day/Night/Break, 2: Day/Night/Lunch, 3: Day/Night
- \*6 Availability of this button depends on the ISDN service of your telephone company. Refer to "1.2.5 Accessing the ISDN Service (ISDN Service Access)".
- \*7 This button is not available for the KX-T7665.
- \*8 The button may not be available depending on the networking method in use or the settings of the PBX.
- \*9 It is possible to set delayed ringing for each SDN button.
- \*10 This button is used for the integrated voice mail features.
- \*11 The UM group's default floating extension number is 500.
- **To exit at any time**, lift the handset.
- For KX-NT366 and KX-NT553/KX-NT556/KX-NT560 users: After customising a flexible button, you can set the displayed text for Self Labelling. To enter characters, refer to "◆◆ Entering Characters".
- \*12 You can set a Unified Messaging port extension number as an extension number for the DSS button.



- You can select the parameter with the Navigator Key (Up or Down) instead of entering a number.

### 3.1.3 Customising the Buttons

To specify the ringing tones for each CO, ICD Group, PDN, SDN, or INTERCOM button (DPT/ IP-PT only)

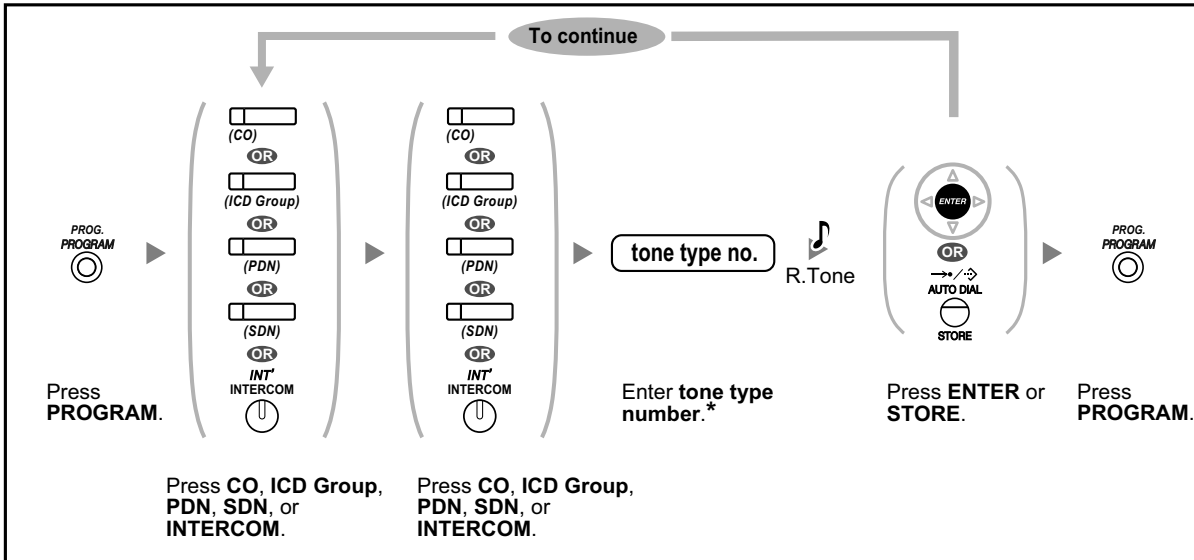

- \* Available tone types vary depending on the telephone you are using:
  - KX-NT300 series (except KX-NT321)/KX-NT500 series/KX-DT300 series (except KX-DT321)/KX-DT500 series (except KX-DT521)/KX-T7600 series (except KX-T7665): Tone types "01" to "30" (01–20: tone, 21–30: melody) are available.
  - KX-NT265/KX-NT321/KX-DT321/KX-T7665: Only tone types "01" to "08" are available. It is possible to enter a tone type number from "09" to "30", but you will hear tone type "01".
  - Other telephones: Only tone types "01" to "08" are available. It is possible to enter a tone type number from "09" to "30", but you will hear tone type "02".
- Only one ringing tone can be selected for all PDN buttons on your extension.

### To clear the button

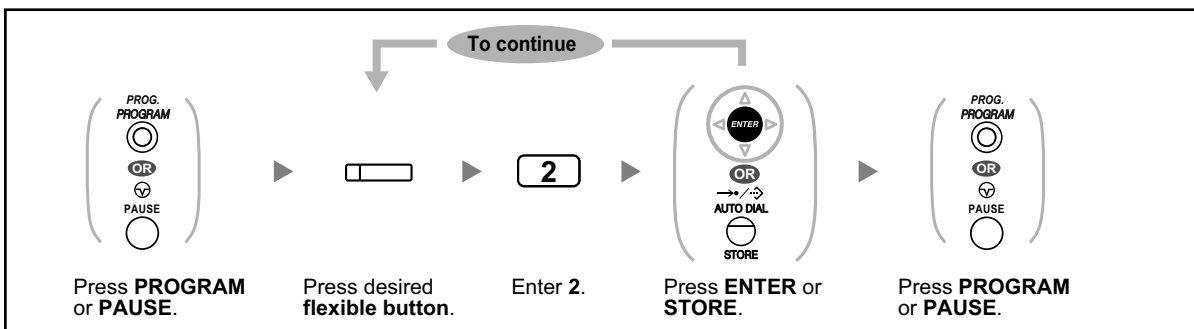

## 3.2 System Programming Using Web Maintenance Console

### 3.2.1 User Programming

You can edit your personal information as well as limited extension and mailbox settings using Web Maintenance Console. (You can view menus and setting items, but you can edit only a limited number of items.) In addition, you can download the UM IMAP Session Controller for Microsoft Outlook. For details, refer to "◆◆ IMAP" in "1.8.6 Other Features".

- ◆◆ Accessing Web Maintenance Console for the First Time
- ◆◆ Logging in to Web Maintenance Console
- ◆◆ Edit User Screen
- ◆◆ Editing Settings in Web Maintenance Console
- ◆◆ Automatic Two-way Recording for Manager
- ◆◆ Logout



- The contents and design of the software are subject to change without notice.

#### ◆◆ Accessing Web Maintenance Console for the First Time

This step is required only when accessing Web Maintenance Console for the first time.



- For the IP address of the PBX, login name, and password, ask your System Administrator.
- If the configuration of the Web browser or PC changes, the certificate may need to be installed again. Once a certificate has been installed, Web Maintenance Console will be displayed after step 2.

1. Launch your Web browser and input the IP address of the PBX followed by the Web Maintenance Console port number into the address bar, and then press **Enter**.
2. If you connect to Web Maintenance Console using SSL, a security alert window is displayed. Follow the prompts to install a security certificate. The procedure may vary according to your browser.

#### ◆◆ Logging in to Web Maintenance Console

After establishing a connection to Web Maintenance Console, the login window is displayed, and a login name and password must be entered.

### 3.2.1 User Programming



- If you attempt to log in, but enter an incorrect password three times, you may not attempt to log in again for a 5 minute period.

#### **CAUTION**

- For security, change the password the first time that you programme the PBX.
- It is strongly recommended that a password of 16 numbers or characters be used for maximum protection against unauthorised access.
- To avoid unauthorised access to the PBX, keep the password secret. If it becomes known to others, the PBX may be misused.
- Change the password periodically.

### ◆◆ Edit User Screen

The **Edit User** screen is displayed when you login to Web Maintenance Console. On this screen, you can edit various user settings.

To finish editing, click **OK**.

### ◆◆ Editing Settings in Web Maintenance Console

#### Changing Your User Name and Displayed Language

You can change your account's first name, last name, and displayed language in the **User Information** tab of the **Edit User** screen. The information entered in **First Name** and **Last Name** are displayed on your telephone.

1. In the **User Information** tab, edit your **First Name** (max. 20 characters) and **Last Name** (max. 20 characters), and select the displayed language from the **Change Language** drop-down list.

2. Click **OK**.

#### Changing Your Contact Information

You can change your extension PIN and contact information (home number, mobile number, fax number, and e-mail address) in the **Contact** tab of the **Edit User** screen. E-mail address(es) specified in **Email 1–3** in the **Contact** tab are used for e-mail notifications of missed outside calls (refer to "Changing E-mail Notification Settings" in "3.2.1 User Programming").

1. In the **Contact** tab, edit **Extension PIN** (max. 10 digits), **Fax**, **Phone (Home)**, **Phone (Mobile)**, and **Email 1–3**.

#### Note

Entry for the extension PIN is hidden and displayed as dots ".".

2. Click **OK**.

## Changing Your Mailbox Password

You can change your mailbox password in the **Unified Message** tab of the **Edit User** screen.

1. In the **Unified Message** tab, click **Edit** for **Mailbox Password**.  
To change your message client password, click **Edit** for **Mailbox Password (Message Client)**.

2. Enter a password in **Enter new password**, and then re-enter it in **Confirm new password**.

#### Note

Entry for the password is hidden and displayed as dots ".".

3. Click **OK**.

## Registering a Prompt to the Mailbox

You can display, play, record or delete the following prompts:

- Mailbox Owner Name (refer to "◆◆ Changing or Deleting Your Subscriber (Owner) Name")
  - Personal Greetings (refer to "◆◆ Changing or Deleting Your Personal Greeting Messages")
    - No Answer Greeting, Busy Signal Greeting, After Hours Greeting, Caller ID Greeting<sup>1</sup>, Temporary Greeting and Absent Message
  - Interview Mailbox Questions<sup>2</sup> (refer to "◆◆ Interview Mailbox")
  - Personal Caller ID Name<sup>1</sup> (refer to "◆◆ Personal Caller Name Announcement")
  - Personal Distribution List Voice Label<sup>2</sup> (refer to "◆◆ Personal Group Distribution Lists")
- <sup>1</sup> This feature may be disabled depending on your COS settings.  
<sup>2</sup> This feature may be disabled depending on your system programming settings or mailbox settings.

1. In the **Unified Message** tab, click **Prompt Registration**.

2. In the **Prompt Registration** box, select a tab for the desired type of prompt.

### 3.2.1 User Programming

---

#### To record a prompt

Select a **Prompt No.**, and click **Play/Record**.

**When "Record from extension" is selected:**

- a. Specify the extension number of the telephone used for recording, then click **Connect**.
- b. When the specified extension rings, go off-hook.
- c. Click **Record**, **Stop**, or **Play** to record or play a system prompt.
- d. Click **Disconnect**.

**When "Import from recorded file" is selected:**

- a. Click **Browse**. The Open dialogue box appears.
- b. Navigate to the folder containing the WAV files you wish to import.
- c. Select the desired WAV file.
- d. Click **Open** to import the file.
- e. Click **OK**.

#### To start and stop prompt playback

- a. Select the desired prompt.
- b. Click **Play/Record**.
- c. Click **Play** or **Stop**.

#### To delete a specific prompt

- a. Select the desired prompt.
- b. Click **Delete**.
- c. Click **OK**.

### Customising your mailbox setting

You can change your mailbox setting in the **Unified Message** tab of the **Edit User** screen.

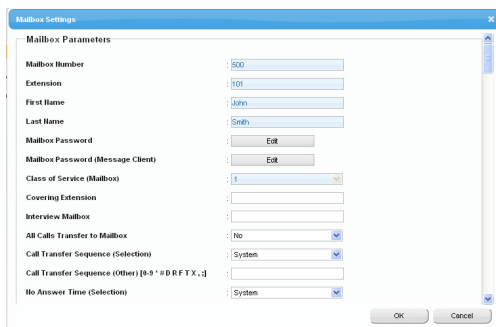

1. In the **Unified Message** tab, click **Advanced setting**.
2. The **Mailbox Settings** box appears. The following items are editable.

## Mailbox Parameters

Item	Description
<b>Mailbox Password</b>	<p>Specifies the password needed to access the mailbox. If a default password is programmed by an administrator, that password will be assigned automatically when creating all mailboxes.</p> <p>To change a password for a mailbox:</p> <ol style="list-style-type: none"> <li>1. Click <b>Edit</b>.</li> <li>2. In the window that appears, enter the new password (4–16 characters in length) and then enter it again to confirm it.</li> <li>3. Click <b>OK</b>.</li> </ol>
<b>Mailbox Password (Message Client)</b>	<p>Specifies the password needed to access the mailbox when using a client software program. If a default password is programmed by an administrator, that password will be assigned automatically when creating all mailboxes.</p> <p>To change a password for a mailbox:</p> <ol style="list-style-type: none"> <li>1. Click <b>Edit</b>.</li> <li>2. In the window that appears, enter the new password (4–16 characters in length) and then enter it again to confirm it.</li> <li>3. Click <b>OK</b>.</li> </ol>
<b>Covering Extension</b>	<p>Enter a desired extension number you want to assign for transferring to your Covering Extension in the box (1–8 digits).</p>
<b>Interview Mailbox</b>	<p>Enter an interview mailbox number you want to assign for your mailbox in the box (2–8 digits [the maximum number of digits may be less than 8, depending on system programming]).</p>
<b>All Calls Transfer to Mailbox</b>	<p>Select <b>Yes</b> or <b>No</b>.</p> <p>If <b>Yes</b> is selected, calls are automatically forwarded to your mailbox.</p>
<b>Call Transfer Sequence (Selection), Call Transfer Sequence (Other)</b>	<p>Specifies the Call Transfer Sequence used by the mailbox. Allows each mailbox to be assigned its own Call Transfer Sequence (Personal Transfer Sequence).</p> <ol style="list-style-type: none"> <li>1. Select <b>System</b> or <b>Other</b>.</li> <li>2. If "Other" is specified, enter a maximum of 16 characters consisting of 0–9, *, # and special codes: <ul style="list-style-type: none"> <li>• <b>D</b>: Disconnecting</li> <li>• <b>F</b>: Flash (Recall)</li> <li>• <b>R</b>: Ringback Tone Detection</li> <li>• <b>T</b>: Dial Tone Detection</li> <li>• <b>,</b>: Dial Pause (default 1 s)</li> <li>• <b>;</b>: Dial Pause (default 3 s)</li> <li>• <b>X</b>: Extension Dialling</li> <li>• <b>0–9, *, #</b>: Dial Code</li> </ul> </li> </ol>
<b>No Answer Time (Selection), No Answer Time (Other)</b>	<p>Specifies the length of time that the Unified Messaging system waits before handling unanswered calls to the extension.</p> <ol style="list-style-type: none"> <li>1. Select <b>System</b> or <b>Other</b>.</li> <li>2. If "Other" is selected, specify 10–60 s.</li> </ol>

### 3.2.1 User Programming

---

Item	Description
<b>Call Transfer Status</b>	<p>Determines how the Unified Messaging system handles a call when it reaches your extension.</p> <ol style="list-style-type: none"><li>1. Click <b>Edit</b>.</li><li>2. Select the setting from the following items.<ul style="list-style-type: none"><li>• <b>None</b>: Rings your extension.</li><li>• <b>Call blocking</b>: Handles the call according to the Incomplete Call Handling for No Answer setting for your extension. Your extension will not ring.</li><li>• <b>Call screening</b>: The caller is prompted to record his or her name. The Unified Messaging system then calls you and plays back the caller name. You can choose whether to answer the call.</li><li>• <b>Intercom Paging</b>: Pages you by intercom.</li><li>• <b>Transfer to Mailbox</b>: Transfers the caller to the mailbox.</li><li>• <b>Transfer to specified Custom Service Menu</b>: Transfers the caller to the specified Custom Service.</li><li>• <b>Transfer to specified telephone number 1–5</b>: Transfers the caller to one of the specified telephone numbers in numerical order of priority.</li></ul></li><li>3. Click <b>OK</b> to finish.</li></ol>
<b>Incomplete Call Handling for No Answer</b>	<p>Specifies how the Unified Messaging system handles a call when there is no answer.</p> <ol style="list-style-type: none"><li>1. Click <b>Edit</b>.</li><li>2. Select the setting from the following items. More than one option can be selected.<ul style="list-style-type: none"><li>• <b>Leave a Message</b>: Allows the caller to record a message.</li><li>• <b>Transfer to a covering extension</b>: Transfers the caller to a covering extension.</li><li>• <b>Page the mailbox owner by intercom paging</b>: Pages you by intercom.</li><li>• <b>Transfer to operator</b>: Transfers the caller to an operator.</li><li>• <b>Return to top menu</b>: Lets the caller return to top menu and try another extension.</li><li>• <b>Transfer to specified Custom Service Menu</b>: Transfers the caller to the specified Custom Service.</li></ul></li><li>3. Click <b>OK</b> to finish.</li></ol>



Item	Description
<b>Incomplete Call Handling for Busy</b>	<p>Specifies how the Unified Messaging system handles a call when the extension is busy.</p> <ol style="list-style-type: none"> <li>1. Click <b>Edit</b>.</li> <li>2. Select the setting from the following items. More than one option can be selected. <ul style="list-style-type: none"> <li>• <b>Leave a Message</b>: Allows the caller to record a message.</li> <li>• <b>Transfer to a covering extension</b>: Transfers the caller to a covering extension.</li> <li>• <b>Page the mailbox owner by intercom paging</b>: Pages you by intercom.</li> <li>• <b>Transfer to operator</b>: Transfers the caller to an operator.</li> <li>• <b>Return to top menu</b>: Lets the caller return to top menu and try another extension.</li> <li>• <b>Transfer to specified Custom Service Menu</b>: Transfers the caller to the specified Custom Service.</li> </ul> </li> <li>3. Click <b>OK</b> to finish.</li> </ol>
<b>Call Transfer Anytime in Incomplete Handling Menu</b>	<p>Specifies whether callers can input an extension number to transfer their call while the Automated Attendant service is playing an Incomplete Call Handling menu.</p>

#### Advanced Call Transfer Setting

Item	Description
<b>Advanced Call Transfer Setting</b>	<p>By combining the settings for Call Transfer and Incomplete Call Handling, you can create call handling "scenarios" for your extension. Up to 20 scenarios can be created, and a scenario can be assigned to each absent message in <b>Scenario Setting</b>.</p> <ol style="list-style-type: none"> <li>1. Click <b>Edit</b> for creating scenarios.</li> <li>2. Select a Scenario number (1–20) from the drop-down list.</li> <li>3. Type the scenario name in the <b>Scenario Name</b> box.</li> <li>4. Assign the following options in each section. Click <b>OK</b> when finished.</li> </ol> <p><b>Call Transfer Status</b></p> <p>Determines how the Unified Messaging system will handle a call in the selected scenario.</p>

Item	Description
	<p><b>Selection</b>            Determines how the Unified Messaging system will handle a call in the selected scenario.            Select the setting from the following items.</p> <ul style="list-style-type: none"> <li>• <b>None:</b> Rings your extension.</li> <li>• <b>Call blocking:</b> Handles the call according to the Incomplete Call Handling for No Answer setting for your extension. Your extension will not ring.</li> <li>• <b>Call screening:</b> The caller is prompted to record his or her name. The Unified Messaging system then calls you and plays back the caller name. You can choose whether to answer the call.</li> <li>• <b>Leave a Message:</b> Transfers the caller to the mailbox.</li> <li>• <b>Intercom Paging:</b> Pages you by intercom.</li> <li>• <b>Transfer to specified Custom Service Menu:</b> Transfers the caller to the specified Custom Service.</li> </ul> <p><b>VIP Filter</b>            If "Leave a Message" is selected for <b>Selection</b> and "Enable" is selected for this setting, calls from certain phone numbers will be transferred directly to your extension or specified telephone number.</p> <ul style="list-style-type: none"> <li>• <b>Telephone Number 1, 2, 3:</b> Specifies the telephone numbers that the <b>VIP Filter</b> setting will be applied to. When a call is received from any of the numbers specified here, the call will be transferred immediately to the destination specified in <b>Transfer to (Selection)</b>.</li> <li>• <b>Transfer to (Selection):</b> Specifies the transfer destination for calls transferred according to the <b>VIP Filter</b> setting.               <ul style="list-style-type: none"> <li>– <b>Extension:</b> The call is transferred to your extension.</li> <li>– <b>Other:</b> The call is transferred to the telephone number that is specified in <b>Transfer to (Other)</b>.</li> </ul> </li> </ul> <p><b>Transfer to specified Custom Service Menu</b>            Select a Custom Service from the drop-down menu if "Transfer to specified Custom Service Menu" is selected for <b>Selection</b>.</p> <p><b>Transfer to specified telephone number - 1</b>            If "None" or "Call screening" is selected for <b>Selection</b>, specifying a telephone number here will transfer the caller to that telephone number. Enter a maximum of 32 characters consisting of 0–9, *, and #.</p> <p><b>Note</b>            If "Call screening" is selected, the transfer destination will hear the call screening prompt before the call is transferred.</p>

Item	Description
	<p><b>Transfer to specified telephone number 2, 3, 4, 5 (Selection/Other)</b> If "None" or "Call screening" is selected for <b>Selection</b>, and the call could not be transferred to the number specified in <b>Transfer to specified telephone number - 1</b>, the call will be transferred according to these settings for this scenario, in numerical order of priority.</p> <p><b>Note</b> If "Call screening" is selected, the transfer destination will hear the call screening prompt before the call is transferred.</p> <ol style="list-style-type: none"> <li>1. Select <b>Other</b>, <b>Extension</b>, or <b>Covering Extension</b>.</li> <li>2. If "Other" is specified, enter a maximum of 32 characters consisting of 0–9, *, and #.</li> </ol> <p><b>Incomplete Call Handling for No Answer</b> Specifies how the scenario handles a call when there is no answer. More than one option can be selected.</p> <ul style="list-style-type: none"> <li>• <b>Leave a Message:</b> Allows the caller to record a message.</li> <li>• <b>Transfer to a covering extension:</b> Transfers the caller to a covering extension.</li> <li>• <b>Page the mailbox owner by intercom paging:</b> Pages you by intercom.</li> <li>• <b>Transfer to operator:</b> Transfers the caller to an operator.</li> <li>• <b>Return to top menu:</b> Lets the caller return to top menu and try another extension.</li> <li>• <b>Transfer to specified Custom Service Menu:</b> Transfers the caller to the specified Custom Service.</li> </ul> <p><b>Incomplete Call Handling for Busy</b> Specifies how the scenario handles a call when the destination is busy. More than one option can be selected.</p> <ul style="list-style-type: none"> <li>• <b>Leave a Message:</b> Allows the caller to record a message.</li> <li>• <b>Transfer to a covering extension:</b> Transfers the caller to a covering extension.</li> <li>• <b>Page the mailbox owner by intercom paging:</b> Pages you by intercom.</li> <li>• <b>Transfer to operator:</b> Transfers the caller to an operator.</li> <li>• <b>Return to top menu:</b> Lets the caller return to top menu and try another extension.</li> <li>• <b>Transfer to specified Custom Service Menu:</b> Transfers the caller to the specified Custom Service.</li> </ul>
<b>Scenario Setting</b>	<p>You can select scenarios set in <b>Advanced Call Transfer Setting</b>. A scenario can be set temporarily, or scenarios can be selected for use according to the Absent Message setting of your extension.</p> <ul style="list-style-type: none"> <li>• <b>Current Scenario:</b> The scenario that is assigned to the absent message currently set at your extension is displayed here.</li> <li>• <b>Temporary Scenario:</b> Setting a scenario here will use that scenario indefinitely. A scenario set here will be used regardless of your extension status. Selecting "None" will remove the setting.</li> <li>• <b>Absent Message 1–9:</b> The selected scenario will be used when the corresponding Absent Message is set at your extension.</li> </ul>

**Notification Parameters**

Item	Description
<b>Message Waiting Lamp</b>	If set to "Enable", the Message Waiting Lamp of your telephone turns on when a new message is recorded.
<b>Telephone Device—Device No. 1, 2, 3</b>	<p>Specifies the Message Waiting Notification schedule for each device. The following parameters can be specified for devices 1, 2, and 3. Click <b>Edit</b> for the extension to change, set <b>Device Notification for Unreceived Message</b> to "Yes", and set program the settings, then click <b>OK</b> to finish.</p> <p><b>Only Urgent Messages</b> Specifies if notifications will be sent only for messages designated as urgent.</p> <p><b>Dial Number [0-9 * # T X , ;]</b> Assigns a telephone number to Device 1, 2, or 3. You can also specify the number to be dialed by entering it from your telephone, allowing you to set this feature on a case by case basis. Enter a maximum of 32 digits consisting of 0–9, *, # and special codes:</p> <ul style="list-style-type: none"> <li>• ,: Dial Pause (default 1 s)</li> <li>• ;: Dial Pause (default 3 s)</li> <li>• T: Dial Tone Detection</li> <li>• X: Callback Number Entry Code</li> <li>• 0–9, *, #: Dial Code</li> </ul> <p><b>Note</b> If you are using a PRI line, you may need to enter # at the end of outside telephone numbers.</p> <p><b>No. of Retries</b> Specifies the number of times the Unified Messaging system will try to send notification if the device is busy or if there is no answer.</p> <p><b>Busy Delay Time (min)</b> Specifies the time (in minutes) the Unified Messaging system waits before retrying message notification when the called device is busy.</p> <p><b>No Answer Delay Time (min)</b> Specifies the time (in minutes) the Unified Messaging system waits before retrying message notification when the called device does not answer.</p>

Item	Description
	<p><b>Use Mode</b></p> <p>Specifies if and how each device is used for message notification. You can also specify the use mode from your telephone:</p> <ul style="list-style-type: none"> <li>• <b>Not use:</b> The selected device is not used for message notification.</li> <li>• <b>Continuously:</b> The device is called whenever a message is recorded in the mailbox. If <b>Only Urgent Messages</b> is set to "Yes", the device is called whenever an urgent message is recorded in the mailbox.</li> <li>• <b>Scheduled:</b> The selected device is called only during the selected times.</li> </ul> <p><b>Time Frame:</b> If <b>Scheduled</b> is selected here, follow the steps below to specify the time frame:</p> <ol style="list-style-type: none"> <li>1. Click a day (<b>Sunday – Saturday</b>) tab.</li> <li>2. Click <b>Enable Time Frame No. 1</b> or <b>2</b>.</li> <li>3. Enter the start and end times in the "Start At (HH:MM)" and "End At (HH:MM)" fields.</li> <li>4. Repeat steps <b>1</b> to <b>3</b> for each day to be programmed, and then Click <b>OK</b>.</li> </ol>
<p><b>Telephone Device—Device Notification Timer—Device Start Delay Time (0-120 min)</b></p>	<p>Specifies the length of time the system waits after a new message is received before sending message waiting notification.</p>
<p><b>Telephone Device—Device Notification Timer—Device Interval Time between Device 1, 2, 3 and Next Device</b></p>	<p>Specifies how long the PBX waits after sending Message Waiting Notification to Device 1, 2, or 3 before sending notification to the next device.</p>
<p><b>E-mail/Text Message Device—Device No. 1, 2, 3</b></p>	<p>You can be notified by e-mail when a new message is recorded in your mailbox. Click <b>Edit</b> for the extension to schedule, program the settings, and click <b>OK</b> to finish.</p> <p><b>Note</b></p> <p>You can be notified by e-mail when an outside call is missed. For details, refer to "Changing Your Contact Information" and "Changing E-mail Notification Settings" in "3.2.1 User Programming").</p> <p><b>User Name</b></p> <p>Specifies the name of the user of the device.</p> <p><b>E-mail Address</b></p> <p>Specifies the e-mail address of the device.</p> <p><b>Only Urgent Messages</b></p> <p>Specifies if Message Waiting Notifications will be sent only for urgent messages.</p> <p><b>Title Order</b></p> <p>Specifies the format of the title of the notification.</p>

### 3.2.1 User Programming

Item	Description
	<p><b>Title String</b> Specifies the text string to be included as part of the title of the notification.</p> <p><b>Callback Number</b> Specifies the callback number to be included in the notification (max. 32 digits).</p> <p><b>Send Wait Time [0-120 min]</b> Specifies the delay between the message being left and the sending of the Message Waiting Notification.</p> <p><b>Attach Voice File</b> Specifies whether to attach a voice file of the voice message to the notification e-mail.</p> <p><b>Use Mode</b> Specifies if and how each device is used for message notification:</p> <ul style="list-style-type: none"> <li>• <b>Not use:</b> The selected device is not used for message notification.</li> <li>• <b>Continuously:</b> The device is called whenever a message is recorded in the mailbox. If <b>Only Urgent Messages</b> is set to "Yes", the device is called whenever an urgent message is recorded in the mailbox.</li> <li>• <b>Scheduled:</b> The selected device is called only during the selected times.</li> </ul> <p><b>Time Frame:</b> If <b>Scheduled</b> is selected here, follow the steps below to specify the time frame:</p> <ol style="list-style-type: none"> <li>1. Click a day (<b>Sunday – Saturday</b>) tab.</li> <li>2. Click <b>Enable Time Frame No. 1</b> or <b>2</b>.</li> <li>3. Enter the start and end times in the "Start At (HH:MM)" and "End At (HH:MM)" fields.</li> <li>4. To specify if sent voice message is deleted from the Unified Message system after they are sent by e-mail, select "Yes" for <b>Delete After Send (Voice File)</b> or <b>Delete After Send (Fax File)</b>.</li> <li>5. Repeat steps 1 to 3 for each day to be programmed, and then Click <b>OK</b>.</li> </ol>

#### External Message Delivery

Item	Description
<b>External Message Delivery Active</b>	If set to "Yes", you are able to utilise the External Message Delivery feature.
<b>External Message Delivery Prompt Mode</b>	When an external message is delivered, the receiver will be greeted by the system in the specified language. If set to "Primary", the default language will be used. If set to "Selective", the receiver has a choice of prompts.

#### Auto Forwarding

Item	Description
<b>Auto Forwarding Active</b>	If set to "Yes", the Unified Messaging system automatically forwards messages that have not been played for a specified length of time to another mailbox.

Item	Description
<b>Auto Forwarding Mailbox Number</b>	<p>Specifies the mailbox to which the messages will be forwarded.</p> <p><b>Note</b> A Mailbox Group number cannot be specified as a destination.</p>
<b>Auto Forwarding Delay Time</b>	<p>Specifies the length of time in hours and minutes that the system waits before forwarding unplayed messages. The maximum delay time is 99 h, 59 min.</p> <p><b>Note</b> The delay time must be shorter than the New Message Retention Time, or else messages will be deleted before being forwarded.</p>
<b>Auto Forwarding Mode</b>	<p>Specifies if forwarded messages are to be retained in the original mailbox. When set to "Copy", copies of the messages are retained in the original mailbox after forwarding. When set to "Move", messages are forwarded to the receiving mailbox and are not retained in the original mailbox.</p>
<b>Auto Forwarding Mode - Message Remains New</b>	<p>Specifies if the forwarded messages remain marked as new. This setting is available only when <b>Auto Forwarding Mode</b> is set to "Copy".</p>
<b>Auto Forwarding Expires</b>	<p>Specifies the date and time of day for when forwarding of messages will expire.</p>

**Personal Custom Service**

Item	Description
<p><b>Personal Custom Service</b></p>	<p>Specifies the Personal Custom Service.</p> <p><b>Note</b></p> <ul style="list-style-type: none"> <li>• Make sure to add an outside line access number when you store an outside telephone number.</li> <li>• If you are using a PRI line, you may need to enter # at the end of outside telephone numbers.</li> </ul> <p>Follow the steps below to edit a Personal Custom Service.</p> <ol style="list-style-type: none"> <li>1. Click <b>Edit</b>.</li> <li>2. For each <b>Key</b>, specify an <b>Assigned Operation</b>.</li> <li>3. For each <b>Assigned Operation</b> that is specified, specify a <b>Value</b> from the following.               <ul style="list-style-type: none"> <li>• <b>Transfer to specified mailbox:</b> Allow the caller to leave messages in a specified mailbox.</li> <li>• <b>Transfer to specified extension:</b> Transfers the caller to a specified extension.</li> <li>• <b>Transfer to Voice Mail Service:</b> Allows the caller to access Voice Mail Service.</li> <li>• <b>Transfer to Automated Attendant Service:</b> Allows the caller to access Automated Attendant Service.</li> <li>• <b>Transfer to specified Custom Service Menu:</b> Transfers the caller to the Custom Service specified here.</li> <li>• <b>Transfer to operator:</b> Connects the caller to an operator.</li> <li>• <b>Transfer to outside (specified number):</b> Transfers the caller to a specified outside telephone number. Enter the Outside Numbers list index (1-4).</li> <li>• <b>Page the party:</b> Pages you.</li> <li>• <b>Repeat greeting:</b> Repeats the greeting.</li> <li>• <b>None:</b> No operation assigned.</li> </ul> </li> <li>4. Click <b>OK</b> when finished.</li> </ol>
<p><b>Outside Numbers</b></p>	<p>Specifies the outside telephone numbers that can be used for the "Transfer to outside (specified number)" operation in the <b>Personal Custom Service</b> settings.</p> <ol style="list-style-type: none"> <li>1. Click <b>Edit</b>.</li> <li>2. Enter Outside Number #1-#4: Max. 32 digits consisting of 0-9, *, #, and special codes:               <ul style="list-style-type: none"> <li>• <b>T:</b> Dial Tone Detection</li> <li>• <b>,:</b> Dial Pause (default 1 s)</li> <li>• <b>;;:</b> Dial Pause (default 3 s)</li> <li>• <b>0-9, *, #:</b> Dial Code</li> </ul> </li> <li>3. Click <b>OK</b> when finished.</li> </ol>



Item	Description
<b>No DTMF Input Operation</b>	Specifies the operation taken when no DTMF input (a caller does not dial anything) is received after the Personal Greeting: <ul style="list-style-type: none"> <li>• <b>Recording:</b> The caller will be guided to leave a message.</li> <li>• <b>Disconnect (All Day):</b> The line will be disconnected, regardless of the time of day.</li> <li>• <b>Disconnect (Only After Hours):</b> The line will be disconnected only after hours.</li> </ul>
<b>No DTMF Input Operation Wait Time</b>	Specifies the duration of time to wait for DTMF input before the action set in <b>No DTMF Input Operation</b> is performed (0–10 s).

#### Personal Distribution List

Item	Description
<b>List 1–4 Members</b>	<p>Personal Distribution Lists are used to send the same messages to several mailboxes in a single operation. A maximum of 4 lists can be maintained with each list containing a maximum of 40 mailboxes.</p> <p>Specifies the mailbox numbers that belong to the list.</p> <p>Follow the steps below to edit list members.</p> <ol style="list-style-type: none"> <li>1. Click <b>Edit</b> for a Personal Distribution List (1–4) Members item.</li> <li>2. Under <b>Subscribers To Add</b>, click the checkbox in <b>No.</b> for each mailbox to add, referring to the mailbox numbers and mailbox owners' names.</li> <li>3. Click <b>Add</b>.</li> <li>4. Click <b>OK</b>.</li> </ol> <p>Follow the steps below to remove members from a list.</p> <ol style="list-style-type: none"> <li>1. Click <b>Edit</b> for Personal Distribution Lists (1–4) Members item.</li> <li>2. Under <b>Distribution</b>, click the checkbox in <b>No.</b> for each mailbox to add, referring to the mailbox numbers and mailbox owners' names.</li> <li>3. Click <b>Delete</b>.</li> <li>4. Click <b>OK</b>.</li> </ol>

#### Remote Call

Item	Description
<b>Remote Call Telephone Number 1, 2 [0–9, *]</b>	<p>Specifies the telephone numbers of destinations to which callers are forwarded when you set Remote Call Forwarding. 2 telephone numbers can be specified per mailbox.</p> <p>Make sure you begin the telephone number with an outside line access number (to seize an outside line).</p> <p><b>Note</b></p> <p>This feature may be disabled by system programming for your mailbox.</p>

**Automatic Login**

item	Description
<b>Auto Login Extension</b>	When this item is set to "Enable", you are able to access your mailbox directly without entering the mailbox number. You can automatically log in from your extensions, by calling from an outside telephone whose number is stored as a Caller ID number, or by dialling a telephone number assigned to a specified DID number or trunk. When logging in from outside telephones, the Toll Saver feature is also available.
<b>Auto Login Extension Password Entry Requirement</b>	Specifies if a password is required for the Automatic Login Extension feature.  <b>Notice</b> If this is set to "No", ensure that unauthorised third-parties are not allowed access to that mailbox.
<b>Auto Login Caller ID 1, 2</b>	Specifies the telephone number from which you can automatically be logged in from. When Caller ID information is received that matches one of these numbers, the caller (you) is automatically logged in to the mailbox. Note that this telephone number must be unique for each mailbox.
<b>Auto Login Caller ID Password Entry Requirement</b>	Specifies if a password is required for entry when automatic login is performed using the Caller ID of the number set in <b>Auto Login Caller ID 1</b> or <b>Auto Login Caller ID 2</b> .  <b>Notice</b> If this is set to "No", ensure that unauthorised third-parties are not allowed access to that mailbox using the number assigned to <b>Auto Login Caller ID 1</b> or <b>Auto Login Caller ID 2</b> .
<b>Auto Login Toll Saver</b>	Allows you to call the Unified Messaging system and know whether or not new messages have been recorded in your mailbox by the number of rings you hear before the Unified Messaging system answers your calls. Toll Saver is available under the same conditions as Automatic Login; you can use Toll Saver when calling from an outside telephone whose number is stored as a Caller ID number, or by dialling a telephone number assigned to a specified DID number or trunk: <ul style="list-style-type: none"> <li>• <b>Disable:</b> Disables the Toll Saver feature.</li> <li>• <b>DID:</b> Toll Saver functions when the system receives the preprogrammed DID number from the PBX.</li> <li>• <b>Caller ID:</b> Toll Saver functions when Caller ID information is received that matches one of the preprogrammed numbers (Caller ID 1 or 2).</li> <li>• <b>Trunk:</b> Toll Saver functions when the system receives a call on the preprogrammed trunk.</li> </ul>

## Direct Service

Item	Description
<b>Direct Service UM Extension</b>	<p>Specifies which features can be directly accessed by dialling a Unified Messaging extension number:</p> <ul style="list-style-type: none"> <li>• <b>Record No Answer Greeting:</b> You can record the greeting played when there is no answer.</li> <li>• <b>Record Busy Greeting:</b> You can record the greeting played when their extension is busy.</li> <li>• <b>Record After Hours Greeting:</b> You can record the greeting played when the system is in night mode.</li> <li>• <b>Record Temporary Greeting:</b> You can record a greeting that is used exclusively until you disable it.</li> <li>• <b>Change Day Main Menu:</b> Change the Day Main Menu greeting. Only the Message Manager may make this change.</li> <li>• <b>Change Night Main Menu:</b> Change the Night Main Menu greeting. Only the Message Manager may make this change.</li> <li>• <b>Change Emergency Greeting:</b> Change the Emergency Greeting. Only the Message Manager may make this change.</li> </ul> <p><b>Note</b> Automatic Login must be enabled for extensions to use this Direct Service Access.</p>

## Announce Number of Messages

Item	Description
<b>Subscriber Service - All New Messages</b>	<p>Specifies if the system announces to you the number of only new messages in your mailbox when you log in.</p>
<b>Subscriber Service - All Messages</b>	<p>Specifies if the system announces to you the number of all messages in your mailbox when you log in.</p>
<b>Subscriber Service - New Voice Messages</b>	<p>Specifies if the system announces to you the number of only new voice messages in your mailbox when you log in.</p>
<b>Subscriber Service - New Urgent Messages</b>	<p>Specifies if the system announces to you the number of only new messages marked as urgent in your mailbox when you log in.</p>
<b>Receiving Message Service - All New Messages</b>	<p>Specifies if the system announces to you the number of only new messages in your mailbox when you have selected to listen to messages.</p>
<b>Receiving Message Service - All Messages</b>	<p>Specifies if the system announces to you the number all messages in your mailbox when you have selected to listen to messages.</p>
<b>Receiving Message Service - New Voice Messages</b>	<p>Specifies if the system announces to you the number of only new voice messages in your mailbox when you have selected to listen to messages.</p>
<b>Receiving Message Service - New Urgent Messages</b>	<p>Specifies if the system announces to you the number of only new urgent messages in your mailbox when you have selected to listen to messages.</p>

## 3.2.1 User Programming

### Message Client

Item	Description
<b>Message Client Display Language</b>	Specifies the language of information generated by the UM system for the mail (IMAP) client.

### Changing E-mail Notification Settings

You can set the e-mail notification settings for missed calls in the **Email Notification** tab of the **Edit User** screen. If **Enable** is selected, you will receive an e-mail at the address(es) specified in **Email 1–3** in the **Contact** tab when an outside call is missed (refer to "Changing Your Contact Information" in "3.2.1 User Programming").

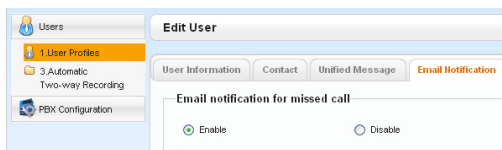

1. In the **Email Notification** tab, select **Enable** or **Disable** for **Email notification for missed call**.
2. Click **OK**.

### Changing Forward/Do Not Disturb Setting

You can change your extension's Forward/Do Not Disturb settings for outside and intercom calls in the **Telephony Feature** tab of the **Edit User** screen.

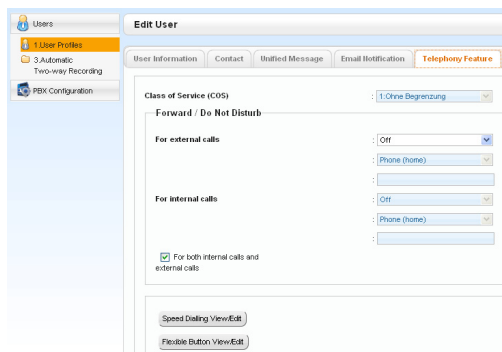

1. In the **Telephony Feature** tab, set Forward/Do Not Disturb as follows:
    - **For Outside Calls:**  
To specify the forward type, select the desired type from the **For external calls** drop-down list, then enter the telephone number or select **Phone (Home)**<sup>1</sup> or **Phone (Mobile)**<sup>1</sup> to specify the forward destination.
    - **For Intercom Calls:**  
To specify the forward type, select the desired type from the **For internal calls** drop-down list, then enter the telephone number or select **Phone (Home)**<sup>1</sup> or **Phone (Mobile)**<sup>1</sup> to specify the forward destination.
- <sup>1</sup> These phone numbers are set in the **Contact** tab of the **Edit User** screen.

#### Note

To apply settings to both outside and intercom calls, click **For both internal calls and external calls**. When you select this, the setting of **For external calls** is applied to both outside and intercom calls.

2. Click **OK**.

### Storing names and numbers in personal speed dialling

You can set frequently dialled numbers using two-digit speed dialling numbers (00–99). A maximum of 100 Personal Speed Dialling numbers can be programmed at your extension for your personal use.

1. In the **Telephony Feature** tab, click **Speed Dialling View/Edit**.

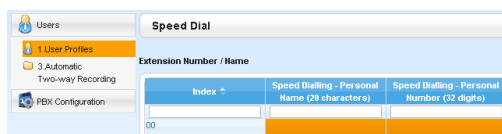

2. The available speed dialling numbers are shown in sets of 20. Select the desired set from **Index**.
3. Enter the name of the Personal Speed Dialling number to call in **Speed Dialling - Personal Name** (max. 20 characters).
4. Enter the number to be dialled by the Personal Speed Dialling number in **Speed Dialling - Personal Number** (max. 32 digits consisting of 0–9, \*, #, T [Transfer], [ ] [Secret], P [Pause], and F [Flash]).
5. Click **OK**.

### Customising the Flexible Buttons

You can customise the flexible buttons on PTs, Add-on Key Modules, PSs, KX-UT133/KX-UT136/KX-UT248/KX-UT670 SIP phones, and S-PSs. They can then be used to make or receive outside calls or as feature buttons.

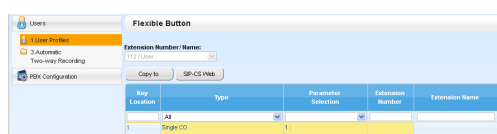

1. In the **Telephony Feature** tab, click **Flexible Button View/Edit**.
2. To set the flexible buttons, specify each button on the **Flexible Button** screen. Follow the table below to set each parameter. When you finish, click **OK**.

Button	Steps
Loop-CO (L-CO)	Select <b>Loop CO</b> from <b>Type</b> . To specify the ring tone, select the ring tone type from <b>Optional Parameter (Ringing Tone Type Number)</b> .
Group-CO (G-CO)	Select <b>Group CO</b> from <b>Type</b> . Then specify the outside line group number in <b>Parameter Selection</b> . To specify the ring tone, select the ring tone type from <b>Optional Parameter (Ringing Tone Type Number)</b> .
Single-CO (S-CO)	Select <b>Single CO</b> from <b>Type</b> . Then specify the outside line number in <b>Parameter Selection</b> . To specify the ring tone, select the ring tone type from <b>Optional Parameter (Ringing Tone Type Number)</b> .
Direct Station Selection (DSS)	Select <b>DSS</b> from <b>Type</b> . Then enter the extension number in <b>Extension Number</b> .

### 3.2.1 User Programming

Button	Steps										
One-touch Dialling	<p>Select <b>One-touch</b> from <b>Type</b>. Then enter the desired number in <b>Dial</b> (max. 32 digits consisting of 0–9, *, #, T [Transfer], [ ] [Secret], P [Pause], and F [Flash]).</p> <p><b>Note</b></p> <ul style="list-style-type: none"> <li>If you store an outside party's number, you should first store a line access number. If you need to enter an account code, you can enter the specified account code before the line access number.</li> </ul> <p><b>&lt;Example&gt;</b></p> <div style="text-align: center; margin: 10px 0;"> <table style="border: none; margin: auto;"> <tr> <td style="text-align: center;">*49</td> <td style="text-align: center;">1234</td> <td style="text-align: center;">#</td> <td style="text-align: center;">0/9</td> <td style="text-align: center;">SECRET 123 4567</td> </tr> <tr> <td style="text-align: center; font-size: small;">Account code feature no.</td> <td style="text-align: center; font-size: small;">Account code</td> <td style="text-align: center; font-size: small;">Account code delimiter</td> <td style="text-align: center; font-size: small;">Automatic line access number</td> <td style="text-align: center; font-size: small;">Phone number</td> </tr> </table> </div> <ul style="list-style-type: none"> <li><b>For KX-UT series SIP phones and S-PS users:</b> Use only 0–9, *, and # for One-touch Dialling buttons. If characters other than these are stored, they will be considered invalid. Only the digits up to an invalid character will be sent when using that One-touch Dialling button.</li> </ul>	*49	1234	#	0/9	SECRET 123 4567	Account code feature no.	Account code	Account code delimiter	Automatic line access number	Phone number
*49	1234	#	0/9	SECRET 123 4567							
Account code feature no.	Account code	Account code delimiter	Automatic line access number	Phone number							
Incoming Call Distribution Group (ICD Group)	<p>Select <b>ICD Group</b> from <b>Type</b>. Then enter the incoming call distribution group extension number in <b>Extension Number</b>. To specify the ring tone, select the ring tone type from <b>Optional Parameter (Ring Tone Type Number)</b>.</p>										
Message	<p>Select <b>Message Waiting</b> from <b>Type</b>.</p>										
Message for Another Extension	<p>Select <b>Message Waiting</b> from <b>Type</b>. Then enter the extension number or incoming call distribution group extension number in <b>Extension Number</b>.</p>										
Call Forwarding (FWD)/Do Not Disturb (DND)—Both calls	<p>Select <b>FWD/DND (Both)</b> from <b>Type</b>.</p>										
FWD/DND—Outside calls	<p>Select <b>FWD/DND (External)</b> from <b>Type</b>.</p>										
FWD/DND—Intercom calls	<p>Select <b>FWD/DND (Internal)</b> from <b>Type</b>.</p>										
Group FWD—Both calls	<p>Select <b>Group Fwd (Both)</b> from <b>Type</b>. Then enter the incoming call distribution group extension number in <b>Extension Number</b>.</p>										
Group FWD—Outside calls	<p>Select <b>Group Fwd (External)</b> from <b>Type</b>. Then enter the incoming call distribution group extension number in <b>Extension Number</b>.</p>										
Group FWD—Intercom calls	<p>Select <b>Group Fwd (Internal)</b> from <b>Type</b>. Then enter the incoming call distribution group extension number in <b>Extension Number</b>.</p>										
Account	<p>Select <b>Account</b> from <b>Type</b>.</p>										

Button	Steps
Conference	Select <b>Conference</b> from <b>Type</b> .
Terminate	Select <b>Terminate</b> from <b>Type</b> .
External Feature Access (EFA)	Select <b>EFA</b> from <b>Type</b> .
Call Charge Reference	Select <b>Charge</b> from <b>Type</b> .
Call Park	Select <b>Call Park</b> from <b>Type</b> . Then select <b>Specific</b> from <b>Parameter Selection</b> . Specify the number of the parking zone a call is to be parked in <b>Optional Parameter (Ringing Tone Type Number)</b> .
Call Park (Automatic Park Zone)	Select <b>Call Park</b> from <b>Type</b> . Then select <b>Automatic</b> from <b>Parameter Selection</b> .
Call Log	Select <b>Call Log</b> from <b>Type</b> .
Call Log for ICD Group	Select <b>Call Log</b> from <b>Type</b> . Then enter the incoming call distribution group extension number in <b>Extension Number</b> .
Log-in/Log-out	Select <b>Log-in/Log-out</b> from <b>Type</b> . Then select <b>None</b> from <b>Parameter Selection</b> .
Log-in/Log-out of a specified group	Select <b>Log-in/Log-out</b> from <b>Type</b> . Then select <b>Incoming Group</b> from <b>Parameter Selection</b> . And, enter the Incoming call distribution group extension number in <b>Extension Number</b> .
Log-in/Log-out for all groups	Select <b>Log-in/Log-out</b> from <b>Type</b> . Then select <b>All</b> from <b>Parameter Selection</b> .
Hurry-up	Select <b>Hurry-up</b> from <b>Type</b> . Then enter the incoming call distribution group extension number in <b>Extension Number</b> .
Wrap-up	Select <b>Wrap-up</b> from <b>Type</b> .
System Alarm	Select <b>System Alarm</b> from <b>Type</b> .
Time Service (Day/Night/Lunch/Break)	Select <b>Time Service</b> from <b>Type</b> . Then in <b>Parameter Selection</b> , select which time modes will be switched manually. In <b>Optional Parameter (Ringing Tone Type Number)</b> , select the Time Table (tenant number) to be used for changing time modes in Automatic Switching mode.
Answer	Select <b>Answer</b> from <b>Type</b> .
Release	Select <b>Release</b> from <b>Type</b> .
Toll Restriction/Call Barring	Select <b>TRS Level Change</b> from <b>Type</b> . Then select the Toll Restriction/Call Barring Level (1–7) from <b>Parameter Selection</b> .

### 3.2.1 User Programming

Button	Steps
ISDN Service	<p>Select <b>ISDN Service</b> from <b>Type</b>. Then enter the desired number in <b>Dial</b> (max. 32 digits consisting of 0–9, *, #, T [Transfer], [ ] [Secret], P [Pause], and F [Flash]).</p> <p><b>Note</b> Availability of this button depends on the ISDN service of your telephone company. Refer to "1.2.5 Accessing the ISDN Service (ISDN Service Access)".</p>
Calling Line Identification Restriction (CLIR)	Select <b>CLIR</b> from <b>Type</b> .
Connected Line Identification Restriction (COLR)	Select <b>COLR</b> from <b>Type</b> .
ISDN-Hold	Select <b>ISDN Hold</b> from <b>Type</b> .
Headset	Select <b>Headset</b> from <b>Type</b> .
Time Service Switching Mode (Automatic/Manual)	<p>Select <b>Time Service - Automatic/Manual</b> from <b>Type</b>. Then in <b>Parameter Selection</b>, select the Time Table (tenant number) to be used when Time Service Switching Mode is set to Automatic.</p>
Network Direct Station Selection (NDSS)	<p>Select <b>NDSS</b> from <b>Type</b>. Then enter the another PBX extension number in <b>Dial</b> (max. 16 digits consisting of 0–9).</p> <p><b>Note</b> The button may not be available depending on the networking method in use or the settings of the PBX.</p>
CTI	Select <b>CTI</b> from <b>Type</b> .
Primary Directory Number (PDN)	Select <b>PDN</b> from <b>Type</b> .
Secondary Directory Number (SDN)	<p>Select <b>SDN</b> from <b>Type</b>. Then enter the extension number in <b>Extension Number</b>. In <b>Parameter Selection</b>, specify the delayed ringing setting for calls arriving at an SDN button. To specify the ring tone, select the ring tone type from <b>Optional Parameter (Ringing Tone Type Number)</b>.</p>
Check-in	Select <b>Check In</b> from <b>Type</b> .
Check-out	Select <b>Check Out</b> from <b>Type</b> .
Cleaned-up	Select <b>Cleaned Up</b> from <b>Type</b> .
Two-way Record	<p>Select <b>Two-way Record</b> from <b>Type</b>. Then enter the UM group's floating extension number in <b>Extension Number</b>. (The UM group's default floating extension number is 500.<sup>1</sup>)</p>



Button	Steps
Two-way Transfer	Select <b>Two-way Transfer</b> from <b>Type</b> . Then enter the UM group's floating extension number in <b>Extension Number</b> . (The UM group's default floating extension number is 500. <sup>*1</sup> ) Specify the number of the extension whose mailbox will be used to record conversations using One-touch Two-way Transfer in <b>Ext No. of Mailbox</b> . (For example, a secretary can record a conversation into the mailbox of a boss.) If the cell is left empty, the extension user must specify the number of an extension each time.
One-touch Two-way Transfer	Select <b>Two-way Transfer</b> from <b>Type</b> . Then enter the UM group's floating extension number in <b>Extension Number</b> . (The UM group's default floating extension number is 500. <sup>*1</sup> ) Enter extension number or incoming call distribution group extension number to <b>Ext No. of Mailbox</b> .
Live Call Screening (LCS)	Select <b>LCS</b> from <b>Type</b> .
Voice Mail Transfer	Select <b>Voice Mail Transfer</b> from <b>Type</b> . Then enter the UM group's floating extension number in <b>Extension Number</b> . (The UM group's default floating extension number is 500. <sup>*1</sup> )
DN	Select <b>DN</b> from <b>Type</b> .

<sup>\*1</sup> The UM group's default floating extension number depends on system programming. For more information, consult your System Administrator or System Manager.



- For KX-NT366 and KX-NT553/KX-NT556/KX-NT560 users: You can set the text displayed for each flexible button for the phone's Self Labelling feature in **Label Name** on the **Flexible Button** screen.
- For KX-UT248 and KX-UT670 users: You can set the text displayed (a maximum of 10 characters) for each flexible button for the phone's Self Labelling feature in **Label Name** on the **Flexible Button** screen.

## Changing Your Password

You can change your password for the Web Maintenance Console in the **Login Account** tab of the **Edit User** screen.

- In the **Login Account** tab, **Password** (4–16 characters in length) can be edited.

### Note

Entry for the password is hidden and displayed as dots ".".

- Click **OK**.

## ◆◆ Automatic Two-way Recording for Manager

If you are designated as a supervisor for Automatic Two-way Recording, you can set the recording for extensions you are supervising and listen to the recorded conversations as messages through Web Maintenance Console. Calls to and from specified extensions can be automatically recorded to a mailbox. For each targeted extension, the following types of calls can be recorded:

- Intercom (internal) calls
- Outside (external) calls

### 3.2.1 User Programming

---

- Incoming ICD group calls only (i.e., when recording outside calls, limit recording to incoming ICD group calls only)



- This screen is accessible only by users designated as Automatic Two-way Recording supervisors.
- Forwarded calls and calls retrieved from being on hold will also be automatically recorded. However, conference calls will not be recorded.
- Recording will automatically stop when the mailbox reaches its capacity. Delete older messages in order to use this feature again.
- If the enabled extension has a Two-way Record button assigned to it, the button will flash during recording. However, that button cannot be used to cancel this feature.
- An extension whose conversation is being recorded cannot be the target of the following features:
  - Executive Busy Override
  - Call Monitor
  - Whisper OHCA
- Automatic recording will not be performed when both the target extension and the other party are ISDN extensions.

#### **Note**

You should inform the other party that the conversation will be recorded.

### Editing Recording Settings

On this screen, a user designated as a supervisor may change Automatic Two-way Recording settings for extensions they are supervising. Information for each extension, including the extension's supervisor, UM Group number, and Automatic Two-way Recording destination mailbox is displayed. You can specify which types of calls will be recorded for each extension.

1. On the left side of the screen, click **Users** → **Automatic Two-way Recording** → **Edit a Recording**.
2. For an extension, click the setting for **Internal call**, **External Call**, or **ICDG Incoming Only**.
  - **Internal call**: Extension-to-extension calls are recorded.
  - **External Call**: Calls with outside parties are recorded.
  - **ICDG Incoming Only**: Only calls that are received by the extension through an incoming call distribution group are recorded.

#### **Note**

To set **ICDG Incoming Only** to "On", **External Call** must first be set to "On".

3. Select **On** or **Off** for that setting.
4. Click **OK** when finished.

### Viewing and Playing Messages

Users designated as supervisors can view and play messages recorded using the Automatic Two-way Recording feature.

1. On the left side of the screen, click **Users** → **Automatic Two-way Recording** → **Record List**.
2. Select a UM group number from the **Select a Destination UM-Group No.** drop-down list.
3. Click **List View** to display a list of the Automatic Two-way Recording mailboxes of the selected UM group.
4. Select one or more mailboxes, and click **OK**.
5. Messages recorded in the selected mailbox(es) will be displayed. You can filter the list of messages displayed or play a message.

#### **To filter the list of messages:**

Specify any number of the following conditions, and then click **Search** to display the messages that match those conditions.

- **Mailbox**: Specify an Automatic Two-way Recording mailbox, or select **ALL**.

- **Extension:** Specify an extension to view all calls that were recorded using Automatic Two-way Recording for that extension, or select **ALL**.
- **Status:** Specify the status for the recorded messages in the mailbox.
- **Internal/External:** Specify whether the recorded conversations were intercom calls or external calls, or specify both.
- **Call Type:** Specify whether the recorded conversations were incoming calls or outgoing calls, or specify both.
  - If **Internal/External** is set to "Internal" or "Both", **Call Type** will be set to "Both".
  - If **Internal/External** is set to "External", **Call Type** can be set to "Incoming", "Outgoing", or "Both".
- **Phone Number:** Specify the phone number of the party calling the recorded extension.
- **Caller Name:** Specify the name of the party that called the recorded extension (may not be available for all recorded messages).
- **Length:** Specify the length of the recorded conversations.
- **Period:** Specify a time period in which calls were recorded.

### To play a message:



#### For playback on the PC:

1. Select the check box of a message to play.
2. At the bottom of the screen, select **PC**.
3. Click the  (**play**) button.  
The message will be downloaded as an audio file for playback on the PC being used to connect to Web Maintenance Console.

#### For playback using the supervisor's designated extension:

1. In the **Mailbox** filter, select the mailbox whose messages you want to display, and then click **Search**.
2. Select the check boxes for one or more messages to play.
3. At the bottom of the screen, select **Phone**.
4. Click the  (**play**) button.

#### Note

- If **ALL** has been selected for the **Mailbox** filter, the  (**play**) button will be disabled. Select a specific mailbox to enable the  (**play**) button.
5. In the window that appears, enter the extension number in **Specify Extension** of the extension at which to play back the messages, and then click **Connect**.
  6. Go off-hook when the extension rings to establish a call with the UM message playback system.
  7. During the call, click **Play** to listen to the currently selected message. If multiple messages were selected in step 1, you can click **Prev** and **Next** to cycle through and listen to the selected messages.
  8. When you are finished listening to messages, click **Disconnect** or go on-hook.

## ◆◆ Logout

To logout of Web Maintenance Console, click the  (**logout**) button to end the programming session and return to the Login screen. When this option is chosen, system data is automatically backed up from the PBX to the System Memory.

1. Click the  (**logout**) button.  
A confirmation message will be displayed.
2. Click **Yes**.



- If the computer running the Web browser that is connected to Web Maintenance Console is shut down, or the Web browser is closed, any changes that have not been saved will be lost. Always end your programming session by clicking the  (**logout**) button. For more information, consult your System Administrator.



---

## **Section 4**

# ***Customising Extensions and the System—for Managers***

*This section shows managers how to customise the PBX's extension and system settings according to their needs. Find the desired setting and program as necessary.*

## 4.1 Manager Programming

### 4.1.1 Programming Information

The manager can programme the following items.

- Call Charges
- Other Extensions Control

#### **Available Extension**

The extension assigned as a manager

#### **Required Telephone**

A Panasonic Proprietary Telephone with display (2 lines or more)  
(e.g., KX-NT343, KX-NT546, KX-DT346, KX-DT546, KX-T7636)

#### **Manager Password**

To enter programming mode, the manager password (max. 10 digits) is required. (Default: 1234)

#### **CAUTION**

- The PBX has a default password preset. For security, change the password the first time that you programme the PBX.
- It is strongly recommended that a password of 10 numbers or characters be used for maximum protection against unauthorised access. For a list of numbers and characters that can be used in the password, refer to "◆◆ Entering Characters".
- To avoid unauthorised access to the PBX, keep the password secret. If it becomes known to others, the PBX may be misused.
- Change the password periodically.

#### **Conditions**

The programming extension must be idle, on-hook and holding no calls.

## 4.1.2 Manager Programming



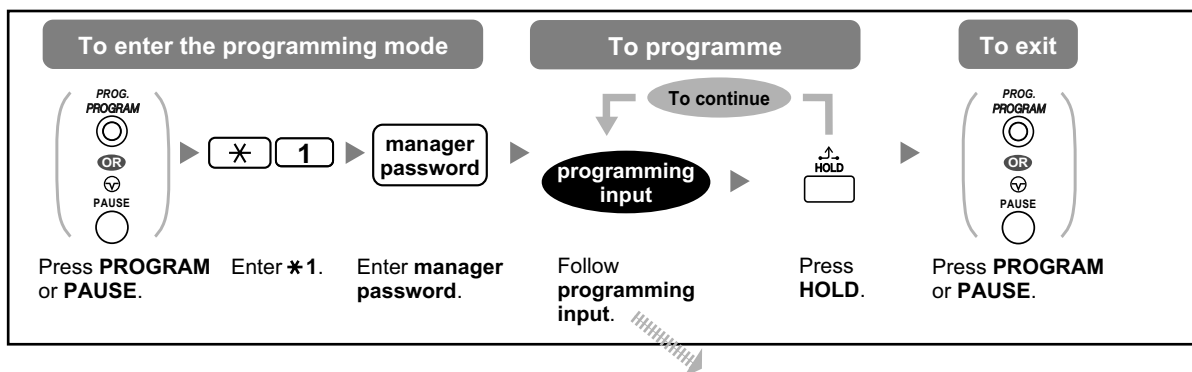

### ◆◆ Changing Call Charges and Extension Control



Item	Programming Input
Changing the manager password.	<b>0</b> <b>0</b> +  + Password (max. 10 digits) +
Viewing extension call charges.	<b>0</b> <b>1</b> +  + Extension no.
Clearing extension call charges.	<b>0</b> <b>1</b> +  + Extension no. +  +
Setting the budget for extension call charges.	<b>0</b> <b>2</b> +  + Extension no. + Charge* +
Viewing call charges for each verification code.	<b>0</b> <b>3</b> +  + Verification code
Clearing call charges for each verification code.	<b>0</b> <b>3</b> +  + Verification code +  +
Setting the budget for each verification code.	<b>0</b> <b>4</b> +  + Verification code + Charge* +
Viewing call charges for each outside line.	<b>0</b> <b>5</b> +  + Outside line no. (3 digits)
Assigning a charge rate for each outside line group.	<b>0</b> <b>6</b> +  + Outside line group no. (2 digits) + Charge rate* +
Clearing all charges.	<b>0</b> <b>7</b> +  +
Printing the total call charge.	<b>0</b> <b>8</b> +  +
Locking/unlocking other extensions. (Remote Extension Dial Lock)	<b>9</b> <b>0</b> +  + Extension no. + <b>1</b> (to lock)/ <b>0</b> (to unlock) +
Clearing the PIN and PIN lock for extensions.	<b>9</b> <b>1</b> +  + Extension no. +
Clearing the PIN and PIN lock for verification codes.	<b>9</b> <b>2</b> +  + Verification code +

#### 4.1.2 Manager Programming

---

Item	Programming Input
Setting the verification code PIN.	  +  + Verification code + PIN (max. 10 digits) + 



#### **CAUTION**

There is a risk that fraudulent telephone calls will be made if a third party discovers your password (verification code PIN).

The cost of such calls will be billed to the owner/renter of the PBX.

To protect the PBX from this kind of fraudulent use, we strongly recommend:

- a.** Keeping your PIN secret.
  - b.** Selecting a complex, random PIN that cannot be easily guessed.
  - c.** Changing your PIN regularly.
- \* To enter a decimal point, press \* .



## 4.1.3 Supervisory Monitor (ACD) Control

- ◆◆ Monitor Control & Execute
- ◆◆ ACD Report Analysis

### ◆◆ Monitor Control & Execute

A user designated as an ACD Supervisor or Administrator can specify certain ICD groups to monitor and configure the monitoring settings. Finally, the user can start the monitor.

#### To configure the monitor settings and start monitoring

You can configure the monitor control settings in the **Group Monitor** of the **ICDG Management** in Web Maintenance Console.

1. On the left side of the screen, click **Users** → **ICDG Management** → **Group Monitor**.
2. Select an ACD Supervisor from the **Supervisor selection** drop-down list.
3. On the **Layout** of the **Basic Settings**, select the layout for showing the monitor results.
4. Select the ICD Group that you want to monitor from the **Select ICD Group** drop-down list.
5. On the **Options**, you can change the following settings for the monitor screen:

Item		Description	Value
<b>Member Status View Mode</b>		Select the display mode for members' status.	<b>Standard, Simple</b>
<b>Highlighted Display Settings</b>	<b>Number of Current Waiting Calls (1-30)</b>	Specify the number of waiting calls at which the <b>Current Waiting Calls</b> display is highlighted.	1–30
	<b>Waiting Time (0-10 min/10 sec)</b>	Specify the waiting time at which the <b>Longest Waiting Time</b> display is highlighted.	0–10 minutes
	<b>Colour Mode</b>	Select the colour to use to highlight items on the screen.	<b>Mode 1, Mode 2, Mode 3</b>
	<b>Blinking</b>	Select whether items that are highlighted on the screen blink.	<b>Enable, Disable</b>

6. Click **Apply**.
7. When you finish configuring the settings, click **Start Monitor** to start monitoring the selected ICD group.
8. Click **Close**.
9. Click **OK**.

### ◆◆ ACD Report Analysis

You can specify which items to include in the monitor result report, the style in which to display the report profile, and the output format.

1. On the left side of the screen, click **Users** → **ICDG Management** → **ACD Report**.
2. Select an ACD Supervisor from the **Supervisor selection** drop-down list.

#### To load an ACD report

- a. Click **Report Profiles**.
- b. Select the **Profile Name**.

- c. Click **Load**.

#### To save an ACD report

- a. Click **Report Profiles**.
- b. Name the **Profile Name** (max. 32 characters).
- c. Click **Save**.

#### To select ACD report options

- a. Click **Option**.
- b. In **ACD Report - Export CSV File Format**, select either **Comma(,)** or **Semicolon(;)** as the data separator.
- c. Click **OK**.

You can make an ACD report through 3 types of filters: **Group**, **Agent**, and **Call**. On the ICD screen, select the target tab, configure the settings as necessary and then click **Apply**.

#### For Group

1. On the **Group** tab under **Filter Settings**, select one of the following items in the **View Mode** drop-down list:

**Group, Hour, Day, Date, Month, Trunk, Caller ID/CLIP**

##### Note

If you select **Hour**, specify the time range (0:00–23:59) in **Range**.

2. On the **Group—Filter Settings—Select Group** screen, set the groups to analyse as follows:
  - a. Click **Select**.
  - b. Click the ICD group name you want to analyse from the ICD group names displayed on the **Available Group for ACD Report** window. (Maximum 64 groups displayed)
  - c. Click **==>** to move the ICD group you selected in step b. to the **Selected Group for ACD Report** window. (Maximum 64 groups)  
To delete an ICD group from the **Selected Group for ACD Report** window, click the ICD group name, and then click **<==**.
  - d. Click **OK**.
3. Select the target time period for the ACD report on **Group—Filter Settings—Select Period**.
4. To show the report on a group basis, perform the following steps:
  - a. Click **View Report**.  
The **ACD Report - Group Report** screen is displayed.
  - b. The results report can be output in one of the following 3 ways:
    - **Graph**: Click **Graph**, open the **ACD Report - Group Graph** screen, and display the graph of the report. Click **Print** to print the graph.
    - **Export**: Click **Export**, and save the report file.
    - **Print**: Click **Print** to print the report.
  - c. Click **Close**.

#### For Agent

1. On the **Agent** tab under **Filter Settings**, select one of the following items in the **View Mode** drop-down list:

**Agent, Hour, Day, Date, Month**

##### Note

If you select **Hour**, specify the time range (0:00–23:59) in **Range**.

2. On the **Agent—Filter Settings—Select Agent** screen, set the groups to analyse as follows:
  - a. Click **Select**.

- b. Click the agent name you want to analyse from the displayed agent names on **Available Agent for ACD Report** window.
  - c. Click **==>** to move the agent you selected in step b. to the **Selected Agent for ACD Report** window. (Maximum 128 agents)  
To delete an agent from the **Selected Agent for ACD Report** window, click the agent name, and then click **<==**.
  - d. Click **OK**.
3. Select the target time period for the ACD report on **Agent—Filter Settings—Select Period**.
  4. To show the report on an agent basis, perform the following steps:
    - a. Click **View Report**.  
The **ACD Report - Agent Report** screen is displayed.
    - b. The results report can be output in one of the following 3 ways:
      - **Graph**: Click **Graph**, open the **ACD Report - Agent Graph** screen, and display the graph of the report. Click **Print** to print the graph.
      - **Export**: Click **Export**, and save the report file.
      - **Print**: Click **Print** to print the report.
    - c. Click **Close**.

### For Call

1. On the **Call—Filter Settings—Select Group** screen, set the group to analyse as follows:
  - a. Click **Select**.
  - b. Click the ICD group name you want to analyse from the ICD group names displayed on the **Available Group for ACD Report** window. (Maximum 64 groups displayed)
  - c. Click **==>** to move the ICD group you selected in step b. to the **Selected Group for ACD Report** window. (Maximum 64 groups)  
To delete an ICD group from the **Selected Group for ACD Report** window, click the ICD group name, and then click **<==**.
  - d. Click **OK**.
2. Select the target time period for the ACD report on **Call—Filter Settings—Select Period**.
3. Select the target for an ACD report from the following, and then configure the filter settings on the **Call—Call Filter Mode** screen.
  - **Caller ID/CLIP Filter**: You can filter by Caller ID or CLIP.
    - a. Click **Caller ID/CLIP Filter**.
    - b. Enter the caller ID or CLIP as the target to analyse (maximum 10).
  - **Talk/Wait Duration Filter**: You can filter by continuous talk time or wait time.
    - a. Click **Talk/Wait Duration Filter**.
    - b. Select **Talk Time** or **Wait Time** from the **Mode** drop-down list.
    - c. Set the target time range to filter.  
To set the minimum time duration, click **Min.**, and set the time (0:00–23:59).  
To set the maximum time duration, click **Max.**, and set the time (0:00–23:59).
  - **Lost Call Filter**: You can filter by lost calls.
    - a. Click **Lost Call Filter**.
4. To show the report on a group basis, perform the following steps:
  - a. Click **View Report**.  
The **ACD Report - Call Report** screen is displayed.
  - b. The results report can be output in one of the following 2 ways:
    - **Export**: Click **Export**, and save the report file.
    - **Print**: Click **Print** to print the report.
  - c. Click **Close**.

### 4.1.3 Supervisory Monitor (ACD) Control

---

---

## **Section 5**

### **Appendix**

*This section provides the List of Operations by Telephone Type, the Troubleshooting, the Feature Number Table and Tone List. Check the Troubleshooting section before consulting your dealer.*

## 5.1 List of Operations by Telephone Type

### 5.1.1 List of Operations by Telephone Type

The features that each type of telephone supports are marked with a ✓. Features without a ✓ for a certain telephone type are not supported for that telephone type.



- Some operations of these features may not be supported by a certain telephone type. For details, refer to the each section's operations.

Features	Telephone Type					
	PT	PS	SLT	SIP phone		S-PS
				KX-UT series	Non-KX-UT series	
<b>1.2.1 Basic Calling</b>						
◆◆ Calling Another Extension	✓	✓	✓	✓	✓	✓
◆◆ Calling an Outside Party	✓	✓	✓	✓	✓	✓
◆◆ Making a Call to a Private Network (TIE Line Access)	✓	✓	✓	✓	✓	✓
◆◆ Using an Account Code (Account Code Entry)	✓	✓	✓	✓	✓	✓
<b>1.2.2 Easy Dialling</b>						
◆◆ With a One-touch Button (One-touch Dialling)	✓	✓		✓ <sup>1</sup>		✓
◆◆ Using Numbers Stored at Your Extension (Personal Speed Dialling)	✓		✓	✓	✓	✓
◆◆ Using Numbers Stored in the PBX (System Speed Dialling)	✓	✓	✓	✓	✓	✓
◆◆ To a Preset Number by Going Off-hook (Hot Line)	✓	✓	✓			
◆◆ Using a Preprogrammed Number (Quick Dialling)	✓	✓	✓	✓	✓	✓
<b>1.2.3 Redial</b>	✓	✓	✓	✓	✓	✓
<b>1.2.4 When the Dialed Line is Busy or There is No Answer</b>						
◆◆ Reserving a Busy Line (Automatic Callback Busy)	✓	✓	✓			
◆◆ Setting Callback on an ISDN Line (Completion of Calls to Busy Subscriber [CCBS])	✓	✓	✓			

## 5.1.1 List of Operations by Telephone Type

Features	Telephone Type					
	PT	PS	SLT	SIP phone		S-PS
				KX-UT series	Non-KX-UT series	
◆◆ Sending a Call Waiting Notification (Call Waiting)	✓	✓	✓			
◆◆ Leaving a Message Waiting Indication/ Calling Back the Caller Who Left an Indication (Message Waiting)	✓	✓	✓	✓	✓	✓
◆◆ Joining an Existing Call (Executive Busy Override)	✓	✓	✓			
◆◆ Monitoring Another Extension (Call Monitor)	✓	✓	✓			
◆◆ To an Extension Refusing the Call (DND Override)	✓	✓	✓			
1.2.5 Accessing the ISDN Service (ISDN Service Access)	✓	✓				
1.2.6 Alternating the Calling Method (Alternate Calling—Ring/Voice)	✓	✓	✓			
1.2.7 Calling without Restrictions						
◆◆ Using Your Calling Privileges at Another Extension (Remote COS Access)	✓	✓	✓	✓	✓	✓
1.2.9 Setting Your Telephone from Another Extension or through DISA (Remote Setting)	✓	✓	✓			
1.3.1 Answering Calls	✓	✓	✓	✓	✓	✓
1.3.2 Answering Hands-free (Hands-free Answerback)	✓	✓		✓		✓
1.3.3 Answering a Call Ringing at Another Telephone (Call Pickup)						
◆◆ Answering a Call from Another Telephone (Call Pickup)	✓	✓	✓	✓	✓	✓
◆◆ Denying Other People the Possibility of Picking Up Your Calls (Call Pickup Deny)	✓	✓	✓	✓	✓	✓
1.3.4 Answering a Call via an External Speaker (Trunk Answer From Any Station [TAFAS])	✓	✓	✓			
1.3.5 Using the ANSWER/RELEASE Button	✓					
1.3.6 Identifying Malicious Calling Parties (Malicious Call Identification [MCID])	✓	✓	✓			
1.4.1 Transferring a Call (Call Transfer)						
◆◆ Transferring to an Extension in the PBX	✓	✓	✓	✓	✓	✓

### 5.1.1 List of Operations by Telephone Type

Features	Telephone Type					
	PT	PS	SLT	SIP phone		S-PS
				KX-UT series	Non-KX-UT series	
◆◆ Transferring to an Outside Party Using the PBX Service	✓	✓	✓	✓	✓	✓
◆◆ Transferring a Call Using the ISDN Service (Call Transfer [CT]—by ISDN)	✓	✓	✓			
◆◆ Transferring to an Outside Party Using the SIP Service	✓	✓	✓			
1.4.2 Holding a Call	✓	✓	✓	✓	✓	✓
1.4.3 Talking to Two Parties Alternately (Call Splitting)	✓	✓	✓	✓		✓
1.4.4 Answering Call Waiting	✓	✓	✓	✓		✓
1.4.5 Multiple Party Conversation						
◆◆ Adding Other Parties during a Conversation (Conference)	✓	✓	✓	✓		✓
◆◆ Leaving a Conference (Unattended Conference)	✓	✓				
◆◆ Leaving a Conference (Leaving Three-party Conference)	✓	✓	✓	✓		✓
◆◆ Letting a Third Party Join Your Call (Privacy Release)	✓	✓				
◆◆ Adding a Third Party during a Conversation Using the ISDN Service (Three-party Conference [3PTY]—by ISDN)	✓	✓	✓			
1.4.6 Mute	✓	✓		✓		✓
1.4.7 Letting Other People Listen to the Conversation (Off-hook Monitor)	✓			✓		
1.4.8 Using the Headset (Headset Operation)	✓			✓		✓
1.5.1 Primary Directory Number (PDN)/Secondary Directory Number (SDN) Extension	✓	✓				
1.6.1 Forwarding Calls						
◆◆ Forwarding Your Calls (Call Forwarding [FWD])	✓	✓	✓	✓	✓	✓
◆◆ FWD/DND Settings Using Fixed FWD/DND Button	✓			✓ <sup>2</sup>		



## 5.1.1 List of Operations by Telephone Type

Features	Telephone Type					
	PT	PS	SLT	SIP phone		S-PS
				KX-UT series	Non-KX-UT series	
◆◆ Forwarding Your Calls Using ISDN Service (Call Forwarding [CF]—by ISDN)	✓	✓	✓			
1.6.2 Showing a Message on the Caller's Telephone Display (Absent Message)	✓	✓	✓	✓	✓	✓
1.6.3 Preventing Other People from Using Your Telephone (Extension Dial Lock)						
To lock	✓	✓	✓	✓	✓	✓
To unlock	✓	✓	✓	✓	✓	✓
To make an outside call while your extension is locked	✓	✓	✓			
1.6.4 Using Voice Messaging (Built-in Simplified Voice Message [SVM])						
◆◆ Recording a Normal Greeting Message	✓	✓	✓			
◆◆ Recording a Greeting Message for Each Time Mode	✓	✓	✓			
◆◆ Redirecting Your Calls to Your Message Box	✓	✓	✓			
◆◆ Leaving Voice Messages	✓	✓	✓			
◆◆ Listening to Voice Messages Left by Callers	✓	✓	✓			
◆◆ Accessing Your Message Box from an Outside Telephone						
◆◆ Accessing the Message Box of Another Extension from Your Extension	✓	✓	✓			
1.7.1 Paging						
◆◆ Group Paging	✓	✓	✓	✓	✓	✓
◆◆ Paging and then Transferring a Call	✓	✓	✓	✓	✓	✓
1.7.2 Answering/Denying a Paging Announcement						
To answer	✓	✓	✓	✓	✓	✓
To allow/deny a paging announcement (Paging Deny)	✓			✓		
1.7.3 Making a Conference Group Call						
◆◆ Conference Mode	✓	✓	✓	✓	✓	✓
◆◆ Broadcast Mode	✓	✓	✓	✓	✓	✓

### 5.1.1 List of Operations by Telephone Type

Features	Telephone Type					
	PT	PS	SLT	SIP phone		S-PS
				KX-UT series	Non-KX-UT series	
◆◆ Join After Time Out	✓	✓	✓	✓	✓	✓
1.8 Using the Unified Messaging Features <sup>3,4</sup>	✓	✓	✓	✓	✓	✓
1.9.1 Setting the Alarm (Timed Reminder)	✓		✓	✓	✓	
1.9.2 Refusing Incoming Calls (Do Not Disturb [DND])						
◆◆ Do Not Disturb (DND)	✓	✓	✓	✓	✓	✓
◆◆ Switching FWD/DND Status Using Fixed FWD/DND Button	✓			✓ <sup>2</sup>		
1.9.3 Receiving Call Waiting (Call Waiting/Off-hook Call Announcement [OHCA]/Whisper OHCA) <sup>5,6</sup>	✓	✓	✓	✓	✓	✓
1.9.4 Displaying Your Telephone Number on the Called Party and Caller's Telephone (Calling/Connected Line Identification Presentation [CLIP/ COLP])	✓	✓	✓	✓	✓	✓
1.9.5 Preventing Your Telephone Number Being Displayed on the Caller's Telephone (Connected Line Identification Restriction [COLR])	✓	✓	✓	✓	✓	✓
1.9.6 Preventing Your Number Being Displayed on the Called Party's Telephone (Calling Line Identification Restriction [CLIR])	✓	✓	✓	✓	✓	✓
1.9.7 Preventing Other People from Joining Your Conversation (Executive Busy Override Deny)	✓	✓	✓	✓	✓	✓
1.9.8 Turning on the Background Music (BGM)	✓					
1.9.9 Protecting Your Line against Notification Tones (Data Line Security)	✓	✓	✓	✓	✓	
1.9.10 Checking the Time Service Status	✓					
1.9.11 Setting the Paralleled Telephone to Ring (Paralleled Telephone)	✓ <sup>7</sup>					
1.9.12 Using Your PS or S-PS in Parallel with a Wired Telephone (Wireless XDP Parallel Mode)		✓				✓
1.9.13 Using Your phone in Parallel with a Wired Telephone (One-numbered extension)	✓		✓	✓	✓	
1.9.14 Clearing Features Set at Your Extension (Extension Feature Clear)	✓	✓	✓	✓	✓	✓
1.10.1 Leaving an Incoming Call Distribution Group (Log-in/Log-out, Wrap-up)	✓	✓	✓	✓	✓	✓

## 5.1.1 List of Operations by Telephone Type

Features	Telephone Type					
	PT	PS	SLT	SIP phone		S-PS
				KX-UT series	Non-KX-UT series	
1.10.2 Monitoring and Controlling the Call Status of an Incoming Call Distribution Group (Incoming Call Distribution Group Monitor)						
◆◆ Monitoring the Status of Waiting Calls	✓ <sup>8</sup>					
◆◆ Monitoring and Changing the Log-in/Log-out Status of Extensions	✓ <sup>8</sup>					
1.10.3 Forwarding a Waiting Call (Manual Queue Redirection)	✓	✓				
1.11.1 If a Doorphone/Door Opener is Connected						
◆◆ Doorphone Call	✓	✓	✓	✓	✓	✓
◆◆ Opening a Door (Door Open)	✓	✓	✓	✓	✓	✓
1.11.2 If an External Relay is Connected						
To switch on the relay	✓	✓	✓			
1.11.3 If an External Sensor is Connected						
To answer a sensor call	✓	✓	✓	✓	✓	✓
1.11.4 If a Host PBX is Connected						
◆◆ Accessing External Services (External Feature Access [EFA])	✓	✓	✓	✓		✓
1.11.5 If a Voice Processing System is Connected						
◆◆ Call Forwarding to Voice Mail (Voice Mail Integration)	✓	✓	✓			
◆◆ Screening Calls (Live Call Screening [LCS])	✓	✓				
◆◆ Recording a Conversation	✓	✓				
1.12.1 Using the Telephones in a Hotel-type Environment (Hospitality Features)						
◆◆ Check-in	✓ <sup>8</sup>					
◆◆ Check-out	✓ <sup>8</sup>					
◆◆ Setting a Timed Reminder to a Room Extension (Remote Wake-up Call)	✓					
◆◆ Cleaned-up	✓ <sup>8</sup>					
1.12.2 Recording Information Using Preprogrammed Messages (Printing Message)	✓		✓			

### 5.1.1 List of Operations by Telephone Type

Features	Telephone Type					
	PT	PS	SLT	SIP phone		S-PS
				KX-UT series	Non-KX-UT series	
1.13.1 Walking Extension	✓		✓			
1.13.2 Enhanced Walking Extension	✓		✓			
1.14.1 Using the Call Log	✓	✓		✓		✓
1.14.2 Using the Directories	✓	✓				
1.14.3 Accessing System Features (System Feature Access)	✓ <sup>*9</sup>			✓		
1.14.4 Self Labelling (KX-NT366/KX-NT553/KX-NT556/KX-NT560/KX-UT248/KX-UT670 only)	✓ <sup>*10</sup>			✓ <sup>*11</sup>		
2.1.1 Extension Control	✓	✓	✓	✓	✓	✓
2.1.2 Time Service Mode Control	✓	✓	✓	✓	✓	✓
2.1.3 Restriction Level Control (Dial Tone Transfer)	✓	✓				
2.1.4 Turning on the External Background Music (BGM)	✓	✓	✓	✓	✓	✓
2.1.5 Recording Outgoing Messages (OGM)	✓					
2.1.6 Allowing Users to Seize an Unavailable Outside Line (Trunk Busy Out)	✓	✓	✓			
2.1.7 Releasing Network Direct Station Selection (NDSS) Monitor	✓	✓				
2.2 Configuring Unified Messaging Features <sup>*12</sup>	✓	✓	✓	✓	✓	✓
3.1 Customising Your Phone (Personal Programming)						
◆◆ Assigning an Extension PIN to Your Extension (Extension PIN [Personal Identification Number])	✓	✓	✓	✓	✓	✓
3.1.2 Settings on the Programming Mode	✓	✓				
3.1.3 Customising the Buttons	✓	✓				
4.1 Manager Programming						

### 5.1.1 List of Operations by Telephone Type

Features	Telephone Type					
	PT	PS	SLT	SIP phone		S-PS
				KX-UT series	Non-KX-UT series	
◆◆ Changing Call Charges and Extension Control	✓					

\*1 Only available for the KX-UT133, KX-UT136, KX-UT248, and KX-UT670.

\*2 Not available for the KX-UT670.

\*3 "◆◆ Live Call Screening (LCS)" and "◆◆ Recording Your Conversation" are only available for PTs and PSs.

\*4 "◆◆ Setting the Alarm (Timed Reminder)" is only available for PTs, SLTs and SIP phones.

\*5 OHCA is only available for certain DPTs.

\*6 Whisper OHCA is only available for IP-PTs and certain DPTs.

\*7 Only available for DPTs.

\*8 Only available for Display PTs.

\*9 Only available for the KX-NT300 series, KX-NT500 series (except KX-NT511), KX-DT300 series, KX-DT500 series, and KX-T7600 series.

\*10 Only available for the KX-NT366 and KX-NT553/KX-NT556/KX-NT560.

\*11 Only available for the KX-UT248 and KX-UT670.

\*12 "◆◆ Setting the Timed Reminder" is only available for PTs, SLTs and SIP phones.

## 5.2 Troubleshooting

### 5.2.1 Troubleshooting

#### ◆◆ Troubleshooting

Problem	Remedy
The telephone does not work properly.	<ul style="list-style-type: none"> <li>➡ Confirm with your manager that your settings are correct.</li> <li>➡ If the problem persists, consult your dealer.</li> </ul>
The telephone does not respond when buttons are pressed.	<ul style="list-style-type: none"> <li>• <b>The telephone is locked.</b> ➡ Unlock your telephone. (👉 1.6.3 Preventing Other People from Using Your Telephone (Extension Dial Lock), 2.1.1 Extension Control)</li> </ul>
Some features do not work.	<ul style="list-style-type: none"> <li>• <b>System management may restrict certain features.</b> ➡ Consult your manager.</li> <li>• <b>The feature numbers have changed.</b> ➡ Confirm the revised number and try again.</li> </ul>
Even though following the manual instructions, none of the operations work when using a proprietary telephone.	<ul style="list-style-type: none"> <li>• <b>The Intercom line was not seized.</b> The seized line, when going off-hook, was changed by personal setting. (👉 3.1.2 Settings on the Programming Mode) ➡ In the manual, going off-hook means an Intercom line is seized. If the setting has been changed, press the INTERCOM or PDN button after going off-hook and follow the instructions.</li> </ul>
The paralleled single line telephones do not ring.	<ul style="list-style-type: none"> <li>• <b>"No ring" may be selected.</b> Change the setting to ring. (👉 1.9.11 Setting the Paralleled Telephone to Ring (Paralleled Telephone))</li> </ul>
My proprietary telephone does not have a feature button.	<ul style="list-style-type: none"> <li>• <b>Some models do not have the feature button.</b> ➡ Change a flexible button to the desired button. (👉 3.1.3 Customising the Buttons) ➡ Enter the specified feature number instead of the feature button. (👉 1.1.4 Before Operating the Telephones)</li> </ul>

Problem	Remedy
<p><b>A reorder tone is audible or "Restricted" is displayed.</b></p>	<ul style="list-style-type: none"> <li>• <b>The telephone is locked.</b>            ➔ Unlock your telephone.            (👉 1.6.3 Preventing Other People from Using Your Telephone (Extension Dial Lock), 2.1.1 Extension Control)</li> <li>• <b>Toll restriction is activated.</b>            ➔ Consult your manager or dealer.</li> <li>• <b>An account code is required.</b>            (👉 1.2.7 Calling without Restrictions, ♦♦ Using an Account Code (Account Code Entry) in 1.2.1 Basic Calling)</li> </ul>
<p><b>I cannot make an outside call using the One-touch Dialling button or speed dialling.</b></p>	<ul style="list-style-type: none"> <li>• <b>A line access number was not stored.</b>            ➔ A line access number is required for outside calls. (👉 1.2.1 Basic Calling, 3.1.3 Customising the Buttons)</li> </ul>
<p><b>I cannot remember the feature numbers.</b></p>	<ul style="list-style-type: none"> <li>• ➔ If the feature numbers have been changed from the default values, write the new feature numbers in the table in "5.3.1 Feature Number Table".</li> <li>• ➔ Ask your dealer to change the feature numbers for easier use.</li> </ul>
<p><b>While talking to an outside party, the line is disconnected.</b></p>	<ul style="list-style-type: none"> <li>• <b>The time limit has run out.</b>            (👉 1.4.1 Transferring a Call (Call Transfer), 1.4.5 Multiple Party Conversation)            ➔ Consult your dealer to extend the time limit, if necessary.</li> </ul>
<p><b>Redialling does not function.</b></p>	<ul style="list-style-type: none"> <li>• <b>The dialled number was more than 32 digits.</b> (👉 1.2.3 Redial)</li> </ul>
<p><b>I cannot have a conversation using the Bluetooth headset.</b></p>	<ul style="list-style-type: none"> <li>• ➔ Make sure that the headset is properly registered to the module.</li> <li>• ➔ Make sure that the headset is properly charged according to the manual of the headset.</li> <li>• ➔ Remove the wired headset from the headset jack. Priority is given to the wired headset when both are connected.</li> </ul>
<p><b>I cannot register, de-register, or confirm the ID of the Bluetooth headset.</b></p>	<ul style="list-style-type: none"> <li>• ➔ Make sure that the module is properly installed in the IP-PT/DPT.</li> </ul>
<p><b>The PC and fax machine communication failed.</b></p>	<ul style="list-style-type: none"> <li>• <b>An indication tone may have interrupted communication.</b> (👉 1.9.9 Protecting Your Line against Notification Tones (Data Line Security))</li> </ul>

## 5.2.1 Troubleshooting

Problem	Remedy
<p><b>I do not want to show my telephone number to the calling or called party's telephone.</b></p>	<ul style="list-style-type: none"> <li>• (👉 1.9.5 Preventing Your Telephone Number Being Displayed on the Caller's Telephone (Connected Line Identification Restriction [COLR]), 1.9.6 Preventing Your Number Being Displayed on the Called Party's Telephone (Calling Line Identification Restriction [CLIR]))</li> </ul>
<p><b>I want to show my telephone number to the calling or called party's telephone.</b></p>	<ul style="list-style-type: none"> <li>• (👉 1.9.4 Displaying Your Telephone Number on the Called Party and Caller's Telephone (Calling/Connected Line Identification Presentation [CLIP/COLP]).</li> </ul>
<p><b>I cannot send a call waiting tone to the dialled extension.</b></p>	<ul style="list-style-type: none"> <li>• <b>The other party has not set the Call Waiting feature.</b> (👉 ♦♦ Sending a Call Waiting Notification (Call Waiting), 1.4.4 Answering Call Waiting, 1.9.3 Receiving Call Waiting (Call Waiting/Off-hook Call Announcement [OHCA]/Whisper OHCA))</li> <li>• <b>The other party has set Data Line Security.</b> (👉 1.9.9 Protecting Your Line against Notification Tones (Data Line Security))</li> </ul>
<p><b>I forgot the password.</b></p>	<ul style="list-style-type: none"> <li>• Ask the manager to assist you. (👉 2.1.1 Extension Control)</li> </ul>
<p><b>The background music started suddenly.</b></p>	<ul style="list-style-type: none"> <li>• ➡ Turn off the music. (👉 1.9.8 Turning on the Background Music (BGM), 2.1.4 Turning on the External Background Music (BGM))</li> </ul>
<p><b>I do not want to display a number which is stored in memory.</b></p>	<ul style="list-style-type: none"> <li>• ➡ Conceal the number. (👉 ♦♦ Storing Names and Numbers, 3.1.3 Customising the Buttons)</li> </ul>
<p><b>I want to confirm my extension number.</b></p>	<ul style="list-style-type: none"> <li>• (👉 Your Extension Number in 1.1.4 Before Operating the Telephones)</li> </ul>
<p><b>The date and time are not correct.</b></p>	<ul style="list-style-type: none"> <li>• <b>Set the date and time by system programming.</b> ➡ Consult your dealer.</li> </ul>
<p><b>The visibility of the display is poor.</b></p>	<ul style="list-style-type: none"> <li>• ➡ Change the Display contrast level. (👉 3.1.2 Settings on the Programming Mode)</li> </ul>
<p><b>I want to specify the ringing tones.</b></p>	<ul style="list-style-type: none"> <li>• (👉 To specify the ringing tones for each CO, ICD Group, PDN, SDN, or INTERCOM button (DPT/IP-PT only), 3.1.3 Customising the Buttons)</li> </ul>



Problem	Remedy
The MESSAGE button light has lit up.	<ul style="list-style-type: none"> <li>• <b>Another extension left you a message waiting indication or someone left a message in your mailbox while you were on the phone or away from your desk.</b></li> </ul>
An SDN button on my extension does not work.	<ul style="list-style-type: none"> <li>• <b>A PDN button is not assigned on the extension corresponding to your SDN button.</b>  <ul style="list-style-type: none"> <li>➔ Create a PDN button on the desired extension. (👉 3.1.3 Customising the Buttons)</li> </ul> </li> </ul>
I cannot use the secondary Ethernet port.	<ul style="list-style-type: none"> <li>• ➔ If you are using a KX-NT500 series telephone, check whether ECO mode is enabled (👉 📄 Display in 1.1.4 Before Operating the Telephones). If it is enabled, ask your dealer to disable ECO mode. For other types of IP-PTs, contact your dealer.</li> </ul>

## 5.3 Feature Number Table

### 5.3.1 Feature Number Table

Numbers listed below are the default settings. There are flexible feature numbers and fixed feature numbers. If you change the flexible feature numbers, fill in your assigned numbers (new) in the list for future reference.

Feature (While dial tone is heard)	Default (New)	Additional digits/buttons
<b>1.2.1 Basic Calling</b> To call an operator (Operator Call)	9/0 (      )	
To select an idle outside line automatically (Automatic Line Access)	0/9 (      )	outside phone no.
To select an idle outside line in the specified outside line group automatically (Outside Line Group Access)	8 (      )	outside line group no. (2 digits) + outside phone no.
◆◆ Making a Call to a Private Network (TIE Line Access)	7 (      )	private phone no.
◆◆ Using an Account Code (Account Code Entry)	*49 (      )	account code + # + outside phone no.
<b>1.2.2 Easy Dialling</b> ◆◆ Using Numbers Stored at Your Extension (Personal Speed Dialling)		
– To store	*30 (      )	personal speed dialling no. (2 digits) + phone no. + #
– To dial	** (      )	* + personal speed dialling no. (2 digits)
◆◆ Using Numbers Stored in the PBX (System Speed Dialling)		
– To dial	** (      )	system speed dialling no. (3 digits)
◆◆ To a Preset Number by Going Off-hook (Hot Line)	*740 (      )	
– To store		2 + phone no. + #
– To set		1
– To cancel		0
<b>1.2.3 Redial</b> ◆◆ Redialling the Last Number You Dialed (Last Number Redial)	# (      )	

Feature (While dial tone is heard)	Default (New)	Additional digits/buttons
<p>1.2.4 When the Dialed Line is Busy or There is No Answer</p> <p>To cancel callback ringing (Automatic Callback Busy Cancel)/To cancel (CCBS Cancel)</p> <p>◆◆ Leaving a Message Waiting Indication/Calling Back the Caller Who Left an Indication (Message Waiting)</p> <p>For an extension leaving a message waiting indication</p> <ul style="list-style-type: none"> <li>– To leave/cancel</li> </ul> <p>For an extension receiving a message waiting indication</p> <ul style="list-style-type: none"> <li>– To call back</li> <li>– To clear</li> </ul>	<p style="text-align: center;">*46 (        )</p> <p style="text-align: center;">*70 (        )</p>	<p>1/0 + extension no.</p> <p>2</p> <p>0 + your extension no.</p>
<p>1.2.7 Calling without Restrictions</p> <p>◆◆ Using Your Calling Privileges at Another Extension (Remote COS Access)</p> <p>To call with a verification code (Verification Code Entry)</p>	<p style="text-align: center;">*47 (        )</p>	<p>extension no. + extension PIN + phone no.</p> <p>* + verification code + verification code PIN + phone no.</p>
<p>1.2.8 To Access Another Party Directly from Outside (Direct Inward System Access [DISA])</p> <p>◆◆ Calling through DISA</p> <ul style="list-style-type: none"> <li>– To an extension (In All Security Mode only)</li> <li>– To an outside party (In Trunk Security Mode/All Security Mode only)</li> </ul>		<p>your extension no./( * + verification code ) + extension PIN/verification code PIN + extension no.</p> <p>your extension no./( * + verification code ) + extension PIN/verification code PIN + outside phone no.</p>
<p>1.2.9 Setting Your Telephone from Another Extension or through DISA (Remote Setting)</p> <ul style="list-style-type: none"> <li>– From another extension</li> <li>– Through DISA</li> </ul>		<p>your extension no. + extension PIN + feature no.</p>
<p>1.3.3 Answering a Call Ringing at Another Telephone (Call Pickup)</p> <p>◆◆ Answering a Call from Another Telephone (Call Pickup)</p>		

### 5.3.1 Feature Number Table

Feature (While dial tone is heard)	Default (New)	Additional digits/buttons
<ul style="list-style-type: none"> <li>– Group</li> <li>– Directed</li> <li>◆◆ Denying Other People the Possibility of Picking Up Your Calls (Call Pickup Deny) <ul style="list-style-type: none"> <li>– To deny</li> <li>– To allow</li> </ul> </li> </ul>	<p>✖40 (        )</p> <p>✖41 (        )</p> <p>✖720 (        )</p>	<p>group no. (2 digits)</p> <p>extension no.</p> <p>1</p> <p>0</p>
<p>1.3.4 Answering a Call via an External Speaker (Trunk Answer From Any Station [TAFAS])</p> <ul style="list-style-type: none"> <li>– Calls through an external speaker</li> </ul>	<p>✖42</p>	<p>external pager no.</p>
<p>1.3.6 Identifying Malicious Calling Parties (Malicious Call Identification [MCID])</p>	<p>✖7✖3 (        )</p>	
<p>1.4.1 Transferring a Call (Call Transfer)</p> <ul style="list-style-type: none"> <li>◆◆ Transferring a Call Using the ISDN Service (Call Transfer [CT]—by ISDN)</li> <li>◆◆ Transferring to an Outside Party Using the SIP Service <ul style="list-style-type: none"> <li>– Blind Transfer</li> </ul> </li> </ul>	<p>✖62 (        )</p> <p>✖61 (        )</p>	<p>phone no.</p> <p>phone no. + #</p>
<p>1.4.2 Holding a Call</p> <p>To hold (Call Hold)/To retrieve a call (Call Hold Retrieve)</p> <p>To retrieve a call (Call Hold Retrieve)</p> <ul style="list-style-type: none"> <li>– Specified with a held line number</li> <li>– Specified with a holding extension number</li> <li>◆◆ Holding in a System Parking Zone (Call Park) <ul style="list-style-type: none"> <li>– To set</li> <li>– To retrieve</li> </ul> </li> </ul>	<p>✖50 (        )</p> <p>✖53 (        )</p> <p>✖51 (        )</p> <p>✖52 (        )</p>	<p>outside line no. which is held (3 digits)</p> <p>extension no. which has a held call</p> <p>parking zone no. (2 digits)/✖</p> <p>stored parking zone no. (2 digits)</p>
<p>1.4.4 Answering Call Waiting</p> <ul style="list-style-type: none"> <li>◆◆ Answering Call Waiting in the PBX</li> </ul>	<p>✖50 (        )</p>	

Feature (While dial tone is heard)	Default (New)	Additional digits/buttons
◆◆ Answering Call Waiting from the Telephone Company	*60 (        )	
1.4.5 Multiple Party Conversation ◆◆ Adding a Third Party during a Conversation Using the ISDN Service (Three-party Conference [3PTY]—by ISDN)	*62 (        )	phone no. + TRANSFER button + 3
1.6.1 Forwarding Calls ◆◆ Forwarding Your Calls (Call Forwarding [FWD])/ 1.9.2 Refusing Incoming Calls (Do Not Disturb [DND])		
– Both Calls	*710 (        )	0 (Cancel)/ 1 (Do Not Disturb [DND])/ 2 (All calls) + phone no. + #/ 3 (Busy) + phone no. + #/ 4 (No Answer) + phone no. + #/ 5 (Busy/No Answer) + phone no. + #/ 7 (Follow Me) + your extension no./ 8 (Follow Me Cancel) + your extension no.
– Outside Calls	*711 (        )	
– Intercom Calls	*712 (        )	
– To set the timer for "No Answer" and "Busy/No Answer"	*713 (        )	00–99 (second)
To set/cancel (Call Forwarding [FWD] for your Incoming Call Distribution Group)		
– Both Calls	*714 (        )	
– Outside Calls	*715 (        )	1 (Set) + ICD Group extension no. + phone no. + #/ 0 (Cancel) + ICD Group extension no.
– Intercom Calls	*716 (        )	
◆◆ Forwarding Your Calls Using ISDN Service (Call Forwarding [CF]—by ISDN)	*7*5 (        )	
– To set		outside line no. + # + multiple subscriber no. + # + 2 (Unconditional)/3 (Busy)/4 (No Reply) + phone no. + #
– To cancel		outside line no. + # + multiple subscriber no. + # + 0
– To confirm		outside line no. + # + multiple subscriber no. + # + 1

### 5.3.1 Feature Number Table

Feature (While dial tone is heard)	Default (New)	Additional digits/buttons
<p>1.6.2 Showing a Message on the Caller's Telephone Display (Absent Message)</p> <ul style="list-style-type: none"> <li>– To set</li> <li>– To cancel</li> </ul>	<p>×750 (        )</p>	<p>1–9 (+ parameter) + # 0</p>
<p>1.6.3 Preventing Other People from Using Your Telephone (Extension Dial Lock)</p> <ul style="list-style-type: none"> <li>– To lock</li> <li>– To unlock</li> <li>– To make an outside call while your extension is locked</li> </ul>	<p>×77 (        )</p> <p>×47 (        )</p>	<p>1 0 + extension PIN your extension no. + extension PIN + phone no.</p>
<p>1.6.4 Using Voice Messaging (Built-in Simplified Voice Message [SVM])</p> <p>◆◆ Recording a Normal Greeting Message</p> <ul style="list-style-type: none"> <li>– To record</li> <li>– To play back</li> <li>– To clear</li> </ul> <p>◆◆ Recording a Greeting Message for Each Time Mode</p> <ul style="list-style-type: none"> <li>– To record</li> <li>– To play back</li> <li>– To clear</li> </ul> <p>To leave a voice message directly to another extension's message box</p> <p>◆◆ Listening to Voice Messages Left by Callers</p> <p>◆◆ Redirecting Your Calls to Your Message Box</p> <ul style="list-style-type: none"> <li>– Both Calls</li> <li>– Outside Calls</li> </ul>	<p>×38 (        )</p> <p>×710 (        )</p> <p>×711 (        )</p>	<p>1 2 0 8 + 0 (Day)/1 (Night)/2 (Lunch)/3 (Break) + 1 8 + 0 (Day)/1 (Night)/2 (Lunch)/3 (Break) + 2 8 + 0 (Day)/1 (Night)/2 (Lunch)/3 (Break) + 0 # + 6 + extension no. 3 0 (Cancel)/ 2 (All Calls) + floating extension no. for the SVM feature<sup>7</sup> + #/</p>

Feature (While dial tone is heard)	Default (New)	Additional digits/buttons
– Intercom Calls	*712 (        )	3 (Busy) + floating extension no. for the SVM feature <sup>7</sup> + #/ 4 (No Answer) + floating extension no. for the SVM feature <sup>7</sup> + #/ 5 (Busy/No Answer) + floating extension no. for the SVM feature <sup>7</sup> + #
1.7.1 Paging ◆◆ Group Paging	*33 (        )	paging group no. (2 digits)
1.7.2 Answering/Denying a Paging Announcement – To answer – To deny – To allow	*43 (        )  *721 (        )	  1  0
1.7.3 Making a Conference Group Call – To call and start a conversation – To call and make an announcement ◆◆ Join After Time Out – To make a conference group call with an entry code – To join a conversation with an entry code	*32 (        )	conference group no. (1 digit) + entry code + # conference group no. (1 digit) + entry code + #  conference group no. (1 digit) + entry code + # # + conference group no. (1 digit) + entry code + #
1.8.5 Transferring Calls ◆◆ Voice Mail Transfer – Both Calls – Outside Calls – Intercom Calls	*710 (        )  *711 (        )  *712 (        )	0 (Cancel)/ 2 (All calls)/ 3 (Busy)/ 4 (No Answer)/ 5 (Busy/No Answer) + UM group's floating extension no. <sup>1</sup> + #
1.9.1 Setting the Alarm (Timed Reminder) – To set  – To cancel	*760 (        )	12H: 1 + hour/minute + 0 (AM)/1 (PM) + 0 (once)/1 (daily) 24H: 1 + hour/minute + 0 (once)/1 (daily)  0

### 5.3.1 Feature Number Table

Feature (While dial tone is heard)	Default (New)	Additional digits/buttons
1.9.3 Receiving Call Waiting (Call Waiting/Off-hook Call Announcement [OHCA]/Whisper OHCA) <ul style="list-style-type: none"> <li>– For intercom calls (No call/Tone/OHCA/Whisper OHCA)</li> <li>– For outside calls (No tone/Tone)</li> </ul>	*731 (        )	0 (No call)/1 (Tone)/2 (OHCA)/3 (Whisper OHCA)
1.9.4 Displaying Your Telephone Number on the Called Party and Caller's Telephone (Calling/Connected Line Identification Presentation [CLIP/ COLP]) <ul style="list-style-type: none"> <li>– Public</li> <li>– Your extension</li> </ul>	*7*2 (        )	1 2
1.9.5 Preventing Your Telephone Number Being Displayed on the Caller's Telephone (Connected Line Identification Restriction [COLR]) <ul style="list-style-type: none"> <li>– To show</li> <li>– To prevent</li> </ul>	*7*0 (        )	0 1
1.9.6 Preventing Your Number Being Displayed on the Called Party's Telephone (Calling Line Identification Restriction [CLIR]) <ul style="list-style-type: none"> <li>– To show</li> <li>– To prevent</li> </ul>	*7*1 (        )	0 1
1.9.7 Preventing Other People from Joining Your Conversation (Executive Busy Override Deny) <ul style="list-style-type: none"> <li>– To prevent</li> <li>– To allow</li> </ul>	*733 (        )	1 0
1.9.8 Turning on the Background Music (BGM) <ul style="list-style-type: none"> <li>– To set</li> <li>– To cancel</li> </ul>	*751 (        )	BGM no. (1 digit) 0
1.9.9 Protecting Your Line against Notification Tones (Data Line Security) <ul style="list-style-type: none"> <li>– To set</li> <li>– To cancel</li> </ul>	*730 (        )	1 0



Feature (While dial tone is heard)	Default (New)	Additional digits/buttons
1.9.11 Setting the Paralleled Telephone to Ring (Paralleled Telephone) – Ring – No Ring	*39 ( )	1 0
1.9.12 Using Your PS or S-PS in Parallel with a Wired Telephone (Wireless XDP Parallel Mode) – To set – To cancel	*48 ( )	1 + paired wired extension no. 0
1.9.13 Using Your phone in Parallel with a Wired Telephone (One-numbered extension) – To set – To cancel To pickup the call	*48 ( )  *41 ( )	1 + paired wired extension no. 0 paired wired extension no.
1.9.14 Clearing Features Set at Your Extension (Extension Feature Clear)	*790 ( )	
1.10.1 Leaving an Incoming Call Distribution Group (Log-in/Log-out, Wrap-up) Log-in Log-out To enter/leave Not Ready mode	*736 ( )  *735 ( )	1 + ICD Group extension no./* 0 + ICD Group extension no./* 1 (Not Ready)/0 (Ready)
*4 1.10.2 Monitoring and Controlling the Call Status of an Incoming Call Distribution Group (Incoming Call Distribution Group Monitor)	*739 ( )	ICD Group extension no.
1.11.1 If a Doorphone/Door Opener is Connected ◆◆ Doorphone Call ◆◆ Opening a Door (Door Open)	*31 ( )  *55 ( )	doorphone no. (2 digits) doorphone no. (2 digits)
1.11.2 If an External Relay is Connected	*56 ( )	relay no. (2 digits)
1.11.4 If a Host PBX is Connected		

### 5.3.1 Feature Number Table

Feature (While dial tone is heard)	Default (New)	Additional digits/buttons
◆◆ Accessing External Services (External Feature Access [EFA])	*60 ( )	service code
1.11.5 If a Voice Processing System is Connected ◆◆ Call Forwarding to Voice Mail (Voice Mail Integration) – Both Calls – Outside Calls – Intercom Calls	*710 ( ) *711 ( ) *712 ( )	0 (Cancel)/ 2 (All Calls)/ 3 (Busy)/ 4 (No Answer)/ 5 (Busy/No Answer) + voice mail floating extension no. + #
1.12.1 Using the Telephones in a Hotel-type Environment (Hospitality Features) <sup>*5</sup> ◆◆ Setting a Timed Reminder to a Room Extension (Remote Wake-up Call) – To set  – To cancel – To confirm	*76* ( )	12H: 1 + extension no. + hour/minute + 0 (AM)/1 (PM) + 0 (once)/1 (daily) 24H: 1 + extension no. + hour/minute + 0 (once)/1 (daily)  0 + extension no. 2 + extension no.
1.12.2 Recording Information Using Preprogrammed Messages (Printing Message)	*761 ( )	message no. (+ parameter) + #
1.13.1 Walking Extension	*727 ( )	your extension no. + extension PIN
1.13.2 Enhanced Walking Extension – To set an extension status to Service-out – To set an extension status to Service-in	*727 ( )	#  * + your extension no. + extension PIN
2.1.1 Extension Control <sup>*2</sup> To lock/unlock other extensions (Remote Extension Dial Lock) – To unlock – To lock	*782 ( ) *783 ( )	extension no.  extension no.

Feature (While dial tone is heard)	Default (New)	Additional digits/buttons
<sup>*3</sup> 2.1.2 Time Service Mode Control – Day/Night/Lunch/Break	×780 ( )	0/1/2/3
<sup>*2</sup> 2.1.4 Turning on the External Background Music (BGM) – To start – To stop	×35 ( )	external pager no. + BGM no. (1 digit) × + BGM no. (1 digit) external pager no. + 0 × + 0
<sup>*2</sup> 2.1.5 Recording Outgoing Messages (OGM) – To record – To play back – To record from an external BGM (MOH) port – To clear	×36 ( )	1 + OGM floating extension no. <sup>*6</sup> 2 + OGM floating extension no. <sup>*6</sup> 3 + 1 + OGM floating extension no. <sup>*6</sup> 0 + OGM floating extension no. <sup>*6</sup>
<sup>*2</sup> 2.1.6 Allowing Users to Seize an Unavailable Outside Line (Trunk Busy Out)	×785 ( )	outside line no. (3 digits)
<sup>*2</sup> 2.1.7 Releasing Network Direct Station Selection (NDSS) Monitor	×784 ( )	another PBX extension no. + #
3.1.1 Customising Your Phone (Personal Programming) ◆◆ Assigning an Extension PIN to Your Extension (Extension PIN [Personal Identification Number]) – To set – To cancel	×799 ( )	1 + extension PIN + # + same extension PIN + # 0 + stored extension PIN

<sup>\*1</sup> The UM group's default floating extension number depends on system programming. For more information, consult your System Administrator or System Manager.

<sup>\*2</sup> Manager only

<sup>\*3</sup> Manager and preprogrammed extension user only

<sup>\*4</sup> Supervisor only

<sup>\*5</sup> Hotel operator only

<sup>\*6</sup> The default of OGM floating extension numbers depends on system programming. For more information, consult your System Administrator or System Manager.

<sup>\*7</sup> The default floating extension number for the SVM feature is 591.

### 5.3.1 Feature Number Table

<b>Feature (While busy, DND or call tone is heard/after dialling)</b>	<b>Default</b>
1.2.4 When the Dialed Line is Busy or There is No Answer	
◆◆ Sending a Call Waiting Notification (Call Waiting)	1
◆◆ To an Extension Refusing the Call (DND Override)	
◆◆ Joining an Existing Call (Executive Busy Override)	3
◆◆ Leaving a Message Waiting Indication/Calling Back the Caller Who Left an Indication (Message Waiting)	4
◆◆ Monitoring Another Extension (Call Monitor)	5
◆◆ Reserving a Busy Line (Automatic Callback Busy)/◆◆ Setting Callback on an ISDN Line (Completion of Calls to Busy Subscriber [CCBS])	6
1.2.6 Alternating the Calling Method (Alternate Calling—Ring/Voice)	*

<b>Feature (While dialling or talking)</b>	<b>Fixed Number</b>
1.4.5 Multiple Party Conversation	
◆◆ Adding Other Parties during a Conversation (Conference)	3
1.11.1 If a Doorphone/Door Opener is Connected From any extension while talking to the doorphone	5

## 5.4 What is This Tone?

### 5.4.1 What is This Tone?

#### While on-hook

##### Ring Tones

The following tones are programmable allowing recognition of call type (Outside, Intercom or Doorphone).

##### Tone 1



##### Tone 2

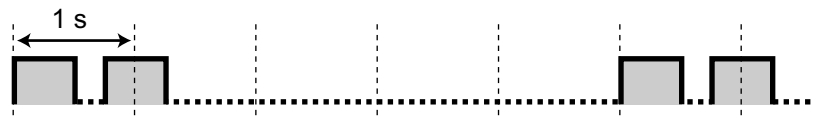

##### Tone 3

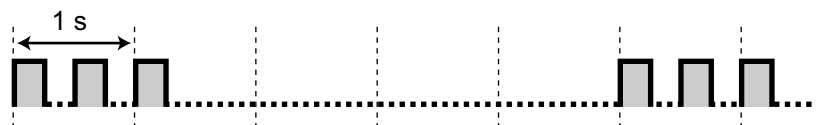

##### Tone 4

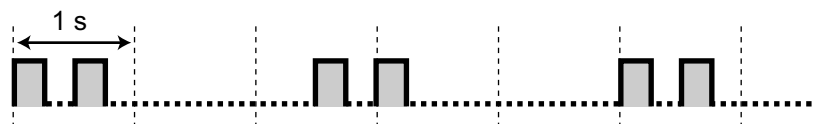

#### When going off-hook

##### Dial Tones

##### Tone 1

Normal

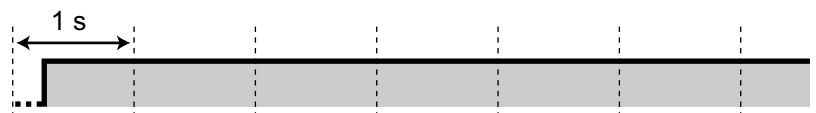

- For KX-UT series SIP phone and S-PS users: Tone 1 will be heard when any of the following features are set.
  - Absent Message
  - Call Pickup Deny
  - Call Waiting
  - Extension Dial Lock
  - Executive Busy Override Deny

### 5.4.1 What is This Tone?

#### Tone 2

- When there are messages that have previously been listened to and no new messages recorded by the SVM feature.
- When any of the following features are set:
  - Absent Message
  - Background Music
  - Call Forwarding
  - Call Pickup Deny
  - Call Waiting
  - Do Not Disturb
  - Extension Dial Lock
  - Executive Busy Override Deny
  - Hot Line
  - Timed Reminder
- For KX-UT series SIP phone users: Tone 2 will be heard when any of the following features are set.
  - Display Lock
- For KX-UT series SIP phone and S-PS users: Tone 2 will be heard when any of the following features are set.
  - Call Forwarding
  - Do Not Disturb

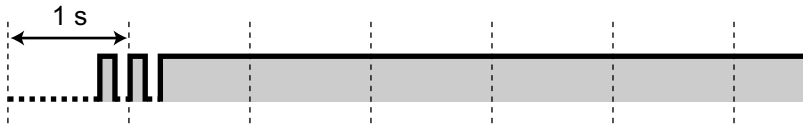

#### Tone 3

- When answering an external sensor call



(Not available for KX-UT series SIP phones and S-PSs)

- After pressing TRANSFER or Recall/hookswitch to hold a call temporarily (e.g., Call Splitting)
- While a called PS is being searched
- When Account Code Entry is performed
- When answering a Timed Reminder call with no message

#### Tone 4

Message waiting indication was received.

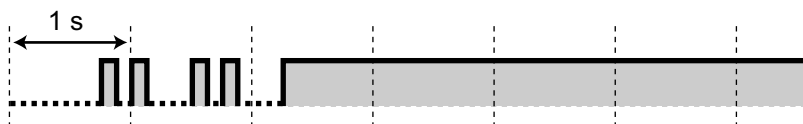

## When you make calls

### Busy Tone

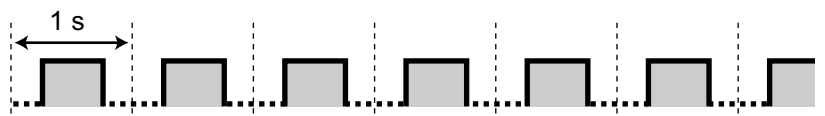

### Reorder Tone

The outside line you tried to seize is not assigned or denied.



### Ringback Tones

#### Tone 1

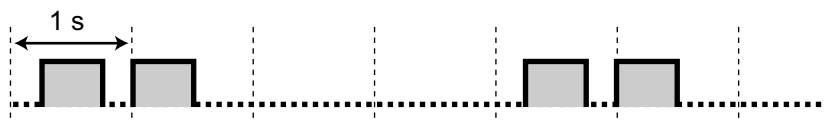

#### Tone 2

(Not available for KX-UT series SIP phones and S-PSs)

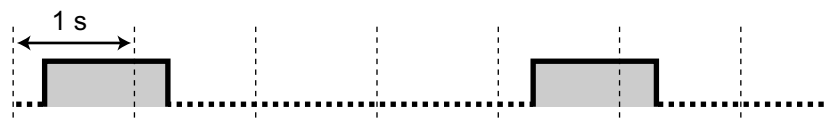

### Do Not Disturb (DND) Tone

(Not available for KX-UT series SIP phones and S-PSs)  
The dialed extension is refusing incoming calls.

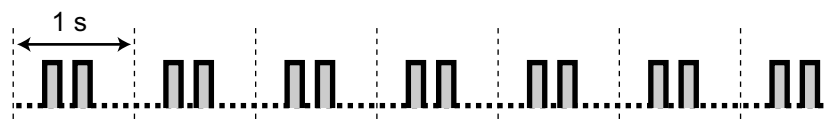

## While off-hook

### Indication Tones

#### Tone 1

Call waiting tone

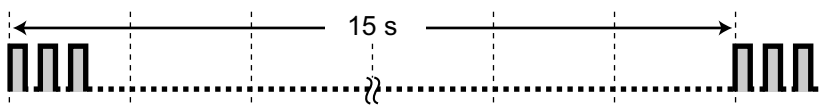

#### Tone 2

A call is on hold longer than the specified time

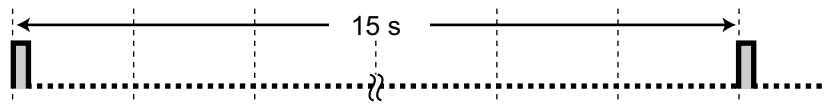

## When talking to an outside party

### Warning Tone

This tone is sent 15, 10 and 5 seconds before the specified time for disconnection.

For KX-UT series SIP phones and S-PSs, this tone is sent only once 15 seconds before the specified time for disconnection.

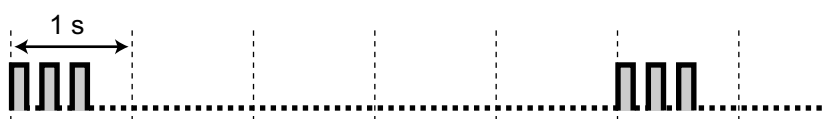

## When setting the features or programming

### Confirmation Tones

#### Tone 1

- The feature setting was set successfully.
- A call is received in Voice-calling mode.



#### Tone 2

- Before receiving a page through an external speaker
- You receive a call in Hands-free mode.
- You established a call with a KX-UT series SIP phone that has Hands-free Answerback enabled.



#### Tone 3

- Before the following features activate:
  - Retrieving a held call
  - Picking up another call
  - Paging/Answering a paging announcement
  - Answering the call through a speaker
- You establish a call with an extension in the following cases:
  - The called extension has hands-free Answerback enabled and is not a KX-UT series SIP phone.
  - Voice-calling mode
- When making a call to or from a doorphone.



#### Tone 4

Establishing or leaving a conference



#### Tone 5

A call has been put on hold.







**For Future Reference**

Please print, record, and retain the following information for future reference.

**Note**

The serial number of this product can be found on the label affixed to the unit. You should record the model number and the serial number of this unit as a permanent record of your purchase to aid in identification in the event of theft.

MODEL NO.	_____
SERIAL NO.	_____
DATE OF PURCHASE	_____
NAME OF DEALER	_____
DEALER'S ADDRESS	_____ _____ _____
DEALER'S TEL. NO.	_____

**Panasonic System Networks Co., Ltd.**

1-62, 4-chome, Minoshima, Hakata-ku, Fukuoka 812-8531, Japan

Web Site: <http://www.panasonic.net/>

**Copyright:**

This material is copyrighted by Panasonic System Networks Co., Ltd., and may be reproduced for internal use only. All other reproduction, in whole or in part, is prohibited without the written consent of Panasonic System Networks Co., Ltd.

© Panasonic System Networks Co., Ltd. 2014