

โปรเฟสชั่นแนล พี. เอ. บี. เอ็กซ์.  
30/270 ซอยนวมินทร์ 80 แขวงนวลจันทร์ เขตบึงกุ่ม กรุงเทพฯ 10230  
Hotline : 084-920-5065 Tel : 02-519-1718 , 02-107-3057  
E.Mail : info@pfbx.com , jirasak\_service@hotmail.com  
www.pfbx.com

# KX-NS300

## Basic Specification

PBX team

Jan 2016

# 1. One Page Sales Point

Enough capacity by IP !  
SIP for extension and trunk !



Digital Phone / SLT  
**Max.130**  
without D-XDP

IP Phone  
**Max.32**  
Additionally

No need to buy other PBX again  
to increase capacity in future

VoIP

Cost Saving

Business Improve

KX-NS  
300

DISA for Automated Attendant w/o operator !  
2-ch DISA Built-in !

AA

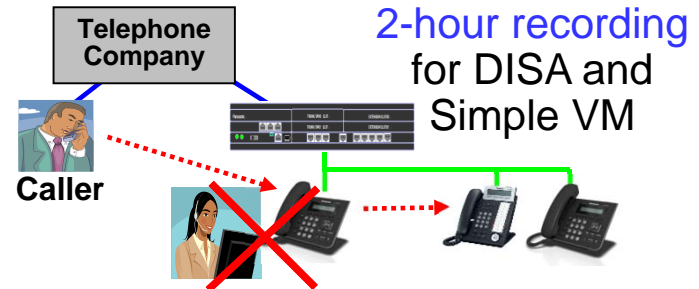

No need operator to transfer a call

Analog PT and old Digital PT connection when PBX replacement !

PT



No discard your PT

Cost Saving

Business Improve

VM, Recording and Call center feature by SD !

VM

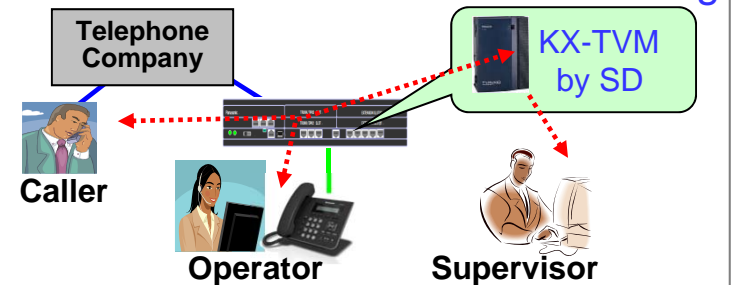

Supervisor can record a call.

## 2. Table of Contents

Chapter	Contents
1	Configuration 13 : One-look network by version 4.1 14 : BRI card by version 4.1 15 : PRI+LCOT6 for KX-NS320 by version 4.1 17 : Bigger D-XDP capacity by version 4.1.
2	Optional Card 21 : SLT Caller ID for DHLC4 by version 4.1
3	Activation Key
4	Built-in Solution

# 1. Main Cabinet

Cost Saving

You can save cost because required hardware is **factory pre-installed**.

- 2-ch DISA or Simple VM / **Recording time : 120 min**

(Simple VM specification is same as ESVM2 card on OPB3 card of KX-TDA100D.)

- Digital PT 2-port (+ 2 D-XDP)
- **SLT 16-port** with **caller ID** and **message waiting**
- **Analog CO 6-port** with **caller ID**

Analog CO can be changed to paging port or external BGM port.

- 2-ch internal BGM (WAV file can be saved.)
- LAN port (10/100 Base TX) / USB port
- Power supply / External battery port

RS232 is not supported.  
SMDR is available using LAN.

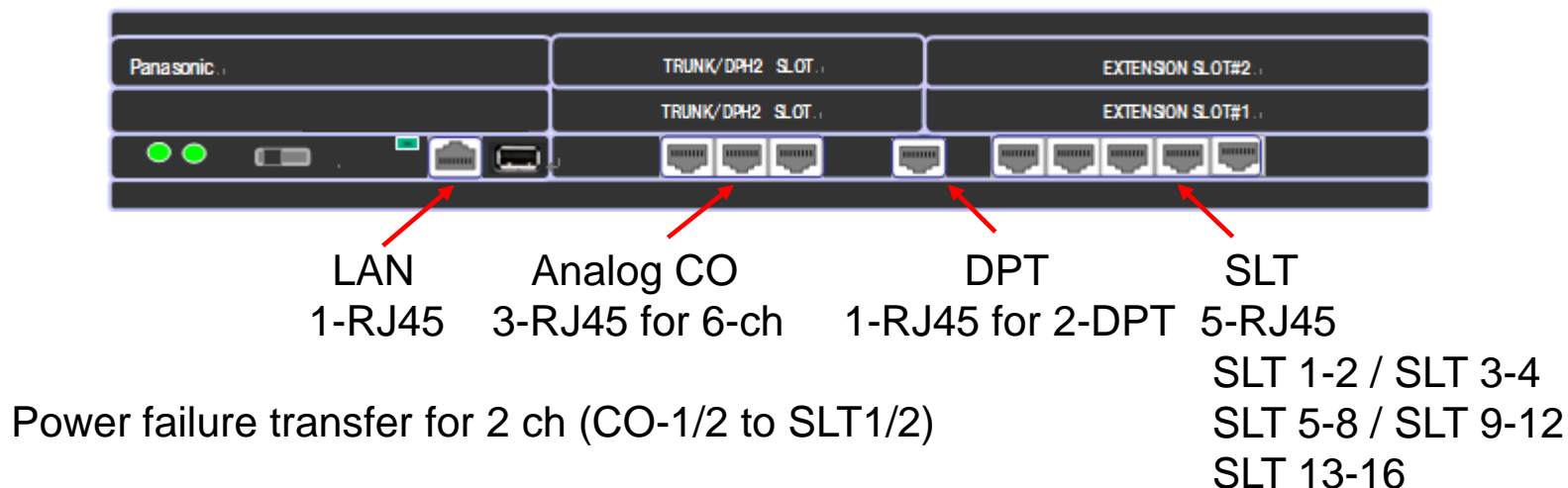

## 2. More Expandability

Cost Saving

Capacity can be increased to 1,000 extensions using KX-NS300 version 4.1 software with KX-NS1000. (Hardware of KX-NS300 version 4.1 is same as version 1.)

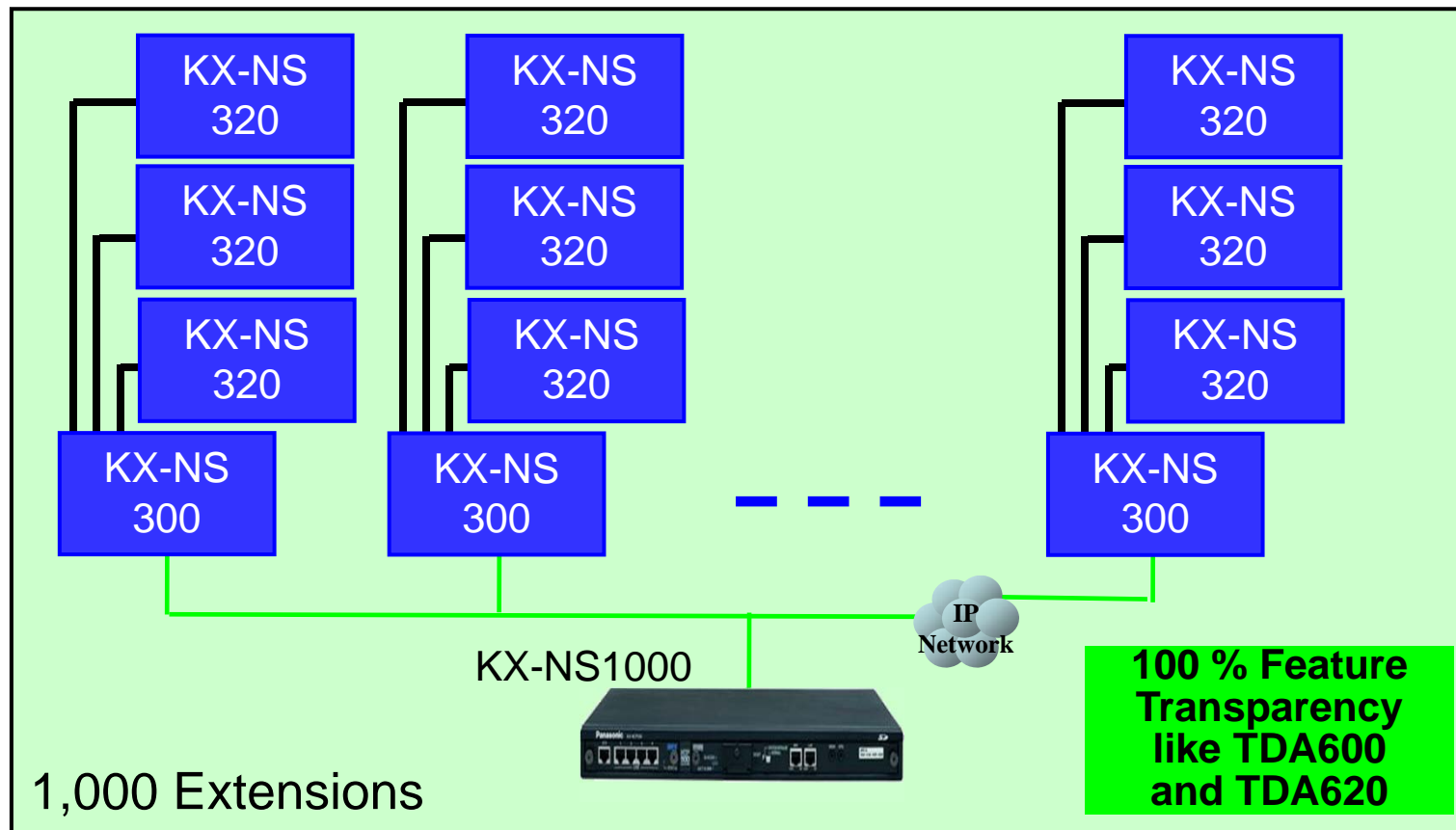

Max. 15 KX-NS300 with KX-NS320 can be slave unit of KX-NS1000.  
KX-NS1000 works as "KX-TDA600". KX-NS300 with KX-NS320 works as "KX-TDA620".

# 3. Card Installation for Main Cabinet

Each 2 free slots are supported for trunk and extension.

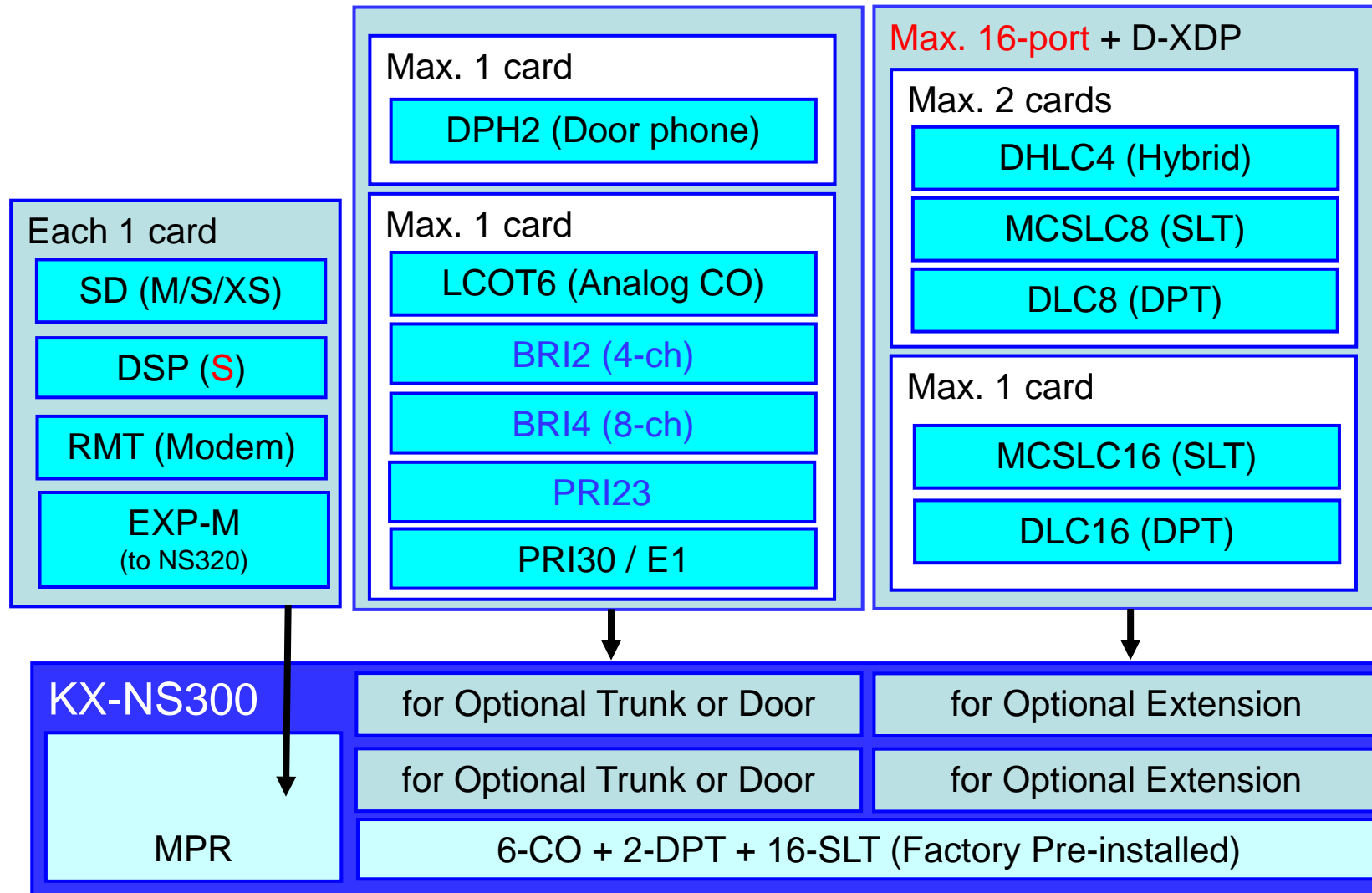

For example, if DLC16 is installed, other extension card cannot be installed.

# 4. Card Installation for Expansion Cabinet

Slot1 \ Slot2	LCOT6	BRI2 BRI4	PRI23 PRI30/E1	DPH2
LCOT6	Yes	Yes	Yes (V4.1)	Yes
BRI2 BRI4	Yes	Yes	No	Yes
PRI23 PRI30/E1	Yes (V4.1)	No	No	Yes
DPH2	Yes	Yes	Yes	No

Max. 16-port + D-XDP

Max. 2 cards

DHLC4 (Hybrid)

MCSLC8 (SLT)

DLC8 (DPT)

Max. 1 card

MCSLC16 (SLT)

DLC16 (DPT)

**KX-NS320**

Connection  
to KX-NS300  
(Factory pre-installed)

for Optional Trunk or Door

for Optional Trunk or Door

for Optional Extension

for Optional Extension

16-SLT (Factory Pre-installed)

## 5. Capacity for Trunk

Type	NS300 Pre-installed	NS300 Max.	NS300 + 1 NS320	NS300 + 2 NS320	NS300 + 3 NS320
Trunk (Legacy + IP)	6	52 (36+16)	88 (72+16)	124 (108+16)	160 (144+16)
Trunk (Legacy)	6	36 (30+6)	72 (V4.1) (36x2)	108 (V4.1) (36x3)	144 (V4.1) (36x4)
PRI30 / E1	0	30	60	90	120
BRI	0	8ch (BRI4x1)	24ch (8+8x2x1)	40ch (8+8x2x2)	56ch (8+8x2x3)
A+B+P	6	12	24	36	48
A. Analog CO	6	12	24	36	48
B. BGM	6	6	6	6	6
P. Paging	6	6	6	6	6
Trunk (IP)	0	16			
SIP	0	16			
H.323	0	16			

VoIP DSP card and [activation key](#) provide IP trunk for H.323 and SIP.



## 6. Capacity for Extension

Type	NS300 Pre-installed	NS300 Max.	NS300 + 1 NS320	NS300 + 2 NS320	NS300 + 3 NS320
Ext (Legacy + IP) without D-XDP	18 (18+0)	66 (34+32)	98 (66+32)	130 (98+32)	162 (130+32)
Extension (Legacy) without D-XDP	18 (16+2)	34 (32+2)	66 (64+2)	98 (96+2)	130 (128+2)
SLT	16	32	64	96	128
DTxx / T76xx without D-XDP	2	18 (16x1+2)	34 (16x2+2)	50 (16x3+2)	66 (16x4+2)
T74xx / T75xx / T77xx	0	8	16	24	32
Extension (IP)	0	32			

VoIP DSP card and activation key are required for IP extension.  
Extension capacity with D-XDP is limited by power supply capacity.

Max. is 128 DPT incl DXDP  
+ 64 SLT + 32 IP phone.

Model	Load Figure
KX-NS300	40
KX-NS320	40

Item	LF
Digital PT DTxxx / T76xxx	1
Digital PT by D-XDP	0.5
Analog PT	1.5
Digital PT I/F CS (2-ch)	2
Digital PT I/F CS (8-ch)	8

Item	LF
DHLC4	4
SLC8	8
SLC16	16
KX-NS300	16

For example,	
KX-NS300	16 LF
DLC16 x 1	0 LF
DT300 x 16	16 LF
D-XDP x 16	8 LF
32 DT+D-XDP	40 LF

Value of Load Figure is different from KX-TDA/TDE because KX-NS is new hardware design.

## 7. Capacity for Others

Type	NS300 Pre-installed	NS300 Max.	NS300 + 1 NS320	NS300 + 2 NS320	NS300 + 3 NS320
DISA	2ch	30ch by <b>DSP-S</b>			
Simple VM		2ch			
UM : Built-in TVM	0ch	24ch by <b>DSP + SD Card + Activation Key</b>			
KX-TVM (DPT I/F)	4ch	4ch + 24ch	48ch by 2 KX-TVM200		
Door phone / Opener / Sensor	0 / 0 / 0	2 / 2 / 2	4 / 4 / 4	6 / 6 / 6	8 / 8 / 8

## 8. Compatibility for Telephone

Cost Saving

PT	DHLC4	DLC8 / DLC16 2-ch digital port on main cabinet
KX-T70xx / KX-T71xx / KX-T73xx	No (*)	No for Analog PT
KX-T72xx (Load Figure : 2)		No for old Digital PT
KX-T74xx / T75xx (Load Figure : 2)	Yes	No for old Digital PT
KX-T77xx	Yes	No for Analog PT
KX-T76xx / KX-DT3xx / KX-DT5xx	Yes	Yes

<Compatible IP Phone>  
 KX-NT265  
 KX-NT3xx / KX-NT5xx  
 KX-UTxxx / KX-HDVxxx

<No Support>

KX-NT136 / KX-NT400 / KX-HGT100

KX-TDA0300 and KX-TDA0350 (Application for Digital PT using USB)

## 9. Optional Card for Extension / Trunk

Model	Symbol	Specification
KX-NS5170	DHLC4	4-port for KX-DT / Old Digital PT / Analog PT / CS (DPT I/F) / KX-TVM (DPT I/F) and 4-port SLT - DPT port : with XDP and Digital XDP - SLT port : with Caller ID (*1) but without MSW
KX-NS5171	DLC8	8-port for Digital PT : KX-T76xx / KX-DTxxx and CS (DPT I/F) / KX-TVM (DPT I/F)
KX-NS5172	DLC16	16-port for Digital PT : KX-T76xx / KX-DTxxx and CS (DPT I/F) / KX-TVM (DPT I/F)
KX-NS5173	MCSLC8	8-port SLT I/F with Caller ID and Message Waiting
KX-NS5174	MCSLC16	16-port SLT I/F with Caller ID and Message Waiting
KX-NS5180	LCOT6	6-port Analog Trunk I/F with Caller ID
KX-NS5282	BRI2	2-port x 2-ch ISDN
KX-NS5284	BRI4	4-port x 2-ch ISDN
KX-NS5290CE	PRI30/E1	30-ch ISDN or E1 by one card
KX-NS5162	DPH2	Each 2 I/F for Door phone / Opener / Sensor

T1, E&M and analog DID card are not supported.  
Pay tone feature is not available.

\*1) Should be V4.1 software and DHLC4 any hardware version.

## 10. Optional Card for Others

Model	Symbol	Specification
KX-NS5110	DSP-S	DISA (30 ch) or VoIP ( 61 ch) or mixture
KX-NS5162	DPH2	Each 2 I/F for Door phone / Opener / Sensor
KX-NS3134	SD(XS)	Built-in KX-TVM recording time : 40H 2G
KX-NS3135	SD(S)	Built-in KX-TVM recording time : 200H 8G
KX-NS3136	SD(M)	Built-in KX-TVM recording time : 400H 16G
KX-NS5130	EXP-M	Connection for KX-NS320 3 units
KX-TDA0196	RMT	Modem for remote maintenance

<SMDR>

40,000 calls are recorded with above any SD card.

1,000 calls are recorded without SD card.

# Activation Key

# 1. Activation Key : KX-NSF990

KX-NSF990	DSP	SD Card	VoIP	Built-in KX-TVM	DISA	Simple VM	SMDR (Calls)
--	No	No	N/A	N/A	2-ch		1,000
--	No	Yes	N/A	N/A	2-ch		40,000
No	Yes	No	N/A	N/A	30-ch	2-ch	1,000
No	Yes	Yes	N/A	N/A	30-ch	2-ch	40,000
Yes	Yes	No	Yes	N/A	30-ch	2-ch	1,000
Yes	Yes	Yes	Yes	Yes	30-ch	2-ch	40,000

KX-NS300 without KX-NSF990 is successor of KX-TDA.

KX-NS300 with KX-NSF990 is successor of KX-TDE and KX-NCP.



## 2. Activation Key for VoIP

KX-NSF990  
Required

### IP Trunk Activation Key as Trunk I/F Card

KX-NSM102	IP Trunk (SIP or H.323)	2 ch
KX-NSM104		4 ch
KX-NSM108		8 ch
KX-NSM116		16 ch

### IP Extension Activation Key as Extension I/F Card

KX-NSM201	Panasonic KX-NT based IP Software phone (and KX-NT/UT/ <b>HDV</b> hardware phone)		1 ch
KX-NSM205			5 ch
KX-NSM210			10 ch
KX-NSM220			20 ch
KX-NSM501	Panasonic KX-NT/UT/ <b>HDV</b> hardware phone (Not including Panasonic KX-NT700)		1 ch
KX-NSM505			5 ch
KX-NSM510			10 ch
KX-NSM520			20 ch
	<i>4-ch is pre installed.</i>		
KX-NSM701	SIP hardware/software phone (including Panasonic KX-NT700)		1 ch
KX-NSM705			5 ch
KX-NSM710			10 ch
KX-NSM720			20 ch

Activation keys in this page and following pages are for both KX-NS300 and KX-NS1000.



# 3. Activation Key for UM

KX-NSF990  
Required

## UM (Built-in KX-TVM) Activation Key

KX-NSU002	UM : Automatic Two-way Recording by supervisor	1 AK for All supervisors
KX-NSU003	UM : Message Backup	1 AK
KX-NSU102	UM : Channel Expansion as TVM204 card <i>2-ch is pre-installed.</i>	2 ch
KX-NSU104		4 ch
KX-NSU201	UM : E-mail	1 mailbox user
KX-NSU205		5 mailbox user
KX-NSU210		10 mailbox user
KX-NSU220		20 mailbox user
KX-NSU299		All mailbox user
KX-NSU301	UM : Two-way Recording by user	<b>1 extension user</b>
KX-NSU305		<b>5 extension user</b>
KX-NSU310		<b>10 extension user</b>
KX-NSU320		<b>20 extension user</b>
KX-NSU399		<b>All extension user</b>

<VoIP (AK for previous page)>  
DSP is also required.

<UM>  
SD card and DSP are also required.

## 4. Activation Key for PBX Features

### PBX Extension Feature Activation Key

KX-NSE101	Extension and Mobile parallel feature	1 extension user
KX-NSE105		5 extension user
KX-NSE110		10 extension user
KX-NSE120		20 extension user

### PBX to PBX Network Activation Key

KX-NSN001	One-look Network
KX-NSN002	QSIG Network with Enhance Feature

### System Feature Activation Key

KX-NSF101	3rd party CTI Interface
KX-NSA020	Multiple CTI Connection
KX-NSF201	Built-in web call center report Announcement of waiting order in queue

## 34. Activation Key for UC (Communication Assistant)

### CA Activation Key

KX-NSA201	CA Pro	1 extension user
KX-NSA205		5 extension user
KX-NSA210		10 extension user
KX-NSA240		40 extension user
KX-NSA249		128 extension user
KX-NSA301	CA Supervisor	1 extension user
KX-NSA401	CA Operator Console	1 extension user
KX-NSA901	CA Network Plug-in	1 CA user
KX-NSA905		5 CA user
KX-NSA910		10 CA user
KX-NSA940		40 CA user
KX-NSA949		128 CA user
KX-NSA010	CA Thin Client Server Connection	

## 5. Pre-Installed Activation Key

Following features are available **without buying activation key** and **without expiration**.

IP Extension for KX-NT/UT/HDV hardware phone : **4ch**

- Not for KX-NT700 and KX-NT based software phone
  - Not for 3<sup>rd</sup> party SIP phone
- => Easy to sell Panasonic KX-NT/UT/HDV

UM (Built-in KX-TVM) : 2 ch

KX-NSF990  
Required

CA Basic (Built-in server / External server) : All users

<VoIP>

DSP is also required.

<UM>

SD card and DSP are also required.

## 6. Pre-Installed Activation Key for Trial

60-day trial is available before buying activation key for followings.  
60-day can start anytime for each feature. (not start after default clear)  
Trial cannot be used repeatedly. (only one time)

UM (Built-in KX-TVM) : Automatic Two-way Recording by Supervisor
UM (Built-in KX-TVM) : Message Backup
UM (Built-in KX-TVM) : E-mail (128 mailbox users)
UM (Built-in KX-TVM) : 2 Way Recording (30 extension users)
Mobile Extension (30 extension users)
CA PRO (128 users)
CA Supervisor (1 user)
CA Operator (1 user)
CA Thin Client Server Connection
3rd party CTI Interface
Multiple CTI Connection
Built-in ACD Report / Announcement of waiting order in queue

# 7. Activation Key - Condition

When only **one CTI server except CA** is connected with PBX, **KX-NSF101 activation key** is required.

- When other CTI server application is connected through CSTA MUX, **KX-NSA020 activation key for CSTA MUX** is required.  
KX-NSF101 activation key for CTI (server) interface is NOT required in this case.

KX-NSF101	Activation Key for CTI interface (CTI interface)	KX-NSA020	Activation Key for Multiple CSTA Connection (CSTA Multiplexer)
-----------	--	-----------	--

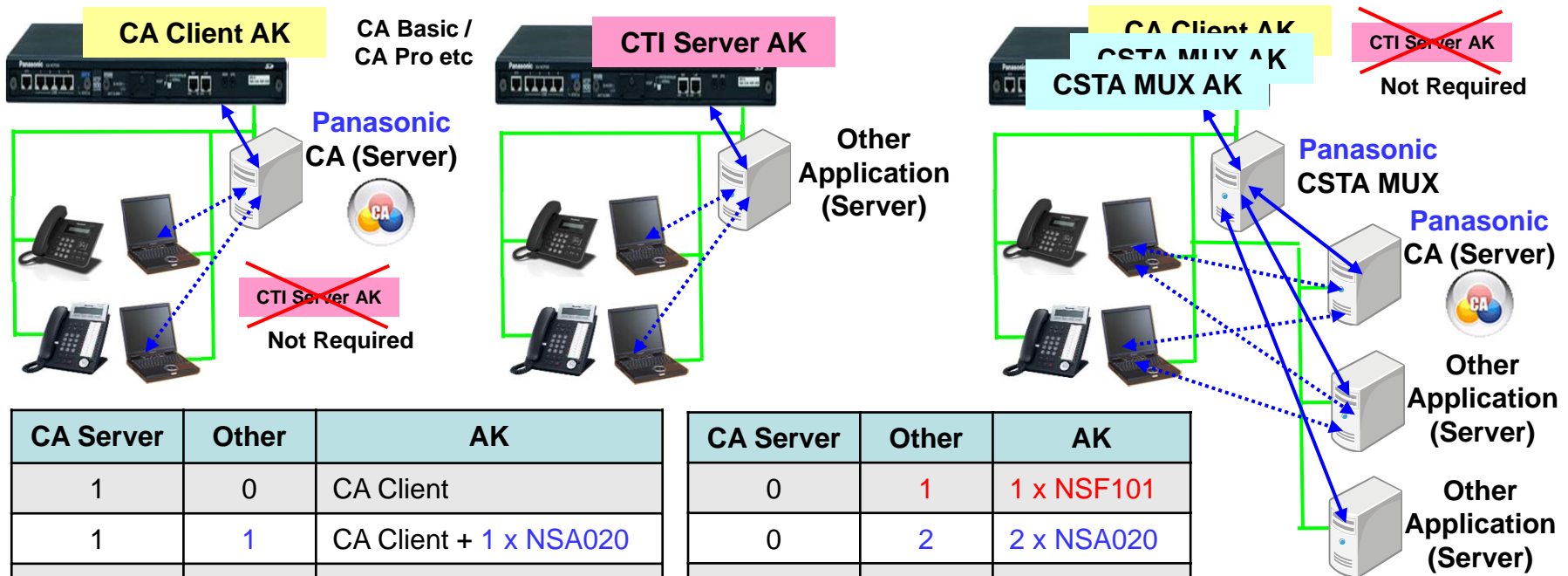

CA Server	Other	AK
1	0	CA Client
1	1	CA Client + 1 x NSA020
1	2	CA Client + 2 x NSA020
1	3	CA Client + 3 x NSA020

CA Server	Other	AK
0	1	1 x NSF101
0	2	2 x NSA020
0	3	3 x NSA020
0	4	4 x NSA020

## 8. Activation Key - Condition

Following activation key is only for KX-NS1000.

	Feature	Model Name	Description
IP Extension Capacity	Up to 50 IP Phone Capacity	KX-NSM005	Max 31-50ch of IP extension is activated
	Up to 100 IP Phone Capacity	KX-NSM010	Max 31-100ch of IP extension is activated
	Up to 300 IP Phone Capacity	KX-NSM030	Max 31-300ch of IP extension is activated
	Up to system limit IP Phone Capacity	KX-NSM099	Max 31-640ch of IP extension is activated
	Expansion AK from NSM005	KX-NSX910	IP Phone Capacity Expansion Activation Key from NSM005
	Expansion AK from NSM010	KX-NSX930	IP Phone Capacity Expansion Activation Key from NSM010
	Expansion AK from NSM030	KX-NSX999	IP Phone Capacity Expansion Activation Key from NSM030
Network	Built-in Router	KX-NSN101	Activate Router function, 1 key per Main Unit
	IPsec (VPN) (16sessions)	KX-NSN216	Activate 16 sessions of IP-VPN (IPsec) for Built-in Router.
UM Function	Recording Time Expansion	KX-NSU001	Recording time 2h → 15h

## V4.3 Key Feature Enhancement List

#	Items
<b>1. One-look Networking Survivability Improvement</b>	
1-0	Overview
1-1	Automatic Recovery (Isolated to Normal)
<b>2. New SIP Terminals</b>	
2-0	Overview
2-1	KX-HDV230/330/430
2-2	KX-NTV150/160
<b>3. Maintenance improvement</b>	
<b>4. Other</b>	



# One-look Networking Survivability Improvement

## Automatic recovery from Isolated Mode

### 1) Immediate recovery

As soon as the Master unit found the slave unit in Isolated Mode, the master unit send command immediately to slave to switch into Normal operation Mode.

### 2) Scheduled recovery

The master unit checks the mode of slaves based on the period set at system (Daily/Weekly/Monthly). The master found isolated slave at the period then the master send command to the slave to recover into Normal operation Mode.

The schedule can be set as system based programming.

**When Backup Master is set then this feature can't be set.**

# New SIP Terminals

V4.3 supports new SIP terminals called P-SIP (Panasonic SIP) as followings,

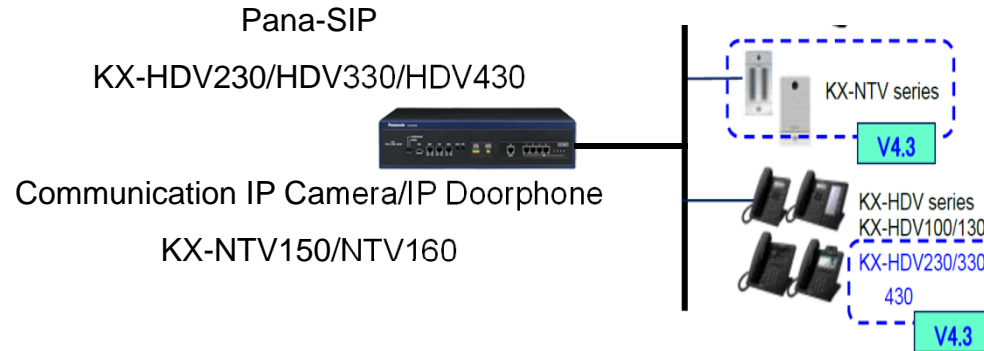

Item	Pana-SIP Communication IP Camera/Video Doorphone	UT series	3 <sup>rd</sup> party SIP phone
Activation Key	NSM5xx/NSM2xx	NSM5xx/NSM2xx	NSM7xx
V-Card Type	V-SIPEXT	V-UTEXT	V-SIPEXT
Feature	SIP-SLT (Same as 3 <sup>rd</sup> party SIP phone)	SIP-MLT	SIP-SLT

# KX-HDV SIP Phone Line-up ( New )



KX-HDV100 KX-HDV130 KX-HDV230 KX-HDV330 KX-HDV430

	HDV100	HDV130	HDV230	HDV330	HDV430
PoE (IEEE 802.3af)	N/A	Yes (AC adaptor is also available.)			
2nd LAN	N/A	Yes			
Flexible key	2	2	12+12	8x3 on LCD	
KX-HDV20	N/A	N/A	Max. 5	Max. 5	
Headset	N/A	N/A	EHS	EHS / BT	

BT = Bluetooth version 2.1 is supported.



KX-HDV20  
for one touch key  
for KX-NS/NSX PBX

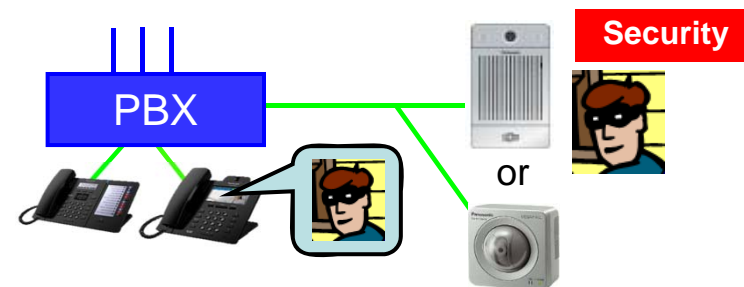

One stop solution by Panasonic

# Required Activation key and Virtual Card

KX-NS PBX supports more feature for KX-NT than KX-UT phone.  
KX-NS PBX supports more feature for KX-UT than KX-HDV phone.

Feature for KX-HDV phone is basically same as 3rd party SIP phone.

- Paging call (\*33XX) cannot be answered automatically.
- CTI control through PBX is not available.

[KX-HDV230/330/430](#) supports [uaCSTA](#) (CSTA for SIP Phone User Agents).

KX-NS version 4.2 is required for KX-HDV100/130.

KX-NS [version 4.3](#) is required for [KX-HDV230/330/430](#) and [KX-NTV](#).

Phone	Protocol	Virtual card	AK for KX-NS (Not for KX-NSX)
KX-NT	MGCP	V-IPEXT card	<a href="#">KX-NSM5xx</a>
KX-UT	<a href="#">SIP</a>	V-UTEXT card	<a href="#">KX-NSM5xx</a>
<a href="#">KX-HDV / KX-NTV</a>	<a href="#">SIP</a>	<a href="#">V-SIPEXT card</a>	<a href="#">KX-NSM5xx</a>
3 <sup>rd</sup> party SIP phone	<a href="#">SIP</a>	<a href="#">V-SIPEXT card</a>	KX-NSM7xx

# Flexible Key

KX-NT supports more features for flexible key.

## < KX-NT >

Loop CO	System Alarm
Single CO	Time Service
Group CO	Answer
DSS	Release
One-touch	TRS Level Change
ICD Group	ISDN Service
Message Waiting	CLIR
FWD/DND (Both)	COLR
FWD/DND (External)	ISDN Hold
FWD/DND (Internal)	Headset
Group Fwd (Both)	Time Service - Automatic/Manual
Group Fwd (External)	Check In
Group Fwd (Internal)	Check Out
Account	Cleaned Up
Conference	Two-way Record
Terminate	Two-way Transfer
EFA	LCS
Charge	Voice Mail Transfer
Call Park	NDSS
Call Log	CTI
Log-in/Log-out	PDN
Hurry-up	SDN
Wrap-up	

## < KX-UT >

Single CO  
DN  
One-touch  
Headset  
Log-in/Log-out  
DSS  
Wrap-up  
Call Park

## <KX-HDV>

One touch dial key only

KX-HDV phone may support more features (DSS key for example) when KX-HDV is connected with public SIP carrier. This depends on specification of the carrier.

## During Busy tone or DND tone

SIP phone including KX-HDV and KX-UT does NOT support features during listening to busy tone or DND tone.

For example,

- (1) KX-UT user calls other extension.
  - (2) Other extension is busy or sets DND.
  - (3) KX-UT user listens to busy tone or DND tone.
- => KX-UT does NOT support following features.  
KX-NT supports these features.

BSS / OHCA / Whisper OHCA / DND Override	:	<input type="text" value="1"/>
Executive Busy Override	:	<input type="text" value="3"/>
Alternate Calling - Ring / Voice	:	<input type="text" value="*"/>
Message Waiting Set	:	<input type="text" value="4"/>
Call Monitor	:	<input type="text" value="5"/>
Automatic Callback Busy	:	<input type="text" value="6"/>

# New SIP Terminals

**KX-HDV230**



Advanced Features

- 2.3-inch Graphical LCD with Backlight
- 5.0-inch Graphical Self-Labeling LCD with Backlight
  - 6 SIP Accounts
  - 2 Gigabit Ethernet Port & PoE
  - Full Duplex Speaker Phone
- 3 Soft Keys and 24 (12 × 2) FF Keys with LED
  - Navigation Key
- Headset Jack (RJ9) Supported
  - EHS (3.5 mm) Supported
- Expansion Module Supported

**Large Self-Labeling LCD with Backlight**

The large, 5.0-inch LCD shows a large number of text characters, for excellent visibility and easy operation.

**24(12 × 2) FF Keys with LED**

**Comes standard-equipped with 24 FF keys.**

**Ideal for persons who frequently use telecommunications.**

# New SIP Terminals

KX-HDV330



## Advanced Features

- 4.3-inch Touch Panel LCD with Backlight
  - 12 SIP Accounts
- 2 Gigabit Ethernet Port and PoE
  - Full Duplex Speaker Phone
    - 24 (8 × 3) FF Keys
- Headset Jack (RJ9) Supported
  - EHS (3.5mm) Supported
    - Built-in Bluetooth®
- Expansion Module Supported

The LCD is easy to read, and the touch panel is easier to operate than buttons.

Recommended for supervisor use.

Easy Operation

Touch panel

Built-in EHS and Bluetooth

Using a compatible headset, communication is possible while working or when away from the desk .



# New SIP Terminals

KX-HDV430



## Advanced Features

- 4.3-inch Touch Panel LCD with Backlight
- Video Communication Supported (H.264)
  - 16 SIP Accounts
- 2 Gigabit Ethernet Port and PoE
  - Full Duplex Speaker Phone
  - 24 (8 × 3) FF Keys
- Headset Jack (RJ9) Supported
  - EHS (3.5 mm) Supported
- Built-in Bluetooth®
- Expansion Module Supported

## Video Communication

Recommended for persons who often have videoconferences at their desk. Monitoring is also possible connected to IP cameras. Ideal for supervisors or receptionists.

## Easy Operation

FF Keys are also easy to operate with the Touch Panel.

## Built-in EHS and Bluetooth

Using a compatible headset, communication is possible while working or when away from the desk .

# Communication IP Camera/IP Doorphone



System

Specification

## Clear Voice

Enables comfortable voice with video communication

## PBX Integration as extension

One Touch Call, Auto Dialing by sensor function, Remote connection

## Easy Installation

Easy & Flexible Installation ( Standard hole )  
Support Wi-Fi Connection ( NTV150 )



Deployed and works as PBX SIP Extension



External Sensor

LAN/PoE

WiFi

AC Adaptor

NTV150

Built-in Speaker & Mic

Call Button

## General Specification

Protocol	SIP
Interface	NTV150: PoE/LAN (WiFi) , AC Adapter(option) NTV160: PoE only, IP43
Camera	Resolution:1600 x 1200(2MP),Angle :92° x 70°
Video	30fps@1600x1200,
IN/OUT port	1 Each

# Maintenance Improvement

## Isolated site list on the operation

When Isolated Mode recovery operations from the Web-MC of master unit, the list shows all site that includes sites in Normal operation Mode on previous version.

From version 4.3, it shows only sites in Isolated Mode (Fault status).

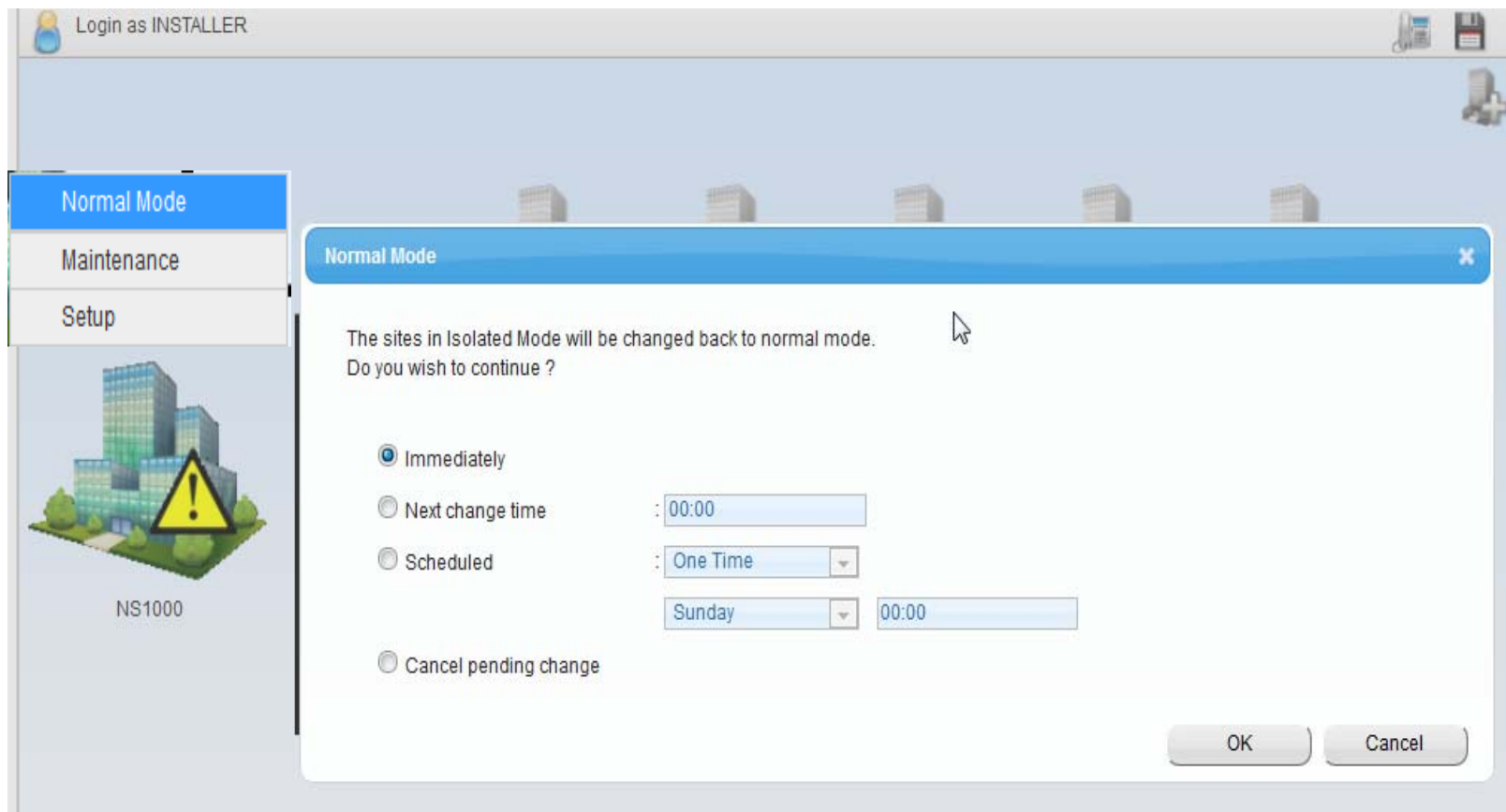

# Maintenance Improvement

## Default of Line number to display

The default value of the line number on the following Web-MC menu is increased to 100 from 20.

- PBX Configuration-4.Extension-1.Wired Extension-1.Extension Settings
- PBX Configuration-4.Extension- 2.Portable Station-1.Extension Settings

1	1	8	11	UM	VM
1	1	8	12	UM	VM
1	1	8	13	UM	VM

III

Page 1 of 1 100 ▼

## New Activation Key

Following Activation keys are added from version 4.3.

KX-NSXF021 and KX-NSXF022 are a separated AK from Call center Feature Enhancement (KX-NSF201).

Ether KX-NSF201 or one of the new AK is required for Queue Announcement or built-in ACD.

Model Name	Feature	Description
KX-NSXF021	Activation Key for Queue Announcement	Announcement of waiting number for queuing. Centralized type of Activation key *1
KX-NSXF022	Activation Key for Built-in ACD report	Built-in ACD Report Centralized type of Activation key *1

\*1: Centralized Type: Needs to install in a master unit only and provides the function to all units

# PBX Built-in Solution

KX-TVM version 3 based **Voice Mail** function is **built-in**.  
Memory card, VoIP DSP card and activation key are required for full KX-TVM function.

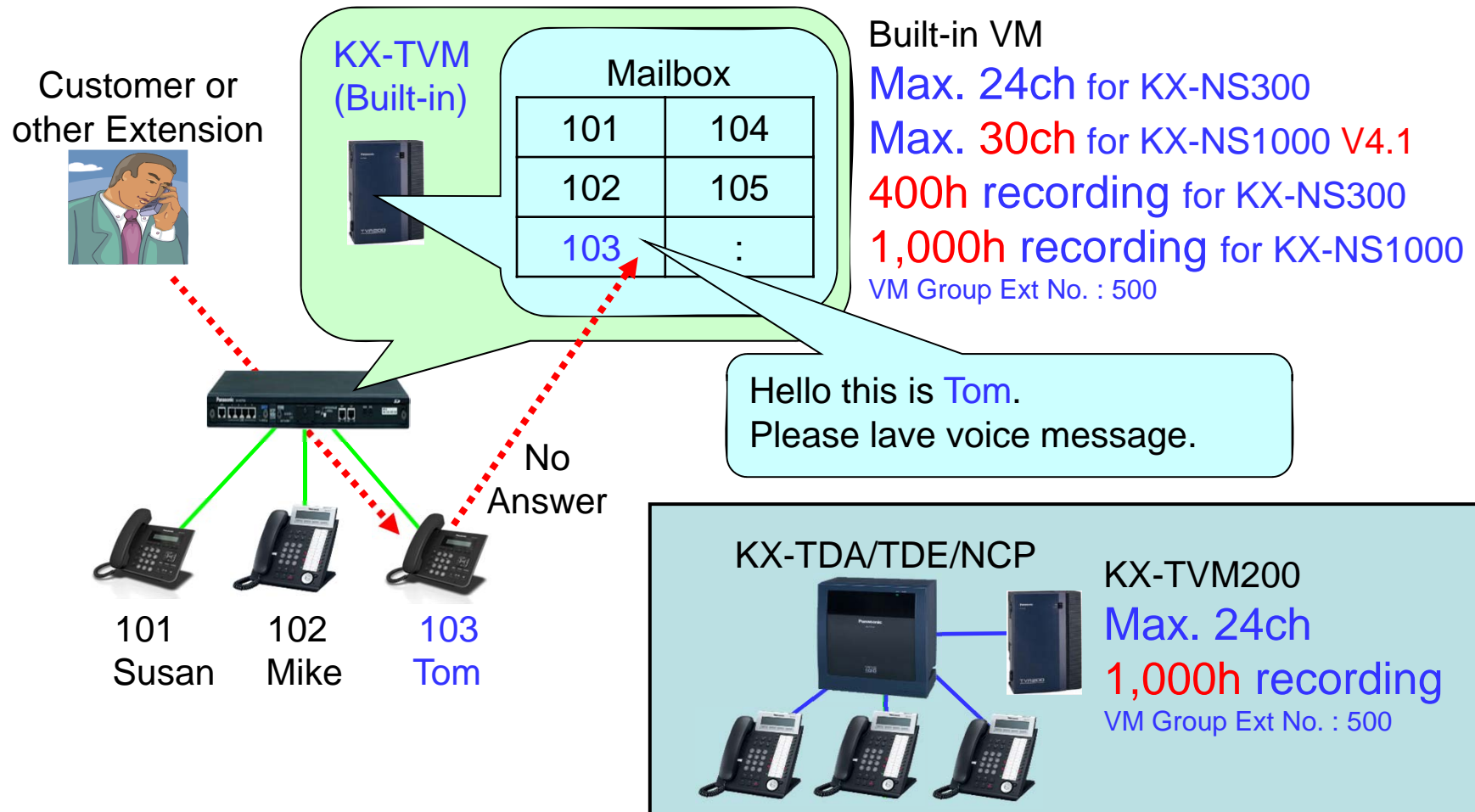

KX-TVM version 3 based Voice Mail function is built-in.

Memory card, VoIP DSP card and activation key are required for full KX-TVM function.

<KX-NS300>		<KX-NS1000 with DSP>	
Without SD or without DSP	2h Same feature as SVM on OPB3 card of TDA/TDE/NCP.	(Factory pre-installed)	Compact Flash : 2h Same feature as KX-TVM
KX-NS3134	2G SD card : 40h DSP is also required.	KX-NSU001	AK : 15h with above Compact Flash
KX-NS3135	8G SD card : 200h DSP is also required.	KX-NS0135	Compact Flash : 200h
KX-NS3136	16G SD card : 400h DSP is also required	KX-NS0136	Compact Flash : 450h
		KX-NS0137	Compact Flash : 1,000h

<For KX-NS300 / KX-NS1000 Common>

KX-NSU102	AK : More 2-ch	KX-NSU2xx	AK : E-mail for xx users
KX-NSU104	AK : More 4-ch	KX-NSU3xx	AK : 2-way Recording for xx users using PT [2-way Record] button or CA



Activation key is required to increase channels.  
1<sup>st</sup> 2-ch is supported with KX-NSF990.

KX-NSU102	AK : More 2-ch
KX-NSU104	AK : More 4-ch

<KX-NS300>

DSP	SD	AK	→	Simple VM	DISA	Built-in TVM
No	No	No	→	2ch		N/A
Yes	No	No	→	2ch	Up to free DSP (Max. 30ch)	N/A
Yes	Yes	KX-NSF990	→	2ch		2ch
Yes	Yes	KX-NSF990+ KX-NSU10x	→	2ch		Max. 24ch

<KX-NS1000>

DSP	Compact Flash	AK	→	Simple VM	DISA	Built-in TVM
Yes	Factory pre-install or Option	No	→	N/A	Up to free DSP (Max. 64ch)	2ch
Yes		KX-NSU10x	→	N/A		Max. 30ch

DISA is supported without “OPB3 card” and “SVM or MSG card”.

Supervisor can record call for other extension to built-in VM automatically. This is useful for call center or for reducing unnecessary call such as call to personal friend using company phone cost during working time.

Activation key : KX-NSU002 is required. (KX-NSU3xx is not required.)

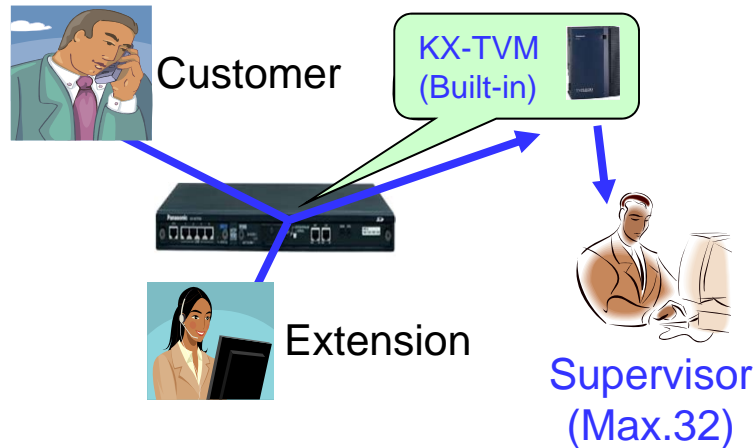

Easy programming and playing for supervisor using built-in web server

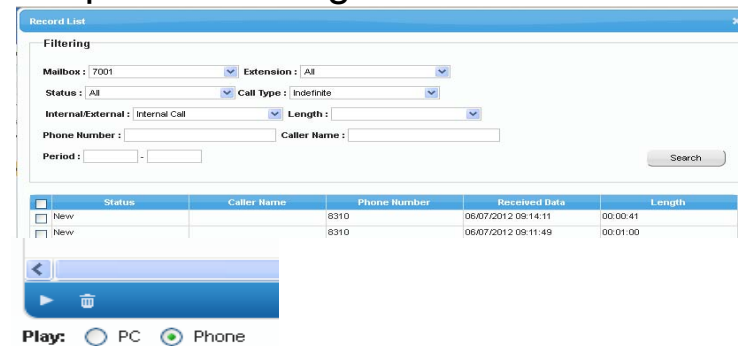

KX-NS300 can record max. 24 calls at the same time.

KX-NS1000 one cabinet can record max. 30 calls at the same time.

KX-NS1000 one look network supports max. 16 built-in VM in order to expand channels and recording capacity.



Back-up is available for recording to server (NAS) or USB memory automatically by schedule if maximum recording capacity is not enough. KX-NS PBX has USB port.

Activation key : KX-NSU003 is required for back-up.

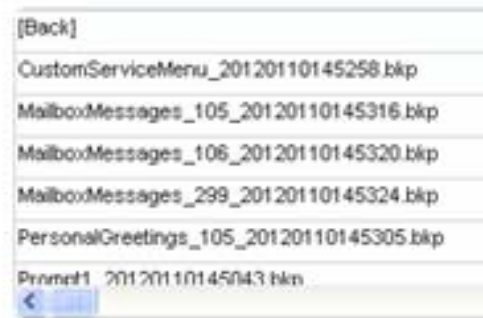

WAV converter is provided by Panasonic.

A list of WAV files with their sizes. A red dashed arrow points from the text above to the first file in the list.

rcvm0009_0800000120802124810.wav	1,407 KB
rcvm0009_0800000120802130145.wav	995 KB
rcvm0009_0800000120822154657.wav	66 KB
rcvm0009_0800000120824160139.wav	102 KB
rcvm0009_0800000120824160740.wav	208 KB
rcvm0009_0800000120824160959.wav	164 KB



Year, date and time are included in the file name.

YYMMDD : 12 08 02  
HHMMSS : 12 48 10

Built-in MRG feature supports **remote IP extension without VPN.**

MRG = Media Relay Gateway

Following phones support this feature.

- KX-NT543/NT546/NT560 (Version up of phone software is required.)
- KX-NT511 and KX-NT550 series
- KX-UT/HDV series
- 3rd party SIP phone with Blank UDP transmit capability. (Video phone is also supported.)
- **KX-NT300 based software phone version 4**

Other phones do not support this feature.

KX-UDT / KX-NT300 (hardware IP phone) series

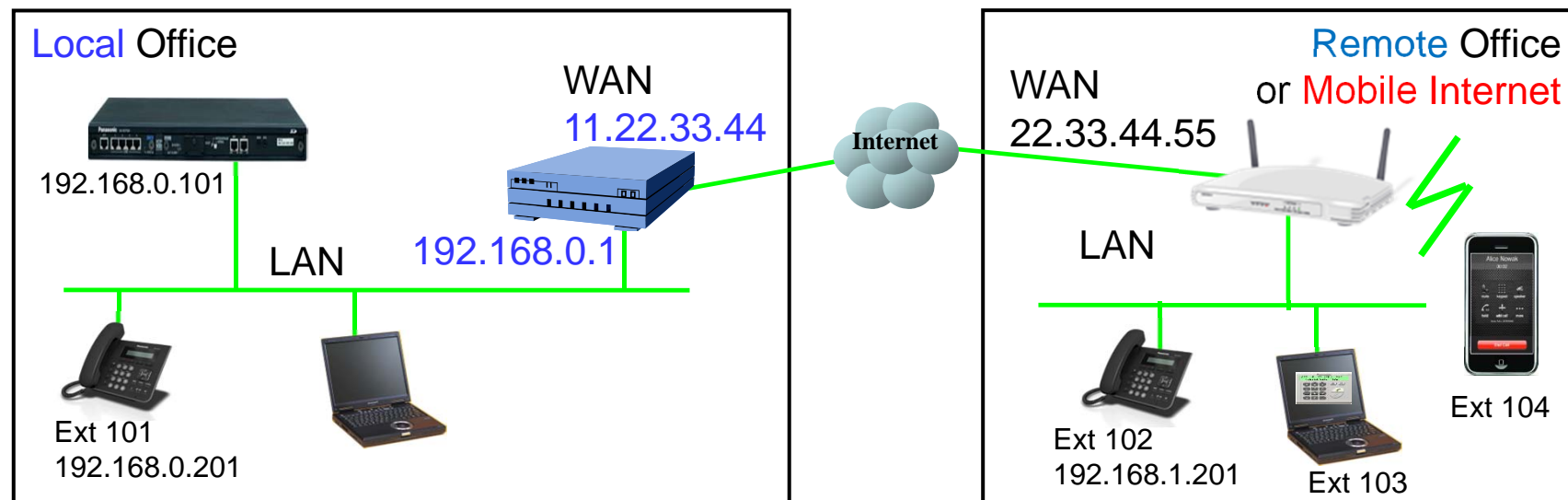

IP address in above picture is example.

Any extension user including software-phone in **smart-phone** can make a conference group call. All **32 members can talk**. (Not only listen.)

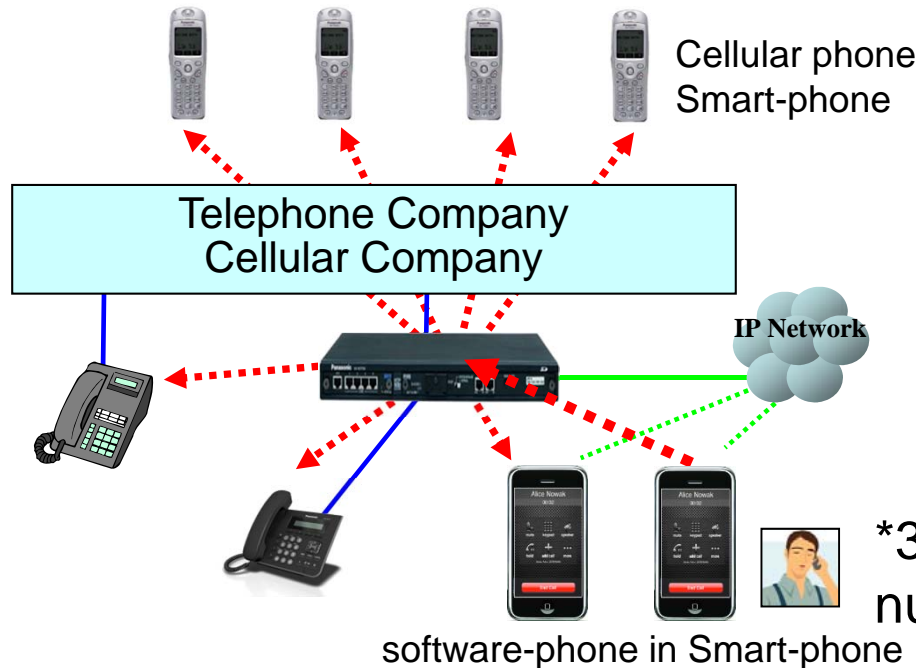

If member cannot answer the call or member is not called because not programmed as member, they can join by **PIN** through DISA after one or more members answer the call. Extension user can dial **PIN** directly without DISA.

**\*32 - Conference group number (1-8) - PIN #**

Feature	KX-NS300 without DSP	KX-NS300 with DSP	KX-NS1000 with DSP
Conference group call : Dial *32 Max. 32 members	Yes (32ch)		Yes (90 ch)
Other conference such as PT [Conference] key Max. 8 members			32 conference + other 32 conference + other 26 conference for example

# Installation

# 1. Virtual IP Card ( NS300 )

Capacity of Virtual IP card is as follows.

Virtual IP Card for	Capacity
Trunk (SIP or H.323 )	4 x 4-ch card or one 16-ch card
Extension (KX-NT or KX-UT or SIP)	4 x 8-ch card or one 32-ch card

The screenshot displays the configuration interface for a Panasonic KX-NS300 system. On the left is a navigation menu with categories like '1. Configuration', '2. System', and '3. Group'. The main area shows a rack of slots numbered 1 to 16. Slots 1-4 are labeled 'Trunk' and contain 'V-IPGW4' cards. Slots 5-8 are labeled 'Extension' and contain 'V-IPEXT8' cards. Slots 9-16 are labeled 'Virtual' and contain 'V-IPCS4' cards. Above the rack, there are summary boxes for 'Trunk Slot Card' (listing V-SIPGW4, V-SIPGW16, V-IPGW4, V-IPGW16) and 'Extension Slot Card' (listing V-IPEXT8, V-IPEXT32, V-SIPEXT8, V-SIPEXT32, V-UTEEXT8, V-UTEEXT32, and V-IPCS4).

# PRI : Switch for ISDN Extension / QSIG

<Question>

Does PRI card (KX-NS5290) support ISDN Extension / QSIG?

<Answer>

Yes.

When KX-NS5290 and KX-NS5290 are connected, **cross cable** is required. KX-NS5290 does not support switch like KX-TDA0290.



KX-TDA0290

KX-TDA/TDE



ISDN Extension

Straight

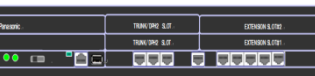

Cross

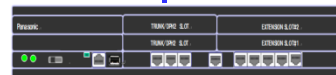
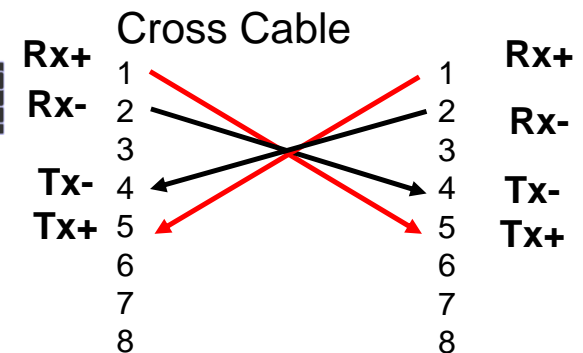

ISDN Trunk

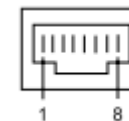
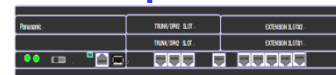



## 2. VoIP DSP Card

Capacity of **DSP** can be confirmed using programming tool **without PBX** before installation. (Off-line mode)

The screenshot shows the 'DSP Resource Advisor' window. At the top, a summary table is circled in red, showing 'Slot' as 'DSP-S' and 'Total Power' as '61'. Below this is a large table with columns for Services, Codec, Ports, Busy Ratio (%), and Power. The table is divided into 'Trunk' and 'Extension' sections. The 'Extension' section includes 'OGM' with 30 ports and 60.0 power, which is circled in red. A second table at the bottom shows 'Unified Message', 'OGM', 'Conference', and 'Free Resource' with their respective power values.

Slot	DSP-S
Total Power	61

Services	Codec	Ports	Busy Ratio (%)	Power	
Voice Call	Trunk	G.729	▲▼	▲▼	
		G.711	▲▼	▲▼	
		TDM	▲▼	▲▼	
	Extension	G.729	▲▼	▲▼	
		G.711	▲▼	▲▼	
		IP-CS (G.729)	▲▼	▲▼	
		IP-CS (G.711)	▲▼	▲▼	
	VoIP Total				

Services	Detail	Ports	Power
Unified Message	Call Recording		▲▼
	Two-way Recording		▲▼
OGM	OGM	30	▲▼ 60.0
Conference	Conference		▲▼
Free Resource			1.0

**KX-NS1000**

# 1. Introduction

KX-NS1000 is bigger capacity model of KX-NS PBX series.  
KX-NS1000 supports 1,000 extensions.

1,000 IP phone or 1,000 Digital PT or 1,000 SLT or 1,000 mixture

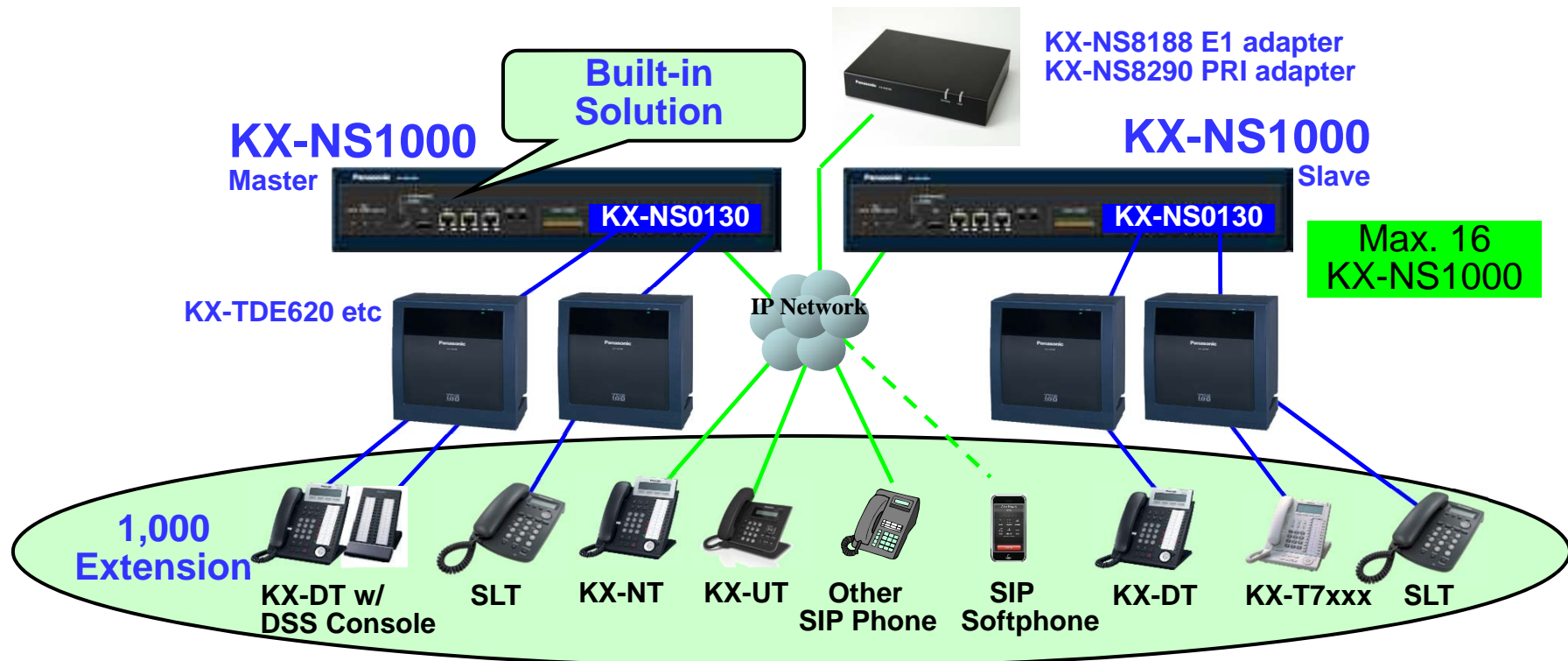

100 % Feature transparency like TDE600 and TDE620

## 2. Feature Difference

**KX-NS small PBX** and **KX-NS1000** have same feature basically like KX-NCP and KX-TDE. Feature difference is as follows.

Feature	<b>KX-NS small PBX</b>	<b>KX-NS1000</b>
One-look network	Yes (as slave)	Yes
Trunk Adapter : KX-NS8188/8290	See "1. NSx00 Basic Spec 201y-xxxx.pptx."	Yes
RS232 port	No but SMDR through LAN	Yes
LAN port	10/100 Base TX	10/100/1000
WAN port	No	Yes
MNT port	No but USB port with adapter	Yes
Fax to e-mail	No	Yes
Sensor to e-mail	Yes	Yes (Version 4.1)
Built in VM (UM)	24-ch	30-ch (Version 4.1)
Simple VM	Yes (*)	No
Modem : KX-TDA0196	Yes (*)	No
PT Program	Yes (*)	No
40,000 calls SMDR by SD	Yes (*)	No

(\*) These features are not available when **KX-NS small PBX** is connected with **KX-NS1000** by one-look network.

## 2. Pre-installed Activation Key

Following features are available **without buying activation key** and **without expiration**.

IP Extension for KX-NT/UT/HDV hardware phone : **8ch**

- Not for KX-NT700 and KX-NT based software phone
  - Not for 3<sup>rd</sup> party SIP phone
- => Easy to sell Panasonic KX-NT/UT/HDV

UM (Built-in KX-TVM) : 2 ch

CA Basic : All users

# 3. Capacity

Capacity is as follows.

Line	NS1000 x 1	NS1000 x 2	NS1000 x 3 to 16
<b>Trunk</b>	<b>256</b>	256 x 2	<b>600</b>
Legacy	256	256 x 2	600
IP incl E1/PRI adapter	256	<b>256</b>	
SIP incl PRI Public mode	256	256	
<b>H.323</b> incl PRI QSIG mode	<b>48</b>	<b>96</b>	
<b>Extension</b>	<b>640</b>	<b>1000</b>	
Digital PT / Analog PT / SLT	480 SLT (*1) 512 DPT (*2)	1000	
IP	640	1000	

600 Trunk + 1000 Extension is available.

Trunk + Extension total capacity of KX-TDE600 was limited because total 43 free slot by KX-TDE600 + 3 x KX-TDE620. But KX-NS1000 can support **lots of** KX-TDE620.

(\*1) 24SLT x 10 by TDE620 x 2 for example

(\*2) 256 DPT including DXDP by TDE620 x 2 for example

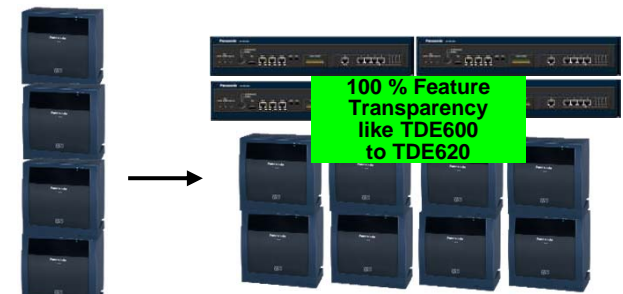

TDE600 +  
TDE620 x 3

NS1000 x 4 +  
TDE620 x 8 **for example**

1000 Digital PT is available using Digital XDP because one DLC16 occupies 32-ch.

# 4.1 Selectable System capacity

## Selectable Extension capacity

Type		Stand alone	One Look
<b>Type1</b>			
<b>Extension Capacity</b>		<b>640</b>	<b>1000</b>
	<b>IP-PT (KX-NT series)</b>	<b>256</b>	<b>1000</b>
	<b>SIP</b>	<b>640</b>	<b>1000</b>
	<b>SIP Phone</b>	<b>640</b>	<b>1000</b>
	<b>KX-UT series</b>	<b>640</b>	<b>1000</b>
<b>Type 2</b>			
<b>Extension Capacity</b>		<b>640</b>	<b>1000</b>
	<b>IP-PT (KX-NT series)</b>	<b>640</b>	<b>1000</b>
	<b>SIP</b>	<b>256</b>	<b>1000</b>
	<b>SIP Phone</b>	<b>256</b>	<b>1000</b>
	<b>KX-UT series</b>	<b>256</b>	<b>1000</b>
<b>Type 3</b>			
<b>Extension Capacity</b>		<b>640</b>	<b>1000</b>
	<b>IP-PT (KX-NT series)</b>	<b>256</b>	<b>1000</b>
	<b>SIP</b>	<b>384</b>	<b>1000</b>
	<b>SIP Phone</b>	<b>384</b>	<b>1000</b>
	<b>KX-UT series</b>	<b>384</b>	<b>1000</b>

## 4.2 Selectable System capacity

### Selectable IP-GW Capacity

When select Type3 mode, IP-GW (H323) capacity will be increased up to 96

Type		Stand alone	One Look
<b>Type1</b>			
<b>IP GW</b>		<b>256</b>	<b>256</b>
	<b>H323</b>	<b>48</b>	<b>96</b>
	<b>SIP</b>	<b>256</b>	<b>256</b>
<b>Type2</b>			
<b>IP GW</b>		<b>256</b>	<b>256</b>
	<b>H323</b>	<b>48</b>	<b>96</b>
	<b>SIP</b>	<b>256</b>	<b>256</b>
<b>Type3</b>			
<b>IP GW</b>		<b>256</b>	<b>256</b>
	<b>H323</b>	<b>96</b>	<b>128</b>
	<b>SIP</b>	<b>160</b>	<b>256</b>



## 4.3 Selectable System capacity

### Selectable Tenant Group capacity

When select Type3 mode Tenant Group capacity will be increased up to 128

Type		Stand alone	One Look
<b>Type1 - Tenant</b>			
	Tenant Group	32	32
	Time Table	32	32
	System Speed Dial	1000/Tenant	1000/Tenant
<b>Type2 - Tenant</b>			
	Tenant Group	32	32
	Time Table	32	32
	System Speed Dial	1000/Tenant	1000/Tenant
<b>Type3 - Tenant</b>			
	Tenant Group	<b>128</b>	<b>128</b>
	Time Table	<b>128</b>	<b>128</b>
	System Speed Dial	<b>300/Tenant</b>	<b>300/Tenant</b>

## 4.4 Selectable System capacity

Increase COS and Carrier for each Unit

Other resources will be increased

Resource		Before (V1,V2)	After (V3)
<b>Type1</b>			
	ARS Carrier	48	128
	No. of COS Group	64	512
	User Group	96	256
<b>Type2</b>			
	ARS Carrier	48	128
	No. of COS Group	64	512
	User Group	96	256
<b>Type3</b>			
	ARS Carrier	48	128
	No. of COS Group	64	512
	User Group	96	256

# 5. Capacity - Conditions

One VM channel reduces 10-port extension capacity of master PBX

- Default 2-ch does not reduce this.
- Extension capacity of slave PBX does not reduce

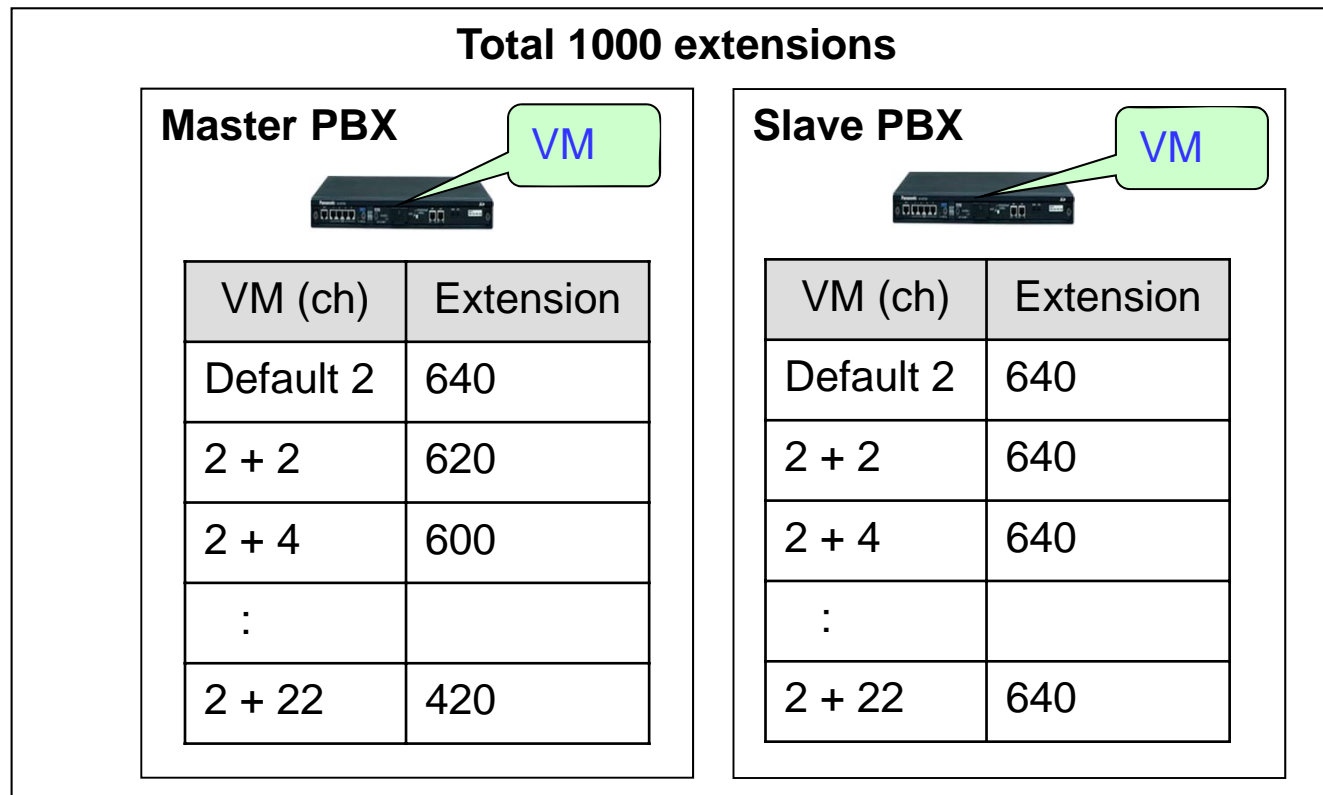

## 6. Optional Cards on Mother Board

<b>FAX Card Slot</b>	KX-NS0106	FAX Interface Card (FAX)
<b>DSP Card Slot</b>	KX-NS0110	VoIP DSP Card (S Type) (DSP S)
	KX-NS0111	VoIP DSP Card (M Type) (DSP M)
	KX-NS0112	VoIP DSP Card (L Type) (DSP L)
<b>Storage Memory Card Slot</b>	KX-NS0135	Storage Memory (S Type) (Storage Memory S)
	KX-NS0136	Storage Memory (M Type) (Storage Memory M)
	KX-NS0137	Storage Memory (L Type) (Storage Memory L)

Two DSP can be installed.

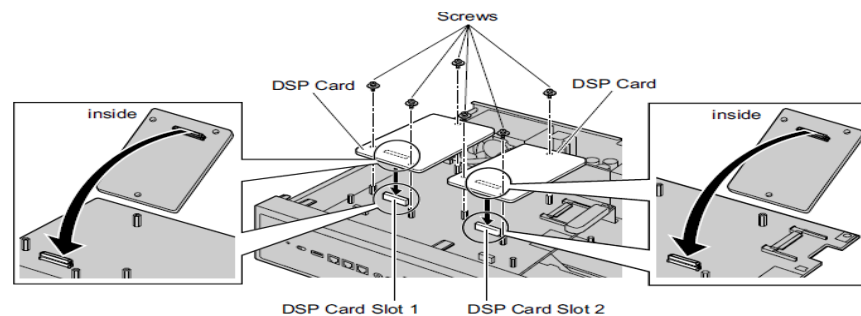

DSP Card Type	Number of Resources
DSP S	63
DSP M	127
DSP L	254

Hot swap is not available.

# 7. Optional Cards on Front

<b>Free Slot</b>	KX-NS0180	2-Port Analogue Trunk / 2-Port SLT Card (SLC2/LCOT2)
	KX-NS0280	4-Port BRI / 2-Port SLT Card (SLC2/BRI4)
	KX-NS0290CE	PRI30 / 2-Port SLT Card (SLC2/PRI30)
	KX-NS0290	PRI23 / 2-Port SLT Card (SLC2/PRI23)
	KX-NS0130	Stacking Master Card (STACK-M)
<b>Doorphone Slot</b>	KX-NS0161	Doorphone Interface Card (DOORPHONE)

A doorphone card for 1 doorphone, 1 door opener, and 1 external sensor.

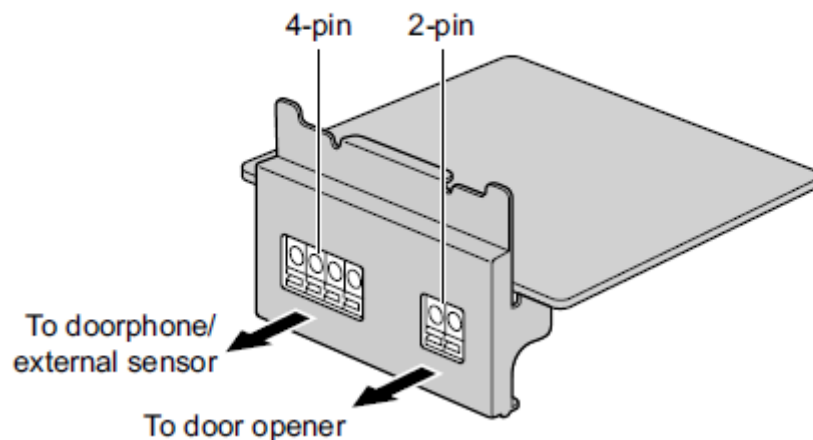

2 analogue trunk ports with Caller ID (FSK/FSK with Call Waiting Caller ID /DTMF). One port is a power failure transfer (PFT) port. 2 extension ports with Caller ID (FSK) for SLTs.

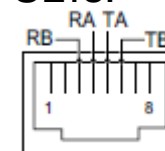

RB	Ring B
RA	Ring A
TA	Tip A
TB	Tip B

KX-NS1000



Hot swap is not available.

# 8.1 Stacking Card

When customer needs lots of analog SLT, digital PT, analog CO, PRI and so on, KX-NS1000 with stacking card KX-NS0130 is useful.

- KX-TDA100-200-600-620, KX-TDE or KX-NCP works as **slave unit**.
- **2 slave units** are supported with one KX-NS1000 by one KX-NS0130.
- KX-NS0131/0132 is installed to slave unit instead of MPR or BUS card.
- KX-TDA(E)620 cannot be connected with KX-TDA(E)600 by BUS card.

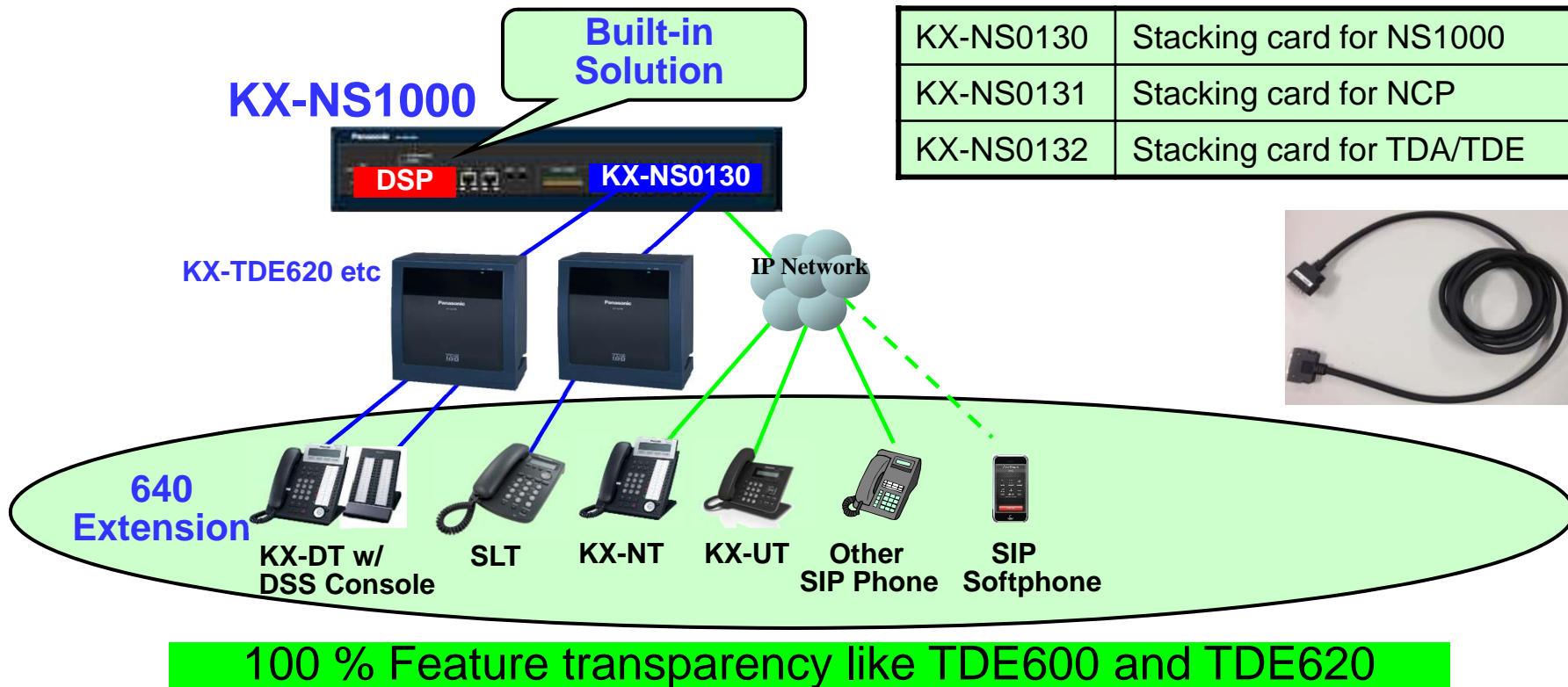

## 8.2 Stacking Card – Conditions

- Different PBX category cannot be mixed to one KX-NS1000.

Category 1 : KX-NCP500-1000

Category 2 : KX-TDE(A)100-200

Category 3 : KX-TDE(A)600-620

Category 4 : KX-TDA100D

NCP500+TDE200 : N/A

TDE100+TDA200 : OK

TDE600+TDE620 : OK

TDE620+TDE620 : OK

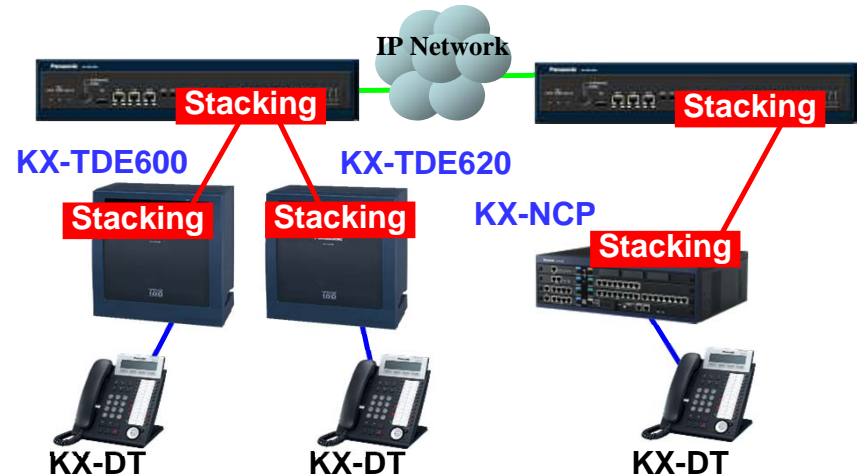

- Card configuration for optional cards in KX-TDA/TDE/NCP with stacking card does not change from KX-TDA/TDE/NCP with MPR.

For example,

Max. 4 PRI cards can be installed to KX-TDE200.

KX-TDA1178 cannot be installed to KX-TDA600.

Max. 5 KX-TDA1178 can be installed to KX-TDE200.

(MEC is not required for KX-TDA1176/1178 in KX-TDE100-200 with stacking card.)

- KX-TDA100-200-600-620 with stacking card is treated as KX-TDE100-200- 600-620 for above condition.

## 8.3 Stacking Card – Conditions

- Cards ทางด้านขาไม่รองรับ เนื่องจาก
  - MPR is removed. (Virtual IP card is not supported.)
  - IP feature is supported by KX-NS1000.
  - DISA feature is supported by KX-NS1000 using VoIP DSP card.
- IP phones should be registered to KX-NS1000. KX-NS1000 does NOT support KX-NT136, KX-NT400, KX-HGT100 and so on.
- IP capacity AK is not required for trunk and extension in existing PBXs because these are not IP.
- Other AK such as CA is required in KX-NS1000 for extension in existing PBX.
  
- In case of TDA100/200 and TDE100/200, OPB3 card with ECHO16 must be installed to Slot 1.
  - \*) Other cards except OPB3 or OPB3 card with other daughter board except ECHO16 can be installed to any slot.

### Not Supported

Symbol	Model
RMT	TDA0196
MEC	TDA0105/ TDE0105
DSP4	NCP1104
DSP16	TDE0110
DSP64	TDE0111
CTI-LINK	TDA0410
IP-EXT16	TDA0470
IP-GW4E	TDA0484
IP-GW16	TDA0490
IP GW4	TDA0480
MSG4	TDA0191
ESVM2	TDA0192
ESVM4	TDA0194



## 8.4 Add TDA100D as Legacy GW

Following cards are supported for Legacy Gateways

- For TDE100/200, TDA100D

Model	Symbol	Description
KX-TDA1176	MCSLC16	16-Port Single Line Telephone Card with Message Lamp Interface
KX-TDA1178	MCSLC24	24-Port Single Line Telephone Card with Message Lamp Interface

- For TDE600/620

Model	Symbol	Description
KX-TDA6179	EMCSLC24	24-Port Single Line Telephone Card with CID & Message Lamp Interface

- For TDA100D

Model	Symbol	Description
KX-TDA1180	CLCOT8	8-Port Analogue Trunk Card with CID
KX-TDA1186	CLCOT8E	8-Port Analogue Trunk with Caller ID daughter Card

# 9.1 One-look Networking

A maximum of **12 KX-TDA/TDE/NCP** and **16 KX-NS1000** can be connected for the entire One-look Network for **1,000 extensions**. One-look networking is similar to TDE600-TDE620 connection.

KX-NS1000 master works like KX-TDE600. Other units work like KX-TDE620. All programming is available through KX-NS1000 master like KX-TDE600.

*Activation key : KX-NSN001 is required for each KX-NS PBX.*

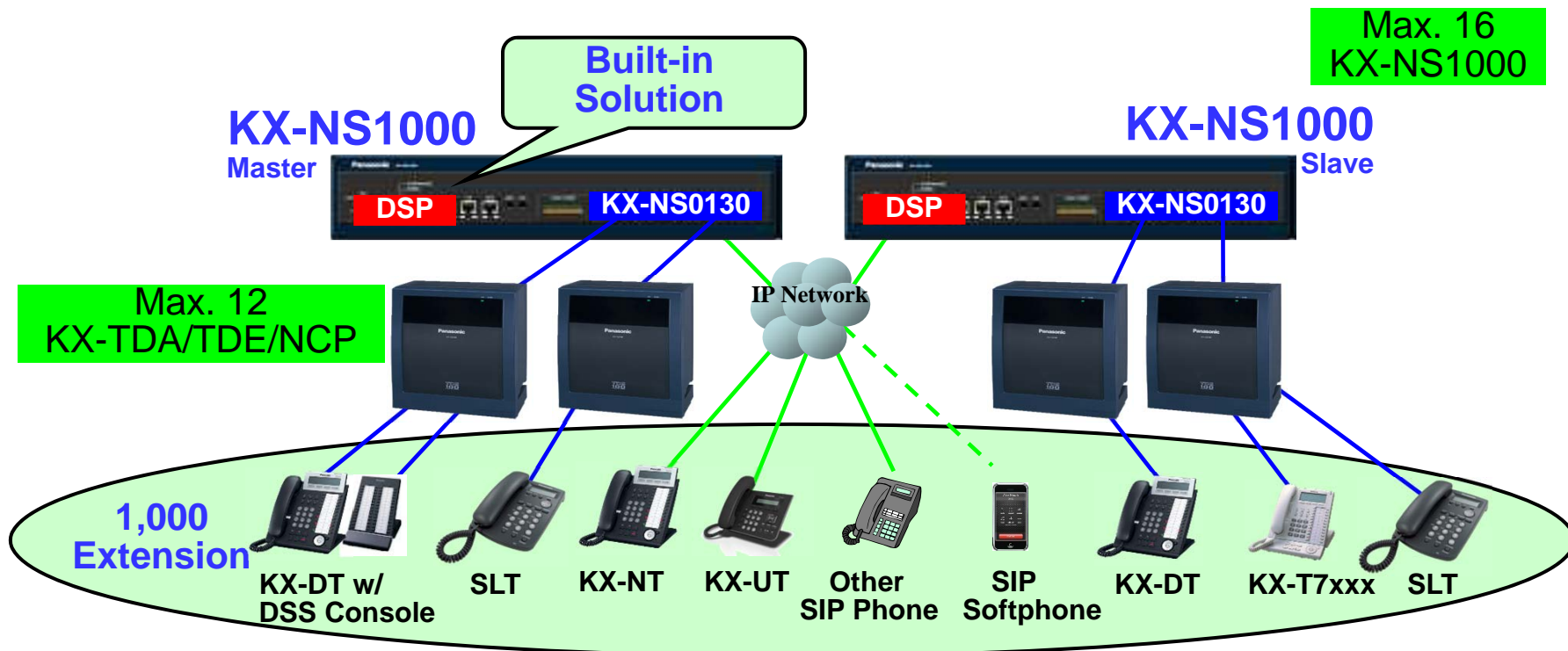

**100 % Feature transparency like TDE600 and TDE620**

# 9.2. One-look Networking with KX-NS small PBX

A maximum of 15 KX-NS small PBX also can be connected for the entire One-look Network as slave PBX. Master PBX should be KX-NS1000.

*Activation key : KX-NSN001 is required for each PBX.*

*Hardware : DSP such as KX-NS5110 is required because VoIP is used for connection.*

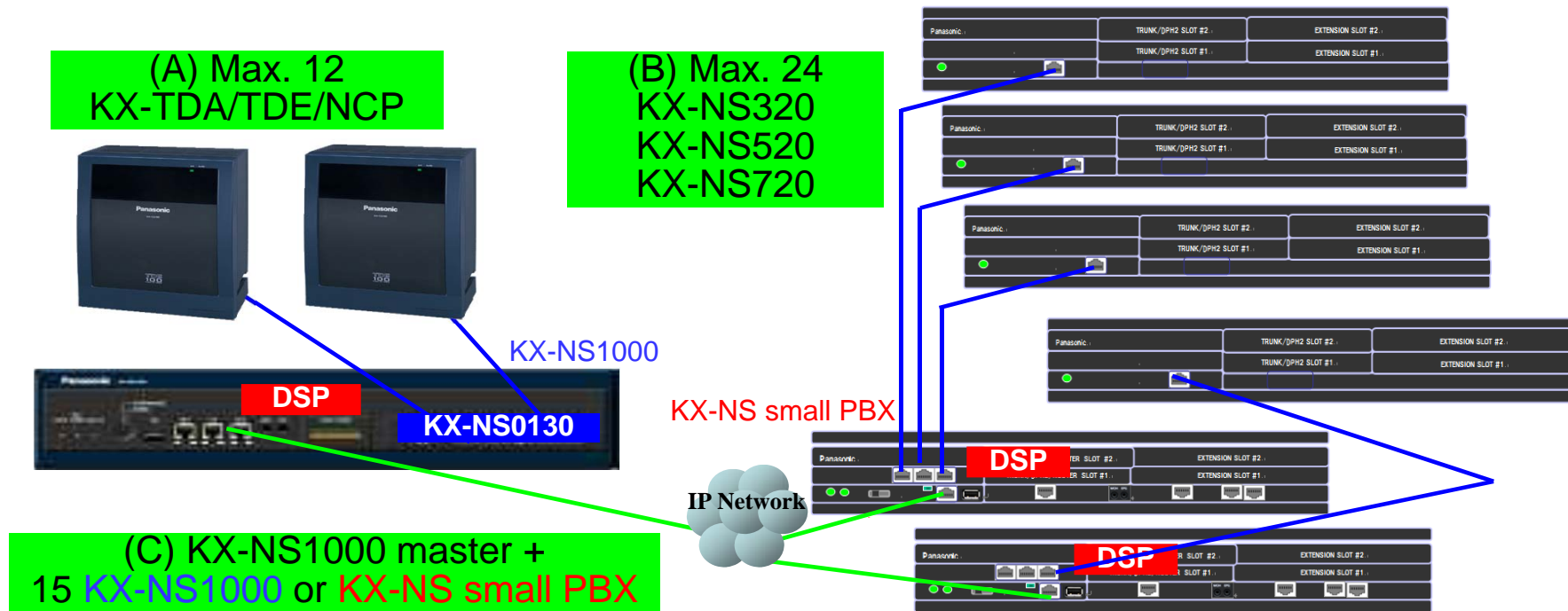

(A)+(B) Total	TDA/TDE/NCP	0	1	2	3	4	5	6	7	8	9	10	11	12
	NSx20	24	22	20	18	16	14	12	10	8	6	4	2	0

**KX-NS300** : KX-NSF990 AK and SD card such as KX-NS3134 are also required.

**KX-NS small PBX** cannot be master (including back-up master) because not enough CPU. 67

# 31. E1 / PRI Adapter

When customer needs IP-Phone mainly for extension and uses **E1 or more than 2 PRI** as trunk, **KX-NS1000 with trunk adapter** is useful. Trunk adapter is connected using **SIP** trunk.

Activation key for IP trunk is not required to connect E1 / PRI adapter. Trunk adapter cannot be connected with other PBX using SIP.

Model	Specifications
KX-NS8188X	E1 adapter on SIP trunk
KX-NS8290CE	PRI30 adapter on SIP trunk
KX-NS8290X	PRI23 adapter on SIP trunk



215 mm (W)  
44 mm (H)  
200 mm (D)  
500g

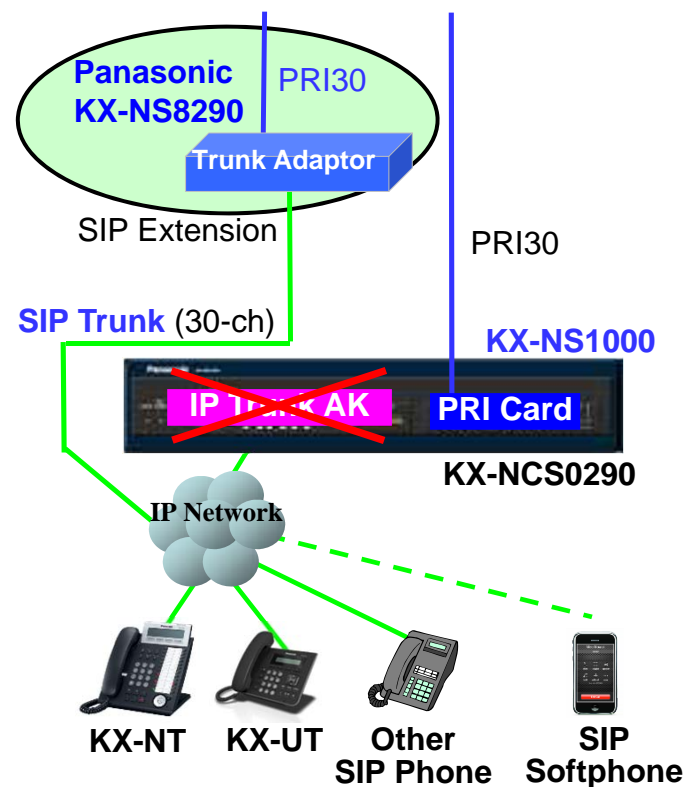

# 41. WAN (Built-in Router)

WAN (Built-in Router) is supported from KX-NS1000 version 3. Hardware for WAN is available since version 1 mass production.

*Activation key : KX-NSN101 is required.*

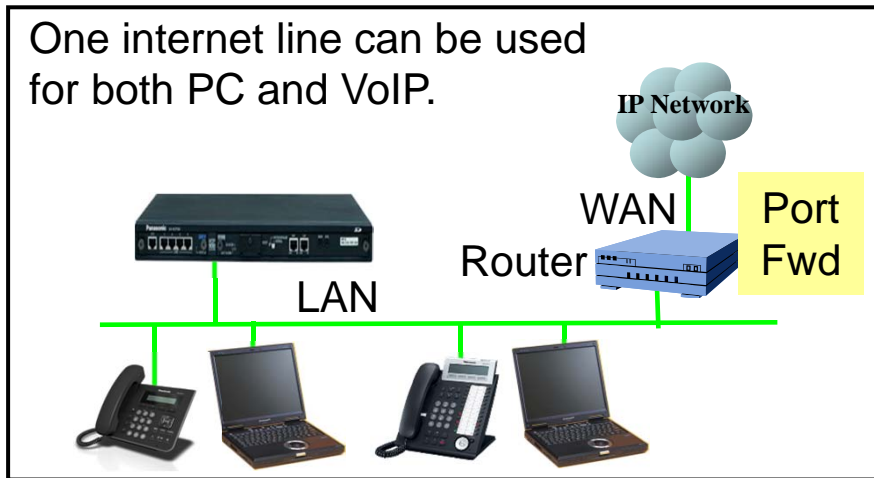

LAN for Maintenance  
223.0.0.1 (Default)

LAN (Customer's network)  
192.168.0.101 (Default)

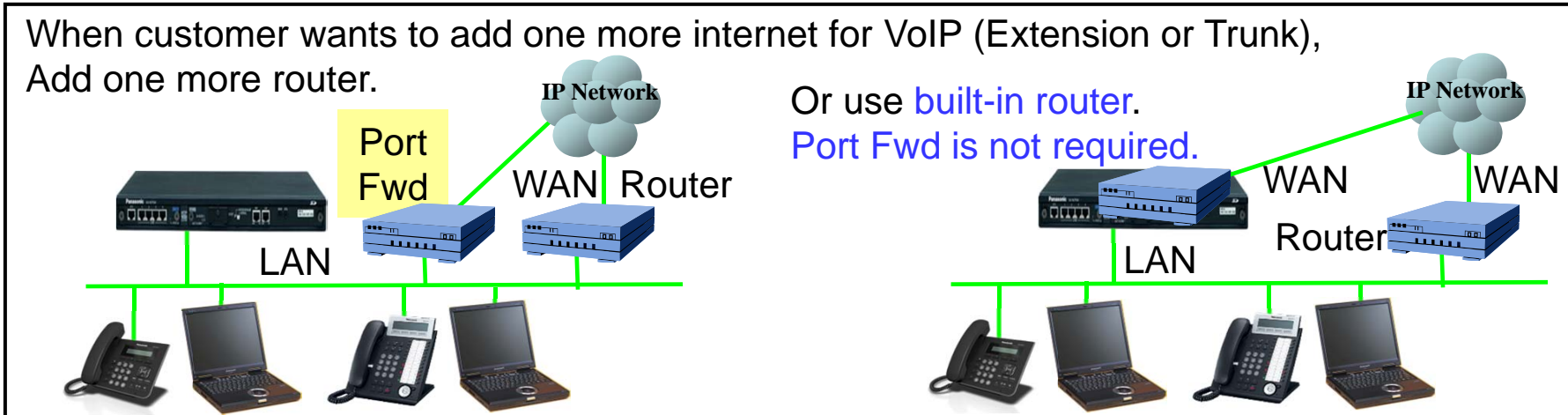

## 42. Built-in VPN

WAN / Built-in Router can support VPN (IP-SEC) feature also.  
VPN is required if one-kook network is configured using built-in router.

*Activation key :*

*KX-NSN216 is required. (KX-NSN101 is also required.)*

*One KX-NSN216 supports 16 VPN connection.*

*Max. two AKs can be supported for 32 VPN connection.*

IP phone also can be connected using VPN for secured communication instead of MRG feature.

Easy Installation even for VPN  
by Panasonic technology "VPSS".

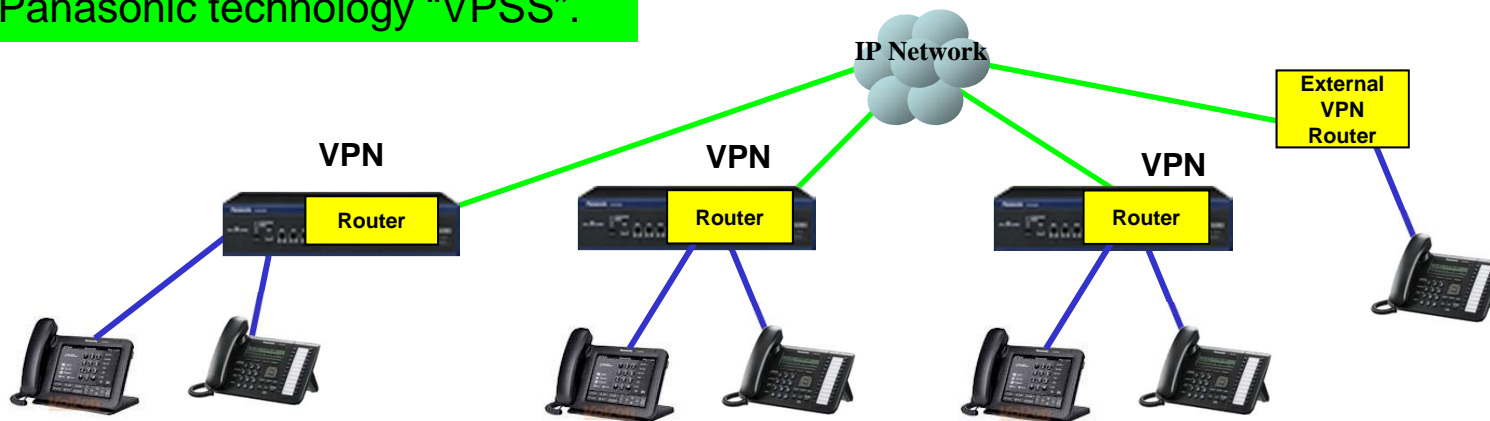

# Revision

Date	No.	Change
Aug 22, 2014	All	First release
Nov 5, 2014	2	KX-NS1000 version 4.1 supports 30-ch Built-in VM (UM).
Dec 1, 2014	61	For example, KX-NS1000 x 1 as master + KX-NS small PBX x 2 also can support 1,000 extensions.
	64	This condition (one UM = 10 Extension) is applied to KX-NS1000 only.
April 2, 2015		Version 4.1 supports 12 KX-TDA(E) and NCP.
		Version 4.2 supports KX-HDV IP phone using KX-NSM5xx AK. (Same AK for KX-NT/UT)

**KX-NS1000**

**Activation Key ( Master / Slave )**



## Activation Key List - 1

Model No.	Activation Key Type	One-look Network	
		Master Unit	Slave Unit
KX-NSE101	Cellular Phone Extension for 1 User	✓	-
KX-NSE105	Cellular Phone Extension for 5 Users	✓	-
KX-NSE110	Cellular Phone Extension for 10 Users	✓	-
KX-NSE120	Cellular Phone Extension for 20 Users	✓	-
KX-NSM005	Up to 50 IP Phone Capacity	✓	✓
KX-NSM010	Up to 100 IP Phone Capacity	✓	✓
KX-NSM030	Up to 300 IP Phone Capacity	✓	✓
KX-NSM099	Up to System Limit IP Phone Capacity	✓	✓
KX-NSM102	2-Channel IP Trunk	✓	✓
KX-NSM104	4-Channel IP Trunk	✓	✓
KX-NSM108	8-Channel IP Trunk	✓	✓
KX-NSM116	16-Channel IP Trunk	✓	✓

## Activation Key List - 2

Model No.	Activation Key Type	One-look Network	
		Master Unit	Slave Unit
KX-NSM201	1-Channel IP Softphone/IP PT	✓	✓
KX-NSM205	5-Channel IP Softphone/IP PT	✓	✓
KX-NSM210	10-Channel IP Softphone/IP PT	✓	✓
KX-NSM220	20-Channel IP Softphone/IP PT	✓	✓
KX-NSM501	1-Channel IP PT	✓	✓
KX-NSM505	5-Channel IP PT	✓	✓
KX-NSM510	10-Channel IP PT	✓	✓
KX-NSM520	20-Channel IP PT	✓	✓
KX-NSM701	1-Channel SIP Extension	✓	✓
KX-NSM705	5-Channel SIP Extension	✓	✓
KX-NSM710	10-Channel SIP Extension	✓	✓
KX-NSM720	20-Channel SIP Extension	✓	✓
KX-NSN001	One-look Network	✓	✓
KX-NSN002	QSIG Network	✓	-

## Activation Key List - 3

### Activation Key for Unified Messaging

Model No.	Activation Key Type	One-look Network	
		Master Unit	Slave Unit
KX-NSU001	UM Recording Time Expansion	✓	✓
KX-NSU002	Two-way Recording Control	✓	✓
KX-NSU003	UM Message Backup	✓	✓
KX-NSU102	2-Channel UM (2 UM Port)	✓	✓
KX-NSU104	4-Channel UM (4 UM Port)	✓	✓
KX-NSU201	IMAP4 and E-mail Notification for 1 User	✓	✓
KX-NSU205	IMAP4 and E-mail Notification for 5 Users	✓	✓
KX-NSU210	IMAP4 and E-mail Notification for 10 Users	✓	✓
KX-NSU220	IMAP4 and E-mail Notification for 20 Users	✓	✓
KX-NSU299	IMAP4 and E-mail Notification for All Users	✓	✓
KX-NSU301	Two-way Recording for 1 User	✓	-
KX-NSU305	Two-way Recording for 5 Users	✓	-
KX-NSU310	Two-way Recording for 10 Users	✓	-
KX-NSU320	Two-way Recording for 20 Users	✓	-
KX-NSU399	Two-way Recording for All Users	✓	-

## Activation Key List - 4

### Activation Key for CA/CTI

Model No.	Activation Key Type	One-look Network	
		Master Unit	Slave Unit
KX-NSA010	CA Thin Client Server Connection	✓	-
KX-NSA020	Multiple CSTA Connection	✓	-
KX-NSA201	CA Pro 1 user	✓	-
KX-NSA205	CA Pro 5 users	✓	-
KX-NSA210	CA Pro 10 users	✓	-
KX-NSA240	CA Pro 40 users	✓	-
KX-NSA249	CA Pro 128 users	✓	-
KX-NSA301	CA Supervisor	✓	-
KX-NSA401	CA Operator Console	✓	-
KX-NSA901	CA Network Plug-in for 1 User	✓	-
KX-NSA905	CA Network Plug-in for 5 Users	✓	-
KX-NSA910	CA Network Plug-in for 10 Users	✓	-
KX-NSA940	CA Network Plug-in for 40 Users	✓	-
KX-NSA949	CA Network Plug-in for 128 Users	✓	-
KX-NSF101	Activation Key for CTI interface (CTI interface)	✓	-

# TDE V6

# Feature List

No.	Feature List
1	New KX-TDA6179 - SLT 24-port card with message & caller ID for KX-TDE600
2	Hotel numbering plan - Duplicated extension number such as 3 and 301

# 1. Message & Caller ID SLT Card

Hospitality

SLT Card	Specifications		
Model	Port	Message	Caller ID
KX-TDA0173	8	No	Option
KX-TDA0174	16	No	No
KX-TDA0175	16	Yes	No
KX-TDA0177	16	No	Yes
KX-TDA6174	16	No	No
KX-TDA6175	16	Yes	No
<b>KX-TDA6178</b>	<b>24</b>	<b>No</b>	<b>Yes</b>
<b>KX-TDA6179</b>	<b>24</b>	<b>Yes</b>	<b>Yes</b>
KX-TDA1176	16	Yes	Yes
KX-TDA1178	24	Yes	Yes

PBX Compatibility				
TDA 100D	TDA 100 200	TDE 100 200	TDA 600	<b>TDE600</b>
No	Yes	Yes	Yes	<b>Yes</b>
No	Yes	Yes	No	<b>No</b>
No	Yes	Yes	No	<b>No</b>
No	Yes	Yes	Yes	<b>Yes</b>
No	No	No	Yes	<b>Yes</b>
No	No	No	Yes	<b>Yes</b>
<b>No</b>	<b>No</b>	<b>No</b>	<b>Yes</b>	<b>Yes</b>
<b>No</b>	<b>No</b>	<b>No</b>	<b>No</b>	<b>Yes</b>
Yes	No	Yes w/ MEC	No	<b>No</b>
Yes	No	Yes w/ MEC	No	<b>No</b>

## 2.1 Reserved Bit ( TDE @ NS Series )

Bit	Feature	<input type="checkbox"/> : Disable (Default)	<input checked="" type="checkbox"/> : Enable
0E-2	2. Hotel numbering plan	Disable.	Enable this.

\*) System restart (Power off and on) is required for Bit E-2.

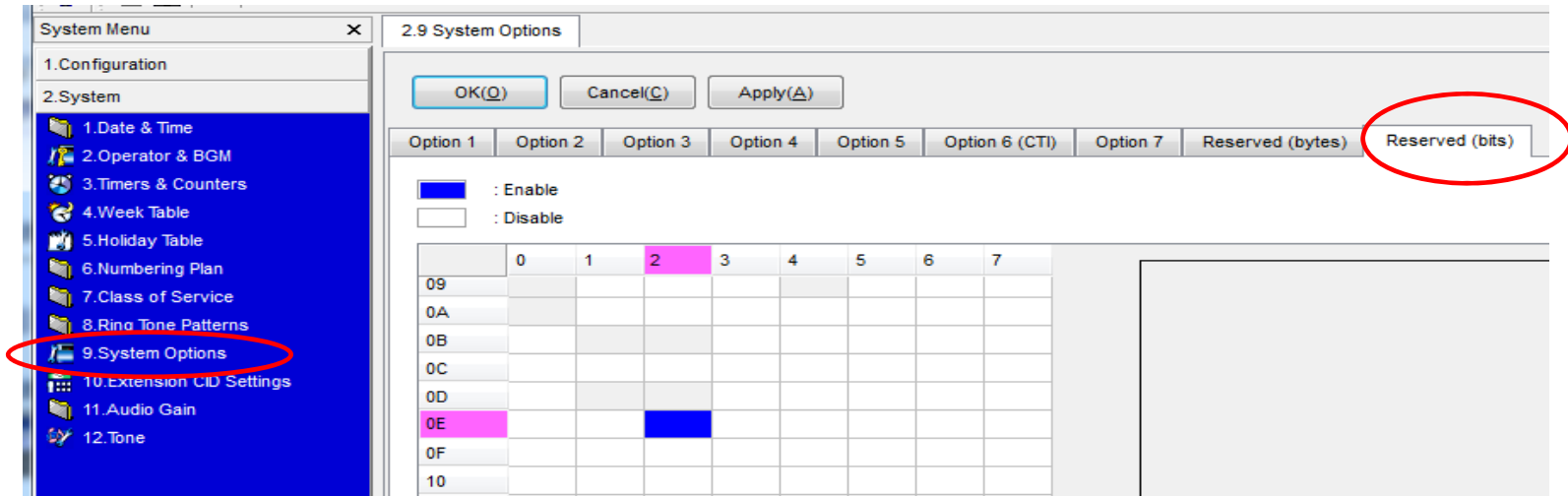



## 2-3 Timer & Counter

### Conditions

Timer can be adjusted.  
5 sec is recommended.  
4 sec is too short for other feature number  
such as wake-up call setting.

Dial

Hot Line (Pickup Dial) Start (s) :	1
Extension First Digit (s) :	250
Extension Inter-digit (s) :	10
Analogue CO First Digit (s) :	10

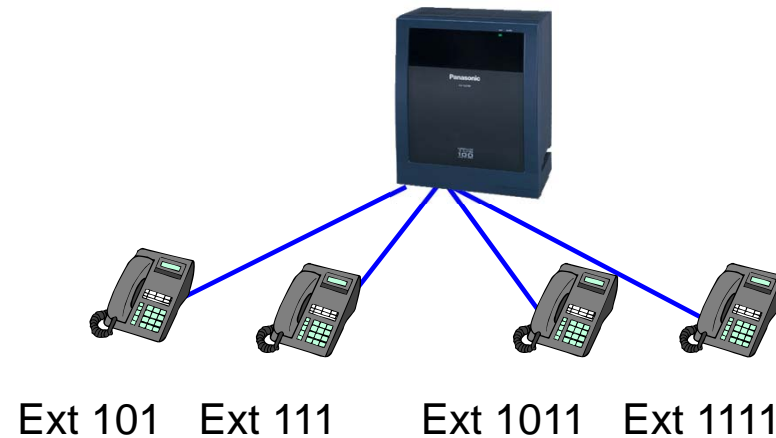
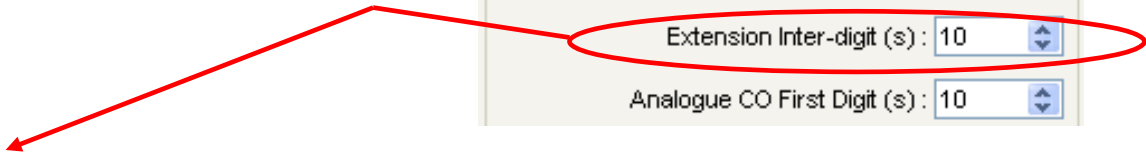

# 2.3 Hotel Numbering Plan

## 2- 6 – 1 Main

2.9 System Options    2.6.1 Main

OK(O)    Cancel(C)    Apply(A)

Extension    Features    Other PBX Extension    KX-T7710

-	No.	Feature	Leading Number (3 digits)	No. of Additional Digits
	19	Extension Numbering Scheme 19	28	XX
	20	Extension Numbering Scheme 20	29	XX
	21	Extension Numbering Scheme 21	5	XX
	22	Extension Numbering Scheme 22	6	XX
	23	Extension Numbering Scheme 23		XX
	24	Extension Numbering Scheme 24	3	None
	25	Extension Numbering Scheme 25	3	X
	26	Extension Numbering Scheme 26	3	XX
	27	Extension Numbering Scheme 27	30	XX
	28	Extension Numbering Scheme 28	31	XX
	29	Extension Numbering Scheme 29		XX
	30	Extension Numbering Scheme 30		XX

# 3. Trunk Group Access Order For ARS

Other Improve

Trunk group access order can be programmed for ARS carrier.

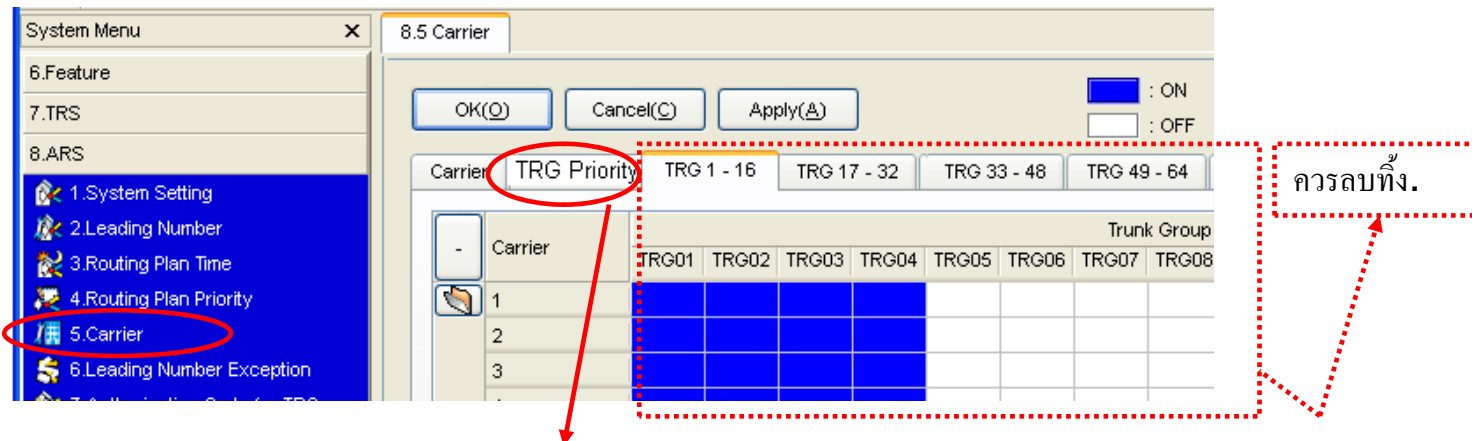

New parameter is added.  
 - Max.4 priority.  
 - Default is None.

Carrier	Priority 1	Priority 2	Priority 3	Priority 4
1	7	3	None	None
2	None	None	None	None
3	None	None	1	None
4	None	None	2	None
5	None	None	3	None
6	None	None	4	None
7	None	None	5	None
8	None	None	6	None
9	None	None	7	None

- <Programming Example>
- TRG7 for Priority 1
  - TRG3 for Priority 2
  - None for Priority 3 and 4
  - TRG1-4 on current parameter

Result of priority is as follows.  
 TRG7 > TRG3 > TRG1 > TRG2 > TRG4

# 4. ARS For Tenant ( V5 )

<Programming Solution – Step 1> using version 5 improvement  
 ARS routing plan 1 can be selected for any dial from tenant 1 and  
 ARS routing plan 2 can be selected for any dial from tenant 2.

Leading digits are applied as follows when ARS is enabled by tenant.

Tenant Number	Music On Hold	Operator (Extension)	ARS Mode
1	Same as Syst...		On for Local Access Operation
2	Same as Syst...		On for Local Access Operation
3	Same as Syst...		Same as System Setting
4	Same as Syst...		Off
5	Same as Syst...		Same as System Setting

Tenant	1	2	...	20	21 or more
Leading Digits	1-50	51-100	...	951-1000	1-1000

No.	Leading Number	Additional Number	Routing Plan Number
1	X	0	1
2		0	1

No.	Leading Number	Additional Number	Routing Plan Number
51	X	0	2
52		0	1

# 5. ARS Carrier Increase

Other Improve

ARS carrier is increased.

PBX	Version 5	Version 6
NCP TDE100 TDE200	10 carrier	48 carrier
TDE600	48 carrier	48 carrier

Carrier					
TRG 1 - 16					
TRG 17 - 32					
TRG 33 - 48					
TRG 49 - 64					
TRG 65 - 80					
TRG 81 - 96					
-	Carrier	Carrier Name	Removed Number of Digits	Modify Command	Carrier Access Code
	27		0	CH	
	28		0	CH	
	29		0	CH	
	30		0	CH	
	31		0	CH	
	32		0	CH	
	33		0	CH	
	34		0	CH	
	35		0	CH	
	36		0	CH	
	37		0	CH	
	38		0	CH	
	39		0	CH	
	40		0	CH	
	41		0	CH	
	42		0	CH	
	43		0	CH	
	44		0	CH	
	45		0	CH	
	46		0	CH	
	47		0	CH	
	48		0	CH	

# TDE Ver 7

# 1.1 Call Log for Extension Call

Version 7  
for PT

Outgoing call log and redial are available for extension call also by programming.

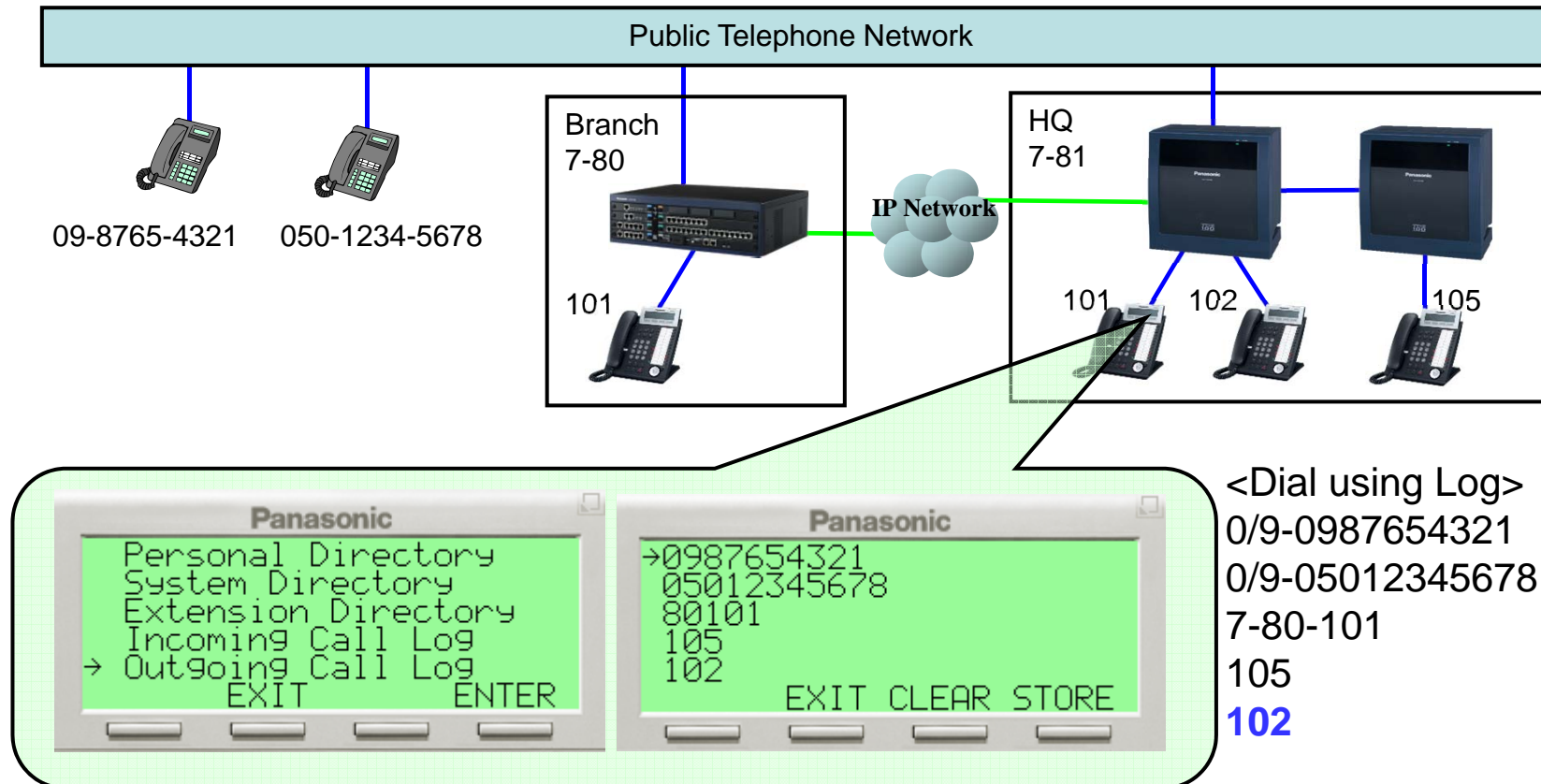

**102** can be saved newly using TDE-NCP version 7.  
Other dials are saved using TDE-NCP any version.

“Store” works for  
extension call also.

# 1.2 Call Log for Extension Call

Version 7  
for PT

Incoming call log is available for extension call also by programming.

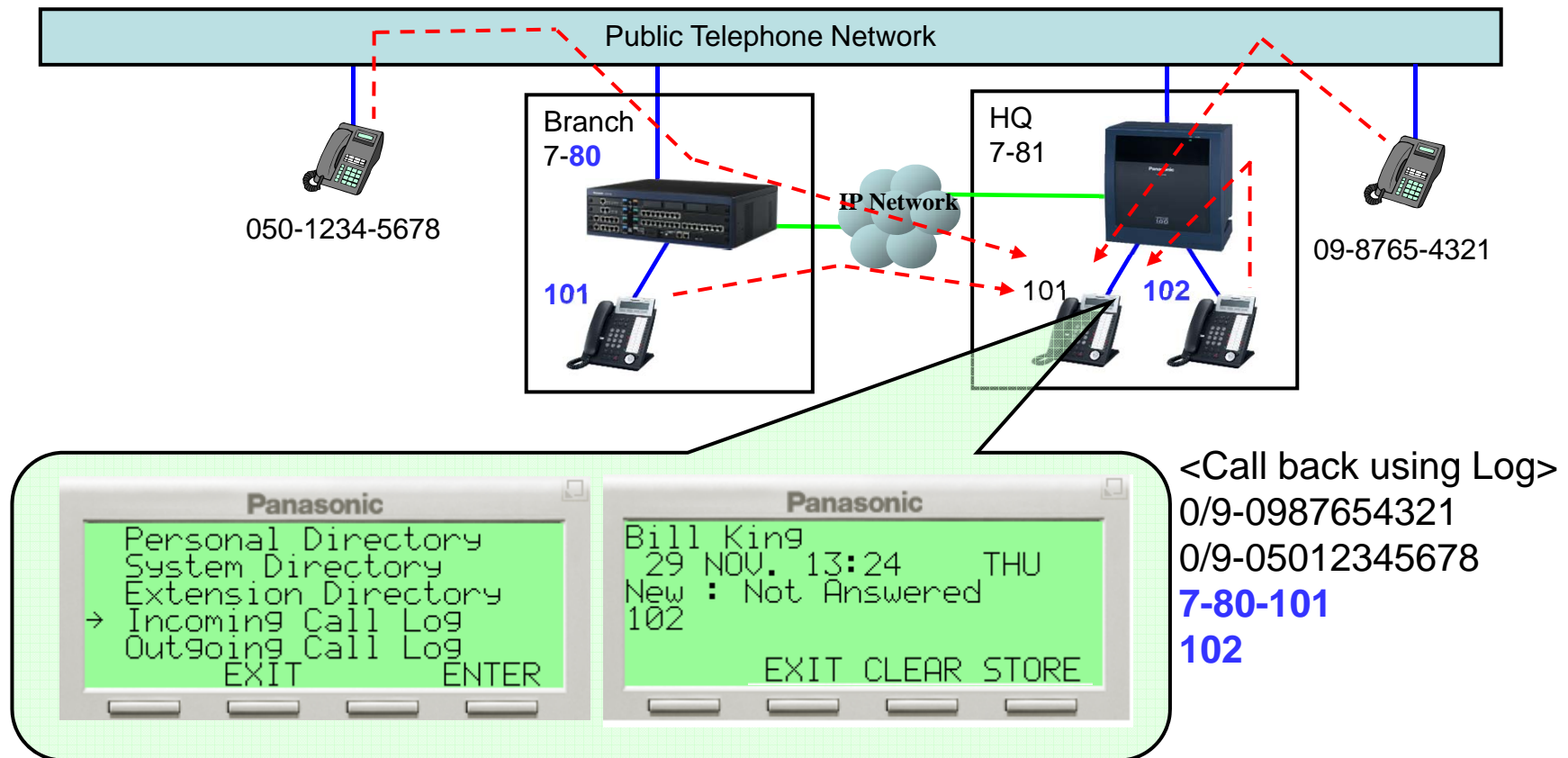

**102** and **80101** can be saved newly using TDE-NCP version 7.  
Other dials are saved using TDE-NCP any version.



# 1.3 Call Log for Extension Call

Version 7  
for PT

## Programming

- This feature is enabled for incoming call and outgoing call separately using system optional programming.
- Default is “Enable”.
- Specification of “Disable” is same as TDE-NCP version 6 or before.

2.9 System Options

OK(O) Cancel(C) Apply(A)

Option 1 Option 2 Option 3 Option 4 Option 5 Option 6 (CTI) Option 7

Incoming Call Log

Busy/Intercept (when Called Party is Busy)

Enable (Not Answered)  Disable

Fwd All/Fwd Busy

Enable (Not Answered)  Disable

Call Pickup

Answered  Not Answered

Extension/TIE Call

Enable  Disable

Outgoing Call Log

Extension Call

Enable  Disable

# 1. Call Log for Extension Call

Version 7  
for PT

## Condition

- When outgoing call log is available for extension call, old same phone number is deleted from outgoing call automatically. This is applied to both extension call and trunk call.

TDE-NCP version 7

Outgoing Call Log :

Enable for Extension Call

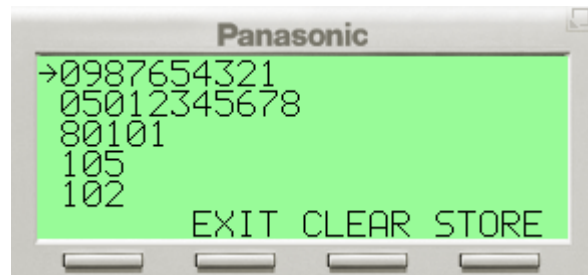

↓ If call 105, old 105 is deleted.  
Other dials are kept.

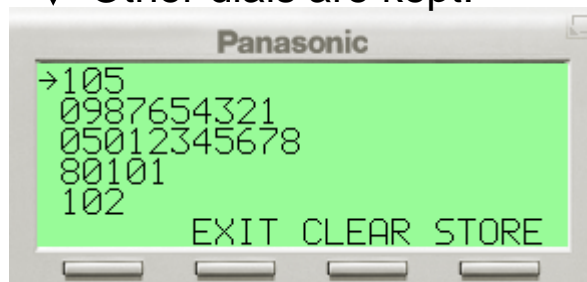

TDE-NCP version 7

Outgoing Call Log :

Disable for Extension Call

or

TDE-NCP version 6 or before

=> Same number is logged.

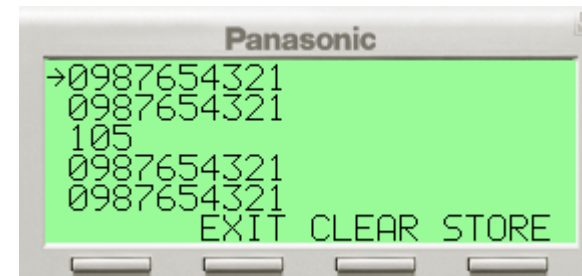

# 2. Tenant Extension Directory

Extension directory can be limited for same tenant user only by programming.



**Panasonic**  
Personal Directory  
System Directory  
→ Extension Directory  
Incoming Call Log  
Outgoing Call Log  
EXIT    ENTER

**Panasonic**  
→Ann  
Bill  
Catherine  
Diana  
Elizabeth  
VIEW    EXIT    PREV    NEXT

**Panasonic**  
→Andrew  
Ann  
Bill  
Catherine  
Charles  
VIEW    EXIT    PREV    NEXT

Extension Directory does NOT display Andrew and Charles, when limitation is activated.

Extension Directory displays Andrew and Charles also, when limitation is NOT activated.

# 2. Tenant Extension Directory

## Programming

- This feature is enabled using tenant programming.
  - All Tenant : Can see directory of all extension  
(Default : Same as TDE/NCP version 6)
  - Each Tenant : Can see directory of extension in same tenant only

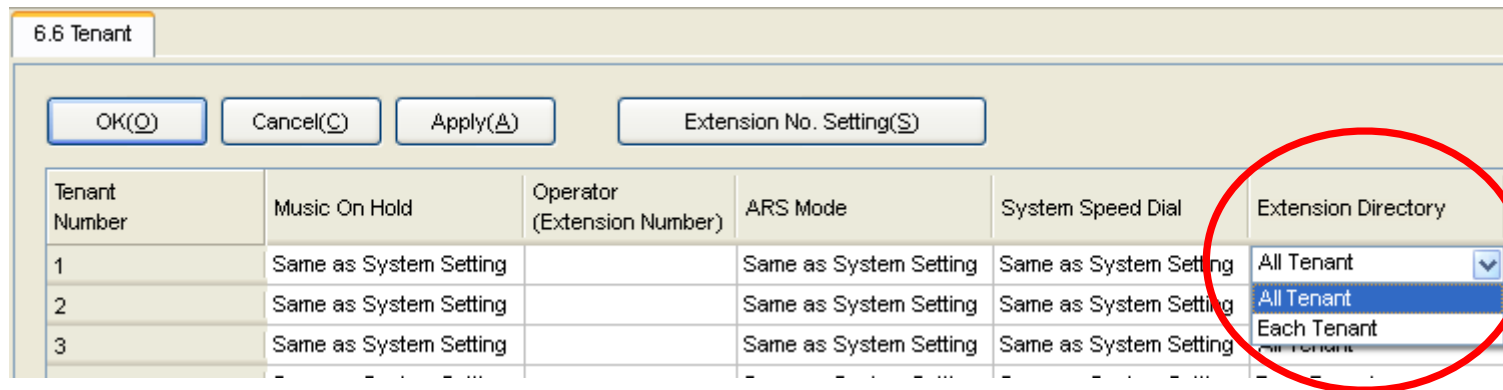

# TDE Ver 8.

# 1. Feature List for KX-TDE/NCP Version 8

No.	Feature
1	New Digital PT <a href="#">KX-DT546/DT543/DT521</a> is supported. New DSS Console <a href="#">KX-DT590</a> is also supported. <i>*) Software of DLC/DHLC card has to be <a href="#">version 8</a>.</i>
2	New IP PT <a href="#">KX-NT556/NT553/NT551</a> and <a href="#">KX-NT511</a> are supported. New DSS Console <a href="#">KX-NT505</a> is also supported. <i>*) These phones have to be registered to MPR card. These phones cannot be registered to IP-EXT16 card.</i>
3	New CO cards <a href="#">KX-TDA6381</a> and <a href="#">KX-TDA6382</a> are supported for <a href="#">KX-TDE600</a>

## 2. Reference for KX-TDA

No.	Feature
1	New Digital PT <a href="#">KX-DT546/DT543/DT521</a> is supported. New DSS Console <a href="#">KX-DT590</a> is also supported. <i>*) Software of DLC/DHLC card has to be <a href="#">version 8</a>.</i>
2	New CO cards <a href="#">KX-TDA6381</a> and <a href="#">KX-TDA6382</a> are supported for <a href="#">KX-TDA600</a> .

### 3. New CO Card for KX-TDE600 and KX-TDA600

New CO cards [KX-TDA6381](#) and [KX-TDA6382](#) are supported for KX-TDE600/620 and KX-TDA600/620.

ECLCOT16	KX-TDA6181 (Current model)	<a href="#">KX-TDA6381</a> (New model)	<a href="#">KX-TDA6382</a> (New Model)
Port	16-port	16-port	16-port
Caller ID	using KX-TDA193 (or 189)	N/A (No Option)	<a href="#">Built-in for 16-port</a>
Pay Tone	using KX-TDA189	N/A (No Option)	N/A (No Option)
Card Software	Version 2	Version 3	Version 3

These cards can be used also when KX-TDE600/620 or KX-TDA600/620 is connected with KX-NS1000.



# 4. SLT Card Software Improvement

แก้ไข SLT port with caller ID หน่วยงาน กระตั้ง.

KX-TDA1176 (16-port)	for KX-TDA100D and KX-TDE100-200
KX-TDA1178 (24-port)	and KX-NS1000
KX-TDA6178 (24-port w/o Message)	for KX-TDA600, KX-TDE600 and KX-NS1000
KX-TDA6179 (24-port)	for KX-TDE600 and KX-NS1000

Case	Card Software	Caller ID setting	Result
1	Version 4 Version 5	Disable	→ Pre-ring works
2	Version 4	Enable	→ Pre-ring does NOT work.
3	Version 5	Enable	→ Pre-ring works newly.

Case 3 is quicker than case 2 to start ringing.

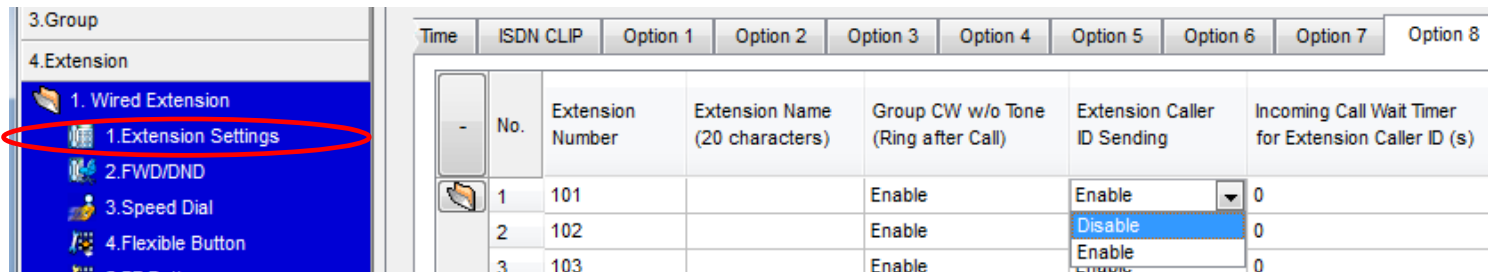

# การโปรแกรมเพิ่มเติม

# Timed Reset ( NS Series ) V 4.2



Utility – 2. System Control 3 . System Reset – Timed Reset

System Reset

System Reset Timed Reset

Reset Mode : None  
Reset Time :

None  
One Time  
Daily

OK Cancel Apply

# Tie Line / GW H323

# Programming – 1.1

The screenshot shows the '2.9 System Options' window in the KX-TDE Maintenance Console. The 'System Menu' on the left has '9. System Options' selected. In the main window, 'Option 4' is highlighted with a red circle. Below it, the 'TIE Call by Extension Numbering (Activation Key Required)' option is set to 'Enable' and is also highlighted with a red box. An inset table shows the number of activated features by card type, with 'Enhanced Features' highlighted in red. A pink box at the bottom right lists the required activation keys for different models.

Activated Feature	The number of activated feature by		
	VolIP-DSP Card	Activation Key File in SD Card	Total
IP Trunk (ch)	4	12	16
IP Proprietary Telephone (ch)	8	24	32
IP Proprietary Telephone / IP Softphone (ch)	0	64	64
SIP Extension (ch)	0	48	48
Enhanced Features	0	1	1
CA Basic (user)	10	256	266

Activation Key (Enhanced Feature)  
 KX-NCS3910 for NCP500-1000  
 KX-NCS4910 for TDE100-200  
 KX-NCS4950 for TDE600

This programming is not required because default is enabled. Activation key is required. If dialed number is in “Numbering Plan for Extension” but it is NOT extension number in this PBX, TIE feature works.

# Programming – 1.2

Option 1 | Option 2 | Option 3 | **Option 4** | Option 5 | Option 6 (CTI)

**DSS key mode for Incoming Call**  
 On or Flash       Off

**Call Pick-up by DSS key for Direct Incoming Call**  
 Enable       Disable

**Call Pick-up by DSS key for ICD Group Call**  
 Enable       Disable

**Automatic Transfer for Extension Call**  
 Enable       Disable

**Caller Information Display before Call Pick-up**  
 Enable       Disable

**Private Network**

**Public Call through Private Network**

Minimum Public Caller ID Digits : 9

**TIE Call by Extension Numbering**  
 Enable       Disable

NS series ไม่ต้องใช้ AK

# Programming – 1.3

KX-TDE Maintenance Console - [2. System - 6. Numbering Plan - 1. Main]

File(F) Disconnect(D) Tool(T) Utility(U) View(V) Window(W) Help(H)

System Menu x 2.6.1 Main

1. Configuration  
2. System  
4. Week Table  
5. Holiday Table  
6. Numbering Plan  
1. Main  
2. Quick Dial  
3. Group  
4. Extension  
5. Optional Device  
6. Feature  
7. TRS  
8. ARS  
9. Private Network  
10. CO & Incoming Call  
11. Maintenance

OK(O) Cancel(C) Apply(A)

Extension Features Other PBX Extension KX-T7710

No.	Feature	Leading Number (3 digits)	No. of Additional Digits
1	Extension Numbering Scheme 01	1	XX
2	Extension Numbering Scheme 02	2	XX
3	Extension Numbering Scheme 03	3	XX
4	Extension Numbering Scheme 04	4	XX
5	Extension Numbering Scheme 05		XX
6	Extension Numbering Scheme 06		XX
7	Extension Numbering Scheme 07		XX
8	Extension Numbering Scheme 08		XX
9	Extension Numbering Scheme 09		XX
10	Extension Numbering Scheme 10		XX
21	Extension Numbering Scheme 21	5	XX
22	Extension Numbering Scheme 22	6	XX

Batch Mode: Type : TDE200 Le

KX-TDE Maintenance Console - [9. Private Network - 1. TIE Table]

File(F) Disconnect(D) Tool(T) Utility(U) View(V) Window(W) Help(H)

System Menu x 2.6.1 Main 4.1.1 Extension Settings 9.1 TIE Table

1.Configuration  
2.System  
3.Group  
4.Extension  
5.Optional Device  
6.Feature  
7.TRS  
8.ARS  
9.Private Network  
10.CO & Incoming Call  
11.Maintenance

1. TIE Table  
2. Network Data Transmission  
3. Network Operator (VoIP)  
4. NDSS Key Table

OK(O) Cancel(C) Apply(A)

Own PBX Code (7 digits)

Priority 1 - 2 Priority 3 - 4 Priority 5 - 6 Priority 7 - 8 Enhanced QSIG

No.	Leading Number (3 digits)	Priority 1			Priority 2		
		Removed Number of Digits	Added Number (32 digits)	Trunk Group	Removed Number of Digits	Added Number (32 digits)	Trunk Group
1	1	0		7	0		None
2	2	0		7	0		None
3	3	0		7	0		None
4	4	0		7	0		None
5	5	0		7	0		None
6	6	0		7	0		None
7	7	0		7	0		None
8	8	0		7	0		None
9	9	0		7	0		None
10	0	0		7	0		None
11		0		None	0		None

Batch Mode: Type : TDE200 Level : Installer Version005-000 Region006-017



# Programming – 1.5

System Menu

- 1. Configuration
- 2. System
- 3. Group
- 4. Extension
- 5. Optional Device
- 6. Feature
- 7. TRS
- 8. ARS
- 9. Private Network
- 10. CO & Incoming Call
  - 1. CO Line Settings**
  - 2. DIL Table & Port Settings
  - 3. DDI / DID Table
- 11. Maintenance

CO Line Number	Shelf	Slot	Port	Card Type	CO Name (20 characters)	Trunk Group Number
26	Physical	1	1	PRI30		1
27	Physical	1	1	PRI30		1
28	Physical	1	1	PRI30		1
29	Physical	1	1	PRI30		1
30	Physical	1	1	PRI30		1
31	Virtual	1	1	V-IPGW16		7
32	Virtual	1	1	V-IPGW16		7
33	Virtual	1	2	V-IPGW16		7
34	Virtual	1	2	V-IPGW16		7
35	Virtual	1	3	V-IPGW16		7
36	Virtual	1	3	V-IPGW16		7
37	Virtual	1	4	V-IPGW16		7
38	Virtual	4	4	V-IPGW16		7

Batch Mode: Type : TDE200 Level : Installer Version005-000 Region006-017

Default of VoIP IP-GW (H.323) is Trunk Group 7.  
Default of other trunk is Trunk Group 1.

# การโปรแกรม IP-GW ( NS300 )



## PBX ConFig- 1. Configuration - 1. Slot - Activation Key

**ออกแบบจำนวน Ch ของ IP-GW**

MPR-ID : F5010900F04D525C

Number of activated IP-Softphone : 0 / 0

Number of activated IP-GW : 4 / 8

Activate Pre-installed Activation keys

Activated feature	Pre-installed	Activation key	Features in total
IP Trunk (ch)	0	8	8
IP Proprietary Telephone/IP Softphone (ch)	0	0	0
IP Proprietary Telephone (ch)	4	16	20
SIP Extension (ch)	0	14	14
QSIG Network	0	0	0

# Virtual IP Card ( NS300 )

Virtual IP Card for	Capacity
Trunk (SIP or H.323 )	4-ch x 4-card
Extension (KX-NT or KX-UT or SIP)	8-ch x 4-card

The screenshot displays the configuration interface for a Panasonic KX-NS300 system. The left sidebar shows a navigation menu with '1. Slot' selected. The main area is titled 'Slot' and contains several tabs: 'System Property', 'Activation Key', 'IP Phone Registration', 'VoIP Property', and 'UM Property'. Below these tabs, there are three main sections:

- Trunk Slot Card:** Contains two slots labeled 'V-SIPGW4' and 'V-IPGW4'.
- Extension Slot Card:** Contains three slots labeled 'V-IPEXT8', 'V-SIPEXT8', and 'V-UTEEXT8', and one slot labeled 'V-IPCS4'.
- Virtual IP Card Rack:** A rack with 12 slots, divided into three columns:
  - Column 1 (Slots 1-4):** Labeled 'Trunk'. Slots 1 and 2 contain 'V-SIPGW4' cards, and slots 3 and 4 are empty.
  - Column 2 (Slots 5-8):** Slots 5, 6, and 7 contain 'V-IPEXT8', 'V-SIPEXT8', and 'V-UTEEXT8' cards respectively. Slot 8 is empty.
  - Column 3 (Slots 9-12):** Labeled 'IP-CS'. Slot 9 contains a 'V-IPCS4' card, and slots 10, 11, and 12 are empty.

# การโปรแกรม IP-GW ( NS300 )



## PBX ConFig- 1. Configuration - 1. Slot - Virtual Slot - OUS

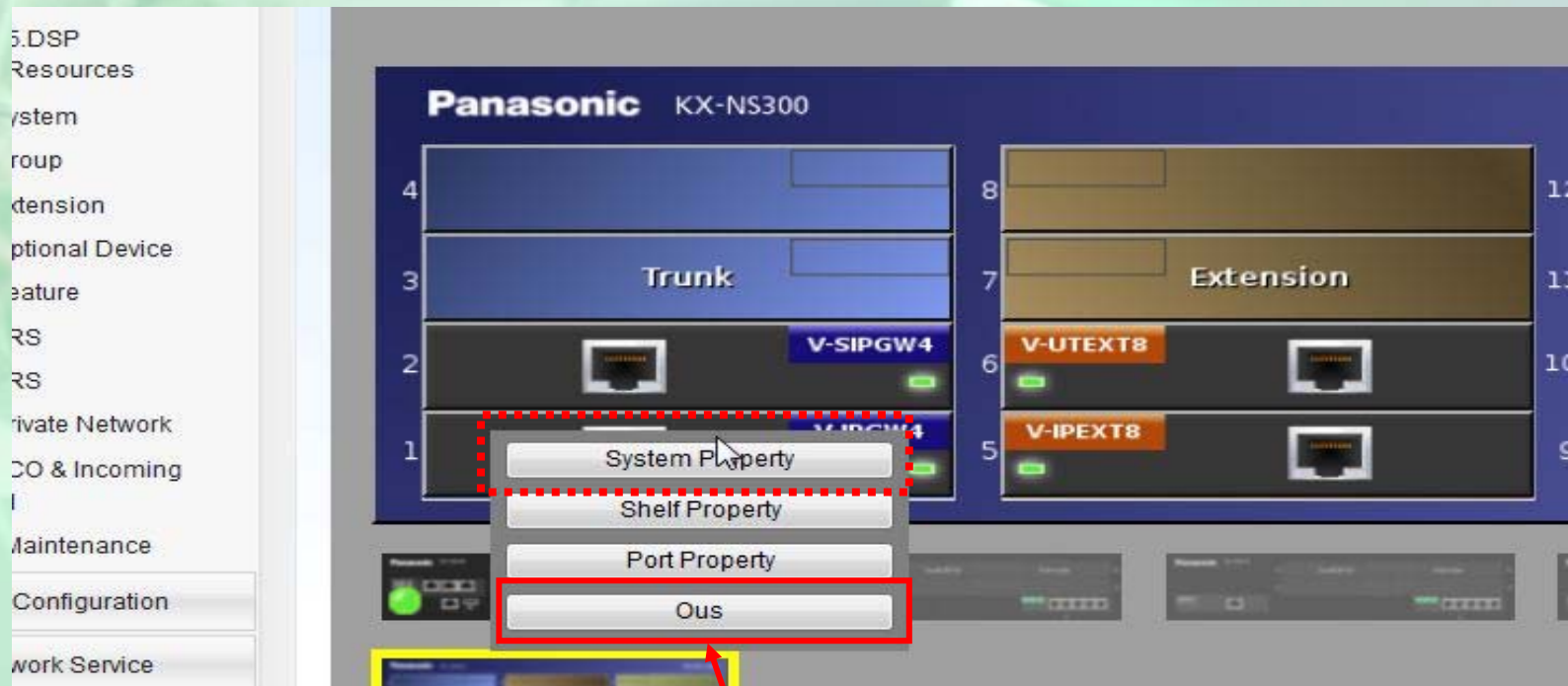

OUS Card IP-GW4 เพื่อกำหนดค่าต่าง ๆ / เมื่อกำหนดเรียบร้อยแล้วให้ INS

# การโปรแกรม IP-GW ( NS300 )



## **PBX ConFig- 1. Configuration - 1. Slot -Virtual Slot-System Property - V-IPGW - GW Setting**

System Property - Main - V-IPGW - GW Settings

Main Option 1 Option 2 Option 3

No.	GW Name (20 characters)	GW IP Address	GW Group	Connection for IP-GW	Protocol
			ALL	ALL	ALL
1	Head office TDE	192.168.0.209	None	Disable(TDE/NCP)	TCP
2	Branch 1 NS300	192.168.0.101	None	Disable(TDE/NCP)	TCP
3	Branch 2 Ns1000	192.168.0.200	None	Disable(TDE/NCP)	TCP
4			None	Enable(TDA)	TCP
5			None	Enable(TDA)	TCP

**กำหนด IP Address ของแต่ละตู้สาขา ( Max = 512 )**



## PBX ConFig- 1. Configuration - 1. Slot -Virtual Slot-System Property - V-IPGW - GW Setting

System Property - Main - V-IPGW - GW Settings

Main Option 1 Option 2 Option 3

No.	GW Name (20 characters)	GW IP Address	GW Group	Connection for IP-GW	Protocol
			ALL	ALL	ALL
1	Head office TDE	192.168.0.209	None	Disable(TDE/NCP)	TCP
2	Branch 1 NS300	192.168.0.101	None	Disable(TDE/NCP)	TCP
3	Branch 2 Ns1000	192.168.0.200	None	Disable(TDE/NCP)	TCP
4			None	Enable(TDA)	TCP
5			None	Enable(TDA)	TCP

กำหนด IP Address ของแต่ละตู้สาขา ( Max = 512 )

# Virtual IP Card ( NS300 )



PBX ConFig- 1. Configuration – 1.Slot – Virtual Slot – System Property – V-IPGW

The screenshot displays the 'System Property - Main' configuration page. The left sidebar shows a tree view with '1.Slot' selected. The main area has tabs for 'Main', 'System Status', and 'V-IPGW'. Under 'V-IPGW', there are sub-tabs for 'GW Settings' and 'DN2IP'. The 'GW Settings' tab is active, showing the following configuration:

Call Signalling Model	: Direct
Gatekeeper Connection Checking Interval (*60s)	: 0
Terminal type to Gatekeeper	: Terminal
Gatekeeper ID to Gatekeeper	:
Bandwidth to Gatekeeper	: 10 kbps
Primary Gatekeeper IP Address	: 192.168.1.3
Primary Gatekeeper Port Number	: 1719

**เลือก GW Setting เพื่อ กำหนด IP Address ของแต่ละตู้สาขา**

KX-TDE Maintenance Console - [1. Configuration - 1. Slot]

File(E) Disconnect(D) Tool(T) Utility(U) View(V) Window(W) Help(H)

System Menu x 1.1 Slot

1. Configuration

- 1. Slot
- 2. Portable Station
- 3. Option
- 4. Clock Priority

2. System

3. Group

4. Extension

5. Optional Device

6. Feature

7. TRS

8. ARS

9. Private Network

10. CO & Incoming Call

11. Maintenance

Batch Mode: Type : TDE200 Level : Installer Version005-000 Region006-017

Refresh(E) Close(L) Summary(S) Activation Key(A)

IP Phone Registration(R)

IPCMPR Virtual Slot: 8

V-IPGW16

- V-IPEXT32
- V-SIPEXT32
- V-IPGW16
- V-SIPGW16
- V-IPCS4

Virtual 16-Channel VoIP Gateway Card

Shelf Property

Port Property

Ous

Trunk

Extension

1 2 3 4 5 6 7 8

Physical Slot

IPCMPR Virtual Slot

OUS Card ก่อน

Select "Shelf Property".



KX-TDE Maintenance Console - [1.Configuration - 1.Slot - Shelf Property - Virtual IP Gateway]

File(F) Disconnect(D) Tool(T) Utility(U) View(V) Window(W) Help(H)

System Menu x 1.1 Slot Shelf Property - Virtual IP Gateway

1.Configuration  
 1.Slot  
 2.Portable Station  
 3.Option  
 4.Clock Priority

2.System  
 3.Group  
 4.Extension  
 5.Optional Device  
 6.Feature  
 7.TRS  
 8.ARS  
 9.Private Network  
 10.CO & Incoming Call  
 11.Maintenance

OK(O) Cancel(C) Apply(A)

GK Settings(K) GW Settings(W) DN2IP(D) Hunt Pattern(H)

Main Outgoing Call Incoming Call Timer

Description	Value
Gatekeeper Available	Disable
Call Signalling Model	Direct
Gatekeeper Connection Checking Interval (*60s)	0
Primary Gatekeeper IP Address	192.168.1.3
Primary Gatekeeper Port Number	1719
Secondary Gatekeeper IP Address	192.168.1.4
Secondary Gatekeeper Port Number	1719
H.225 Port Number	1720
RAS Port Number	1719
QSIG Connectionless Tunneling TCP Port Number	1718

Batch Mode: Type: TDE200 Level: Installer Version: 005-000 Region: 006-017

The screenshot shows the 'KX-TDE Maintenance Console' window. The title bar indicates the current path: '1. Configuration - 1. Slot - Shelf Property - Virtual IP Gateway - GW Settings'. The 'GW Settings' tab is highlighted with a red circle. In the left-hand 'System Menu', '1. Slot' is also highlighted with a red circle. Below the menu, there are 'OK(O)', 'Cancel(C)', and 'Apply(A)' buttons. A 'Main' tab is selected, and a table displays gateway settings. A red box highlights the first three rows of the table.

No.	GW Name (20 characters)	GW IP Address	GW Group	Connection for IP-GW16	Protocol	Progress Ton Send Mode
1	PBX in Sydney	192.168.0.21	None	Enable(TDA)	TCP	Internal
2	PBX in Melbourne	192.168.0.31	None	Enable(TDA)	TCP	Internal
3	PBX in Perth	192.168.0.81	None	Enable(TDA)	TCP	Internal
4			None	Enable(TDA)	TCP	Internal
5			None	Enable(TDA)	TCP	Internal
6			None	Enable(TDA)	TCP	Internal
7			None	Enable(TDA)	TCP	Internal
8			None	Enable(TDA)	TCP	Internal
9			None	Enable(TDA)	TCP	Internal

Batch Mode: Type : TDE200 Level : Installer Version005-000 Region006-017

The screenshot shows the 'KX-TDE Maintenance Console' window. The 'System Menu' on the left has '1. Slot' selected. The main window is in the 'DN2IP' tab, displaying a table of configurations. A red box highlights the first five rows of the table. A callout box provides details for GW No. 1.

No.	Leading Number (30 digits)	Remaining Number of Digits	GW No/GW Group Selection	GW Group	GW No.
1	10	1	GW No	1	1
2	11	1	GW No	1	2
3	12	1	GW No	1	3
4	2	2	GW No	1	2
5	3	2	GW No	1	3
6		29	GW No	1	1
7		29	GW No	1	1
8		29			
9		29			
10		29			

No.	GW Name (20 characters)	GW IP Address
1	Sydney PBX	192.168.0.21
2	Melbourne PBX	192.168.0.31
3	Perth	192.168.0.81

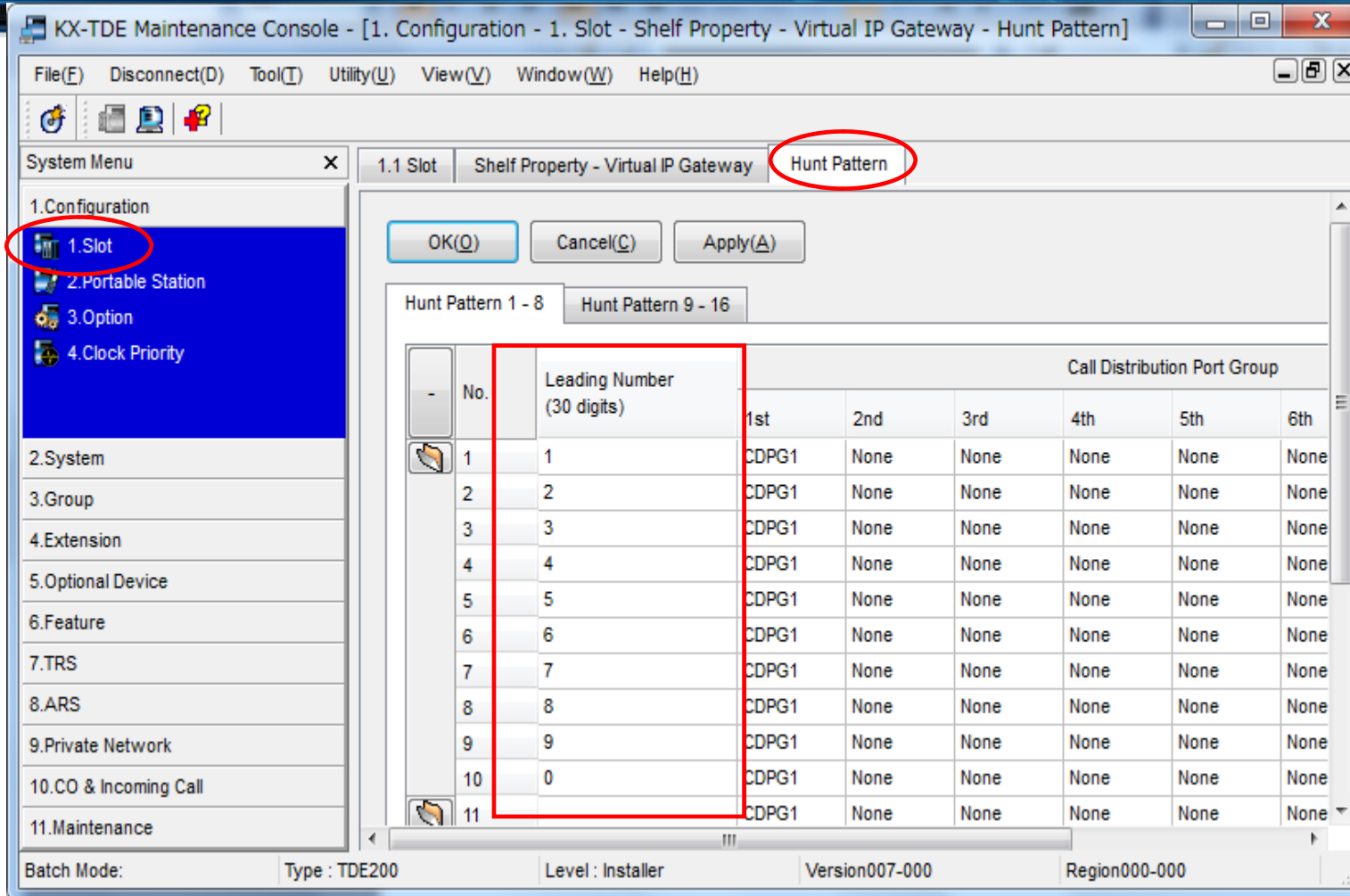

หากไม่มีกำหนดเลขได้ไว้ หมายเลขนั้นจะโทรเข้ามาไม่ได้

**KX-TDE Maintenance Console - [1. Configuration - 1. Slot]**

File(E) Disconnect(D) Tool(T) Utility(U) View(V) Window(W) Help(H)

System Menu x 1.1 Slot

1. Configuration

- 1. Slot
- 2. Portable Station
- 3. Option
- 4. Clock Priority

2. System

3. Group

4. Extension

5. Optional Device

6. Feature

7. TRS

8. ARS

9. Private Network

10. CO & Incoming Call

11. Maintenance

Batch Mode: Type : TDE200 Level : Installer Version005-000 Region006-017

Refresh(E) Close(L) Summary(S) Activation Key(A)

IP Phone Registration(R)

IPCMPR Virtual Slot: 8

V-IPEXT32  
V-SIPEXT32  
V-IPGW16  
V-SIPGW16  
V-IPCS4

Virtual 16-Channel VoIP Gateway Card

Trunk Extension

Shelf Property  
Port Property

**INS**

INS Card

Physical Slot IPCMPR Virtual Slot

# Programming – 1.12

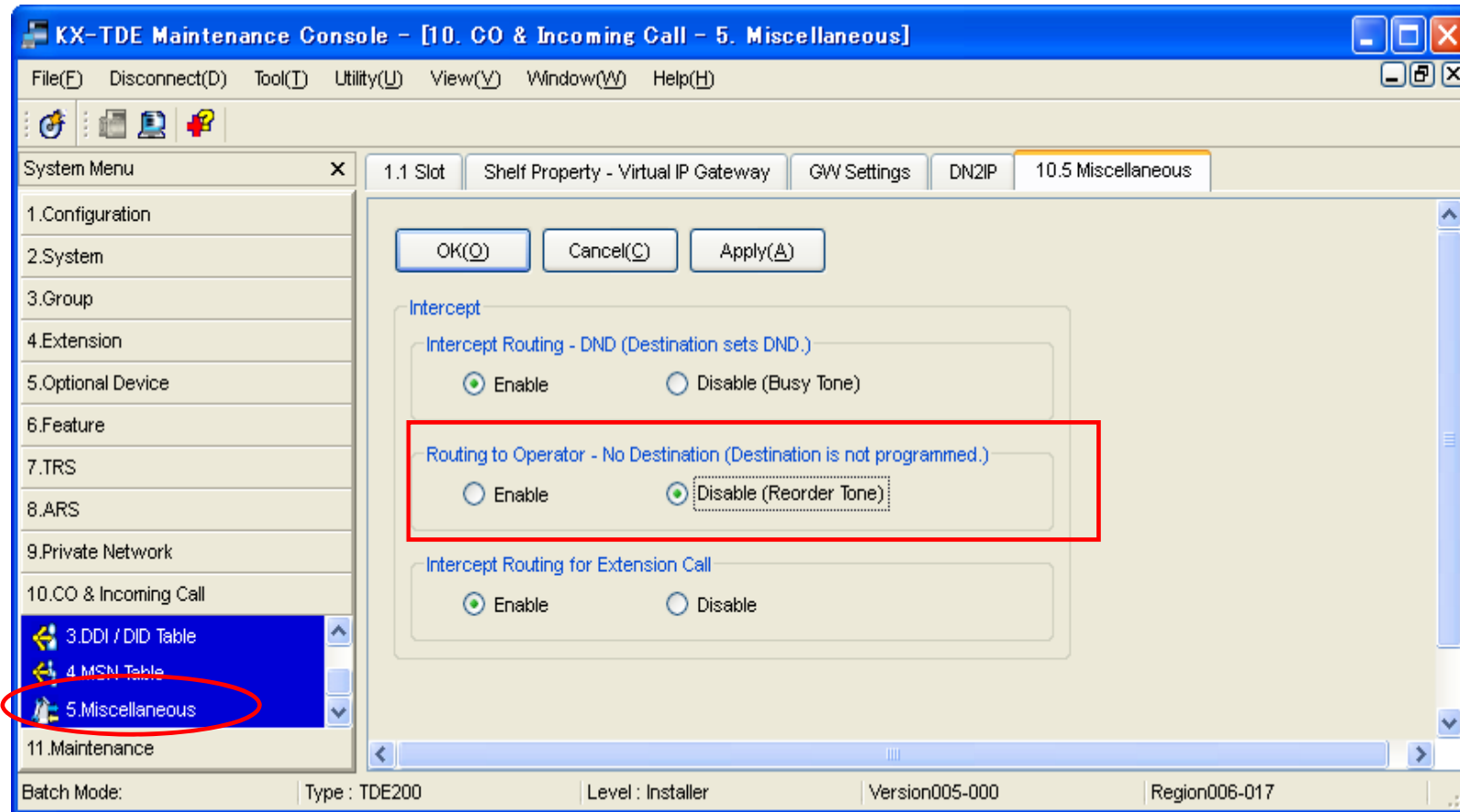

# การ โปรแกรม One look

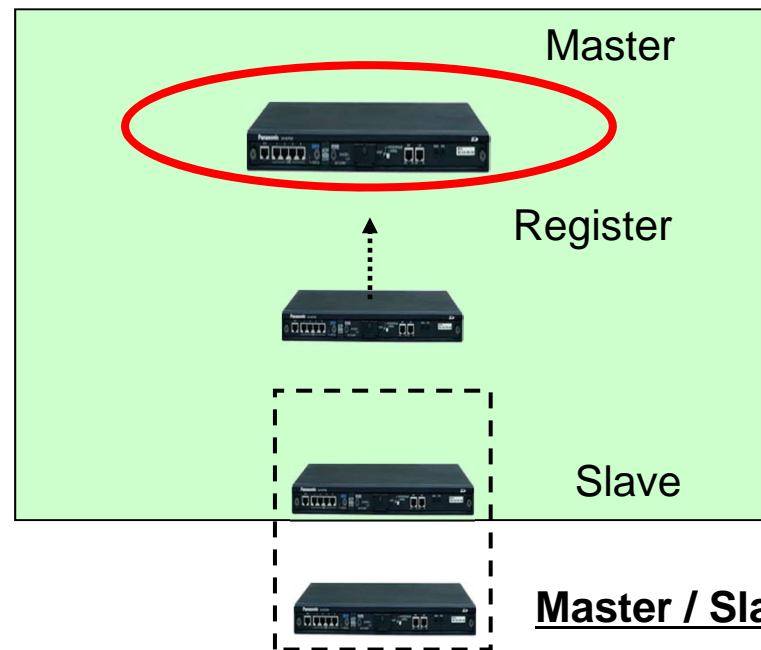

**Master / Slave** ต้องเป็น **Version** เดียวกัน

# 1. Add Site

Master Unit

The screenshot displays the NS1000 Web Maintenance Console interface. At the top, the title bar reads "NS1000 Web Maintenance Console" and includes navigation icons. Below the title bar, the user is logged in as "INSTALLER". The main area shows a network topology with a central "NS1000" Master Unit (represented by a large blue and green building icon) connected to three horizontal rows of five smaller building icons representing sites. A red dashed arrow points from a yellow callout box containing the Thai text "เลือกเพิ่ม สาขา" (Select Add Branch) to a green plus sign icon in the top right corner of the interface, which is highlighted with a red square. The footer of the console contains the copyright notice: "© Panasonic System Networks Co., Ltd. 2011-2012".



# 1.2. Add Site Wizard

Master  
Unit

### Add Site Wizard

- 1 Location Setting
- 2 PBX Setting**
- 3 LAN Setting
- 4 Registration Setting
- 5 SNTP / Daylight Saving
- 6 Maintenance Setting

#### PBX Setting

Site name (1-32 characters):

Time Zone:  :

Local Time:

# 1.3. Add Site Wizard

Master  
Unit

1. (Programming is not required.)
2. Click [Next].

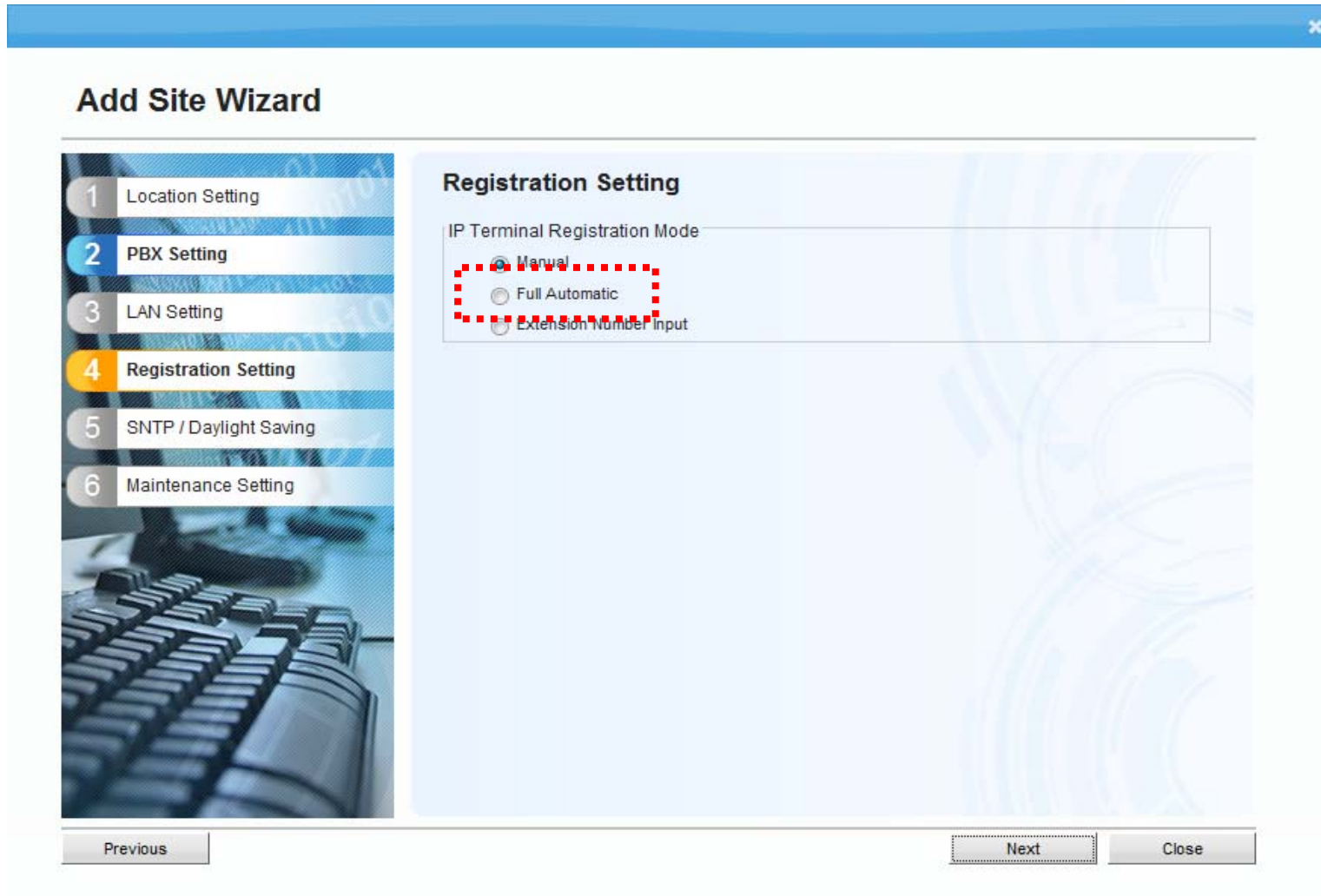

## Add Site Wizard

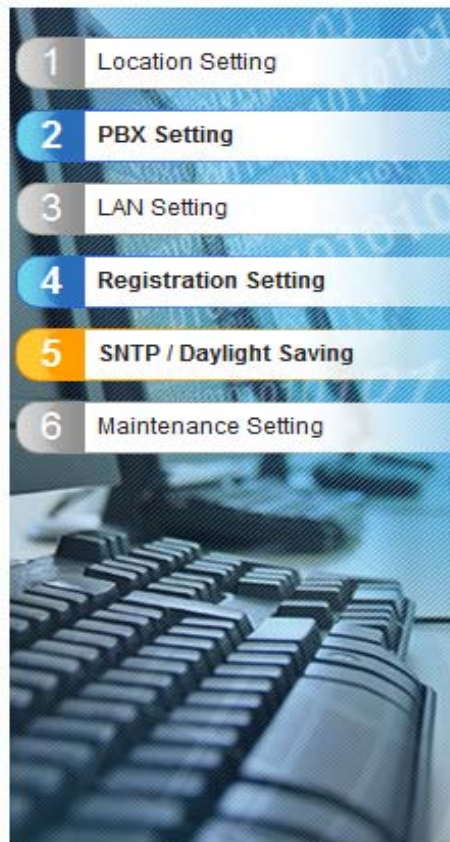

### SNTP / Daylight Saving

Automatic Time Adjustment:

- Disabled
- ISDN and Caller ID (FSK)
- SNTP

IP Address:

Port:

Daylight Saving:

- Enable
- Disable

Previous

Next

Close

# 1.5. Add Site Wizard

Master Unit

**Yes = ต้องการเป็น Back up Master**

**No = เป็น Slave ทั่วไป**

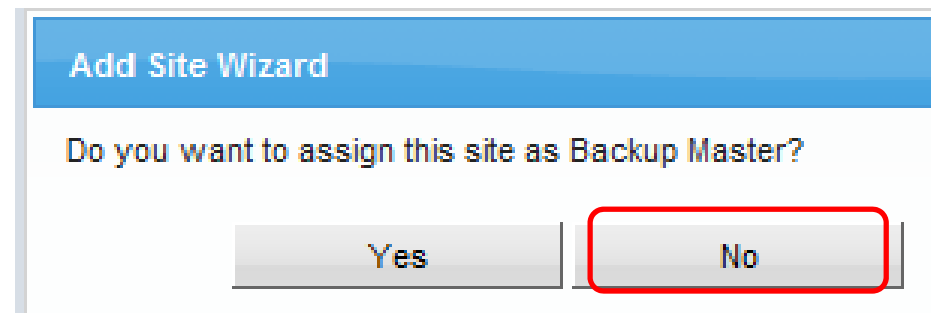

หากต้องการเป็น **Backup** สามารถเลือกได้ภายหลัง.

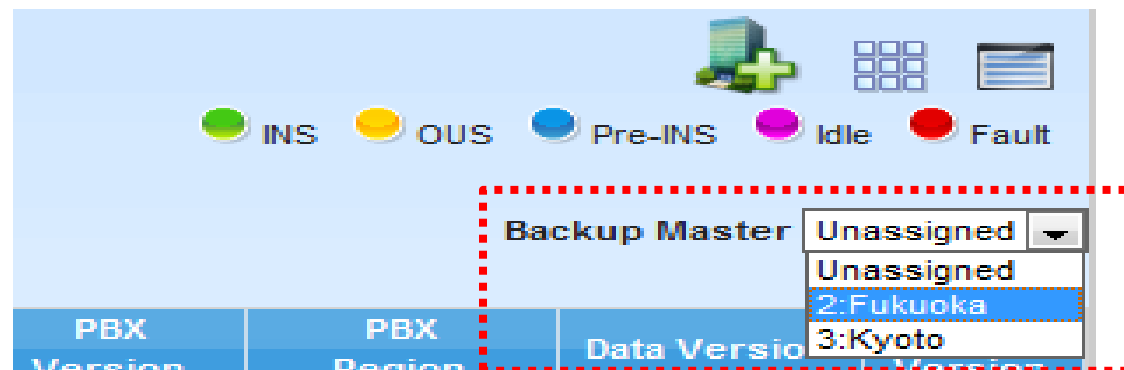

# 1.6. Change PBX Site Name

Master Unit

The screenshot shows the NS1000 Web Maintenance Console interface. At the top, it says "NS1000 Web Maintenance Console" and "Login as INSTALLER". The main area displays a hierarchical tree of sites. The top level has one site icon labeled "NS1000" which is highlighted with a red dashed box. Below it are three levels of sub-site icons. A yellow callout box points to the top-level icon with the text "Site ที่เพิ่มแล้ว รอ Register". In the top right corner, there is a menu icon (three horizontal lines) which is circled in red. A red dashed arrow points from this icon to another yellow callout box containing the text "เพื่อดู ข้อมูล / Version / Regist Slave".

Site ที่เพิ่มแล้ว รอ Register

เพื่อดู ข้อมูล / Version / Regist Slave

© Panasonic System Networks Co., Ltd. 2011-2012

# 1.7. Change PBX Site Name

Master Unit

สามารถเปลี่ยนชื่อ Site ต่างๆได้ .

The screenshot shows the NS1000 Web Maintenance Console interface. At the top, it says "NS1000 Web Maintenance Console" and "Login as INSTALLER". Below this is a navigation bar with icons for home, tools, and settings. A status bar shows "Backup Master: Unassigned" and a legend for site statuses: INS (green), OUS (yellow), Pre-INS (blue), Idle (purple), and Fault (red).

There are three tabs: "Registration", "De-registration", and "Forced De-registration". The "Registration" tab is active, showing a table of sites:

Site ID	Site Name	Location(MIB)	Status	PBX Mode	IP Address	MAC Address	PBX Version	PBX Region	Data Version	SRAM Version
1	NS1000		INS	master	10.64.213.194	00:80:F0:C6:0C:9A	002.10062	M	0002.0001	001
2	NS1000		Pre-INS	neutral	0.0.0.0	00:00:00:00:00:00		M	0002.0001	001

A red box highlights the "De-registration" tab and the "Site Name" column in the table. A red arrow points from this box to a dialog box below. The dialog box has a title bar with "Site ID" and "Site Name" columns:

Site ID	Site Name
1	HQ Tokyo
2	Brach Office A

Below the dialog box are "OK", "Cancel", and "Apply" buttons. The "Apply" button is circled in red. A yellow box with the text "Version" and Thai characters "ตัว" is positioned above the dialog box. A red dashed box highlights the "Data Version" and "SRAM Version" columns in the main table, with a red arrow pointing from the "Version" box to this area.

© Panasonic System Networks Co., Ltd. 2011

# 1.8 System Clear ឥឡូវ Slave

Slave  
Unit

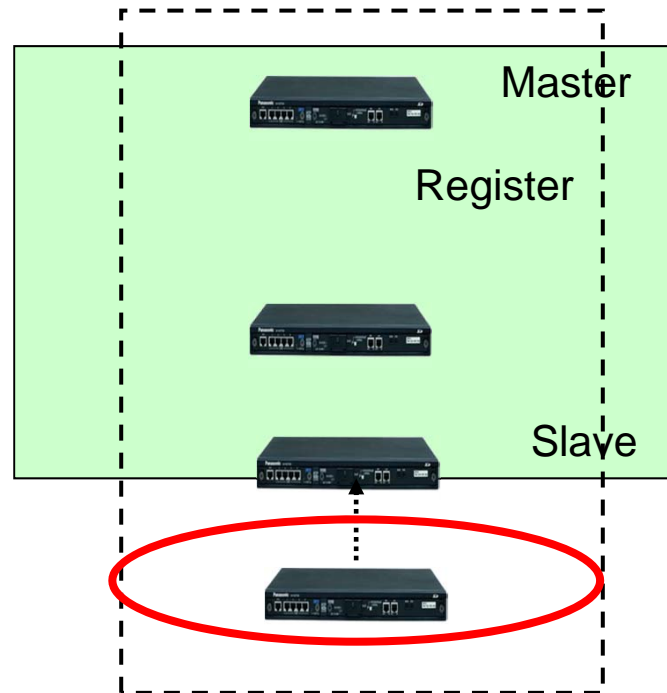

# 1.9. Easy Setup Wizard

Slave  
Unit

Connect PC with KX-NS1000 Slave unit.to start “Easy Setup Wizard”.

**1**

**เลือกเป็น Slave**

**ใส่ IP ที่ Master**

**2. Click “Next”.**

The screenshot displays the 'Easy Setup Wizard' window. On the left, a sidebar lists six steps: 1. Location Setting (highlighted), 2. PBX Setting, 3. LAN Setting, 4. Registration Setting, 5. SNTP / Daylight Saving, and 6. Maintenance Setting. The main area is titled 'Location Setting' and contains the following fields: 'PBX Type:' with radio buttons for 'Master' and 'Slave' (the 'Slave' button is selected and circled in red); 'If located on different network from Master PBX:' with a text input field for 'Master PBX IP' containing '192.168.0.101' (circled in red); 'Suffix Code:' with a dropdown menu showing 'G'; and 'Area:' with a dropdown menu showing 'Germany'. At the bottom, there are 'Previous', 'Next', and 'Close' buttons. The 'Next' button is circled in red. Annotations include a yellow box with the Thai text 'เลือกเป็น Slave' pointing to the 'Slave' radio button, another yellow box with 'ใส่ IP ที่ Master' pointing to the IP input field, and a blue box with '2. Click “Next”.' pointing to the 'Next' button.



# 1.10. Easy Setup Wizard

Slave Unit

2

**Easy Setup Wizard**

1 Location Setting  
2 **PBX Setting**  
3 LAN Setting  
4 Registration Setting  
5 SNTP / Daylight Saving  
6 Maintenance Setting

**PBX Setting**

Site name (1-32 characters): HS1000  
Time Zone: +0 :00  
Local Time: 2012/01/20 14:04:53

Previous Next Close

ใส่วันเวลาของ ตู้ Slave

3. Click "Next".

3

**Easy Setup Wizard**

1 Location Setting  
2 PBX Setting  
3 **LAN Setting**  
4 Registration Setting  
5 SNTP / Daylight Saving  
6 Maintenance Setting

**LAN Setting**

Obtain an IP address automatically  
 Use the following IP address

IP Address: 192.168.0.201  
Subnet Mask: 255.255.0.0  
Default Gateway: 0.0.0.0

Obtain DNS server address automatically  
 Use the following DNS server address

Preferred DNS IP Address: 0.0.0.0  
Alternative DNS IP Address: 0.0.0.0

Obtain DSP IP address automatically  
 Use the following DSP IP address

DSP Card #1  
IP Address 1: 192.168.0.202  
IP Address 2: 192.168.0.203

DSP Card #2  
IP Address 1: 192.168.0.204  
IP Address 2: 192.168.0.205

Previous Next Close

ใส่ IP ของ ตู้ Slave . / DSP

2. Click "Next".

# 1.11. Easy Setup Wizard

Slave  
Unit

4

## Easy Setup Wizard

1 Location Setting

2 PBX Setting

3 LAN Setting

4 Registration Setting

5 SNTP / Daylight Saving

6 Maintenance Setting

### Registration Setting

IP Terminal Registration Mode

- Manual
- Full Automatic
- Extension Number Input

One-look Network (Trial Activation Key):

\*available for 60 days from current local time.

- Active
- Non Active

**Active = ใช้แบบ 60 วัน**

**Non Active = ใช้ AK ที่ Regist**

Previous

Finish Close

กด Finish

### LAN Setting

LAN setting is changed.

It is necessary to reboot system to reflect the setting.  
If you are ready, press OK button.

OK

กด OK

# 1.12. Easy Setup Wizard

Master  
Unit

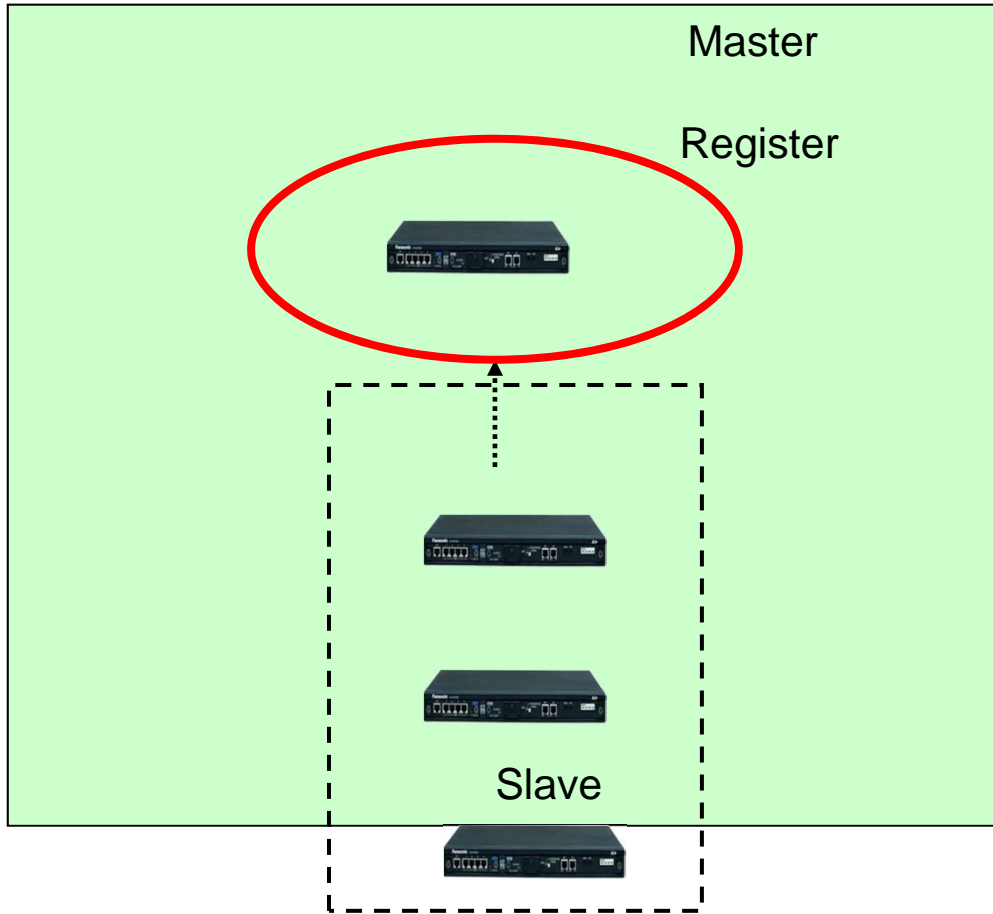

# 1.13 Register Slave unit

Master Unit

NS1000 | Web Maintenance Console

Login as INSTALLER

INS OUS Pre-INS Idle Fault

Registration De-registration Forced De-registration

Unit ID	Site Name	Location(MIB)	Status	PBX Mode	IP Address	MAC Address	PBX Version	PBX Region
1	HQ Tokyo		INS	master	192.168.0.101	00:80:F0:CA:DB:BC	001.01007	G
2	Fuku Branch Office A		Pre-INS	neutral	0.0.0.0	00:00:00:00:00:00		G

OK Cancel Apply

© Panasonic System Networks Co., Ltd. 2011

# 1.14. Register Slave unit

Master Unit

The image displays two sequential screenshots of a software registration interface. Both screenshots are titled "Registration" and feature two main columns: "Available Site" and "Selected Site for Registration".

**Left Screenshot:** The "Available Site" list contains one item, "2 Branch Office A", which is highlighted with a blue selection bar and enclosed in a red rectangular box. Below the list, there are two buttons: the top one is labeled "==" and the bottom one is labeled "<==". The "Selected Site for Registration" column is currently empty. At the bottom right, there are "Next" and "Cancel" buttons.

**Right Screenshot:** The "Available Site" list is empty. The "Selected Site for Registration" list now contains the item "2 Branch Office A", highlighted with a blue selection bar and enclosed in a red rectangular box. Below the list, there are two buttons: the top one is labeled "==" and the bottom one is labeled "<==". The "Next" and "Cancel" buttons at the bottom right are also enclosed in a red rectangular box.

# 1.15. Register Slave unit

Master  
Unit

Registration

## Registration Executing

No.	ID	Name	Status
1	2	Branch Office A	Registering...

Cancel

Registration

## Registration Completed

No.	ID	Name	Status
1	2	Branch Office A	

Close

After registration is completed, the slave unit will reboot automatically.

รอประมาณ 3 นาที

Login as INSTALLER



System Capacity Selection : Standard Type

Backup Master Unassigned

Registration

De-registration

Forced De-registration

แสดง INS

	Site ID	Site Name	Location(MB)	Status	PBX Mode	PBX Model	IP Address	MAC Address	PBX Version	PBX Region	Data Version
	1	NS1000 Master		INS	master	KX-NS1000	192.168.0.70	00:80:F0:F9:30:B0	004.30025	BX	0004.0003
	2	NS100060		INS	slave	KX-NS1000	192.168.0.60	00:80:F0:C6:0C:FA	004.30025	BX	0004.0003

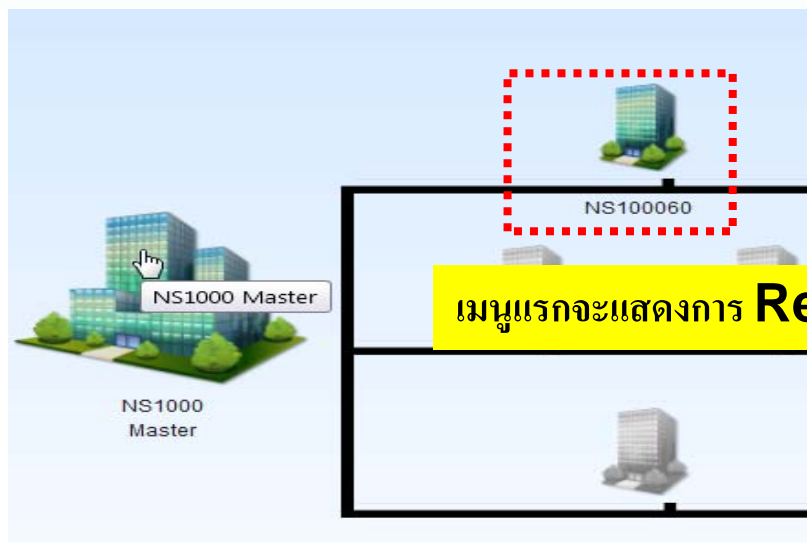

เมนูแรกจะแสดงการ **Regist** เรียบร้อยแล้ว

# 1.16. Register Slave unit

Master Unit

After 3 minutes, slave unit becomes In Service.

## Home Screen

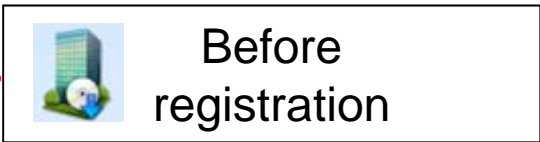
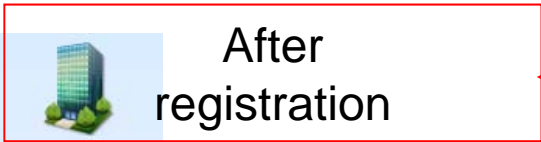
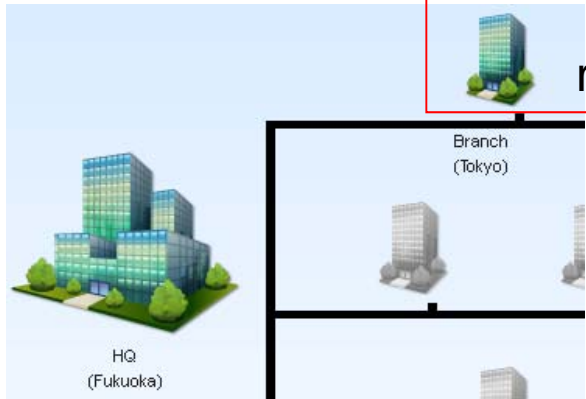

## List View Screen

NS1000 Web Maintenance Console

Login as INSTALLER

INS OUS Pre-INS Idle Fault

Registration De-registration Forced De-registration

Site ID	Site Name	Location(MIB)	Status	PBX Mode	IP Address	MAC Address	PBX Version	PBX Region
1	HQ Tokyo		INS	master	10.64.213.194	00:80:F0:C6:0C:9A	001.02003	M
2	Brach Office A		INS	slave	10.178.19.199	00:80:F0:C6:09:28	001.02003	M



# 1. KX-UT670 : Factory Default

## Settings

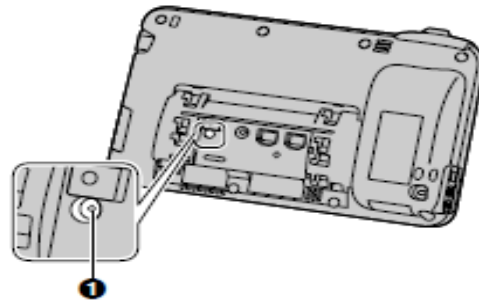

When you reset the unit, all settings are returned their factory default status and all data is erased. You can reset the unit in the following 2 ways.

- **Clear data and settings**  
All unit settings and the settings and registered data of applications are erased. However, applications are not erased.
  - **Reset to factory default**  
All data is erased. Applications, apart from pre-installed applications, are also erased.
1. After starting the unit, press and hold the RESET button (❶) with a pointy object for more than 5 seconds until the screen is cleared.

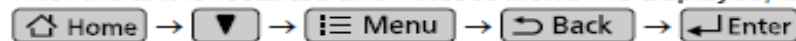

2. After the unit is restarted and **\*\*Reset Menu\*\*** is displayed, tap the key sheet in the following order:



3. Tap  or  to select the resetting type, and then tap .

### Note

- For details about the key sheet, refer to the Operating Instructions on the Panasonic Web site (→ see **Introduction**).
- Data stored on the SD card is not erased.
- If you tap **[Cancel]**, the unit will start-up and the Home screen is displayed.
- When the reset is complete, the unit will automatically restart.

## 2.1 HDV : Factory Default

1. **ต่อ Power เข้าเครื่อง**
2. **กด เลข 1 5 9 \* พร้อมกัน รอจนขึ้น Factory Reset / รอจนขึ้น Factory Done**
3. **ให้ ดึง Power ออก และ ต่อใหม่อีกครั้ง**

### การเช็ค IP เครื่อง

1. **Menu / System Setting --> Enter**
2. **Status --> Enter**
3. **เลือก จดพบ IPV4 Setting --> Enter**
4. **เลือก IP address / Subnet Mask --> Enter**

## 2.2 HDV : การโปรแกรม

### กำหนด Mode IP เครื่อง

1. **Menu / System Setting --> Enter**
2. **Network Setting --> Enter**
3. **เลือก จดพบ IPV4 Setting --> Enter**
4. **เลือก DHCP / Static --> Enter**
5. **หากเลือก Static ให้ป้อน IP Address ที่ต้องการ --> Enter**
6. **กด Next เพื่อออกแบบ Subnet mask / Gateway ที่ต้องการ**

## 2.3 HDV : การโปรแกรม

การเปิดให้ สามารถ โปรแกรม ผ่าน web ได้

1. **Menu / Basic Setting --> Enter**
2. **เลื่อน ลูกศร จน พบ Other Option --> Enter**
3. **เลือก Embedded web --> Enter**
4. **เลือก ON --> Enter**

จากนั้นเข้าไปโปรแกรม ผ่าน Web ตาม IP address ที่กำหนดไว้ เหมือน  
เครื่อง UTXX

USER : admin / Password : adminpass

**ขอบคุณครับ.**