

โปรเฟสชั่นแนล พี. เอ. บี. เอ็กซ์.

30/270 ซอยนวมินทร์ 80 แขวงนวลจันทร์ เขตบึงกุ่ม กรุงเทพฯ 10230

Hotline : 084-920-5065 Tel : 02-519-1718 , 02-107-3057

E.Mail : info@pfpbx.com , jirasak_service@hotmail.com

www.pfpbx.com

ELECTRONIC MODULAR SWITCHING SYSTEM KX-T123210DB/KX-T123210D

Installation and Operation Manual for Added and Changed Features

Please read this Manual first and then another Installation Manual for programming.

This manual is available for KX-T123210DB/KX-T123210D which have the mark (2) on the plate as shown below.



Note:

1. Use the "STORE" key instead of "MEMORY" key, for KX-T7020, 7030, 7050 and 7130 do not have the "MEMORY" key.
2. Use the "AUTO ANSWER" key instead of "AUTO ANS" key, for KX-T7020, 7030, 7050 and 7130 do not have the "AUTO ANS" key.
3. For the Features of Flexible keys, refer to this manual.
4. Extension of jack number 01 should be connected to KX-T7030, 7130, 30830, 61630, 123230, 123230D and 123235, for programming system data.
5. All the programming procedures described in the Installation Manual have been modified. Delete the step 2 "Press the NEXT button" from every feature of the programming in another Installation Manual. For the further detail, see page 4 of this manual. This manual describes the revised procedures from which the step 2 has already been deleted.

System Component

	Model No.	Description
Service unit	KX-T123210DB/ KX-T123210D	Electronic Modular Switching System
Telephone	KX-T7020 KX-T7030 KX-T7050 KX-T7130 KX-T123220 KX-T123230 KX-T123230D KX-T123235 KX-T123250	EMSS Proprietary Telephone (12 CO's) EMSS Proprietary Telephone with LCD (12 CO's) EMSS Proprietary Telephone (12 CO's) EMSS Proprietary Telephone with LCD (12 CO's) EMSS Proprietary Telephone (12 CO's) EMSS Proprietary Telephone with LCD (12 CO's) EMSS Proprietary Telephone with LCD (12 CO's) EMSS Proprietary Telephone with LCD (12 CO's) EMSS Proprietary Telephone (12 CO's)
	KX-T61620 KX-T61630 KX-T61650 KX-T30820 KX-T30830 KX-T30850	EMSS Proprietary Telephone (6 CO's) EMSS Proprietary Telephone with LCD (6 CO's) EMSS Proprietary Telephone (6 CO's) EMSS Proprietary Telephone (3 CO's) EMSS Proprietary Telephone with LCD (3 CO's, 8 DSS's) EMSS Proprietary Telephone (3 CO's)
Optional equipment	KX-T7040 KX-T123240 KX-T61640	DSS Console (32 DSS's, 16 Feature buttons) DSS Console (32 DSS's, 16 Feature buttons) DSS Console (16 DSS's 16 Feature buttons)
	KX-T123241 KX-T123270 KX-T123271 KX-T123280 KX-T123281 KX-T123285 KX-T123286B KX-T123291 KX-T123292 KX-T123295 KX-T123296	DSS Console Card Expansion Card (up to eight extension lines) Expansion Card (up to four extension lines) Expansion Card (up to four CO lines) Expansion Card (up to two CO lines) Off Premise Extension Card Off Premise Extension Unit Direct Inward System Access Card Direct Inward System Access Outgoing Message Card Diagnostic Card MODEM Card
	KX-T30860 KX-T30865 KX-T30890 KX-A202 KX-A203 KX-A204 KX-A205 KX-A26	Doorphone Adaptor Doorphone Headset Cord for CO lines Clip Terminal for CO lines Cable for extension lines Clip Terminal for extension lines Battery Adaptor

TABLE OF CONTENTS

Example of Programming	4
Added Features	
<Connection>	
The Parallel Connection of the Proprietary Telephone and the Standard Telephone	7
<Program>	
Standard Telephone Connection with Proprietary Telephone	8
<Detailed Features>	
Flexible MESSAGE (Message Waiting) Button	9
F1-SAVE Selection	10
Message Waiting	10
Message Waiting for a Standard Single Line Telephone	11
Last Number Redial/Call Transfer — To Extension/Off Hook Call Announcement (OHCA)	11
Changed Features	
<Program>	
Busy Tone	12
Toll Restriction	13
Toll Restriction of System Speed Dialing — Boundary Class Assignment	14
Toll Restriction — Denied Code Assignment	15
Toll Restriction — Exceptional Code Assignment	16
Hold Recall Time Set	17
Transfer Recall Time	18
System Data Dump	19
Service Class Assignment of Toll Restriction	22
<Detailed Feature>	
F3-FWD/DND Button Selection	23
Cancelled Features	
24	
Programming Table	25

the
is the
e
ode.
e END

Example of Programming

All the programming procedures described in the Installation Manual have been modified. Delete the step 2; "Press the NEXT button" from every feature of the programming in another Installation Manual. See the example below — the portion that should be deleted is shown shaded.

This manual describes the revised procedures from which the step 2 has already been deleted, as "Revision" below.

Original	Revision
<div style="border: 1px solid black; padding: 5px; margin-bottom: 10px; text-align: center;"> AB = [0] [0]: speed access code 00 ⋮ [9] [9]: speed access code 99 </div> <div style="border: 1px solid black; padding: 5px; margin-bottom: 10px; text-align: center;"> CD = [8] [1]: access number of Trunk Group 1 ⋮ [8] [8]: access number of Trunk Group 8 </div> <p style="text-align: center;">[01][NEXT][AB][CD][phone number][MEMORY][END]</p> <p style="text-align: center;"> ↑ SELECT </p>	<div style="border: 1px solid black; padding: 5px; margin-bottom: 10px; text-align: center;"> AB = [0] [0]: speed access code 00 ⋮ [9] [9]: speed access code 99 </div> <div style="border: 1px solid black; padding: 5px; margin-bottom: 10px; text-align: center;"> CD = [8] [1]: access number of Trunk Group 1 ⋮ [8] [8]: access number of Trunk Group 8 </div> <p style="text-align: center;">[01][AB][CD][phone number][MEMORY][END]</p> <p style="text-align: center;"> ↑ SELECT </p>
<ol style="list-style-type: none"> 1. Dial (01) or press the AUTO button. "Speed Dialing" will be displayed. 2. Press the NEXT button. "Speed NO? → " will be displayed. 3. Dial (00 through 99) or press the NEXT button, for speed access code entry. 4. Enter automatic line access number or trunk group number. 5. Enter the phone number. 6. Press the MEMORY button. The memory indicator will be lit. 7. <ul style="list-style-type: none"> ● To advance to the next speed access code, press the NEXT button. ● To return to the previous speed access code, press the PREV button. ● To go to the desired speed access code, press the SELECT button and then dial the speed access code. 8. Repeat steps 4 to 7, to program the other phone numbers. 9. To return to the initial programming mode, press the END button. 	<ol style="list-style-type: none"> 1. Dial (01) or press the AUTO button. "Speed NO? → " will be displayed. 2. Dial (00 through 99) or press the NEXT button, for speed access code entry. 3. Enter automatic line access number or trunk group number. 4. Enter the phone number. 5. Press the MEMORY button. The memory indicator will be lit. 6. <ul style="list-style-type: none"> ● To advance to the next speed access code, press the NEXT button. ● To return to the previous speed access code, press the PREV button. ● To go to the desired speed access code, press the SELECT button and then dial the speed access code. 7. Repeat steps 3 to 6, to program the other phone numbers. 8. To return to the initial programming mode, press the END button.

When the System Program Switch on the KX-T123210 is set to the PROGRAM position, the function of the KX-T7030 and the KX-T7130 connected to jack number 01 will change as follows.

KX-T7030

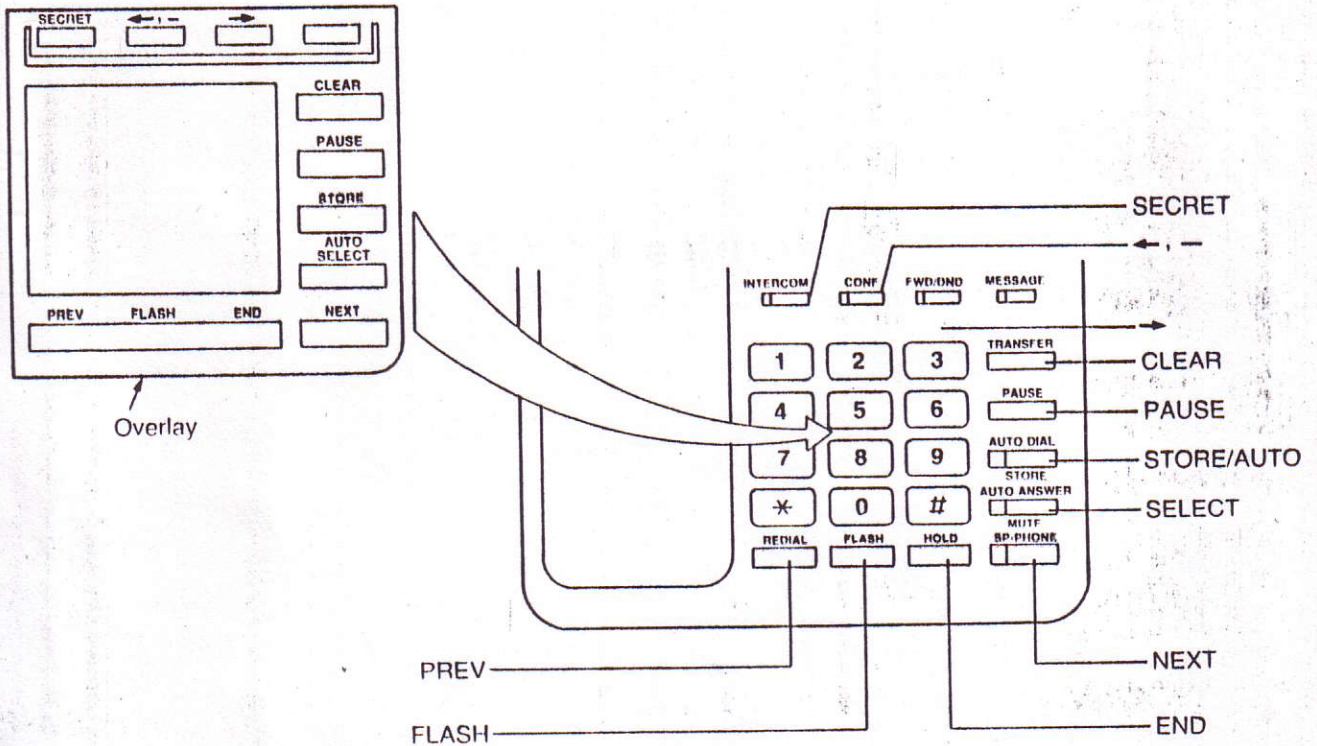

KX-T7130

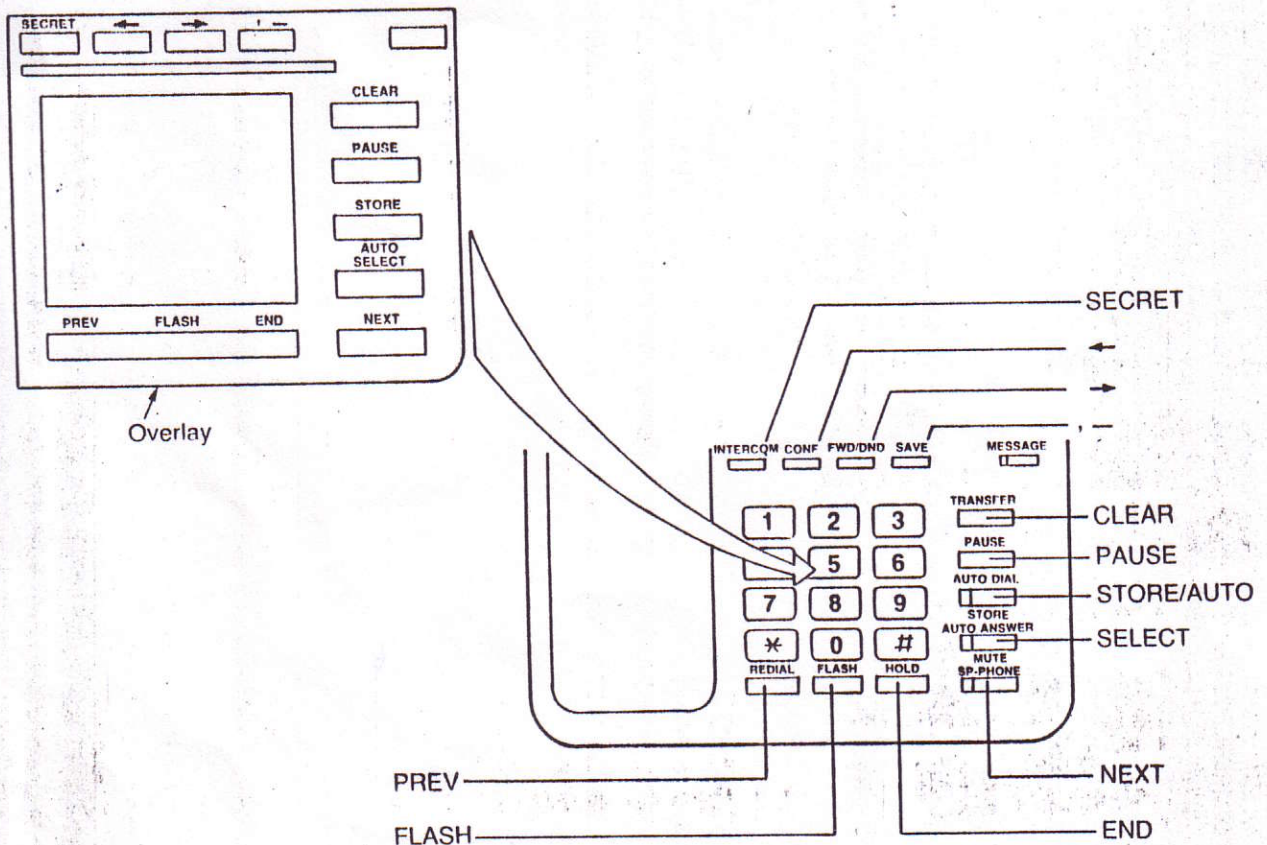

Added Features

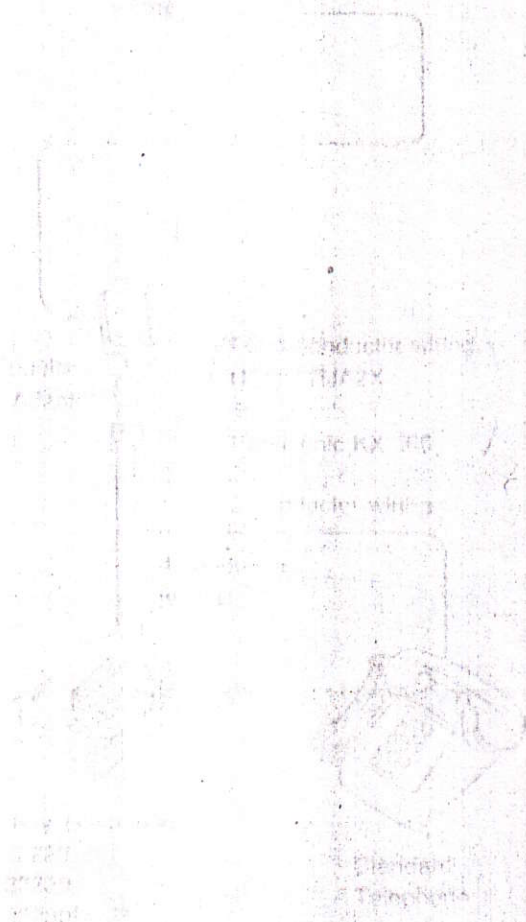

The Parallel Connection of the Proprietary Telephone and the Standard Telephone

- Any extension can be connected in parallel with the proprietary telephone and the standard telephone.
- In the event of a power failure, CO1, CO2, CO5, CO6, CO9 and CO10 can be accessed using the standard telephones that are connected in parallel with proprietary telephones to extensions of jack number 01, 02, 09, 10, 17 and 18 respectively.
- If the extension receives a call, a ringing will be heard from the proprietary telephone and the standard telephone. You can answer the call by using either the proprietary telephone or the standard telephone.
- An answering machine, a facsimile, a MODEM (personal computer) etc. can be connected instead of the standard telephone.
- You can program that the standard telephone will not work. For programming, refer to the "Standard Telephone Connection with Proprietary Telephone" on page 8 in this manual.

Note:

- The LCD on the proprietary telephone will show you the standard telephone is used.
- The following features will not work by the standard telephone connected in parallel with the proprietary telephone.
 - Call splitting
 - External feature access
 - Account code input
 - Conference
 - Pickup dialing
- The standard telephone connected in parallel with the proprietary telephone can not make a call in the following cases;
 - The proprietary telephone is set to BGM mode.
 - The proprietary telephone is receiving the paging through the built-in-speaker.
 - The proprietary telephone is set to PROGRAMMING mode.
- The standard telephone connected in parallel with the proprietary telephone will not ring in the following cases;
 - The proprietary telephone is set to Automatic Answer-Intercom.
 - The proprietary telephone is set to Voice alerting mode.

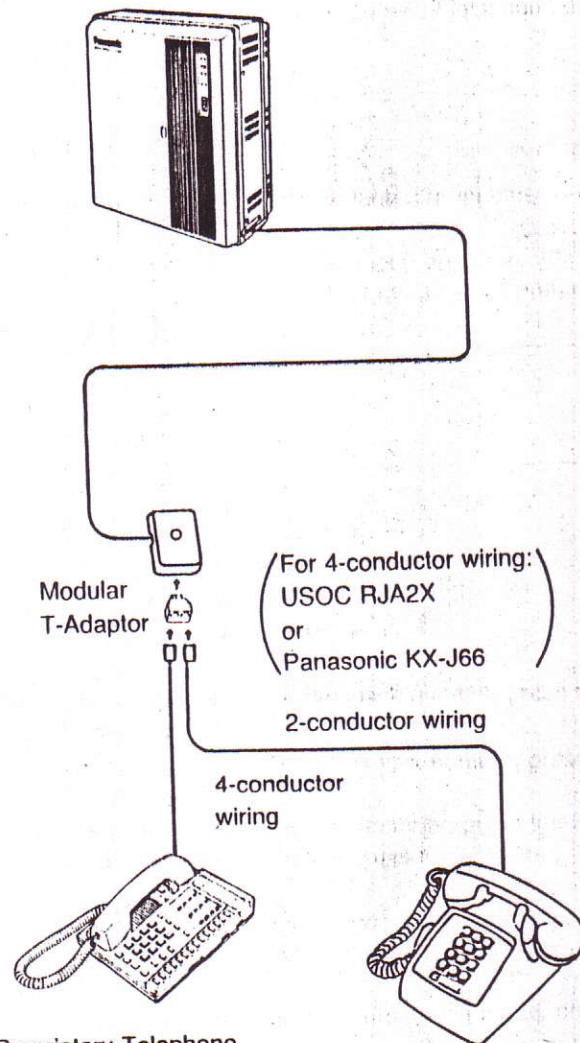

Proprietary Telephone
 KX-T123220
 KX-T123230
 KX-T123230D... ✱
 KX-T128235 ✱
 KX-T123250
 KX-T61620
 KX-T61630
 KX-T61650
 KX-T7020
 KX-T7030
 KX-T7050
 KX-T7130 ✱
 KX-T30830
 KX-T30820
 KX-T30850

- The models above which have a mark ✱ require the 6-conductor wiring.

Standard Telephone Connection with Proprietary Telephone

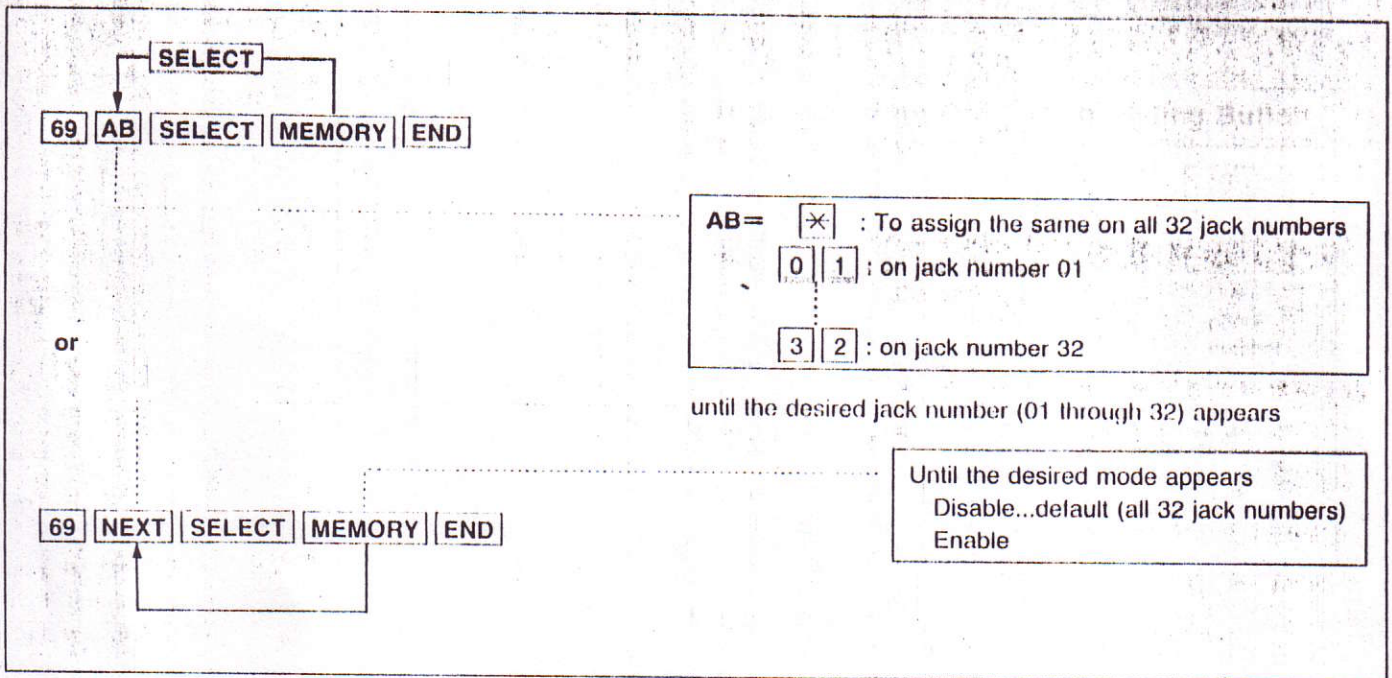

Description

Through programming, you can select whether the standard telephone which is connected in parallel with the proprietary telephone works or not.

Enable The standard telephone works.

Disable The standard telephone does not work.

Programming

1. Dial (69).
"Jack NO? → " will be displayed.
2. Press the NEXT button or dial the jack number (01 through 32 or x).
"#01: Disable" will be displayed and
"Disable" will blink.
3. Press the SELECT button to alternate between
"Disable" and "Enable" to select the desired mode.

4. Press the MEMORY button.
The LCD will stop blinking.
5.
 - To advance to the next jack number, press the NEXT button.
 - To return to the previous jack number, press the PREV button.
 - To go to a desired jack number, press the SELECT button and then dial the jack number.
6. Repeat steps 3 to 5, to program the ringing mode on the other jack numbers.
7. To return to the initial programming mode, press the END button.

Conditions

When a call reaches to KX-T30830, 61630, 123230 or 123235, two types of ring tones sound. This is normal and we recommend you to select "Disable" by programming if you do not use the standard telephone.

Programming Table

See page 50.

Flexible MESSAGE (Message Waiting) Button

To Change into DSS Button



Press
MESSAGE



Dial "1"

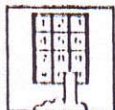

Dial the
extension
number
which is
set newly
(100 through 199)

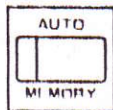

Press
MEMORY

Description

Allows the MESSAGE button to change into the DSS (Direct Station Selection) button.

The proprietary telephone is available.

Operation

- Be sure the handset is in the cradle and the SP-PHONE button is off.
- Set the MEMORY switch of the proprietary telephone to "PROGRAM".

1. Press the MESSAGE button.
2. Dial (1).
3. Dial the extension number which is set newly (100 through 199).
4. Press the MEMORY button.

To return to the MESSAGE button:

1. Press the MESSAGE button.
2. Dial (3).
3. Press the MEMORY button.

- After programming the MESSAGE button, return the MEMORY switch to the "SET" position.

To Change into One Touch Dialing Button



Press
MESSAGE



Dial "2"



Dial "9"

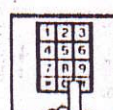

Dial
phone
number

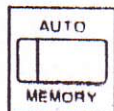

Press
MEMORY

Description

Allows the MESSAGE button to be used as a one touch dialing button.

Up to 16 digits can be stored into the MESSAGE button.

Operation

- Be sure the handset is in the cradle and the SP-PHONE button is off.
- Set the MEMORY switch of the proprietary telephone to "PROGRAM".

1. Press the MESSAGE button.
2. Dial (2).
3. Dial (9).

- You may dial 81 through 88 instead of 9.
9... An extension can automatically select an Idle line within the CO line enable to call.
81 through 88... An extension can select a trunk group designated.

4. Dial the phone number.
5. Press the MEMORY button.

To return to the MESSAGE button:

1. Press the MESSAGE button.
2. Dial (3).
3. Press the MEMORY button.

- After programming the MESSAGE button, return the MEMORY switch to the "SET" position.

F1/SAVE Selection



Dial "71"

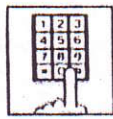

Dial "1"
or "2"

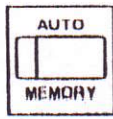

Press
MEMORY

["1": for Programmable feature]
["2": for SAVE

Description

The SAVE button is not provided with KX-T30850, KX-T61650, KX-T123250, KX-T7020, KX-T7030 and KX-T7050.

The F1 button can be changed from programmable feature button to the SAVE button.

dial1 mode programmable feature function
dial2 mode SAVE function

Operation

- Be sure the handset is in the cradle and the SP-PHONE button is off.
 - Set the MEMORY switch of the proprietary telephone to "PROGRAM".
1. Dial (7) (1).
 2. Dial (1) for the programmable feature button or dial (2) for the SAVE button.
 3. Press the MEMORY button.
- After programming the F1 button, return the MEMORY switch to the "SET" position.

Message Waiting

(See page 4-37 in another installation manual)

To cancel the message at the extension where the message is left.



Lift handset
or press
SP-PHONE

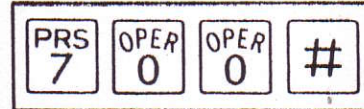

Dial "700 #"



Hang up or
press
SP-PHONE

Description

The operation of Message Waiting is partially changed. Please correct it on page 4-37 in another installation manual.

Operation

To cancel the message at the extension where the message is left.

1. Lift the handset or press the SP-PHONE button.
2. Dial (700 #)
The MESSAGE indicator will go out.
All message will be canceled.
3. Hang up or press the SP-PHONE button.

Message Waiting for a Standard Single Line Telephone

Setting



Lift handset

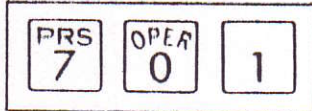

Dial "701"

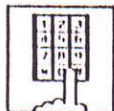

Dial extension number

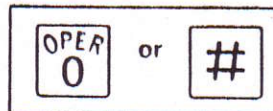

Dial "0" or "#"



Hang up

Canceling a message



Lift handset



Dial "702"



Dial extension number

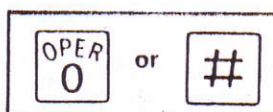

Dial "0" or "#"



Hang up

Description

When the dialed intercom extension is busy or does not answer, a single line telephone can also inform the extension of a receiving sign. Only a telephone which has a MESSAGE button can receive the message.

Operation

Setting

1. Lift the handset.
2. Dial (701).
3. Dial the extension number (100 through 199).
4. Dial (0) or (#).
5. Hang up.

Canceling a message

1. Lift the handset.
2. Dial (702).
3. Dial the extension number (100 through 199).
4. Dial (0) or (#).
5. Hang up.

Last Number Redial

(See page 4-8 in another Installation Manual)

The KX-T7020, 7030, 7050 and 7130 can be used for Automatic Redialing of this feature.

Call Transfer To Extension

(See page 4-18 in another Installation Manual)

Pressing the TRANSFER button is also available to change the party to whom a call is transferred before hanging up.

Press the TRANSFER button to retrieve the call, then repeat the procedure of Call Transfer.

Conditions

If the called party is busy or does not answer, you may return to the calling party also by pressing the TRANSFER button.

Transfer Recall Time is changed from "30 seconds or 15 seconds" to "30 seconds or 2 minutes".

Off Hook Call Announcement (OHCA)

(See page 4-23 in another Installation Manual)

The KX-T7130 can be used for this feature.

Changed Features

- Busy tone is revised as follows (see page 6-7 in another Installation Manual):

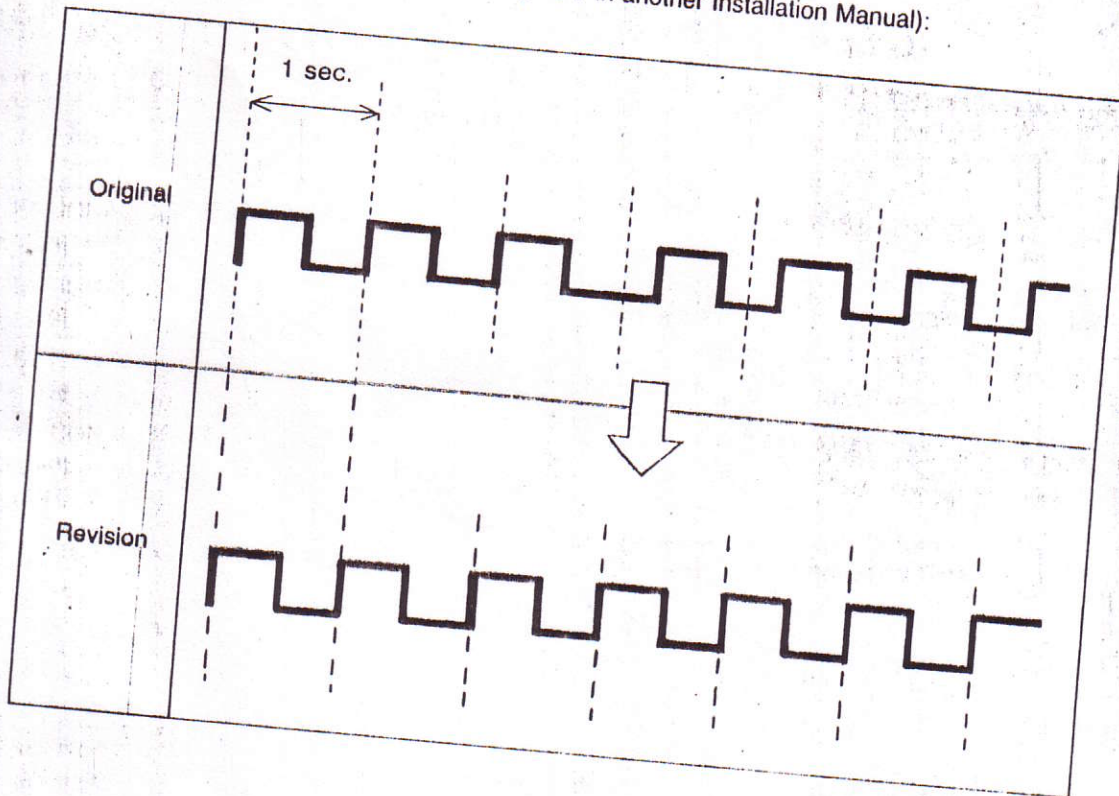

Toll Restriction

The selective use of this feature permits restricted dialing to specific stations. A Class of Service can be assigned to a particular station which prohibits or limits that station's dialing ability. The following are the available five Classes of Service.

TOLL RESTRICTION — DENIED CODE TABLE

	SERVICE CLASS				
	1	2	3	4	5
CLASS-2 DENIED CODE (20 locations)	A	D	D	D	D
CLASS-3 DENIED CODE (20 locations)	A	A	D	D	D
CLASS-4 DENIED CODE (20 locations)	A	A	A	D	D
CLASS-5 DENIED CODE (20 locations)	A	A	A	A	D

TABLE-1

TOLL RESTRICTION — EXCEPTIONAL CODE TABLE

	SERVICE CLASS				
	1	2	3	4	5
EXCEPTIONAL CODE [01]~[05]	-	E	E	E	E
EXCEPTIONAL CODE [06]~[10]	-	E	E	E	-
EXCEPTIONAL CODE [11]~[15]	-	E	E	-	-
EXCEPTIONAL CODE [16]~[20]	-	E	-	-	-

TABLE-2

A: CALL IS ALLOWED
D: DENIED OTHER THAN EXCEPTIONAL CODE

-: IGNORED
E: ENABLE

※ECOS=Extension Class Of Service
SDBC=Speed Dial Boundary Class

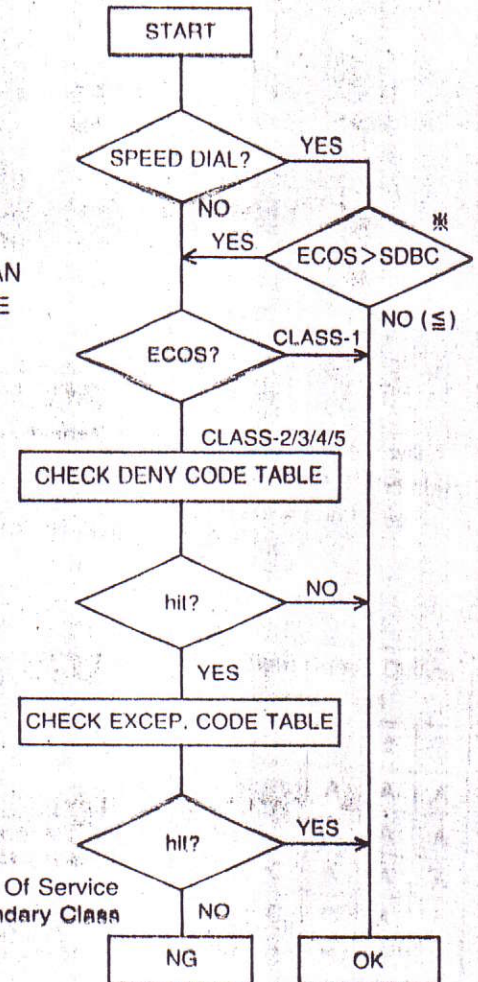

1. Service class 1 will allow all calls.
2. Service class 2 will deny 20 codes programmed as a denied code and allow 20 codes programmed as an exceptional code (location 01~20).
3. Service class 3 will deny 40 codes programmed as CLASS-2 and CLASS-3 denied code and allow 15 codes programmed as an exceptional code (location 01~15).
4. Service class 4 will deny 60 codes programmed as CLASS-2, CLASS-3 and CLASS-4 denied code and allow 10 codes programmed as an exceptional code (location 01~10).
5. Service class 5 will deny 80 codes programmed as CLASS-2, CLASS-3, CLASS-4 and CLASS-5 denied code and allow 5 codes programmed as an exceptional code (location 01~05).

The following should be set.

- "Toll Restriction of System Speed Dialing — Boundary Class Assignment" on page 14.
- "Toll Restriction — Denied Code Assignment" on page 15.
- "Toll Restriction — Exceptional Code Assignment" on page 16.
- "Service Class Assignment of Toll Restriction" on page 22.

Toll Restriction of System Speed Dialing—Boundary Class Assignment

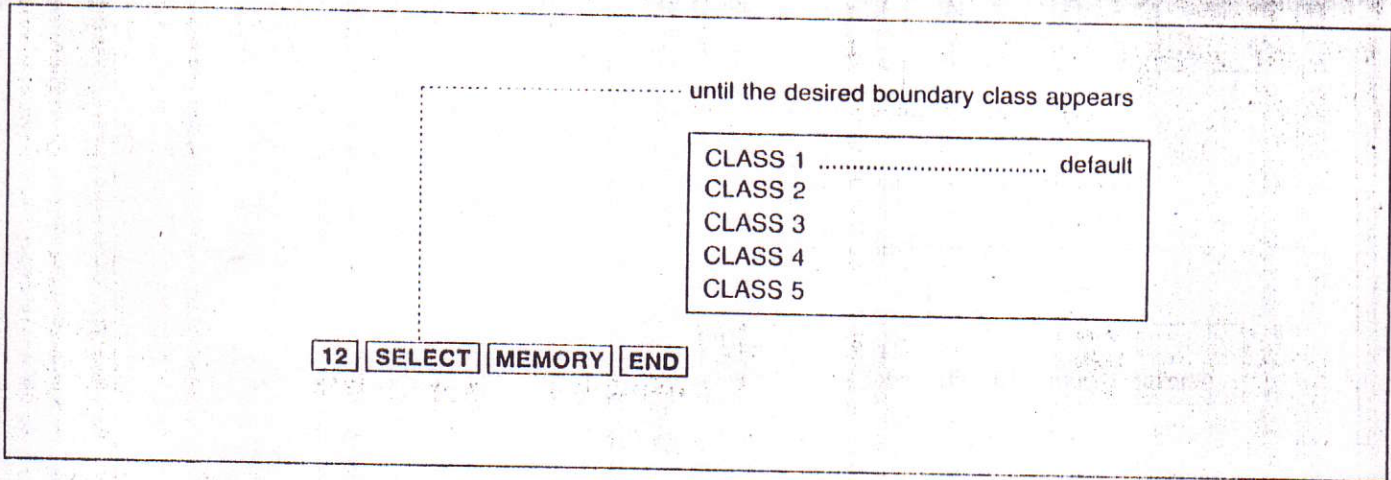

Description

You can select the boundary class which is free from the speed dialing toll restriction.

Programming

1. Dial (12).
"Boundary Class-1" will be displayed and "1" will blink.
2. Repeat pressing the SELECT button until the desired class number appears, or dial the class number (1 through 5).
3. Press the MEMORY button.
The LCD will stop blinking.
4. To return to the initial programming mode, press the END button.

Conditions

If you set the boundary to CLASS 2, the system will allow system speed dialing on service class 1 and class 2, but restrict on service class 3, class 4 and class 5 according to the toll restriction checking.
Refer to page 13.

		System Speed Dialing Boundary Class				
		1	2	3	4	5
Service Class	1	A	A	A	A	A
	2	C	A	A	A	A
	3	C	C	A	A	A
	4	C	C	C	A	A
	5	C	C	C	C	A

A: allowed
C: checked

Programming Table

See page 27.

Toll Restriction—Denied Code Assignment

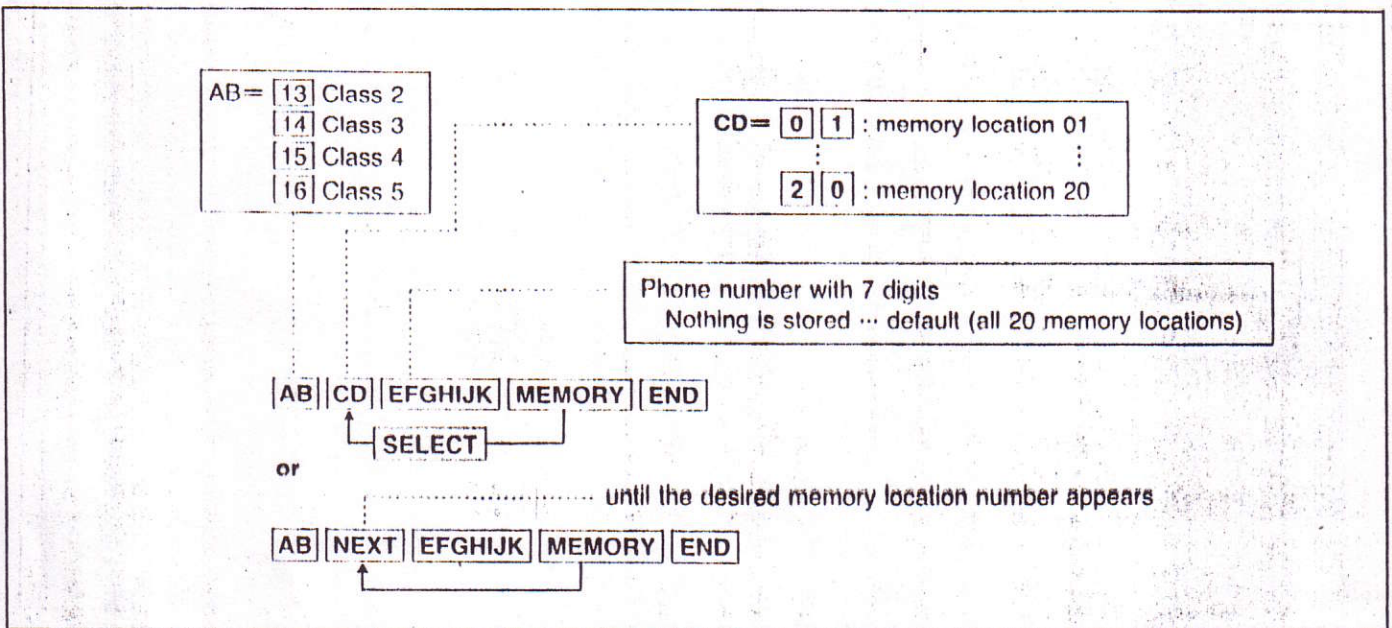

Description

For Service Class 2, 3, 4 or 5 (see "Toll Restriction") up to 20 phone numbers can be selected for use in toll dialing.

Phone numbers programmed will be denied. All extensions programmed for Service Class Selections shall be assigned to the same denied code assignment plan.

Programming

1. ● Dial (13) for class 2.
● Dial (14) for class 3.
● Dial (15) for class 4.
● Dial (16) for class 5.
"Code NO? → " will be displayed.
2. Dial (01 through 20) or press the NEXT button.
Example:
When dial (01) or press the NEXT button.
● The LCD will show "01:" when nothing is stored in memory location number "01".
When the phone number 212 * * * * * has been stored, "01: 212 * * * * *" will be displayed.

3. Dial the 7-digit phone number.
● To erase a wrong entry, press the CLEAR button.
4. Press the MEMORY button.
● The MEMORY indicator will be lit.
5. ● To advance to the next memory location number, press the NEXT button.
● To return to the previous memory location number, press the PREV button.
● To go to a desired memory location number, press the SELECT button and dial the memory location number.
6. Repeat steps 3 to 5.
7. To program denied code to another class, go to step 1.
8. To return to the initial programming mode, press the END button.

Conditions

- Each phone number should consist of 7 digits.
- * substitutes for a number.

Programming Table

See pages 27 and 28.

Toll Restriction—Exceptional Code Assignment

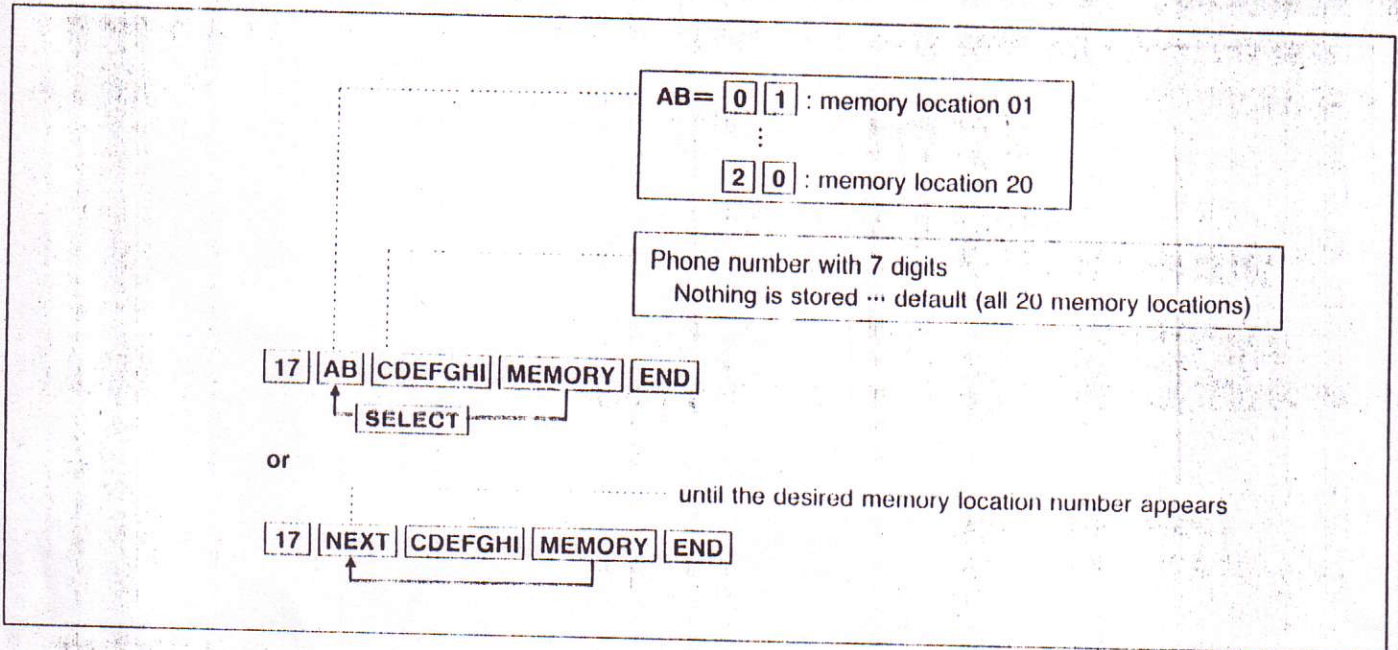

Description

Through programming, the desired extensions will be allowed to dial the phone numbers which are restricted by "Denied Code Assignment". For Service Class 2, 3, 4 or 5 up to 20 phone numbers can be selected.

Programming

1. Dial (17).
"Code NO? → " will be displayed.
2. Dial (01 through 20) or press the NEXT button.
Example:
When dial (01) or press the NEXT button.
 - The LCD will show "01:" when nothing is stored in memory location number "01".
 - When the phone number 1800 * * * has been stored, "01: 1800 * * *" will be displayed.
3. Dial the 7-digit phone number.
 - To erase a wrong entry, press the CLEAR button.
4. Press the MEMORY button.
 - The MEMORY indicator will be lit.
5.
 - To advance to the next memory location number, press the NEXT button.
 - To return to the previous memory location number, press the PREV button.
 - To go to a desired memory location number, press the SELECT button and dial the memory location number.
6. Repeat steps 3 to 5.
7. To return to the initial programming mode, press the END button.

Conditions

- Each phone number should consist of 7 digits.
- * substitutes for a number.

Programming Table

See page 28.

■ Applicable range to Service Class

Exceptional Code	Service Class			
	2	3	4	5
01	↑	↑	↑	↑
02	↑	↑	↑	↑
03	↑	↑	↑	↑
04	↑	↑	↑	↑
05	↑	↑	↑	↓
06				
↓				
10			↓	
11				
↓				
15		↓		
16				
↓				
20	↓			

Hold Recall Time Set

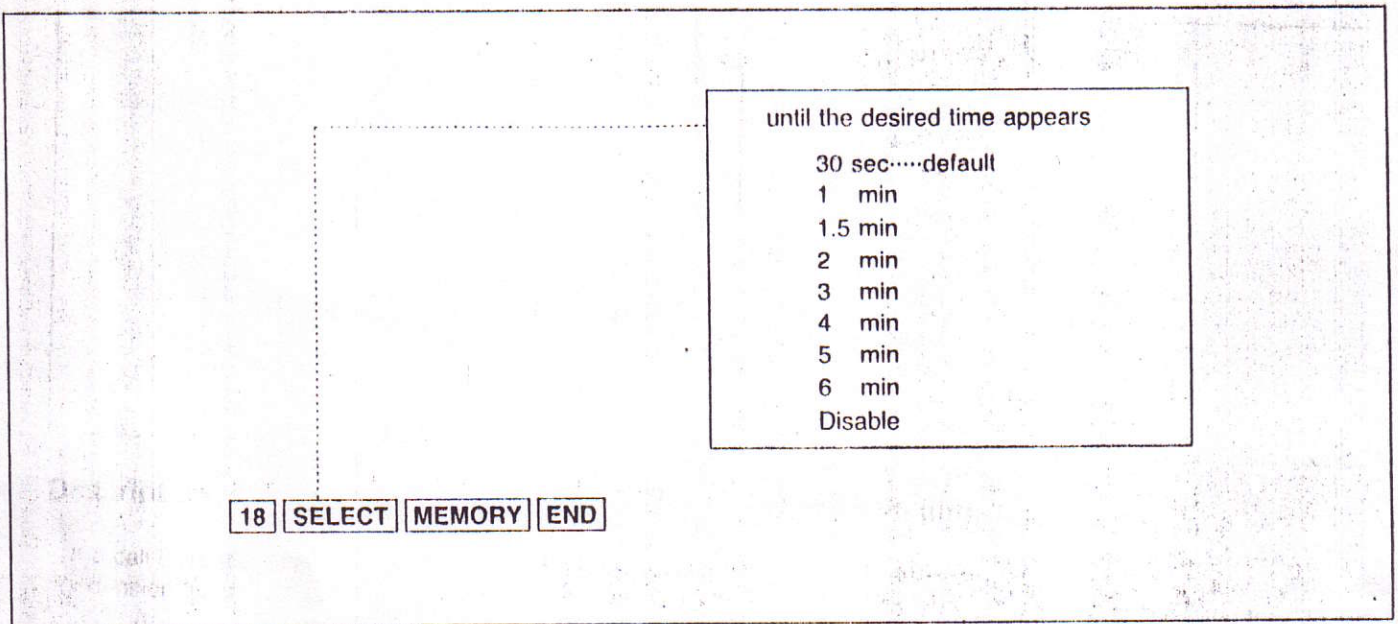

Description

When the handset of the holding extension is replaced on call, you may have the automatic hold recall after the desired time elapses. The hold recall can be removed or added.

Programming

1. Dial (18).
"Time: 30 sec" will be displayed and "30 sec" will blink.
2. Repeat pressing the SELECT button until the desired time is displayed.
3. Press the MEMORY button.
The LCD will stop blinking.
4. To return to the initial programming mode, press the END button.

Example:

1.5 minutes = 18 SELECT SELECT
MEMORY END

Programming Table

See page 28.

Transfer Recall Time

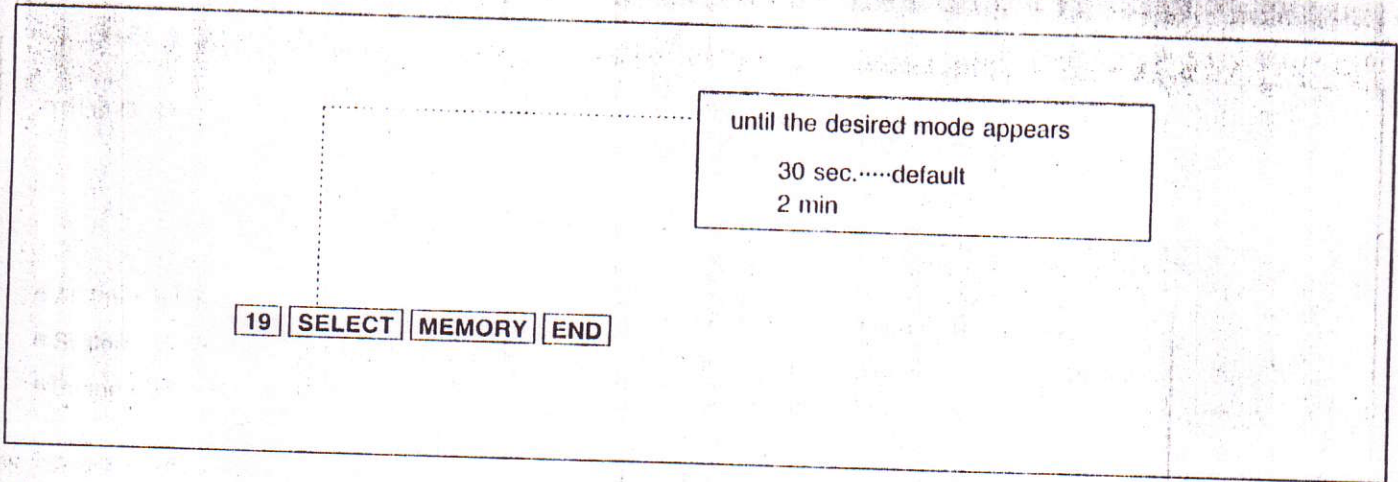

Description

If a call is transferred to an extension, and the other extension does not answer the transferred call within 30 seconds, the call will return to you. The time may be changed to 2 minutes.

Programming

1. Dial (19).
"Time: 30 sec" will be displayed and the "30 sec" will blink.
2. Press the SELECT button to alternate between "30 sec" and "2 min" to select the desired mode.
3. Press the MEMORY button.
The LCD will stop blinking.
4. To return to the initial programming mode, press the END button.

Programming Table

See page 28.

System Data Dump

● Stop Output

..... until the Stop Output appears

27 | **SELECT** | **MEMORY** | **END**

- All Parameters
- System Parameter
- Speed Dial

until desired data dump mode appears

All	Para	default
SystemPara			
CO	Para		
EXT	Para		
DSS	Para		
Speed Dial			
Stop	Output		

27 | **SELECT** | **MEMORY** | **END**

● CO Parameter (Outside)

..... until the CO Para appears

AB=	×	: to assign the same on all 12 CO's	
	0	1	: on CO 01
	⋮		
	1	2	: on CO 12

27 | **SELECT** | **MEMORY** | **AB** | **MEMORY** | **END**

● Extension Parameter

..... until the EXT Para appears

AB=	×	: to assign the same on all 32 jack numbers	
	0	1	: on jack number 01
	⋮		
	3	2	: on jack number 32

27 | **SELECT** | **MEMORY** | **AB** | **MEMORY** | **END**

● DSS Parameter

..... until the DSS Para appears

A=	×	: to assign the same on all 2 DSS's
	1	: on DSS 1
	⋮	
	2	: on DSS 2

27 | **SELECT** | **MEMORY** | **A** | **MEMORY** | **END**

Description

Six separate printouts are available.

They are (1) System parameters (2) CO parameters (3) Extension parameters (4) DSS parameters (5) Speed dial and (6) All parameters.

(1) System parameters

- [00] Date and Time Setting
- [02] Extension Number Assignment
- [03] Operator Extension
- [04] Paired Telephone Assignment for DSS Console
- [05] Automatic CO Transfer Using DSS Button
- [06] Day/Night Service Mode
- [07] Day/Night Starting Time
- [08] Call Hunting
- [09] Hunting Type
- [12] Toll Restriction of System Speed Dialing
- [13] Class-2 Denied Code Assignment
- [14] Class-3 Denied Code Assignment
- [15] Class-4 Denied Code Assignment
- [16] Class-5 Denied Code Assignment
- [17] Exceptional Code Assignment
- [18] Hold Recall Time Set
- [19] Transfer Recall Time
- [20] Call Forwarding Starting Time
- [21] Pickup Dial Delay Time
- [22] CO-to-CO Duration Time Limit
- [23] RS-232C Communication Parameters
- [24] SMDR Parameters
- [25] Incoming/Outgoing Call Selection for printing
- [26] Secret Speed Dial/One Touch Dial Printing
- [28] Duration Time Count Start Mode
- [29] External Paging Access Tone
- [30] DTMF Receiver Selection
- [31] Direct Inward System Access
- [32] Off Promise Extension
- [33] Off Hook Call Announcement
- [44] Trunk Group Assignment
- [70] Day Door-Phone
- [71] Night Door-Phone

(2) CO parameters

- [40] CO Connection Assignment
- [41] Dial Mode
- [42] Pulse Speed Selection
- [43] Host PBX Access Codes Assignment
- [44] Trunk Group Assignment
- [45] Flexible Outward Dialing Assignment-Day
- [46] Flexible Outward Dialing Assignment-Night
- [47] Flexible Ringing Assignment-Day
- [48] Flexible Ringing Assignment-Night
- [49] Delayed Ringing Assignment-Day
- [50] Delayed Ringing Assignment-Night
- [51] CO Day Mode Assignment
- [52] CO Night Mode Assignment
- [53] Pause Time Assignment
- [54] Hookswitch Flash Timing
- [55] Calling Party Control Signal
- [56] Disconnect Time
- [57] Automatic Designated CO Line Access

(3) Extension parameters

- [Type] Telephone Type
- [60] Extension Group Assignment
- [61] Service Class Assignment of Toll Restriction-Day
- [62] Service Class Assignment of Toll Restriction-Night
- [63] Extension Name
- [64] Account Code Input Mode
- [65] Call Transfer to Outside Line
- [66] Call Forwarding to Outside Line
- [67] Executive Override
- [68] Do not Disturb Override
- [69] Standard Telephone Connection with Proprietary Telephone
- [PF] Feature Button
- [CO] Flexible Key
- [MW] Flexible MW Key

● If KX-T30850 is connected to an extension, [CO] Flexible Keys 01 through 12 show the following button assignment.

- | | |
|------------------|------------------|
| [CO] 01 ... CO1 | [CO] 08 ... DSS4 |
| [CO] 02 ... CO2 | [CO] 09 ... DSS5 |
| [CO] 03 ... CO3 | [CO] 10 ... DSS6 |
| [CO] 05 ... DSS1 | [CO] 11 ... DSS7 |
| [CO] 06 ... DSS2 | [CO] 12 ... DSS8 |
| [CO] 07 ... DSS3 | |

(4) DSS Console parameters

- [Pair] Pair Extension No.
- [DS] DSS Button Assignments
- [PF] Programmable Feature Button

(5) Speed Dial

- [01] System Speed Dialing Entry
- Speed access codes (00 through 99) in which phone numbers are stored may be printed.

(6) All parameters

- System parameters
- CO parameters
- Extension parameters
- DSS parameters
- Speed Dial

Operation

To stop the printout:

1. Dial (27).
2. Repeat pressing the SELECT button until "Stop Output" is displayed.
3. Press the MEMORY button.

To print System Parameters, Speed Dial or All Parameters;

1. Dial (27).
"Menu: All Para" will be displayed and "All Para" will blink.
2. Repeat pressing the SELECT button until the desired data dump mode is displayed.
3. Press the MEMORY button.
SMDR printer will print out.
4. Repeat steps 2 to 3, to print the other data dumps.

To print CO Parameters;

1. Dial (27).
2. Repeat pressing the SELECT button until the "CO Para" is displayed.
3. Press the MEMORY button.
"CO NO ? → " is displayed.
4. Dial the CO number (01 through 12).
When dialing (01),
"CO NO ? → 01" will be displayed.
5. Press the MEMORY button.
SMDR printer will print out.
6. Repeat steps 4 to 5, to print the other CO parameter.

To print Extension Parameters;

1. Dial (27).
2. Repeat pressing the SELECT button until the "EXT Para" is displayed.
3. Press the MEMORY button.
"Jack NO ? → " will be displayed.
4. Dial the jack number (01 through 32).
When dialing (01),
"Jack NO ? → 01" will be displayed.
5. Press the MEMORY button.
SMDR printer will print out.
6. Repeat steps 4 to 5, to print the other jack number.

To print DSS Console Parameters;

1. Dial (27).
2. Repeat pressing the SELECT button until the "DSS Para" is displayed.
3. Press the MEMORY button.
"DSS NO ? → " will be displayed.
4. Dial the DSS number (1 or 2).
When dialing (1),
"DSS NO ? → 1" will be displayed.
5. Press the MEMORY button.
SMDR printer will print out.
6. Repeat steps 4 to 5, to print the other DSS Console parameter.

After completing printing, to return to the initial mode;

1. Press the END button.

Programming Table

See page 31.

Service Class Assignment of Toll Restriction

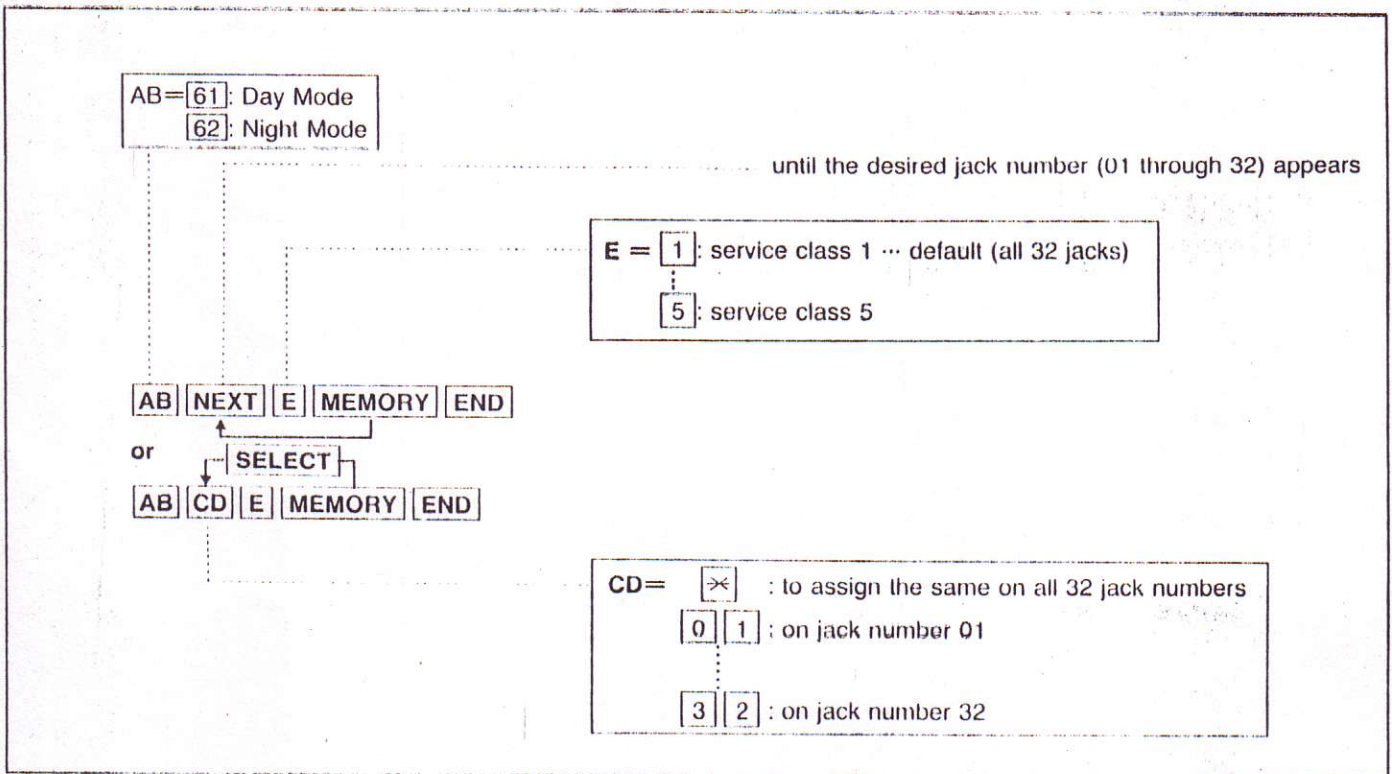

Description

Toll restriction can help eliminate telephone abuse and contribute to saving telephone costs. There are five service classes available for each extension.

	Service Class Selections	
	Allowed	Denied
1	All calls	
2	any calls other than denied dial number	20 codes programmed (Class 2 Denied Code other than exceptional cord)
3	any calls other than denied dial number	40 codes programmed (Class 2 and 3 Denied Code other than exceptional cord)
4	any calls other than denied dial number	60 codes programmed (Class 2, 3 and 4 Denied Code other than exceptional cord)
5	any calls other than denied dial number	80 codes programmed (Class 2, 3, 4 and 5 Denied Code other than exceptional cord)

Programming

1. ● Dial (61) for day mode.
● Dial (62) for night mode.
"Jack NO? →" will be displayed.
2. Press the NEXT button or dial the jack number (01 through 32).
"#01: Class-1" will be displayed and "1" will blink.
3. Press the service class number (1 through 5).
4. Press the MEMORY button.
The LCD will stop blinking.
5. ● To advance to the next jack number, press the NEXT button.
● To return to the previous jack number, press the PREV button.
● To go to a desired jack number, press the SELECT button and then dial the jack number.
6. Repeat steps 3 to 5, to program the assignment on the other jack numbers.
7. To return to the initial programming mode, press the END button.

Programming Table

See pages 47 and 48.

Example:

■ Application of denied dial number and exceptional dial number to service class 2, 3, 4 and 5.

Service Class	Denied Dial Number	Exceptional Dial Number
2	200 ××××	2201 ××× 2301 ××× 2401 ×××
3	200 ×××× 333 ××××	2301 ××× 2401 ×××
4	200 ×××× 333 ×××× 444 ××××	2401 ×××
5	200 ×××× 333 ×××× 444 ××××	

■ Entry of dial number to a code (memory location)

Class-2 Denied Code

Code	Dial No.
01	200 ××××
02	
20	

Class-3 Denied Code

Code	Dial No.
01	333 ××××
02	
20	

Class-4 Denied Code

Code	Dial No.
01	444 ××××
02	
20	

Class-5 Denied Code

Code	Dial No.
01	
20	

Exceptional Code

Code	Dial No.
01	
02	
03	
04	
05	
06	2401 ×××
07	
08	
09	
10	
11	2301 ×××
12	
13	
14	
15	
16	2201 ×××
17	
18	
19	
20	

● "F3-One Touch Button Mode Selection" is changed as follows.

F3-FWD/DND Button Selection for KX-T7050, KX-T123250, KX-T61650, KX-T30850

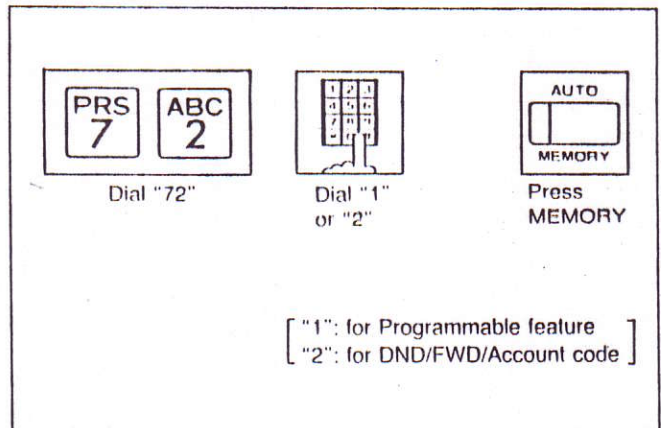

Description

The F3 button can be changed from programmable feature button to call forwarding/do not disturb/account code button.

- dial "1" mode programmable feature function
- dial "2" mode call forwarding/do not disturb/account code function

Operation

Setting

- Be sure the handset is in the cradle and the SP-PHONE button is off.
 - Set the MEMORY switch of the proprietary telephone (KX-T7050, KX-T123250, KX-T61650, KX-T30850) to "PROGRAM".
1. Dial (7) (2).
"Feature Button" will be displayed.
 2. Dial (1) for programmable feature function or dial (2) for call forwarding/do not disturb/account code function.
 3. Press the MEMORY button.
- After programming the F3 button, return the MEMORY switch to the "SET" position.

Cancelled Features

The following features are cancelled from KX-T123210DB/KX-T123210D.

Page of Installation Manual	Access code	Title
3-19	13	Area Code Selection-1
3-20	14	Area Code Selection-2
3-21	15	Area Code Selection-3
3-22	16	Area Code Selection-4
3-23	17	Hold Time Reminder

PROGRAMMING TABLE

TO SET	PROGRAM ADDRESS	STEPS REQUIRED TO CHANGE PROGRAM																																																																																																						
Date and Time Setting	00	<p style="text-align: center;"> AB ⇒ SELECT ⇒ CD ⇒ SELECT ⇒ EF ⇒ GH ⇒ SELECT MEMORY END </p> <p style="text-align: center;">yearmonthday day of the weekhourminuteAM / PM </p>																																																																																																						
System Speed Dialing Entry	01 OR AUTO	<p style="text-align: center;"> SELECT </p> <p style="text-align: center;"> AB CD phone number MEMORY END </p> <p style="text-align: center;"> : automatic line access number : access number of Trunk Group </p> <p style="text-align: center;">Speed access code (00 through 99) </p>																																																																																																						
Extension Number Assignment	02	<p style="text-align: center;"> NEXT CDE MEMORY END </p> <p style="text-align: center;">dial the extension number (100 through 199) until the desired jack number (01 through 32) appears </p> <table border="1" style="width: 100%; border-collapse: collapse; text-align: center;"> <tr> <td>Jack NO</td> <td>01</td><td>02</td><td>03</td><td>04</td><td>05</td><td>06</td><td>07</td><td>08</td><td>09</td><td>10</td><td>11</td><td>12</td><td>13</td><td>14</td><td>15</td><td>16</td> </tr> <tr> <td>EXT NO (default)</td> <td>101</td><td>102</td><td>103</td><td>104</td><td>105</td><td>106</td><td>107</td><td>108</td><td>109</td><td>110</td><td>111</td><td>112</td><td>113</td><td>114</td><td>115</td><td>116</td> </tr> <tr> <td>EXT NO (change)</td> <td></td><td></td><td></td><td></td><td></td><td></td><td></td><td></td><td></td><td></td><td></td><td></td><td></td><td></td><td></td><td></td> </tr> </table> <table border="1" style="width: 100%; border-collapse: collapse; text-align: center;"> <tr> <td>Jack NO</td> <td>17</td><td>18</td><td>19</td><td>20</td><td>21</td><td>22</td><td>23</td><td>24</td><td>25</td><td>26</td><td>27</td><td>28</td><td>29</td><td>30</td><td>31</td><td>32</td> </tr> <tr> <td>EXT NO (default)</td> <td>117</td><td>118</td><td>119</td><td>120</td><td>121</td><td>122</td><td>123</td><td>124</td><td>125</td><td>126</td><td>127</td><td>128</td><td>129</td><td>130</td><td>131</td><td>132</td> </tr> <tr> <td>EXT NO (change)</td> <td></td><td></td><td></td><td></td><td></td><td></td><td></td><td></td><td></td><td></td><td></td><td></td><td></td><td></td><td></td><td></td> </tr> </table>	Jack NO	01	02	03	04	05	06	07	08	09	10	11	12	13	14	15	16	EXT NO (default)	101	102	103	104	105	106	107	108	109	110	111	112	113	114	115	116	EXT NO (change)																	Jack NO	17	18	19	20	21	22	23	24	25	26	27	28	29	30	31	32	EXT NO (default)	117	118	119	120	121	122	123	124	125	126	127	128	129	130	131	132	EXT NO (change)																
Jack NO	01	02	03	04	05	06	07	08	09	10	11	12	13	14	15	16																																																																																								
EXT NO (default)	101	102	103	104	105	106	107	108	109	110	111	112	113	114	115	116																																																																																								
EXT NO (change)																																																																																																								
Jack NO	17	18	19	20	21	22	23	24	25	26	27	28	29	30	31	32																																																																																								
EXT NO (default)	117	118	119	120	121	122	123	124	125	126	127	128	129	130	131	132																																																																																								
EXT NO (change)																																																																																																								
Operator Assignment	03	<p style="text-align: center;"> NEXT AB MEMORY END </p> <p style="text-align: center;">dial the jack number set operator (01 through 32) until the desired operator number (1 or 2) appears </p> <table border="1" style="width: 100%; border-collapse: collapse; text-align: center;"> <tr> <td style="width: 50%;"></td> <td>Jack number set operator</td> </tr> <tr> <td>Operator 1</td> <td>01</td> </tr> </table> <table border="1" style="width: 100%; border-collapse: collapse; text-align: center;"> <tr> <td style="width: 50%;"></td> <td>Jack number set operator</td> </tr> <tr> <td>Operator 2</td> <td></td> </tr> </table>		Jack number set operator	Operator 1	01		Jack number set operator	Operator 2																																																																																															
	Jack number set operator																																																																																																							
Operator 1	01																																																																																																							
	Jack number set operator																																																																																																							
Operator 2																																																																																																								
Paired Telephone Assignment for DSS Console	04	<p style="text-align: center;"> NEXT AB MEMORY NEXT CD MEMORY END </p> <p style="text-align: center;">dial the jack number paired with console 2 (01 through 32) dial the jack number paired with console 1 (01 through 32) </p> <table border="1" style="width: 100%; border-collapse: collapse; text-align: center;"> <tr> <td style="width: 50%;"></td> <td>Jack number paired with Console 1</td> </tr> <tr> <td>Default</td> <td>01</td> </tr> <tr> <td>To make program change</td> <td></td> </tr> </table> <table border="1" style="width: 100%; border-collapse: collapse; text-align: center;"> <tr> <td style="width: 50%;"></td> <td>Jack number paired with Console 2</td> </tr> <tr> <td>Default</td> <td>02</td> </tr> <tr> <td>To make program change</td> <td></td> </tr> </table>		Jack number paired with Console 1	Default	01	To make program change			Jack number paired with Console 2	Default	02	To make program change																																																																																											
	Jack number paired with Console 1																																																																																																							
Default	01																																																																																																							
To make program change																																																																																																								
	Jack number paired with Console 2																																																																																																							
Default	02																																																																																																							
To make program change																																																																																																								
Automatic CO Transfer Using DSS Button	05	<p style="text-align: center;"> SELECT MEMORY END </p> <p style="text-align: center;">With Transfer / Without Transfer </p> <table border="1" style="width: 100%; border-collapse: collapse; text-align: center;"> <tr> <td style="width: 50%;"></td> <td>Default</td> <td>To make program change</td> </tr> <tr> <td>With Transfer</td> <td>x</td> <td></td> </tr> <tr> <td>Without Transfer</td> <td></td> <td></td> </tr> </table>		Default	To make program change	With Transfer	x		Without Transfer																																																																																															
	Default	To make program change																																																																																																						
With Transfer	x																																																																																																							
Without Transfer																																																																																																								

PROGRAMMING TABLE (cont.)

TO SET	PROGRAM ADDRESS	STEPS REQUIRED TO CHANGE PROGRAM																																																		
Day/Night Service Mode Switching of Service Mode	06	<p style="text-align: center;">SELECT MEMORY END</p> <p style="text-align: center;">..... Manual / Automatic</p> <table border="1" style="width: 100%; border-collapse: collapse;"> <thead> <tr> <th style="width: 30%;"></th> <th style="width: 30%;">Default</th> <th style="width: 40%;">To make program change</th> </tr> </thead> <tbody> <tr> <td>Manual</td> <td style="text-align: center;">X</td> <td></td> </tr> <tr> <td>Automatic</td> <td></td> <td></td> </tr> </tbody> </table>		Default	To make program change	Manual	X		Automatic																																											
	Default	To make program change																																																		
Manual	X																																																			
Automatic																																																				
Starting Time	07	<div style="text-align: center;"> <p>..... until the desired day of the week appears (If you press "SELECT")</p> <p>NEXT SELECT \Rightarrow AB \Rightarrow CD \Rightarrow SELECT MEMORY SELECT \Rightarrow</p> <p>..... minute AM / PM starting time for day service (hour)</p> <p>..... starting time for night service (hour) minute AM / PM EF \Rightarrow GH \Rightarrow SELECT MEMORY END (If you press "SELECT")</p> </div> <table border="1" style="width: 100%; border-collapse: collapse;"> <thead> <tr> <th style="width: 30%;"></th> <th style="width: 15%;">Default</th> <th colspan="4" style="width: 50%;">To make program change</th> </tr> <tr> <td></td> <td>all days of the week</td> <td>Sunday</td> <td>Monday</td> <td>Tuesday</td> <td>Wednesday</td> </tr> </thead> <tbody> <tr> <td>Day service</td> <td>9:00 AM</td> <td>NONE</td> <td>8:00 AM</td> <td></td> <td></td> </tr> <tr> <td>Night service</td> <td>5:00 PM</td> <td>9:30 PM</td> <td>5:30 PM</td> <td></td> <td></td> </tr> </tbody> </table> <table border="1" style="width: 100%; border-collapse: collapse;"> <thead> <tr> <th colspan="3" style="text-align: center;">To make program change</th> </tr> <tr> <th style="width: 33%;">Thursday</th> <th style="width: 33%;">Friday</th> <th style="width: 33%;">Saturday</th> </tr> </thead> <tbody> <tr> <td> </td> <td> </td> <td> </td> </tr> </tbody> </table>		Default	To make program change					all days of the week	Sunday	Monday	Tuesday	Wednesday	Day service	9:00 AM	NONE	8:00 AM			Night service	5:00 PM	9:30 PM	5:30 PM			To make program change			Thursday	Friday	Saturday																				
	Default	To make program change																																																		
	all days of the week	Sunday	Monday	Tuesday	Wednesday																																															
Day service	9:00 AM	NONE	8:00 AM																																																	
Night service	5:00 PM	9:30 PM	5:30 PM																																																	
To make program change																																																				
Thursday	Friday	Saturday																																																		
Call Hunting Setting	08	<p style="text-align: center;">NEXT SELECT MEMORY END</p> <p style="text-align: center;">..... Disable / Enable</p> <p style="text-align: center;">..... until the desired extension group number (1 through 8) appears</p> <table border="1" style="width: 100%; border-collapse: collapse;"> <thead> <tr> <th style="width: 30%;"></th> <th style="width: 15%;">Default</th> <th colspan="8" style="width: 55%;">To make program change</th> </tr> <tr> <td></td> <td>all 8 extension groups</td> <th colspan="8" style="text-align: center;">Extension group</th> </tr> <tr> <td></td> <td></td> <th>group 1</th> <th>group 2</th> <th>group 3</th> <th>group 4</th> <th>group 5</th> <th>group 6</th> <th>group 7</th> <th>group 8</th> </tr> </thead> <tbody> <tr> <td>Disable</td> <td style="text-align: center;">X</td> <td></td> <td></td> <td></td> <td></td> <td></td> <td></td> <td></td> <td></td> </tr> <tr> <td>Enable</td> <td></td> <td></td> <td></td> <td></td> <td></td> <td></td> <td></td> <td></td> <td></td> </tr> </tbody> </table>		Default	To make program change									all 8 extension groups	Extension group										group 1	group 2	group 3	group 4	group 5	group 6	group 7	group 8	Disable	X									Enable									
	Default	To make program change																																																		
	all 8 extension groups	Extension group																																																		
		group 1	group 2	group 3	group 4	group 5	group 6	group 7	group 8																																											
Disable	X																																																			
Enable																																																				
Hunting Type	09	<p style="text-align: center;">NEXT SELECT MEMORY END</p> <p style="text-align: center;">..... Terminate / Circular</p> <p style="text-align: center;">..... until the desired extension group number (1 through 8) appears</p> <table border="1" style="width: 100%; border-collapse: collapse;"> <thead> <tr> <th style="width: 30%;"></th> <th style="width: 15%;">Default</th> <th colspan="8" style="width: 55%;">To make program change</th> </tr> <tr> <td></td> <td>all 8 extension groups</td> <th colspan="8" style="text-align: center;">Extension group</th> </tr> <tr> <td></td> <td></td> <th>group 1</th> <th>group 2</th> <th>group 3</th> <th>group 4</th> <th>group 5</th> <th>group 6</th> <th>group 7</th> <th>group 8</th> </tr> </thead> <tbody> <tr> <td>Terminate</td> <td style="text-align: center;">X</td> <td></td> <td></td> <td></td> <td></td> <td></td> <td></td> <td></td> <td></td> </tr> <tr> <td>Circular</td> <td></td> <td></td> <td></td> <td></td> <td></td> <td></td> <td></td> <td></td> <td></td> </tr> </tbody> </table>		Default	To make program change									all 8 extension groups	Extension group										group 1	group 2	group 3	group 4	group 5	group 6	group 7	group 8	Terminate	X									Circular									
	Default	To make program change																																																		
	all 8 extension groups	Extension group																																																		
		group 1	group 2	group 3	group 4	group 5	group 6	group 7	group 8																																											
Terminate	X																																																			
Circular																																																				

TO SET	PROGRAM ADDRESS	STEPS REQUIRED TO CHANGE PROGRAM																																					
Toll Restriction - System Speed Dialing	12	<p>SELECT MEMORY END</p> <p>CLASS1/CLASS2/CLASS3/CLASS4/CLASS5</p> <table border="1"> <thead> <tr> <th></th> <th>Default</th> <th>To make program change</th> </tr> </thead> <tbody> <tr> <td>CLASS 1</td> <td>X</td> <td></td> </tr> <tr> <td>CLASS 2</td> <td></td> <td></td> </tr> <tr> <td>CLASS 3</td> <td></td> <td></td> </tr> <tr> <td>CLASS 4</td> <td></td> <td></td> </tr> <tr> <td>CLASS 5</td> <td></td> <td></td> </tr> </tbody> </table>		Default	To make program change	CLASS 1	X		CLASS 2			CLASS 3			CLASS 4			CLASS 5																					
	Default	To make program change																																					
CLASS 1	X																																						
CLASS 2																																							
CLASS 3																																							
CLASS 4																																							
CLASS 5																																							
Toll Restriction - Class 2 Denied Code Assignment	13	<p>NEXT E MEMORY END</p> <p>phone number with 7 digits until the desired memory location number (01 through 20) appears</p> <table border="1"> <thead> <tr> <th rowspan="2"></th> <th colspan="5">Memory location number</th> </tr> <tr> <th>01</th> <th>02</th> <th>03</th> <th>04</th> <th>05</th> </tr> </thead> <tbody> <tr> <td rowspan="5">Phone number entry</td> <td>100 ****</td> <td></td> <td></td> <td></td> <td></td> </tr> <tr> <td>06</td> <td>07</td> <td>08</td> <td>09</td> <td>10</td> </tr> <tr> <td>11</td> <td>12</td> <td>13</td> <td>14</td> <td>15</td> </tr> <tr> <td>16</td> <td>17</td> <td>18</td> <td>19</td> <td>20</td> </tr> <tr> <td></td> <td></td> <td></td> <td></td> <td></td> </tr> </tbody> </table>		Memory location number					01	02	03	04	05	Phone number entry	100 ****					06	07	08	09	10	11	12	13	14	15	16	17	18	19	20					
	Memory location number																																						
	01	02	03	04	05																																		
Phone number entry	100 ****																																						
	06	07	08	09	10																																		
	11	12	13	14	15																																		
	16	17	18	19	20																																		
- Class 3 Denied Code Assignment	14	<p>NEXT E MEMORY END</p> <p>phone number with 7 digits until the desired memory location number (01 through 20) appears</p> <table border="1"> <thead> <tr> <th rowspan="2"></th> <th colspan="5">Memory location number</th> </tr> <tr> <th>01</th> <th>02</th> <th>03</th> <th>04</th> <th>05</th> </tr> </thead> <tbody> <tr> <td rowspan="5">Phone number entry</td> <td>001 ****</td> <td></td> <td></td> <td></td> <td></td> </tr> <tr> <td>06</td> <td>07</td> <td>08</td> <td>09</td> <td>10</td> </tr> <tr> <td>11</td> <td>12</td> <td>13</td> <td>14</td> <td>15</td> </tr> <tr> <td>16</td> <td>17</td> <td>18</td> <td>19</td> <td>20</td> </tr> <tr> <td></td> <td></td> <td></td> <td></td> <td></td> </tr> </tbody> </table>		Memory location number					01	02	03	04	05	Phone number entry	001 ****					06	07	08	09	10	11	12	13	14	15	16	17	18	19	20					
	Memory location number																																						
	01	02	03	04	05																																		
Phone number entry	001 ****																																						
	06	07	08	09	10																																		
	11	12	13	14	15																																		
	16	17	18	19	20																																		
- Class 4 Denied Code Assignment	15	<p>NEXT E MEMORY END</p> <p>phone number with 7 digits until the desired memory location number (01 through 20) appears</p> <table border="1"> <thead> <tr> <th rowspan="2"></th> <th colspan="5">Memory location number</th> </tr> <tr> <th>01</th> <th>02</th> <th>03</th> <th>04</th> <th>05</th> </tr> </thead> <tbody> <tr> <td rowspan="5">Phone number entry</td> <td></td> <td></td> <td></td> <td></td> <td></td> </tr> <tr> <td>06</td> <td>07</td> <td>08</td> <td>09</td> <td>10</td> </tr> <tr> <td>11</td> <td>12</td> <td>13</td> <td>14</td> <td>15</td> </tr> <tr> <td>16</td> <td>17</td> <td>18</td> <td>19</td> <td>20</td> </tr> <tr> <td></td> <td></td> <td></td> <td></td> <td></td> </tr> </tbody> </table>		Memory location number					01	02	03	04	05	Phone number entry						06	07	08	09	10	11	12	13	14	15	16	17	18	19	20					
	Memory location number																																						
	01	02	03	04	05																																		
Phone number entry																																							
	06	07	08	09	10																																		
	11	12	13	14	15																																		
	16	17	18	19	20																																		

PROGRAMMING TABLE (cont.)

TO SET	PROGRAM ADDRESS	STEPS REQUIRED TO CHANGE PROGRAM																																											
- Class 5 Denied Codes Assignment	16	<p style="text-align: center;"> NEXT E MEMORY END </p> <p style="text-align: center;"> phone number with 7 digits until the desired memory location number (01 through 20) appears </p> <table border="1" style="width: 100%; border-collapse: collapse; text-align: center;"> <thead> <tr> <th style="width: 10%;"></th> <th colspan="5">Memory location number</th> </tr> <tr> <th></th> <th>01</th> <th>02</th> <th>03</th> <th>04</th> <th>05</th> </tr> </thead> <tbody> <tr> <td rowspan="6" style="text-align: left; vertical-align: middle;">Phone number entry</td> <td>02</td> <td>* * *</td> <td></td> <td></td> <td></td> </tr> <tr> <td>06</td> <td></td> <td></td> <td></td> <td></td> </tr> <tr> <td>11</td> <td></td> <td></td> <td></td> <td></td> </tr> <tr> <td>16</td> <td></td> <td></td> <td></td> <td></td> </tr> <tr> <td>19</td> <td></td> <td></td> <td></td> <td></td> </tr> <tr> <td>20</td> <td></td> <td></td> <td></td> <td></td> </tr> </tbody> </table>		Memory location number						01	02	03	04	05	Phone number entry	02	* * *				06					11					16					19					20				
	Memory location number																																												
	01	02	03	04	05																																								
Phone number entry	02	* * *																																											
	06																																												
	11																																												
	16																																												
	19																																												
	20																																												
Toll Restriction - Exceptional Code Assignment	17	<p style="text-align: center;"> NEXT AB C MEMORY END </p> <p style="text-align: center;"> phone number with 7 digits until the desired memory location number (01 through 20) appears </p> <table border="1" style="width: 100%; border-collapse: collapse; text-align: center;"> <thead> <tr> <th style="width: 10%;"></th> <th colspan="5">Memory location number</th> </tr> <tr> <th></th> <th>01</th> <th>02</th> <th>03</th> <th>04</th> <th>05</th> </tr> </thead> <tbody> <tr> <td rowspan="6" style="text-align: left; vertical-align: middle;">Phone number entry</td> <td>02</td> <td>51405</td> <td></td> <td></td> <td></td> </tr> <tr> <td>06</td> <td></td> <td></td> <td></td> <td></td> </tr> <tr> <td>11</td> <td></td> <td></td> <td></td> <td></td> </tr> <tr> <td>16</td> <td></td> <td></td> <td></td> <td></td> </tr> <tr> <td>19</td> <td></td> <td></td> <td></td> <td></td> </tr> <tr> <td>20</td> <td></td> <td></td> <td></td> <td></td> </tr> </tbody> </table>		Memory location number						01	02	03	04	05	Phone number entry	02	51405				06					11					16					19					20				
	Memory location number																																												
	01	02	03	04	05																																								
Phone number entry	02	51405																																											
	06																																												
	11																																												
	16																																												
	19																																												
	20																																												
Hold Recall Time Set	18	<p style="text-align: center;"> SELECT MEMORY END </p> <p style="text-align: center;"> 30 sec / 1 min / 1.5 min / 2 min / 3 min / 4 min / 5 min / 6 min / Disable </p> <table border="1" style="width: 100%; border-collapse: collapse; text-align: center;"> <thead> <tr> <th style="width: 10%;"></th> <th>30 seconds</th> <th>1 minutes</th> <th>1.5 minutes</th> <th>2 minutes</th> <th>3 minutes</th> <th>4 minutes</th> <th>5 minutes</th> <th>6 minutes</th> <th>Disable</th> </tr> </thead> <tbody> <tr> <td>Default</td> <td>X</td> <td></td> <td></td> <td></td> <td></td> <td></td> <td></td> <td></td> <td></td> </tr> <tr> <td>To make program change</td> <td></td> <td></td> <td></td> <td></td> <td></td> <td></td> <td></td> <td></td> <td></td> </tr> </tbody> </table>		30 seconds	1 minutes	1.5 minutes	2 minutes	3 minutes	4 minutes	5 minutes	6 minutes	Disable	Default	X									To make program change																						
	30 seconds	1 minutes	1.5 minutes	2 minutes	3 minutes	4 minutes	5 minutes	6 minutes	Disable																																				
Default	X																																												
To make program change																																													
Transfer Recall Time	19	<p style="text-align: center;"> SELECT MEMORY END </p> <p style="text-align: center;"> 30 sec / 2 min </p> <table border="1" style="width: 100%; border-collapse: collapse; text-align: center;"> <thead> <tr> <th style="width: 10%;"></th> <th>Default</th> <th>To make program change</th> </tr> </thead> <tbody> <tr> <td>30 sec</td> <td>X</td> <td></td> </tr> <tr> <td>2 min</td> <td></td> <td></td> </tr> </tbody> </table>		Default	To make program change	30 sec	X		2 min																																				
	Default	To make program change																																											
30 sec	X																																												
2 min																																													

TO SET	PROGRAM ADDRESS	STEPS REQUIRED TO CHANGE PROGRAM																																													
Call Forwarding Starting Time	20	<p>SELECT MEMORY END 1 ring delay / 2 rings delay / 3 rings delay / 4 rings delay</p> <table border="1"> <thead> <tr> <th></th> <th>Default</th> <th>To make program change</th> </tr> </thead> <tbody> <tr> <td>1 ring delay</td> <td></td> <td></td> </tr> <tr> <td>2 rings delay</td> <td></td> <td></td> </tr> <tr> <td>3 rings delay</td> <td>X</td> <td></td> </tr> <tr> <td>4 rings delay</td> <td></td> <td></td> </tr> </tbody> </table>		Default	To make program change	1 ring delay			2 rings delay			3 rings delay	X		4 rings delay																																
	Default	To make program change																																													
1 ring delay																																															
2 rings delay																																															
3 rings delay	X																																														
4 rings delay																																															
Pickup Dial Delay Time	21	<p>SELECT MEMORY END 1 sec / 2 sec / 3 sec / 4 sec</p> <table border="1"> <thead> <tr> <th></th> <th>Default</th> <th>To make program change</th> </tr> </thead> <tbody> <tr> <td>1 sec</td> <td></td> <td></td> </tr> <tr> <td>2 sec</td> <td></td> <td></td> </tr> <tr> <td>3 sec</td> <td>X</td> <td></td> </tr> <tr> <td>4 sec</td> <td></td> <td></td> </tr> </tbody> </table>		Default	To make program change	1 sec			2 sec			3 sec	X		4 sec																																
	Default	To make program change																																													
1 sec																																															
2 sec																																															
3 sec	X																																														
4 sec																																															
CO-to-CO Duration Time Limit	22	<p>AP MEMORY END dial the time (1 minute through 32 minutes)</p> <table border="1"> <thead> <tr> <th></th> <th>Default</th> <th>To make program change</th> </tr> </thead> <tbody> <tr> <td>minute</td> <td>10</td> <td></td> </tr> </tbody> </table>		Default	To make program change	minute	10																																								
	Default	To make program change																																													
minute	10																																														
SMDR RS-232C Communication Parameters	23	<p>(Carriage return for a new line) SELECT MEMORY CR + LF / CR</p> <table border="1"> <thead> <tr> <th></th> <th>Default</th> <th>To make program change</th> </tr> </thead> <tbody> <tr> <td>CR + LF</td> <td>X</td> <td></td> </tr> <tr> <td>CR</td> <td></td> <td></td> </tr> </tbody> </table> <p>(Baud rate) NEXT SELECT MEMORY 110B / 150B / 300B / 600B / 1200B / 2400B / 4800B / 9600B</p> <table border="1"> <thead> <tr> <th></th> <th>110B</th> <th>150B</th> <th>300B</th> <th>600B</th> <th>1200B</th> <th>2400B</th> <th>4800B</th> <th>9600B</th> </tr> </thead> <tbody> <tr> <td>Default</td> <td></td> <td></td> <td></td> <td></td> <td>X</td> <td></td> <td></td> <td></td> </tr> <tr> <td>To make program change</td> <td></td> <td></td> <td></td> <td></td> <td></td> <td></td> <td></td> <td></td> </tr> </tbody> </table> <p>(Word length) NEXT SELECT MEMORY 7 bits / 8 bits</p> <table border="1"> <thead> <tr> <th></th> <th>Default</th> <th>To make program change</th> </tr> </thead> <tbody> <tr> <td>7 bits</td> <td>X</td> <td></td> </tr> <tr> <td>8 bits</td> <td></td> <td></td> </tr> </tbody> </table>		Default	To make program change	CR + LF	X		CR				110B	150B	300B	600B	1200B	2400B	4800B	9600B	Default					X				To make program change										Default	To make program change	7 bits	X		8 bits		
	Default	To make program change																																													
CR + LF	X																																														
CR																																															
	110B	150B	300B	600B	1200B	2400B	4800B	9600B																																							
Default					X																																										
To make program change																																															
	Default	To make program change																																													
7 bits	X																																														
8 bits																																															

PROGRAMMING TABLE (cont.)

TO SET	PROGRAM ADDRESS	STEPS REQUIRED TO CHANGE PROGRAM																											
SMDR (cont.)	23	<p>(Parity)</p> <p>NEXT SELECT MEMORY END None / Mark / Space / Even / Odd</p> <table border="1" style="width: 100%; border-collapse: collapse;"> <thead> <tr> <th style="width: 40%;"></th> <th style="width: 15%;">None</th> <th style="width: 15%;">Mark</th> <th style="width: 15%;">Space</th> <th style="width: 15%;">Even</th> <th style="width: 15%;">Odd</th> </tr> </thead> <tbody> <tr> <td>Default</td> <td></td> <td></td> <td></td> <td></td> <td></td> </tr> <tr> <td>To make program change</td> <td></td> <td></td> <td></td> <td></td> <td></td> </tr> </tbody> </table> <p>(Stop bit length)</p> <p>NEXT SELECT MEMORY END 1 bit / 2 bits</p> <table border="1" style="width: 100%; border-collapse: collapse;"> <thead> <tr> <th style="width: 30%;"></th> <th style="width: 35%;">Default</th> <th style="width: 35%;">To make program change</th> </tr> </thead> <tbody> <tr> <td>1 bit</td> <td style="text-align: center;">x</td> <td></td> </tr> <tr> <td>2 bits</td> <td></td> <td></td> </tr> </tbody> </table>		None	Mark	Space	Even	Odd	Default						To make program change							Default	To make program change	1 bit	x		2 bits		
	None	Mark	Space	Even	Odd																								
Default																													
To make program change																													
	Default	To make program change																											
1 bit	x																												
2 bits																													
SMDR Parameters	24	<p>(Page length)</p> <p>AB MEMORY 4 through 99 lines</p> <table border="1" style="width: 100%; border-collapse: collapse;"> <thead> <tr> <th style="width: 40%;"></th> <th style="width: 30%;">Default</th> <th style="width: 30%;">To make program change</th> </tr> </thead> <tbody> <tr> <td>Lines per page</td> <td style="text-align: center;">66</td> <td></td> </tr> </tbody> </table> <p>(Skip perforation)</p> <p>NEXT AB MEMORY END 0 through 95 lines</p> <table border="1" style="width: 100%; border-collapse: collapse;"> <thead> <tr> <th style="width: 40%;"></th> <th style="width: 30%;">Default</th> <th style="width: 30%;">To make program change</th> </tr> </thead> <tbody> <tr> <td>Skipping lines</td> <td style="text-align: center;">0</td> <td></td> </tr> </tbody> </table>		Default	To make program change	Lines per page	66			Default	To make program change	Skipping lines	0																
	Default	To make program change																											
Lines per page	66																												
	Default	To make program change																											
Skipping lines	0																												
Incoming/ Outgoing Call Selection for printing	25	<p>SELECT MEMORY NEXT SELECT MEMORY END Outgoing : On/ Off Incoming : On/ Off</p> <table border="1" style="width: 100%; border-collapse: collapse;"> <thead> <tr> <th rowspan="2" style="width: 40%;"></th> <th colspan="2" style="width: 20%;">Outgoing</th> <th colspan="2" style="width: 20%;">Incoming</th> </tr> <tr> <th style="width: 10%;">ON</th> <th style="width: 10%;">OFF</th> <th style="width: 10%;">ON</th> <th style="width: 10%;">OFF</th> </tr> </thead> <tbody> <tr> <td>Default</td> <td style="text-align: center;">x</td> <td></td> <td style="text-align: center;">x</td> <td></td> </tr> <tr> <td>To make program change</td> <td></td> <td></td> <td></td> <td></td> </tr> </tbody> </table>		Outgoing		Incoming		ON	OFF	ON	OFF	Default	x		x		To make program change												
	Outgoing			Incoming																									
	ON	OFF	ON	OFF																									
Default	x		x																										
To make program change																													
Secret Speed Dial / One Touch Dial Printing	26	<p>SELECT MEMORY END No Printing / Printing</p> <table border="1" style="width: 100%; border-collapse: collapse;"> <thead> <tr> <th style="width: 40%;"></th> <th style="width: 30%;">Default</th> <th style="width: 30%;">To make program change</th> </tr> </thead> <tbody> <tr> <td>No Printing</td> <td style="text-align: center;">x</td> <td></td> </tr> <tr> <td>Printing</td> <td></td> <td></td> </tr> </tbody> </table>		Default	To make program change	No Printing	x		Printing																				
	Default	To make program change																											
No Printing	x																												
Printing																													

PROGRAMMING TABLE (cont.)

TO SET	PROGRAM ADDRESS	STEPS REQUIRED TO CHANGE PROGRAM																																																																																	
Direct Inward System Access (DISA)	31	<p>(Control code "x")</p> <p>SELECT SELECT MEMORY</p> <p style="text-align: center;">..... Enable / Disable</p> <table border="1" style="width: 100%; border-collapse: collapse;"> <thead> <tr> <th></th> <th style="text-align: center;">Default</th> <th style="text-align: center;">To make program change</th> </tr> </thead> <tbody> <tr> <td>Enable</td> <td style="text-align: center;">X</td> <td></td> </tr> <tr> <td>Disable</td> <td></td> <td></td> </tr> </tbody> </table> <p>(Prolong time)</p> <p>NEXT SELECT SELECT MEMORY</p> <p style="text-align: center;">..... 2 min / 3 min / 4 min / 5 min</p> <table border="1" style="width: 100%; border-collapse: collapse;"> <thead> <tr> <th></th> <th style="text-align: center;">2 minutes</th> <th style="text-align: center;">3 minutes</th> <th style="text-align: center;">4 minutes</th> <th style="text-align: center;">5 minutes</th> </tr> </thead> <tbody> <tr> <td>Default</td> <td></td> <td></td> <td></td> <td style="text-align: center;">X</td> </tr> <tr> <td>To make program change</td> <td></td> <td></td> <td></td> <td></td> </tr> </tbody> </table> <p>(Answer delay time)</p> <p>NEXT SELECT SELECT MEMORY</p> <p style="text-align: center;">..... 0 sec / 5 sec / 10 sec / 15 sec</p> <table border="1" style="width: 100%; border-collapse: collapse;"> <thead> <tr> <th></th> <th style="text-align: center;">0 second</th> <th style="text-align: center;">5 seconds</th> <th style="text-align: center;">10 seconds</th> <th style="text-align: center;">15 seconds</th> </tr> </thead> <tbody> <tr> <td>Default</td> <td></td> <td></td> <td style="text-align: center;">X</td> <td></td> </tr> <tr> <td>To make program change</td> <td></td> <td></td> <td></td> <td></td> </tr> </tbody> </table> <p>(Tone detect)</p> <p>NEXT SELECT SELECT MEMORY</p> <p style="text-align: center;">..... Enable / Disable</p> <table border="1" style="width: 100%; border-collapse: collapse;"> <thead> <tr> <th></th> <th style="text-align: center;">Default</th> <th style="text-align: center;">To make program change</th> </tr> </thead> <tbody> <tr> <td>Enable</td> <td style="text-align: center;">X</td> <td></td> </tr> <tr> <td>Disable</td> <td></td> <td></td> </tr> </tbody> </table> <p>(Security type)</p> <p>NEXT SELECT SELECT MEMORY</p> <p style="text-align: center;">..... None Security / Trunk Security / All Security</p> <table border="1" style="width: 100%; border-collapse: collapse;"> <thead> <tr> <th></th> <th style="text-align: center;">None Security</th> <th style="text-align: center;">Trunk Security</th> <th style="text-align: center;">All Security</th> </tr> </thead> <tbody> <tr> <td>Default</td> <td></td> <td style="text-align: center;">X</td> <td></td> </tr> <tr> <td>To make program change</td> <td></td> <td></td> <td></td> </tr> </tbody> </table> <p>(Remote security code)</p> <p>NEXT SELECT CODE No. MEMORY</p> <p style="text-align: center;">..... 4 digits (0000 through 9999)</p> <table border="1" style="width: 100%; border-collapse: collapse;"> <thead> <tr> <th></th> <th style="text-align: center;">Default</th> <th style="text-align: center;">To make program change</th> </tr> </thead> <tbody> <tr> <td></td> <td style="text-align: center;">70000</td> <td></td> </tr> </tbody> </table> <p>(User security code)</p> <p>NEXT SELECT SELECT CODE No. MEMORY END</p> <p style="text-align: center;">..... 4 digits (0000 through 9999)</p> <p style="text-align: center;">..... User Code 1 / User Code 2 / User Code 3 / User Code 4</p> <table border="1" style="width: 100%; border-collapse: collapse;"> <thead> <tr> <th></th> <th style="text-align: center;">Default</th> <th style="text-align: center;">To make program change</th> </tr> </thead> <tbody> <tr> <td>User code 1</td> <td style="text-align: center;">60000</td> <td></td> </tr> <tr> <td>User code 2</td> <td style="text-align: center;">60000</td> <td></td> </tr> <tr> <td>User code 3</td> <td style="text-align: center;">60000</td> <td></td> </tr> <tr> <td>User code 4</td> <td style="text-align: center;">60000</td> <td></td> </tr> </tbody> </table>		Default	To make program change	Enable	X		Disable				2 minutes	3 minutes	4 minutes	5 minutes	Default				X	To make program change						0 second	5 seconds	10 seconds	15 seconds	Default			X		To make program change						Default	To make program change	Enable	X		Disable				None Security	Trunk Security	All Security	Default		X		To make program change					Default	To make program change		70000			Default	To make program change	User code 1	60000		User code 2	60000		User code 3	60000		User code 4	60000	
	Default	To make program change																																																																																	
Enable	X																																																																																		
Disable																																																																																			
	2 minutes	3 minutes	4 minutes	5 minutes																																																																															
Default				X																																																																															
To make program change																																																																																			
	0 second	5 seconds	10 seconds	15 seconds																																																																															
Default			X																																																																																
To make program change																																																																																			
	Default	To make program change																																																																																	
Enable	X																																																																																		
Disable																																																																																			
	None Security	Trunk Security	All Security																																																																																
Default		X																																																																																	
To make program change																																																																																			
	Default	To make program change																																																																																	
	70000																																																																																		
	Default	To make program change																																																																																	
User code 1	60000																																																																																		
User code 2	60000																																																																																		
User code 3	60000																																																																																		
User code 4	60000																																																																																		

TO SET	PROGRAM ADDRESS	STEPS REQUIRED TO CHANGE PROGRAM																				
SMDER (cont.) System Data Dump	27	<ul style="list-style-type: none"> • All Parameters • System Parameter • Speed Dial • Stop Output <p style="text-align: center;"> SELECT MEMORY END </p> <p style="text-align: center;">..... All Para / System Para / Speed Dial / Stop Output</p> <ul style="list-style-type: none"> • CO Parameter <p style="text-align: center;"> SELECT MEMORY AB MEMORY END </p> <p style="text-align: center;">..... dial the CO number (01 through 12) until the CO Para appears</p> <ul style="list-style-type: none"> • Extension Parameter <p style="text-align: center;"> SELECT MEMORY AB MEMORY END </p> <p style="text-align: center;">..... dial jack number (01 through 32) until the EXT Para appears</p> <ul style="list-style-type: none"> • DSS Parameter <p style="text-align: center;"> SELECT MEMORY A MEMORY END </p> <p style="text-align: center;">..... dial DSS number (1 or 2) until the DSS Para appears</p>																				
Duration Time Count Start Mode	28	<p style="text-align: center;"> SELECT MEMORY END </p> <p style="text-align: center;">..... Instantly / 5s after dial / 10s after dial / 15s after dial</p> <table border="1" style="width: 100%; border-collapse: collapse;"> <thead> <tr> <th style="width: 30%;"></th> <th style="width: 35%;">Default</th> <th colspan="2" style="width: 35%;">To make program change</th> </tr> </thead> <tbody> <tr> <td>Instantly</td> <td></td> <td></td> <td></td> </tr> <tr> <td>5s after dial</td> <td></td> <td></td> <td></td> </tr> <tr> <td>10s after dial</td> <td></td> <td></td> <td></td> </tr> <tr> <td>15s after dial</td> <td></td> <td></td> <td></td> </tr> </tbody> </table>		Default	To make program change		Instantly				5s after dial				10s after dial				15s after dial			
	Default	To make program change																				
Instantly																						
5s after dial																						
10s after dial																						
15s after dial																						
External Paging Access Tone	29	<p style="text-align: center;"> NEXT SELECT MEMORY END </p> <p style="text-align: center;">..... Enable / Disable until the desired external paging equipment number (1 or 2) appears</p> <table border="1" style="width: 100%; border-collapse: collapse;"> <thead> <tr> <th rowspan="2" style="width: 30%;"></th> <th style="width: 20%;">Default</th> <th colspan="2" style="width: 50%;">To make program change</th> </tr> <tr> <th>External paging 1 and 2</th> <th colspan="2">External paging equipment</th> </tr> <tr> <td></td> <td></td> <th style="width: 25%;">1</th> <th style="width: 25%;">2</th> </tr> </thead> <tbody> <tr> <td>Enable</td> <td style="text-align: center;">x</td> <td></td> <td></td> </tr> <tr> <td>Disable</td> <td></td> <td></td> <td></td> </tr> </tbody> </table>		Default	To make program change		External paging 1 and 2	External paging equipment				1	2	Enable	x			Disable				
	Default	To make program change																				
	External paging 1 and 2	External paging equipment																				
		1	2																			
Enable	x																					
Disable																						
DTMF Receiver check	30	<p style="text-align: center;"> NEXT SELECT MEMORY END </p> <p style="text-align: center;">..... Enable/Disable until the desired DTMF receiver appears</p> <table border="1" style="width: 100%; border-collapse: collapse;"> <thead> <tr> <th style="width: 30%;"></th> <th style="width: 20%;">Default</th> <th colspan="3" style="width: 50%;">To make program change</th> </tr> </thead> <tbody> <tr> <td>DTMF receiver</td> <td>1, 2, 3</td> <td>1</td> <td>(2)</td> <td>3</td> </tr> <tr> <td>Enable</td> <td style="text-align: center;">x</td> <td></td> <td></td> <td></td> </tr> <tr> <td>Disable</td> <td></td> <td></td> <td></td> <td></td> </tr> </tbody> </table>		Default	To make program change			DTMF receiver	1, 2, 3	1	(2)	3	Enable	x				Disable				
	Default	To make program change																				
DTMF receiver	1, 2, 3	1	(2)	3																		
Enable	x																					
Disable																						

TO SET	PROGRAM ADDRESS	STEPS REQUIRED TO CHANGE PROGRAM												
Off Premise Extension	32	<p data-bbox="531 360 802 389">SELECT MEMORY END</p> <p data-bbox="563 398 783 434">..... Disable / Enable</p> <table border="1" data-bbox="491 450 1307 546"> <thead> <tr> <th></th> <th>Default</th> <th>To make program change</th> </tr> </thead> <tbody> <tr> <td>Enable</td> <td></td> <td></td> </tr> <tr> <td>Disable</td> <td>X</td> <td></td> </tr> </tbody> </table>		Default	To make program change	Enable			Disable	X				
	Default	To make program change												
Enable														
Disable	X													
Off Hook Call Announcement (OHCA)	33	<p data-bbox="531 624 802 654">SELECT MEMORY END</p> <p data-bbox="563 663 783 698">..... Disable / Enable</p> <table border="1" data-bbox="491 723 1307 819"> <thead> <tr> <th></th> <th>Default</th> <th>To make program change</th> </tr> </thead> <tbody> <tr> <td>Enable</td> <td>X</td> <td></td> </tr> <tr> <td>Disable</td> <td></td> <td></td> </tr> </tbody> </table>		Default	To make program change	Enable	X		Disable					
	Default	To make program change												
Enable	X													
Disable														
System Working Report	34	<p data-bbox="531 902 802 931">SELECT MEMORY END</p> <p data-bbox="563 940 1046 976">..... Dump Start / Dump Stop / SWR Data Clear</p> <table border="1" data-bbox="491 1003 1307 1131"> <thead> <tr> <th></th> <th>Default</th> <th>To make program change</th> </tr> </thead> <tbody> <tr> <td>Dump Start</td> <td>X</td> <td></td> </tr> <tr> <td>Dump Stop</td> <td></td> <td></td> </tr> <tr> <td>SWR Data Clear</td> <td></td> <td></td> </tr> </tbody> </table>		Default	To make program change	Dump Start	X		Dump Stop			SWR Data Clear		
	Default	To make program change												
Dump Start	X													
Dump Stop														
SWR Data Clear														

PROGRAMMING TABLE (cont.)

TO SET	PROGRAM ADDRESS	STEPS REQUIRED TO CHANGE PROGRAM																																																																																																																																																																																					
CO Connection Assignment	40	<p style="text-align: center;"> NEXT SELECT MEMORY END </p> <p style="text-align: center;"> Connect / Not Connect until the desired CO number (01 through 12) appears </p> <table border="1" style="width: 100%; border-collapse: collapse; margin-top: 10px;"> <thead> <tr> <th rowspan="2"></th> <th>Default</th> <th colspan="12">To make program change</th> </tr> <tr> <th>all CO's</th> <th colspan="12">CO number</th> </tr> <tr> <th></th> <th></th> <th>01</th><th>02</th><th>03</th><th>04</th><th>05</th><th>06</th><th>07</th><th>08</th><th>09</th><th>10</th><th>11</th><th>12</th> </tr> </thead> <tbody> <tr> <td>Connect</td> <td style="text-align: center;">x</td> <td style="text-align: center;">x</td><td style="text-align: center;">x</td><td style="text-align: center;">y</td><td></td><td></td><td></td><td></td><td></td><td></td><td></td><td></td><td></td> </tr> <tr> <td>Not connect</td> <td></td> <td></td><td></td><td></td><td style="text-align: center;">x</td><td style="text-align: center;">x</td><td style="text-align: center;">x</td><td style="text-align: center;">x</td><td style="text-align: center;">x</td><td style="text-align: center;">x</td><td style="text-align: center;">x</td><td style="text-align: center;">x</td><td style="text-align: center;">x</td> </tr> </tbody> </table>		Default	To make program change												all CO's	CO number														01	02	03	04	05	06	07	08	09	10	11	12	Connect	x	x	x	y										Not connect					x	x	x	x	x	x	x	x	x																																																																																																																
	Default	To make program change																																																																																																																																																																																					
	all CO's	CO number																																																																																																																																																																																					
		01	02	03	04	05	06	07	08	09	10	11	12																																																																																																																																																																										
Connect	x	x	x	y																																																																																																																																																																																			
Not connect					x	x	x	x	x	x	x	x	x																																																																																																																																																																										
Dial Mode DTMF / Pulse / Call Blocking Selection	41	<p style="text-align: center;"> NEXT SELECT MEMORY END </p> <p style="text-align: center;"> DTMF Mode / Pulse Mode / Call Blocking Mode until the desired CO number (01 through 12) appears </p> <table border="1" style="width: 100%; border-collapse: collapse; margin-top: 10px;"> <thead> <tr> <th rowspan="2"></th> <th>Default</th> <th colspan="12">To make program change</th> </tr> <tr> <th>all CO's</th> <th colspan="12">CO number</th> </tr> <tr> <th></th> <th></th> <th>01</th><th>02</th><th>03</th><th>04</th><th>05</th><th>06</th><th>07</th><th>08</th><th>09</th><th>10</th><th>11</th><th>12</th> </tr> </thead> <tbody> <tr> <td>Tone (DTMF) Mode</td> <td></td> <td style="text-align: center;">x</td><td style="text-align: center;">x</td><td style="text-align: center;">x</td><td></td><td></td><td></td><td></td><td></td><td></td><td></td><td></td><td></td> </tr> <tr> <td>Pulse Mode</td> <td style="text-align: center;">x</td> <td></td><td></td><td></td><td></td><td></td><td></td><td></td><td></td><td></td><td></td><td></td><td></td> </tr> <tr> <td>Call Blocking Mode</td> <td></td> <td></td><td></td><td></td><td></td><td></td><td></td><td></td><td></td><td></td><td></td><td></td><td></td> </tr> </tbody> </table>		Default	To make program change												all CO's	CO number														01	02	03	04	05	06	07	08	09	10	11	12	Tone (DTMF) Mode		x	x	x										Pulse Mode	x													Call Blocking Mode																																																																																																															
	Default	To make program change																																																																																																																																																																																					
	all CO's	CO number																																																																																																																																																																																					
		01	02	03	04	05	06	07	08	09	10	11	12																																																																																																																																																																										
Tone (DTMF) Mode		x	x	x																																																																																																																																																																																			
Pulse Mode	x																																																																																																																																																																																						
Call Blocking Mode																																																																																																																																																																																							
Pulse Speed Selection	42	<p style="text-align: center;"> NEXT SELECT MEMORY END </p> <p style="text-align: center;"> Low Speed / High Speed until the desired CO number (01 through 12) appears </p> <table border="1" style="width: 100%; border-collapse: collapse; margin-top: 10px;"> <thead> <tr> <th rowspan="2"></th> <th>Default</th> <th colspan="12">To make program change</th> </tr> <tr> <th>all CO's</th> <th colspan="12">CO number</th> </tr> <tr> <th></th> <th></th> <th>01</th><th>02</th><th>03</th><th>04</th><th>05</th><th>06</th><th>07</th><th>08</th><th>09</th><th>10</th><th>11</th><th>12</th> </tr> </thead> <tbody> <tr> <td>Low Speed</td> <td style="text-align: center;">x</td> <td></td><td></td><td></td><td></td><td></td><td></td><td></td><td></td><td></td><td></td><td></td><td></td> </tr> <tr> <td>High Speed</td> <td></td> <td></td><td></td><td></td><td></td><td></td><td></td><td></td><td></td><td></td><td></td><td></td><td></td> </tr> </tbody> </table>		Default	To make program change												all CO's	CO number														01	02	03	04	05	06	07	08	09	10	11	12	Low Speed	x													High Speed																																																																																																																													
	Default	To make program change																																																																																																																																																																																					
	all CO's	CO number																																																																																																																																																																																					
		01	02	03	04	05	06	07	08	09	10	11	12																																																																																																																																																																										
Low Speed	x																																																																																																																																																																																						
High Speed																																																																																																																																																																																							
Host PBX Access Codes Assignment	43	<p style="text-align: center;"> NEXT A..D MEMORY END </p> <p style="text-align: center;"> up to 8 outside access codes each with a maximum of 2 digits until the desired CO number (01 through 12) appears </p> <table border="1" style="width: 100%; border-collapse: collapse; margin-top: 10px;"> <thead> <tr> <th>CO</th> <th colspan="12">Outside access codes of the host PBX</th> </tr> </thead> <tbody> <tr><td>01</td><td></td><td></td><td></td><td></td><td></td><td></td><td></td><td></td><td></td><td></td><td></td><td></td><td></td></tr> <tr><td>02</td><td></td><td></td><td></td><td></td><td></td><td></td><td></td><td></td><td></td><td></td><td></td><td></td><td></td></tr> <tr><td>03</td><td></td><td></td><td></td><td></td><td></td><td></td><td></td><td></td><td></td><td></td><td></td><td></td><td></td></tr> <tr><td>04</td><td></td><td></td><td></td><td></td><td></td><td></td><td></td><td></td><td></td><td></td><td></td><td></td><td></td></tr> <tr><td>05</td><td></td><td></td><td></td><td></td><td></td><td></td><td></td><td></td><td></td><td></td><td></td><td></td><td></td></tr> <tr><td>06</td><td></td><td></td><td></td><td></td><td></td><td></td><td></td><td></td><td></td><td></td><td></td><td></td><td></td></tr> <tr><td>07</td><td></td><td></td><td></td><td></td><td></td><td></td><td></td><td></td><td></td><td></td><td></td><td></td><td></td></tr> <tr><td>08</td><td></td><td></td><td></td><td></td><td></td><td></td><td></td><td></td><td></td><td></td><td></td><td></td><td></td></tr> <tr><td>09</td><td></td><td></td><td></td><td></td><td></td><td></td><td></td><td></td><td></td><td></td><td></td><td></td><td></td></tr> <tr><td>10</td><td></td><td></td><td></td><td></td><td></td><td></td><td></td><td></td><td></td><td></td><td></td><td></td><td></td></tr> <tr><td>11</td><td></td><td></td><td></td><td></td><td></td><td></td><td></td><td></td><td></td><td></td><td></td><td></td><td></td></tr> <tr><td>12</td><td></td><td></td><td></td><td></td><td></td><td></td><td></td><td></td><td></td><td></td><td></td><td></td><td></td></tr> </tbody> </table>	CO	Outside access codes of the host PBX												01														02														03														04														05														06														07														08														09														10														11														12													
CO	Outside access codes of the host PBX																																																																																																																																																																																						
01																																																																																																																																																																																							
02																																																																																																																																																																																							
03																																																																																																																																																																																							
04																																																																																																																																																																																							
05																																																																																																																																																																																							
06																																																																																																																																																																																							
07																																																																																																																																																																																							
08																																																																																																																																																																																							
09																																																																																																																																																																																							
10																																																																																																																																																																																							
11																																																																																																																																																																																							
12																																																																																																																																																																																							

771-8998

TO SET	PROGRAM ADDRESS	STEPS REQUIRED TO CHANGE PROGRAM																																																																																																																																																																																																																																																																																												
Trunk Group Assignment	44	<div style="text-align: center; margin-bottom: 10px;"> NEXT A MEMORY END </div> <p style="text-align: center; margin-left: 40px;"> dial the trunk group number (1 through 8) until the desired CO number (01 through 12) appears </p> <table border="1" style="width: 100%; border-collapse: collapse; margin-bottom: 10px;"> <thead> <tr> <th rowspan="2"></th> <th colspan="12" style="text-align: center;">Default</th> </tr> <tr> <th colspan="12" style="text-align: center;">CO number</th> </tr> <tr> <th></th> <th>01</th><th>02</th><th>03</th><th>04</th><th>05</th><th>06</th><th>07</th><th>08</th><th>09</th><th>10</th><th>11</th><th>12</th> </tr> </thead> <tbody> <tr><td>Trunk group 1</td><td></td><td></td><td></td><td></td><td></td><td></td><td></td><td></td><td></td><td></td><td></td><td></td></tr> <tr><td>Trunk group 2</td><td></td><td></td><td></td><td></td><td></td><td></td><td></td><td></td><td></td><td></td><td></td><td></td></tr> <tr><td>Trunk group 3</td><td></td><td></td><td></td><td></td><td></td><td></td><td></td><td></td><td></td><td></td><td></td><td></td></tr> <tr><td>Trunk group 4</td><td></td><td></td><td></td><td></td><td></td><td></td><td></td><td></td><td></td><td></td><td></td><td></td></tr> <tr><td>Trunk group 5</td><td></td><td></td><td></td><td></td><td></td><td></td><td></td><td></td><td></td><td></td><td></td><td></td></tr> <tr><td>Trunk group 6</td><td></td><td></td><td></td><td></td><td></td><td></td><td></td><td></td><td></td><td></td><td></td><td></td></tr> <tr><td>Trunk group 7</td><td></td><td></td><td></td><td></td><td></td><td></td><td></td><td></td><td></td><td></td><td></td><td></td></tr> <tr><td>Trunk group 8</td><td></td><td></td><td></td><td></td><td></td><td></td><td></td><td></td><td></td><td></td><td style="text-align: center;">x</td><td style="text-align: center;">x</td></tr> </tbody> </table> <table border="1" style="width: 100%; border-collapse: collapse;"> <thead> <tr> <th rowspan="2"></th> <th colspan="12" style="text-align: center;">To make program change</th> </tr> <tr> <th colspan="12" style="text-align: center;">CO number</th> </tr> <tr> <th></th> <th>01</th><th>02</th><th>03</th><th>04</th><th>05</th><th>06</th><th>07</th><th>08</th><th>09</th><th>10</th><th>11</th><th>12</th> </tr> </thead> <tbody> <tr><td>Trunk group 1</td><td></td><td></td><td></td><td></td><td></td><td></td><td></td><td></td><td></td><td></td><td></td><td></td></tr> <tr><td>Trunk group 2</td><td></td><td></td><td></td><td></td><td></td><td></td><td></td><td></td><td></td><td></td><td></td><td></td></tr> <tr><td>Trunk group 3</td><td></td><td></td><td></td><td></td><td></td><td></td><td></td><td></td><td></td><td></td><td></td><td></td></tr> <tr><td>Trunk group 4</td><td></td><td></td><td></td><td></td><td></td><td></td><td></td><td></td><td></td><td></td><td></td><td></td></tr> <tr><td>Trunk group 5</td><td></td><td></td><td></td><td></td><td></td><td></td><td></td><td></td><td></td><td></td><td></td><td></td></tr> <tr><td>Trunk group 6</td><td></td><td></td><td></td><td></td><td></td><td></td><td></td><td></td><td></td><td></td><td></td><td></td></tr> <tr><td>Trunk group 7</td><td></td><td></td><td></td><td></td><td></td><td></td><td></td><td></td><td></td><td></td><td></td><td></td></tr> <tr><td>Trunk group 8</td><td></td><td></td><td></td><td></td><td></td><td></td><td></td><td></td><td></td><td></td><td></td><td></td></tr> </tbody> </table>		Default												CO number													01	02	03	04	05	06	07	08	09	10	11	12	Trunk group 1													Trunk group 2													Trunk group 3													Trunk group 4													Trunk group 5													Trunk group 6													Trunk group 7													Trunk group 8											x	x		To make program change												CO number													01	02	03	04	05	06	07	08	09	10	11	12	Trunk group 1													Trunk group 2													Trunk group 3													Trunk group 4													Trunk group 5													Trunk group 6													Trunk group 7													Trunk group 8												
	Default																																																																																																																																																																																																																																																																																													
	CO number																																																																																																																																																																																																																																																																																													
	01	02	03	04	05	06	07	08	09	10	11	12																																																																																																																																																																																																																																																																																		
Trunk group 1																																																																																																																																																																																																																																																																																														
Trunk group 2																																																																																																																																																																																																																																																																																														
Trunk group 3																																																																																																																																																																																																																																																																																														
Trunk group 4																																																																																																																																																																																																																																																																																														
Trunk group 5																																																																																																																																																																																																																																																																																														
Trunk group 6																																																																																																																																																																																																																																																																																														
Trunk group 7																																																																																																																																																																																																																																																																																														
Trunk group 8											x	x																																																																																																																																																																																																																																																																																		
	To make program change																																																																																																																																																																																																																																																																																													
	CO number																																																																																																																																																																																																																																																																																													
	01	02	03	04	05	06	07	08	09	10	11	12																																																																																																																																																																																																																																																																																		
Trunk group 1																																																																																																																																																																																																																																																																																														
Trunk group 2																																																																																																																																																																																																																																																																																														
Trunk group 3																																																																																																																																																																																																																																																																																														
Trunk group 4																																																																																																																																																																																																																																																																																														
Trunk group 5																																																																																																																																																																																																																																																																																														
Trunk group 6																																																																																																																																																																																																																																																																																														
Trunk group 7																																																																																																																																																																																																																																																																																														
Trunk group 8																																																																																																																																																																																																																																																																																														

PROGRAMMING TABLE (cont.)

TO SET	PROGRAM ADDRESS	STEPS REQUIRED TO CHANGE PROGRAM																																																																																																																																																																																																																																																																																																																																																																																																																																																																																																																																													
Flexible Outward Dialing Assignment Day Mode	45	<div style="display: flex; justify-content: center; align-items: center; gap: 10px;"> <div style="text-align: center;"> <p>other CO number</p> <p>other jack number</p> <p>NEXT SELECT MEMORY END</p> <p>..... Enable / Disable</p> <p>..... until the desired jack number (01 through 32) appears</p> <p>..... until the desired CO number (01 through 12) appears</p> </div> </div>																																																																																																																																																																																																																																																																																																																																																																																																																																																																																																																																													
		<table border="1" style="width: 100%; border-collapse: collapse; text-align: center;"> <thead> <tr> <th colspan="2" rowspan="2"></th> <th rowspan="2">Default all jack numbers</th> <th colspan="16">To make program change</th> </tr> <tr> <th colspan="16">Jack number</th> </tr> <tr> <th>CO</th> <th>State</th> <th></th> <th>01</th><th>02</th><th>03</th><th>04</th><th>05</th><th>06</th><th>07</th><th>08</th><th>09</th><th>10</th><th>11</th><th>12</th><th>13</th><th>14</th><th>15</th><th>16</th> </tr> </thead> <tbody> <tr><td>CO 1</td><td>Enable</td><td>x</td><td>✓</td><td></td><td></td><td></td><td></td><td></td><td></td><td></td><td></td><td></td><td></td><td></td><td></td><td></td><td></td><td></td></tr> <tr><td>CO 1</td><td>Disable</td><td></td><td></td><td>✗</td><td></td><td></td><td></td><td></td><td></td><td></td><td></td><td></td><td></td><td></td><td></td><td></td><td></td><td></td></tr> <tr><td>CO 2</td><td>Enable</td><td>x</td><td>✗</td><td></td><td></td><td></td><td></td><td></td><td></td><td></td><td></td><td></td><td></td><td></td><td></td><td></td><td></td><td></td></tr> <tr><td>CO 2</td><td>Disable</td><td></td><td></td><td>✗</td><td></td><td></td><td></td><td></td><td></td><td></td><td></td><td></td><td></td><td></td><td></td><td></td><td></td><td></td></tr> <tr><td>CO 3</td><td>Enable</td><td>x</td><td>✓</td><td></td><td></td><td></td><td></td><td></td><td></td><td></td><td></td><td></td><td></td><td></td><td></td><td></td><td></td><td></td></tr> <tr><td>CO 3</td><td>Disable</td><td></td><td></td><td>✗</td><td></td><td></td><td></td><td></td><td></td><td></td><td></td><td></td><td></td><td></td><td></td><td></td><td></td><td></td></tr> <tr><td>CO 4</td><td>Enable</td><td>x</td><td>✓</td><td></td><td></td><td></td><td></td><td></td><td></td><td></td><td></td><td></td><td></td><td></td><td></td><td></td><td></td><td></td></tr> <tr><td>CO 4</td><td>Disable</td><td></td><td></td><td>✗</td><td></td><td></td><td></td><td></td><td></td><td></td><td></td><td></td><td></td><td></td><td></td><td></td><td></td><td></td></tr> <tr><td>CO 5</td><td>Enable</td><td>x</td><td>✓</td><td></td><td></td><td></td><td></td><td></td><td></td><td></td><td></td><td></td><td></td><td></td><td></td><td></td><td></td><td></td></tr> <tr><td>CO 5</td><td>Disable</td><td></td><td></td><td>✗</td><td></td><td></td><td></td><td></td><td></td><td></td><td></td><td></td><td></td><td></td><td></td><td></td><td></td><td></td></tr> <tr><td>CO 6</td><td>Enable</td><td>x</td><td>✓</td><td></td><td></td><td></td><td></td><td></td><td></td><td></td><td></td><td></td><td></td><td></td><td></td><td></td><td></td><td></td></tr> <tr><td>CO 6</td><td>Disable</td><td></td><td></td><td>✗</td><td></td><td></td><td></td><td></td><td></td><td></td><td></td><td></td><td></td><td></td><td></td><td></td><td></td><td></td></tr> <tr><td>CO 7</td><td>Enable</td><td>x</td><td>✓</td><td></td><td></td><td></td><td></td><td></td><td></td><td></td><td></td><td></td><td></td><td></td><td></td><td></td><td></td><td></td></tr> <tr><td>CO 7</td><td>Disable</td><td></td><td></td><td>✗</td><td></td><td></td><td></td><td></td><td></td><td></td><td></td><td></td><td></td><td></td><td></td><td></td><td></td><td></td></tr> <tr><td>CO 8</td><td>Enable</td><td>x</td><td>✓</td><td></td><td></td><td></td><td></td><td></td><td></td><td></td><td></td><td></td><td></td><td></td><td></td><td></td><td></td><td></td></tr> <tr><td>CO 8</td><td>Disable</td><td></td><td></td><td>✗</td><td></td><td></td><td></td><td></td><td></td><td></td><td></td><td></td><td></td><td></td><td></td><td></td><td></td><td></td></tr> <tr><td>CO 9</td><td>Enable</td><td>x</td><td>✓</td><td></td><td></td><td></td><td></td><td></td><td></td><td></td><td></td><td></td><td></td><td></td><td></td><td></td><td></td><td></td></tr> <tr><td>CO 9</td><td>Disable</td><td></td><td></td><td>✗</td><td></td><td></td><td></td><td></td><td></td><td></td><td></td><td></td><td></td><td></td><td></td><td></td><td></td><td></td></tr> <tr><td>CO 10</td><td>Enable</td><td>x</td><td>✓</td><td></td><td></td><td></td><td></td><td></td><td></td><td></td><td></td><td></td><td></td><td></td><td></td><td></td><td></td><td></td></tr> <tr><td>CO 10</td><td>Disable</td><td></td><td></td><td>✗</td><td></td><td></td><td></td><td></td><td></td><td></td><td></td><td></td><td></td><td></td><td></td><td></td><td></td><td></td></tr> <tr><td>CO 11</td><td>Enable</td><td>x</td><td>✓</td><td></td><td></td><td></td><td></td><td></td><td></td><td></td><td></td><td></td><td></td><td></td><td></td><td></td><td></td><td></td></tr> <tr><td>CO 11</td><td>Disable</td><td></td><td></td><td>✗</td><td></td><td></td><td></td><td></td><td></td><td></td><td></td><td></td><td></td><td></td><td></td><td></td><td></td><td></td></tr> <tr><td>CO 12</td><td>Enable</td><td>x</td><td>✗</td><td>✗</td><td></td><td></td><td></td><td></td><td></td><td></td><td></td><td></td><td></td><td></td><td></td><td></td><td></td><td></td></tr> <tr><td>CO 12</td><td>Disable</td><td></td><td></td><td></td><td></td><td></td><td></td><td></td><td></td><td></td><td></td><td></td><td></td><td></td><td></td><td></td><td></td><td></td></tr> </tbody> </table>																		Default all jack numbers	To make program change																Jack number																CO	State		01	02	03	04	05	06	07	08	09	10	11	12	13	14	15	16	CO 1	Enable	x	✓																CO 1	Disable			✗															CO 2	Enable	x	✗																CO 2	Disable			✗															CO 3	Enable	x	✓																CO 3	Disable			✗															CO 4	Enable	x	✓																CO 4	Disable			✗															CO 5	Enable	x	✓																CO 5	Disable			✗															CO 6	Enable	x	✓																CO 6	Disable			✗															CO 7	Enable	x	✓																CO 7	Disable			✗															CO 8	Enable	x	✓																CO 8	Disable			✗															CO 9	Enable	x	✓																CO 9	Disable			✗															CO 10	Enable	x	✓																CO 10	Disable			✗															CO 11	Enable	x	✓																CO 11	Disable			✗															CO 12	Enable	x	✗	✗															CO 12	Disable																	
		Default all jack numbers	To make program change																																																																																																																																																																																																																																																																																																																																																																																																																																																																																																																																												
			Jack number																																																																																																																																																																																																																																																																																																																																																																																																																																																																																																																																												
CO	State		01	02	03	04	05	06	07	08	09	10	11	12	13	14	15	16																																																																																																																																																																																																																																																																																																																																																																																																																																																																																																																													
CO 1	Enable	x	✓																																																																																																																																																																																																																																																																																																																																																																																																																																																																																																																																												
CO 1	Disable			✗																																																																																																																																																																																																																																																																																																																																																																																																																																																																																																																																											
CO 2	Enable	x	✗																																																																																																																																																																																																																																																																																																																																																																																																																																																																																																																																												
CO 2	Disable			✗																																																																																																																																																																																																																																																																																																																																																																																																																																																																																																																																											
CO 3	Enable	x	✓																																																																																																																																																																																																																																																																																																																																																																																																																																																																																																																																												
CO 3	Disable			✗																																																																																																																																																																																																																																																																																																																																																																																																																																																																																																																																											
CO 4	Enable	x	✓																																																																																																																																																																																																																																																																																																																																																																																																																																																																																																																																												
CO 4	Disable			✗																																																																																																																																																																																																																																																																																																																																																																																																																																																																																																																																											
CO 5	Enable	x	✓																																																																																																																																																																																																																																																																																																																																																																																																																																																																																																																																												
CO 5	Disable			✗																																																																																																																																																																																																																																																																																																																																																																																																																																																																																																																																											
CO 6	Enable	x	✓																																																																																																																																																																																																																																																																																																																																																																																																																																																																																																																																												
CO 6	Disable			✗																																																																																																																																																																																																																																																																																																																																																																																																																																																																																																																																											
CO 7	Enable	x	✓																																																																																																																																																																																																																																																																																																																																																																																																																																																																																																																																												
CO 7	Disable			✗																																																																																																																																																																																																																																																																																																																																																																																																																																																																																																																																											
CO 8	Enable	x	✓																																																																																																																																																																																																																																																																																																																																																																																																																																																																																																																																												
CO 8	Disable			✗																																																																																																																																																																																																																																																																																																																																																																																																																																																																																																																																											
CO 9	Enable	x	✓																																																																																																																																																																																																																																																																																																																																																																																																																																																																																																																																												
CO 9	Disable			✗																																																																																																																																																																																																																																																																																																																																																																																																																																																																																																																																											
CO 10	Enable	x	✓																																																																																																																																																																																																																																																																																																																																																																																																																																																																																																																																												
CO 10	Disable			✗																																																																																																																																																																																																																																																																																																																																																																																																																																																																																																																																											
CO 11	Enable	x	✓																																																																																																																																																																																																																																																																																																																																																																																																																																																																																																																																												
CO 11	Disable			✗																																																																																																																																																																																																																																																																																																																																																																																																																																																																																																																																											
CO 12	Enable	x	✗	✗																																																																																																																																																																																																																																																																																																																																																																																																																																																																																																																																											
CO 12	Disable																																																																																																																																																																																																																																																																																																																																																																																																																																																																																																																																														
		<table border="1" style="width: 100%; border-collapse: collapse; text-align: center;"> <thead> <tr> <th colspan="2" rowspan="2"></th> <th rowspan="2">Default</th> <th colspan="16">To make program change</th> </tr> <tr> <th colspan="16">Jack number</th> </tr> <tr> <th>CO</th> <th>State</th> <th></th> <th>17</th><th>18</th><th>19</th><th>20</th><th>21</th><th>22</th><th>23</th><th>24</th><th>25</th><th>26</th><th>27</th><th>28</th><th>29</th><th>30</th><th>31</th><th>32</th> </tr> </thead> <tbody> <tr><td>CO 1</td><td>Enable</td><td></td><td></td><td></td><td></td><td></td><td></td><td></td><td></td><td></td><td></td><td></td><td></td><td></td><td></td><td></td><td></td><td></td></tr> <tr><td>CO 1</td><td>Disable</td><td></td><td></td><td></td><td></td><td></td><td></td><td></td><td></td><td></td><td></td><td></td><td></td><td></td><td></td><td></td><td></td><td></td></tr> <tr><td>CO 2</td><td>Enable</td><td></td><td></td><td></td><td></td><td></td><td></td><td></td><td></td><td></td><td></td><td></td><td></td><td></td><td></td><td></td><td></td><td></td></tr> <tr><td>CO 2</td><td>Disable</td><td></td><td></td><td></td><td></td><td></td><td></td><td></td><td></td><td></td><td></td><td></td><td></td><td></td><td></td><td></td><td></td><td></td></tr> <tr><td>CO 3</td><td>Enable</td><td></td><td></td><td></td><td></td><td></td><td></td><td></td><td></td><td></td><td></td><td></td><td></td><td></td><td></td><td></td><td></td><td></td></tr> <tr><td>CO 3</td><td>Disable</td><td></td><td></td><td></td><td></td><td></td><td></td><td></td><td></td><td></td><td></td><td></td><td></td><td></td><td></td><td></td><td></td><td></td></tr> <tr><td>CO 4</td><td>Enable</td><td></td><td></td><td></td><td></td><td></td><td></td><td></td><td></td><td></td><td></td><td></td><td></td><td></td><td></td><td></td><td></td><td></td></tr> <tr><td>CO 4</td><td>Disable</td><td></td><td></td><td></td><td></td><td></td><td></td><td></td><td></td><td></td><td></td><td></td><td></td><td></td><td></td><td></td><td></td><td></td></tr> <tr><td>CO 5</td><td>Enable</td><td></td><td></td><td></td><td></td><td></td><td></td><td></td><td></td><td></td><td></td><td></td><td></td><td></td><td></td><td></td><td></td><td></td></tr> <tr><td>CO 5</td><td>Disable</td><td></td><td></td><td></td><td></td><td></td><td></td><td></td><td></td><td></td><td></td><td></td><td></td><td></td><td></td><td></td><td></td><td></td></tr> <tr><td>CO 6</td><td>Enable</td><td></td><td></td><td></td><td></td><td></td><td></td><td></td><td></td><td></td><td></td><td></td><td></td><td></td><td></td><td></td><td></td><td></td></tr> <tr><td>CO 6</td><td>Disable</td><td></td><td></td><td></td><td></td><td></td><td></td><td></td><td></td><td></td><td></td><td></td><td></td><td></td><td></td><td></td><td></td><td></td></tr> <tr><td>CO 7</td><td>Enable</td><td></td><td></td><td></td><td></td><td></td><td></td><td></td><td></td><td></td><td></td><td></td><td></td><td></td><td></td><td></td><td></td><td></td></tr> <tr><td>CO 7</td><td>Disable</td><td></td><td></td><td></td><td></td><td></td><td></td><td></td><td></td><td></td><td></td><td></td><td></td><td></td><td></td><td></td><td></td><td></td></tr> <tr><td>CO 8</td><td>Enable</td><td></td><td></td><td></td><td></td><td></td><td></td><td></td><td></td><td></td><td></td><td></td><td></td><td></td><td></td><td></td><td></td><td></td></tr> <tr><td>CO 8</td><td>Disable</td><td></td><td></td><td></td><td></td><td></td><td></td><td></td><td></td><td></td><td></td><td></td><td></td><td></td><td></td><td></td><td></td><td></td></tr> <tr><td>CO 9</td><td>Enable</td><td></td><td></td><td></td><td></td><td></td><td></td><td></td><td></td><td></td><td></td><td></td><td></td><td></td><td></td><td></td><td></td><td></td></tr> <tr><td>CO 9</td><td>Disable</td><td></td><td></td><td></td><td></td><td></td><td></td><td></td><td></td><td></td><td></td><td></td><td></td><td></td><td></td><td></td><td></td><td></td></tr> <tr><td>CO 10</td><td>Enable</td><td></td><td></td><td></td><td></td><td></td><td></td><td></td><td></td><td></td><td></td><td></td><td></td><td></td><td></td><td></td><td></td><td></td></tr> <tr><td>CO 10</td><td>Disable</td><td></td><td></td><td></td><td></td><td></td><td></td><td></td><td></td><td></td><td></td><td></td><td></td><td></td><td></td><td></td><td></td><td></td></tr> <tr><td>CO 11</td><td>Enable</td><td></td><td></td><td></td><td></td><td></td><td></td><td></td><td></td><td></td><td></td><td></td><td></td><td></td><td></td><td></td><td></td><td></td></tr> <tr><td>CO 11</td><td>Disable</td><td></td><td></td><td></td><td></td><td></td><td></td><td></td><td></td><td></td><td></td><td></td><td></td><td></td><td></td><td></td><td></td><td></td></tr> <tr><td>CO 12</td><td>Enable</td><td></td><td></td><td></td><td></td><td></td><td></td><td></td><td></td><td></td><td></td><td></td><td></td><td></td><td></td><td></td><td></td><td></td></tr> <tr><td>CO 12</td><td>Disable</td><td></td><td></td><td></td><td></td><td></td><td></td><td></td><td></td><td></td><td></td><td></td><td></td><td></td><td></td><td></td><td></td><td></td></tr> </tbody> </table>																		Default	To make program change																Jack number																CO	State		17	18	19	20	21	22	23	24	25	26	27	28	29	30	31	32	CO 1	Enable																		CO 1	Disable																		CO 2	Enable																		CO 2	Disable																		CO 3	Enable																		CO 3	Disable																		CO 4	Enable																		CO 4	Disable																		CO 5	Enable																		CO 5	Disable																		CO 6	Enable																		CO 6	Disable																		CO 7	Enable																		CO 7	Disable																		CO 8	Enable																		CO 8	Disable																		CO 9	Enable																		CO 9	Disable																		CO 10	Enable																		CO 10	Disable																		CO 11	Enable																		CO 11	Disable																		CO 12	Enable																		CO 12	Disable																	
		Default	To make program change																																																																																																																																																																																																																																																																																																																																																																																																																																																																																																																																												
			Jack number																																																																																																																																																																																																																																																																																																																																																																																																																																																																																																																																												
CO	State		17	18	19	20	21	22	23	24	25	26	27	28	29	30	31	32																																																																																																																																																																																																																																																																																																																																																																																																																																																																																																																													
CO 1	Enable																																																																																																																																																																																																																																																																																																																																																																																																																																																																																																																																														
CO 1	Disable																																																																																																																																																																																																																																																																																																																																																																																																																																																																																																																																														
CO 2	Enable																																																																																																																																																																																																																																																																																																																																																																																																																																																																																																																																														
CO 2	Disable																																																																																																																																																																																																																																																																																																																																																																																																																																																																																																																																														
CO 3	Enable																																																																																																																																																																																																																																																																																																																																																																																																																																																																																																																																														
CO 3	Disable																																																																																																																																																																																																																																																																																																																																																																																																																																																																																																																																														
CO 4	Enable																																																																																																																																																																																																																																																																																																																																																																																																																																																																																																																																														
CO 4	Disable																																																																																																																																																																																																																																																																																																																																																																																																																																																																																																																																														
CO 5	Enable																																																																																																																																																																																																																																																																																																																																																																																																																																																																																																																																														
CO 5	Disable																																																																																																																																																																																																																																																																																																																																																																																																																																																																																																																																														
CO 6	Enable																																																																																																																																																																																																																																																																																																																																																																																																																																																																																																																																														
CO 6	Disable																																																																																																																																																																																																																																																																																																																																																																																																																																																																																																																																														
CO 7	Enable																																																																																																																																																																																																																																																																																																																																																																																																																																																																																																																																														
CO 7	Disable																																																																																																																																																																																																																																																																																																																																																																																																																																																																																																																																														
CO 8	Enable																																																																																																																																																																																																																																																																																																																																																																																																																																																																																																																																														
CO 8	Disable																																																																																																																																																																																																																																																																																																																																																																																																																																																																																																																																														
CO 9	Enable																																																																																																																																																																																																																																																																																																																																																																																																																																																																																																																																														
CO 9	Disable																																																																																																																																																																																																																																																																																																																																																																																																																																																																																																																																														
CO 10	Enable																																																																																																																																																																																																																																																																																																																																																																																																																																																																																																																																														
CO 10	Disable																																																																																																																																																																																																																																																																																																																																																																																																																																																																																																																																														
CO 11	Enable																																																																																																																																																																																																																																																																																																																																																																																																																																																																																																																																														
CO 11	Disable																																																																																																																																																																																																																																																																																																																																																																																																																																																																																																																																														
CO 12	Enable																																																																																																																																																																																																																																																																																																																																																																																																																																																																																																																																														
CO 12	Disable																																																																																																																																																																																																																																																																																																																																																																																																																																																																																																																																														

TO SET

PROGRAM ADDRESS

STEPS REQUIRED TO CHANGE PROGRAM

Flexible Outward Dialing Assignment (cont.)

46

Night Mode

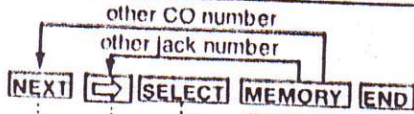

Enable / Disable until the desired jack number (01 through 32) appears until the desired CO number (01 through 12) appears

		Default all jack numbers	To make program change															
			Jack number															
			01	02	03	04	05	06	07	08	09	10	11	12	13	14	15	16
CO 1	Enable	.																
	Disable	.																
CO 2	Enable	.																
	Disable	.																
CO 3	Enable	.																
	Disable	.																
CO 4	Enable	.																
	Disable	.																
CO 5	Enable	.																
	Disable	.																
CO 6	Enable	.																
	Disable	.																
CO 7	Enable	.																
	Disable	.																
CO 8	Enable	.																
	Disable	.																
CO 9	Enable	.																
	Disable	.																
CO 10	Enable	.																
	Disable	.																
CO 11	Enable	.																
	Disable	.																
CO 12	Enable	.																
	Disable	.																

na Est.

Insufficient

Ans

Est 32

		To make program change															
		Jack number															
		17	18	19	20	21	22	23	24	25	26	27	28	29	30	31	32
CO 1	Enable																
	Disable																
CO 2	Enable																
	Disable																
CO 3	Enable																
	Disable																
CO 4	Enable																
	Disable																
CO 5	Enable																
	Disable																
CO 6	Enable																
	Disable																
CO 7	Enable																
	Disable																
CO 8	Enable																
	Disable																
CO 9	Enable																
	Disable																
CO 10	Enable																
	Disable																
CO 11	Enable																
	Disable																
CO 12	Enable																
	Disable																

PROGRAMMING TABLE (cont.)

TO SET	PROGRAM ADDRESS	STEPS REQUIRED TO CHANGE PROGRAM																																																																																																																																																																																																																																																																																																																																																																																																																																																																																																																																																																																																																																																																																																																																																																																																																																																																																																																																																																																																									
Flexible Ringing Assignment Day Mode	47	<div style="display: flex; justify-content: center; align-items: center; gap: 10px;"> <div style="text-align: center;"> other CO number ↓ other jack number ↓ NEXT ← SELECT MEMORY END </div> <div style="text-align: center;"> Enable / Disable until the desired jack number (01 through 32) appears until the desired CO number (01 through 12) appears </div> </div>																																																																																																																																																																																																																																																																																																																																																																																																																																																																																																																																																																																																																																																																																																																																																																																																																																																																																																																																																																																																									
		<table border="1" style="width: 100%; border-collapse: collapse;"> <thead> <tr> <th colspan="2" rowspan="2"></th> <th rowspan="2">Default all jack numbers</th> <th colspan="16">To make program change</th> </tr> <tr> <th colspan="16">Jack number</th> </tr> <tr> <th></th> <th></th> <th></th> <th>01</th><th>02</th><th>03</th><th>04</th><th>05</th><th>06</th><th>07</th><th>08</th><th>09</th><th>10</th><th>11</th><th>12</th><th>13</th><th>14</th><th>15</th><th>16</th> </tr> </thead> <tbody> <tr><td rowspan="2">CO 1</td><td>Enable</td><td style="text-align: center;">x</td><td></td><td></td><td></td><td></td><td></td><td></td><td></td><td></td><td></td><td></td><td></td><td></td><td></td><td></td><td></td><td></td></tr> <tr><td>Disable</td><td></td><td></td><td></td><td></td><td></td><td></td><td></td><td></td><td></td><td></td><td></td><td></td><td></td><td></td><td></td><td></td><td></td></tr> <tr><td rowspan="2">CO 2</td><td>Enable</td><td style="text-align: center;">x</td><td></td><td></td><td></td><td></td><td></td><td></td><td></td><td></td><td></td><td></td><td></td><td></td><td></td><td></td><td></td><td></td></tr> <tr><td>Disable</td><td></td><td></td><td></td><td></td><td></td><td></td><td></td><td></td><td></td><td></td><td></td><td></td><td></td><td></td><td></td><td></td><td></td></tr> <tr><td rowspan="2">CO 3</td><td>Enable</td><td style="text-align: center;">x</td><td></td><td></td><td></td><td></td><td></td><td></td><td></td><td></td><td></td><td></td><td></td><td></td><td></td><td></td><td></td><td></td></tr> <tr><td>Disable</td><td></td><td></td><td></td><td></td><td></td><td></td><td></td><td></td><td></td><td></td><td></td><td></td><td></td><td></td><td></td><td></td><td></td></tr> <tr><td rowspan="2">CO 4</td><td>Enable</td><td style="text-align: center;">x</td><td></td><td></td><td></td><td></td><td></td><td></td><td></td><td></td><td></td><td></td><td></td><td></td><td></td><td></td><td></td><td></td></tr> <tr><td>Disable</td><td></td><td></td><td></td><td></td><td></td><td></td><td></td><td></td><td></td><td></td><td></td><td></td><td></td><td></td><td></td><td></td><td></td></tr> <tr><td rowspan="2">CO 5</td><td>Enable</td><td style="text-align: center;">x</td><td></td><td></td><td></td><td></td><td></td><td></td><td></td><td></td><td></td><td></td><td></td><td></td><td></td><td></td><td></td><td></td></tr> <tr><td>Disable</td><td></td><td></td><td></td><td></td><td></td><td></td><td></td><td></td><td></td><td></td><td></td><td></td><td></td><td></td><td></td><td></td><td></td></tr> <tr><td rowspan="2">CO 6</td><td>Enable</td><td style="text-align: center;">x</td><td></td><td></td><td></td><td></td><td></td><td></td><td></td><td></td><td></td><td></td><td></td><td></td><td></td><td></td><td></td><td></td></tr> <tr><td>Disable</td><td></td><td></td><td></td><td></td><td></td><td></td><td></td><td></td><td></td><td></td><td></td><td></td><td></td><td></td><td></td><td></td><td></td></tr> <tr><td rowspan="2">CO 7</td><td>Enable</td><td style="text-align: center;">x</td><td></td><td></td><td></td><td></td><td></td><td></td><td></td><td></td><td></td><td></td><td></td><td></td><td></td><td></td><td></td><td></td></tr> <tr><td>Disable</td><td></td><td></td><td></td><td></td><td></td><td></td><td></td><td></td><td></td><td></td><td></td><td></td><td></td><td></td><td></td><td></td><td></td></tr> <tr><td rowspan="2">CO 8</td><td>Enable</td><td style="text-align: center;">x</td><td></td><td></td><td></td><td></td><td></td><td></td><td></td><td></td><td></td><td></td><td></td><td></td><td></td><td></td><td></td><td></td></tr> <tr><td>Disable</td><td></td><td></td><td></td><td></td><td></td><td></td><td></td><td></td><td></td><td></td><td></td><td></td><td></td><td></td><td></td><td></td><td></td></tr> <tr><td rowspan="2">CO 9</td><td>Enable</td><td style="text-align: center;">x</td><td></td><td></td><td></td><td></td><td></td><td></td><td></td><td></td><td></td><td></td><td></td><td></td><td></td><td></td><td></td><td></td></tr> <tr><td>Disable</td><td></td><td></td><td></td><td></td><td></td><td></td><td></td><td></td><td></td><td></td><td></td><td></td><td></td><td></td><td></td><td></td><td></td></tr> <tr><td rowspan="2">CO 10</td><td>Enable</td><td style="text-align: center;">x</td><td></td><td></td><td></td><td></td><td></td><td></td><td></td><td></td><td></td><td></td><td></td><td></td><td></td><td></td><td></td><td></td></tr> <tr><td>Disable</td><td></td><td></td><td></td><td></td><td></td><td></td><td></td><td></td><td></td><td></td><td></td><td></td><td></td><td></td><td></td><td></td><td></td></tr> <tr><td rowspan="2">CO 11</td><td>Enable</td><td style="text-align: center;">x</td><td></td><td></td><td></td><td></td><td></td><td></td><td></td><td></td><td></td><td></td><td></td><td></td><td></td><td></td><td></td><td></td></tr> <tr><td>Disable</td><td></td><td></td><td></td><td></td><td></td><td></td><td></td><td></td><td></td><td></td><td></td><td></td><td></td><td></td><td></td><td></td><td></td></tr> <tr><td rowspan="2">CO 12</td><td>Enable</td><td style="text-align: center;">x</td><td></td><td></td><td></td><td></td><td></td><td></td><td></td><td></td><td></td><td></td><td></td><td></td><td></td><td></td><td></td><td></td></tr> <tr><td>Disable</td><td></td><td></td><td></td><td></td><td></td><td></td><td></td><td></td><td></td><td></td><td></td><td></td><td></td><td></td><td></td><td></td><td></td></tr> </tbody> </table> <table border="1" style="width: 100%; border-collapse: collapse;"> <thead> <tr> <th colspan="2" rowspan="2"></th> <th colspan="16">To make program change</th> </tr> <tr> <th colspan="16">Jack number</th> </tr> <tr> <th></th> <th></th> <th>17</th><th>18</th><th>19</th><th>20</th><th>21</th><th>22</th><th>23</th><th>24</th><th>25</th><th>26</th><th>27</th><th>28</th><th>29</th><th>30</th><th>31</th><th>32</th> </tr> </thead> <tbody> <tr><td rowspan="2">CO 1</td><td>Enable</td><td></td><td></td><td></td><td></td><td></td><td></td><td></td><td></td><td></td><td></td><td></td><td></td><td></td><td></td><td></td><td></td></tr> <tr><td>Disable</td><td></td><td></td><td></td><td></td><td></td><td></td><td></td><td></td><td></td><td></td><td></td><td></td><td></td><td></td><td></td><td></td></tr> <tr><td rowspan="2">CO 2</td><td>Enable</td><td></td><td></td><td></td><td></td><td></td><td></td><td></td><td></td><td></td><td></td><td></td><td></td><td></td><td></td><td></td><td></td></tr> <tr><td>Disable</td><td></td><td></td><td></td><td></td><td></td><td></td><td></td><td></td><td></td><td></td><td></td><td></td><td></td><td></td><td></td><td></td></tr> <tr><td rowspan="2">CO 3</td><td>Enable</td><td></td><td></td><td></td><td></td><td></td><td></td><td></td><td></td><td></td><td></td><td></td><td></td><td></td><td></td><td></td><td></td></tr> <tr><td>Disable</td><td></td><td></td><td></td><td></td><td></td><td></td><td></td><td></td><td></td><td></td><td></td><td></td><td></td><td></td><td></td><td></td></tr> <tr><td rowspan="2">CO 4</td><td>Enable</td><td></td><td></td><td></td><td></td><td></td><td></td><td></td><td></td><td></td><td></td><td></td><td></td><td></td><td></td><td></td><td></td></tr> <tr><td>Disable</td><td></td><td></td><td></td><td></td><td></td><td></td><td></td><td></td><td></td><td></td><td></td><td></td><td></td><td></td><td></td><td></td></tr> <tr><td rowspan="2">CO 5</td><td>Enable</td><td></td><td></td><td></td><td></td><td></td><td></td><td></td><td></td><td></td><td></td><td></td><td></td><td></td><td></td><td></td><td></td></tr> <tr><td>Disable</td><td></td><td></td><td></td><td></td><td></td><td></td><td></td><td></td><td></td><td></td><td></td><td></td><td></td><td></td><td></td><td></td></tr> <tr><td rowspan="2">CO 6</td><td>Enable</td><td></td><td></td><td></td><td></td><td></td><td></td><td></td><td></td><td></td><td></td><td></td><td></td><td></td><td></td><td></td><td></td></tr> <tr><td>Disable</td><td></td><td></td><td></td><td></td><td></td><td></td><td></td><td></td><td></td><td></td><td></td><td></td><td></td><td></td><td></td><td></td></tr> <tr><td rowspan="2">CO 7</td><td>Enable</td><td></td><td></td><td></td><td></td><td></td><td></td><td></td><td></td><td></td><td></td><td></td><td></td><td></td><td></td><td></td><td></td></tr> <tr><td>Disable</td><td></td><td></td><td></td><td></td><td></td><td></td><td></td><td></td><td></td><td></td><td></td><td></td><td></td><td></td><td></td><td></td></tr> <tr><td rowspan="2">CO 8</td><td>Enable</td><td></td><td></td><td></td><td></td><td></td><td></td><td></td><td></td><td></td><td></td><td></td><td></td><td></td><td></td><td></td><td></td></tr> <tr><td>Disable</td><td></td><td></td><td></td><td></td><td></td><td></td><td></td><td></td><td></td><td></td><td></td><td></td><td></td><td></td><td></td><td></td></tr> <tr><td rowspan="2">CO 9</td><td>Enable</td><td></td><td></td><td></td><td></td><td></td><td></td><td></td><td></td><td></td><td></td><td></td><td></td><td></td><td></td><td></td><td></td></tr> <tr><td>Disable</td><td></td><td></td><td></td><td></td><td></td><td></td><td></td><td></td><td></td><td></td><td></td><td></td><td></td><td></td><td></td><td></td></tr> <tr><td rowspan="2">CO 10</td><td>Enable</td><td></td><td></td><td></td><td></td><td></td><td></td><td></td><td></td><td></td><td></td><td></td><td></td><td></td><td></td><td></td><td></td></tr> <tr><td>Disable</td><td></td><td></td><td></td><td></td><td></td><td></td><td></td><td></td><td></td><td></td><td></td><td></td><td></td><td></td><td></td><td></td></tr> <tr><td rowspan="2">CO 11</td><td>Enable</td><td></td><td></td><td></td><td></td><td></td><td></td><td></td><td></td><td></td><td></td><td></td><td></td><td></td><td></td><td></td><td></td></tr> <tr><td>Disable</td><td></td><td></td><td></td><td></td><td></td><td></td><td></td><td></td><td></td><td></td><td></td><td></td><td></td><td></td><td></td><td></td></tr> <tr><td rowspan="2">CO 12</td><td>Enable</td><td></td><td></td><td></td><td></td><td></td><td></td><td></td><td></td><td></td><td></td><td></td><td></td><td></td><td></td><td></td><td></td></tr> <tr><td>Disable</td><td></td><td></td><td></td><td></td><td></td><td></td><td></td><td></td><td></td><td></td><td></td><td></td><td></td><td></td><td></td><td></td></tr> </tbody> </table>			Default all jack numbers	To make program change																Jack number																			01	02	03	04	05	06	07	08	09	10	11	12	13	14	15	16	CO 1	Enable	x																	Disable																		CO 2	Enable	x																	Disable																		CO 3	Enable	x																	Disable																		CO 4	Enable	x																	Disable																		CO 5	Enable	x																	Disable																		CO 6	Enable	x																	Disable																		CO 7	Enable	x																	Disable																		CO 8	Enable	x																	Disable																		CO 9	Enable	x																	Disable																		CO 10	Enable	x																	Disable																		CO 11	Enable	x																	Disable																		CO 12	Enable	x																	Disable																				To make program change																Jack number																		17	18	19	20	21	22	23	24	25	26	27	28	29	30	31	32	CO 1	Enable																	Disable																	CO 2	Enable																	Disable																	CO 3	Enable																	Disable																	CO 4	Enable																	Disable																	CO 5	Enable																	Disable																	CO 6	Enable																	Disable																	CO 7	Enable																	Disable																	CO 8	Enable																	Disable																	CO 9	Enable																	Disable																	CO 10	Enable																	Disable																	CO 11	Enable																	Disable																	CO 12	Enable																	Disable															
		Default all jack numbers				To make program change																																																																																																																																																																																																																																																																																																																																																																																																																																																																																																																																																																																																																																																																																																																																																																																																																																																																																																																																																																																																					
			Jack number																																																																																																																																																																																																																																																																																																																																																																																																																																																																																																																																																																																																																																																																																																																																																																																																																																																																																																																																																																																																								
			01	02	03	04	05	06	07	08	09	10	11	12	13	14	15	16																																																																																																																																																																																																																																																																																																																																																																																																																																																																																																																																																																																																																																																																																																																																																																																																																																																																																																																																																																																									
CO 1	Enable	x																																																																																																																																																																																																																																																																																																																																																																																																																																																																																																																																																																																																																																																																																																																																																																																																																																																																																																																																																																																																									
	Disable																																																																																																																																																																																																																																																																																																																																																																																																																																																																																																																																																																																																																																																																																																																																																																																																																																																																																																																																																																																																										
CO 2	Enable	x																																																																																																																																																																																																																																																																																																																																																																																																																																																																																																																																																																																																																																																																																																																																																																																																																																																																																																																																																																																																									
	Disable																																																																																																																																																																																																																																																																																																																																																																																																																																																																																																																																																																																																																																																																																																																																																																																																																																																																																																																																																																																																										
CO 3	Enable	x																																																																																																																																																																																																																																																																																																																																																																																																																																																																																																																																																																																																																																																																																																																																																																																																																																																																																																																																																																																																									
	Disable																																																																																																																																																																																																																																																																																																																																																																																																																																																																																																																																																																																																																																																																																																																																																																																																																																																																																																																																																																																																										
CO 4	Enable	x																																																																																																																																																																																																																																																																																																																																																																																																																																																																																																																																																																																																																																																																																																																																																																																																																																																																																																																																																																																																									
	Disable																																																																																																																																																																																																																																																																																																																																																																																																																																																																																																																																																																																																																																																																																																																																																																																																																																																																																																																																																																																																										
CO 5	Enable	x																																																																																																																																																																																																																																																																																																																																																																																																																																																																																																																																																																																																																																																																																																																																																																																																																																																																																																																																																																																																									
	Disable																																																																																																																																																																																																																																																																																																																																																																																																																																																																																																																																																																																																																																																																																																																																																																																																																																																																																																																																																																																																										
CO 6	Enable	x																																																																																																																																																																																																																																																																																																																																																																																																																																																																																																																																																																																																																																																																																																																																																																																																																																																																																																																																																																																																									
	Disable																																																																																																																																																																																																																																																																																																																																																																																																																																																																																																																																																																																																																																																																																																																																																																																																																																																																																																																																																																																																										
CO 7	Enable	x																																																																																																																																																																																																																																																																																																																																																																																																																																																																																																																																																																																																																																																																																																																																																																																																																																																																																																																																																																																																									
	Disable																																																																																																																																																																																																																																																																																																																																																																																																																																																																																																																																																																																																																																																																																																																																																																																																																																																																																																																																																																																																										
CO 8	Enable	x																																																																																																																																																																																																																																																																																																																																																																																																																																																																																																																																																																																																																																																																																																																																																																																																																																																																																																																																																																																																									
	Disable																																																																																																																																																																																																																																																																																																																																																																																																																																																																																																																																																																																																																																																																																																																																																																																																																																																																																																																																																																																																										
CO 9	Enable	x																																																																																																																																																																																																																																																																																																																																																																																																																																																																																																																																																																																																																																																																																																																																																																																																																																																																																																																																																																																																									
	Disable																																																																																																																																																																																																																																																																																																																																																																																																																																																																																																																																																																																																																																																																																																																																																																																																																																																																																																																																																																																																										
CO 10	Enable	x																																																																																																																																																																																																																																																																																																																																																																																																																																																																																																																																																																																																																																																																																																																																																																																																																																																																																																																																																																																																									
	Disable																																																																																																																																																																																																																																																																																																																																																																																																																																																																																																																																																																																																																																																																																																																																																																																																																																																																																																																																																																																																										
CO 11	Enable	x																																																																																																																																																																																																																																																																																																																																																																																																																																																																																																																																																																																																																																																																																																																																																																																																																																																																																																																																																																																																									
	Disable																																																																																																																																																																																																																																																																																																																																																																																																																																																																																																																																																																																																																																																																																																																																																																																																																																																																																																																																																																																																										
CO 12	Enable	x																																																																																																																																																																																																																																																																																																																																																																																																																																																																																																																																																																																																																																																																																																																																																																																																																																																																																																																																																																																																									
	Disable																																																																																																																																																																																																																																																																																																																																																																																																																																																																																																																																																																																																																																																																																																																																																																																																																																																																																																																																																																																																										
		To make program change																																																																																																																																																																																																																																																																																																																																																																																																																																																																																																																																																																																																																																																																																																																																																																																																																																																																																																																																																																																																									
		Jack number																																																																																																																																																																																																																																																																																																																																																																																																																																																																																																																																																																																																																																																																																																																																																																																																																																																																																																																																																																																																									
		17	18	19	20	21	22	23	24	25	26	27	28	29	30	31	32																																																																																																																																																																																																																																																																																																																																																																																																																																																																																																																																																																																																																																																																																																																																																																																																																																																																																																																																																																																										
CO 1	Enable																																																																																																																																																																																																																																																																																																																																																																																																																																																																																																																																																																																																																																																																																																																																																																																																																																																																																																																																																																																																										
	Disable																																																																																																																																																																																																																																																																																																																																																																																																																																																																																																																																																																																																																																																																																																																																																																																																																																																																																																																																																																																																										
CO 2	Enable																																																																																																																																																																																																																																																																																																																																																																																																																																																																																																																																																																																																																																																																																																																																																																																																																																																																																																																																																																																																										
	Disable																																																																																																																																																																																																																																																																																																																																																																																																																																																																																																																																																																																																																																																																																																																																																																																																																																																																																																																																																																																																										
CO 3	Enable																																																																																																																																																																																																																																																																																																																																																																																																																																																																																																																																																																																																																																																																																																																																																																																																																																																																																																																																																																																																										
	Disable																																																																																																																																																																																																																																																																																																																																																																																																																																																																																																																																																																																																																																																																																																																																																																																																																																																																																																																																																																																																										
CO 4	Enable																																																																																																																																																																																																																																																																																																																																																																																																																																																																																																																																																																																																																																																																																																																																																																																																																																																																																																																																																																																																										
	Disable																																																																																																																																																																																																																																																																																																																																																																																																																																																																																																																																																																																																																																																																																																																																																																																																																																																																																																																																																																																																										
CO 5	Enable																																																																																																																																																																																																																																																																																																																																																																																																																																																																																																																																																																																																																																																																																																																																																																																																																																																																																																																																																																																																										
	Disable																																																																																																																																																																																																																																																																																																																																																																																																																																																																																																																																																																																																																																																																																																																																																																																																																																																																																																																																																																																																										
CO 6	Enable																																																																																																																																																																																																																																																																																																																																																																																																																																																																																																																																																																																																																																																																																																																																																																																																																																																																																																																																																																																																										
	Disable																																																																																																																																																																																																																																																																																																																																																																																																																																																																																																																																																																																																																																																																																																																																																																																																																																																																																																																																																																																																										
CO 7	Enable																																																																																																																																																																																																																																																																																																																																																																																																																																																																																																																																																																																																																																																																																																																																																																																																																																																																																																																																																																																																										
	Disable																																																																																																																																																																																																																																																																																																																																																																																																																																																																																																																																																																																																																																																																																																																																																																																																																																																																																																																																																																																																										
CO 8	Enable																																																																																																																																																																																																																																																																																																																																																																																																																																																																																																																																																																																																																																																																																																																																																																																																																																																																																																																																																																																																										
	Disable																																																																																																																																																																																																																																																																																																																																																																																																																																																																																																																																																																																																																																																																																																																																																																																																																																																																																																																																																																																																										
CO 9	Enable																																																																																																																																																																																																																																																																																																																																																																																																																																																																																																																																																																																																																																																																																																																																																																																																																																																																																																																																																																																																										
	Disable																																																																																																																																																																																																																																																																																																																																																																																																																																																																																																																																																																																																																																																																																																																																																																																																																																																																																																																																																																																																										
CO 10	Enable																																																																																																																																																																																																																																																																																																																																																																																																																																																																																																																																																																																																																																																																																																																																																																																																																																																																																																																																																																																																										
	Disable																																																																																																																																																																																																																																																																																																																																																																																																																																																																																																																																																																																																																																																																																																																																																																																																																																																																																																																																																																																																										
CO 11	Enable																																																																																																																																																																																																																																																																																																																																																																																																																																																																																																																																																																																																																																																																																																																																																																																																																																																																																																																																																																																																										
	Disable																																																																																																																																																																																																																																																																																																																																																																																																																																																																																																																																																																																																																																																																																																																																																																																																																																																																																																																																																																																																										
CO 12	Enable																																																																																																																																																																																																																																																																																																																																																																																																																																																																																																																																																																																																																																																																																																																																																																																																																																																																																																																																																																																																										
	Disable																																																																																																																																																																																																																																																																																																																																																																																																																																																																																																																																																																																																																																																																																																																																																																																																																																																																																																																																																																																																										

TO SET

PROGRAM ADDRESS

STEPS REQUIRED TO CHANGE PROGRAM

Flexible Ringing Assignment (cont.)

48

Night Mode

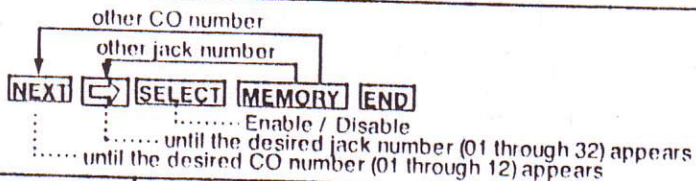

		Default all jack numbers	To make program change															
			Jack number															
CO 1	Enable	x	01	02	03	04	05	06	07	08	09	10	11	12	13	14	15	16
	Disable																	
CO 2	Enable	x																
	Disable																	
CO 3	Enable	x																
	Disable																	
CO 4	Enable	x																
	Disable																	
CO 5	Enable	x																
	Disable																	
CO 6	Enable	x																
	Disable																	
CO 7	Enable	x																
	Disable																	
CO 8	Enable	x																
	Disable																	
CO 9	Enable	x																
	Disable																	
CO 10	Enable	x																
	Disable																	
CO 11	Enable	x																
	Disable																	
CO 12	Enable	x																
	Disable																	

		To make program change																
		Jack number																
CO 1	Enable	17	18	19	20	21	22	23	24	25	26	27	28	29	30	31	32	
	Disable																	
CO 2	Enable																	
	Disable																	
CO 3	Enable																	
	Disable																	
CO 4	Enable																	
	Disable																	
CO 5	Enable																	
	Disable																	
CO 6	Enable																	
	Disable																	
CO 7	Enable																	
	Disable																	
CO 8	Enable																	
	Disable																	
CO 9	Enable																	
	Disable																	
CO 10	Enable																	
	Disable																	
CO 11	Enable																	
	Disable																	
CO 12	Enable																	
	Disable																	

PROGRAMMING TABLE (cont.)

TO SET	PROGRAM ADDRESS	STEPS REQUIRED TO CHANGE PROGRAM																																																																																																																																																																																																																																																																																																																																																																																																																																																																																																																																																																																																																																																																																																																																																																																																																																																																																																																																																																
Delayed Ringing Assignment	49	<div style="display: flex; justify-content: center; align-items: center; gap: 10px;"> <div style="text-align: center;"> <p>other CO number</p> <p>other jack number</p> <p>NEXT SELECT MEMORY END</p> </div> <div style="text-align: center;"> <p>..... Immdtly / 1ring / 2ring / 3ring</p> <p>..... until the desired jack number (01 through 32) appears</p> <p>..... until the desired CO number (01 through 12) appears</p> </div> </div>																																																																																																																																																																																																																																																																																																																																																																																																																																																																																																																																																																																																																																																																																																																																																																																																																																																																																																																																																																
		<table border="1" style="width: 100%; border-collapse: collapse; text-align: center;"> <thead> <tr> <th colspan="2" rowspan="2"></th> <th rowspan="2">Default all jack numbers</th> <th colspan="16">To make program change</th> </tr> <tr> <th colspan="16">Jack number</th> </tr> <tr> <th></th> <th></th> <th></th> <th>01</th><th>02</th><th>03</th><th>04</th><th>05</th><th>06</th><th>07</th><th>08</th><th>09</th><th>10</th><th>11</th><th>12</th><th>13</th><th>14</th><th>15</th><th>16</th> </tr> </thead> <tbody> <tr> <td rowspan="4">CO 1</td> <td>Immdtly</td> <td>x</td> <td></td><td></td><td></td><td></td><td></td><td></td><td></td><td></td><td></td><td></td><td></td><td></td><td></td><td></td><td></td><td></td> </tr> <tr> <td>1ring</td> <td></td> <td></td><td></td><td></td><td></td><td></td><td></td><td></td><td></td><td></td><td></td><td></td><td></td><td></td><td></td><td></td><td></td> </tr> <tr> <td>2rings</td> <td></td> <td></td><td></td><td></td><td></td><td></td><td></td><td></td><td></td><td></td><td></td><td></td><td></td><td></td><td></td><td></td><td></td> </tr> <tr> <td>3rings</td> <td></td> <td></td><td></td><td></td><td></td><td></td><td></td><td></td><td></td><td></td><td></td><td></td><td></td><td></td><td></td><td></td><td></td> </tr> <tr> <td rowspan="4">CO 2</td> <td>Immdtly</td> <td>x</td> <td></td><td></td><td></td><td></td><td></td><td></td><td></td><td></td><td></td><td></td><td></td><td></td><td></td><td></td><td></td><td></td> </tr> <tr> <td>1ring</td> <td></td> <td></td><td></td><td></td><td></td><td></td><td></td><td></td><td></td><td></td><td></td><td></td><td></td><td></td><td></td><td></td><td></td> </tr> <tr> <td>2rings</td> <td></td> <td></td><td></td><td></td><td></td><td></td><td></td><td></td><td></td><td></td><td></td><td></td><td></td><td></td><td></td><td></td><td></td> </tr> <tr> <td>3rings</td> <td></td> <td></td><td></td><td></td><td></td><td></td><td></td><td></td><td></td><td></td><td></td><td></td><td></td><td></td><td></td><td></td><td></td> </tr> <tr> <td rowspan="4">CO 3</td> <td>Immdtly</td> <td>x</td> <td></td><td></td><td></td><td></td><td></td><td></td><td></td><td></td><td></td><td></td><td></td><td></td><td></td><td></td><td></td><td></td> </tr> <tr> <td>1ring</td> <td></td> <td></td><td></td><td></td><td></td><td></td><td></td><td></td><td></td><td></td><td></td><td></td><td></td><td></td><td></td><td></td><td></td> </tr> <tr> <td>2rings</td> <td></td> <td></td><td></td><td></td><td></td><td></td><td></td><td></td><td></td><td></td><td></td><td></td><td></td><td></td><td></td><td></td><td></td> </tr> <tr> <td>3rings</td> <td></td> <td></td><td></td><td></td><td></td><td></td><td></td><td></td><td></td><td></td><td></td><td></td><td></td><td></td><td></td><td></td><td></td> </tr> <tr> <td rowspan="4">CO 4</td> <td>Immdtly</td> <td>x</td> <td></td><td></td><td></td><td></td><td></td><td></td><td></td><td></td><td></td><td></td><td></td><td></td><td></td><td></td><td></td><td></td> </tr> <tr> <td>1ring</td> <td></td> <td></td><td></td><td></td><td></td><td></td><td></td><td></td><td></td><td></td><td></td><td></td><td></td><td></td><td></td><td></td><td></td> </tr> <tr> <td>2rings</td> <td></td> <td></td><td></td><td></td><td></td><td></td><td></td><td></td><td></td><td></td><td></td><td></td><td></td><td></td><td></td><td></td><td></td> </tr> <tr> <td>3rings</td> <td></td> <td></td><td></td><td></td><td></td><td></td><td></td><td></td><td></td><td></td><td></td><td></td><td></td><td></td><td></td><td></td><td></td> </tr> <tr> <td rowspan="4">CO 5</td> <td>Immdtly</td> <td>x</td> <td></td><td></td><td></td><td></td><td></td><td></td><td></td><td></td><td></td><td></td><td></td><td></td><td></td><td></td><td></td><td></td> </tr> <tr> <td>1ring</td> <td></td> <td></td><td></td><td></td><td></td><td></td><td></td><td></td><td></td><td></td><td></td><td></td><td></td><td></td><td></td><td></td><td></td> </tr> <tr> <td>2rings</td> <td></td> <td></td><td></td><td></td><td></td><td></td><td></td><td></td><td></td><td></td><td></td><td></td><td></td><td></td><td></td><td></td><td></td> </tr> <tr> <td>3rings</td> <td></td> <td></td><td></td><td></td><td></td><td></td><td></td><td></td><td></td><td></td><td></td><td></td><td></td><td></td><td></td><td></td><td></td> </tr> <tr> <td rowspan="4">CO 6</td> <td>Immdtly</td> <td>x</td> <td></td><td></td><td></td><td></td><td></td><td></td><td></td><td></td><td></td><td></td><td></td><td></td><td></td><td></td><td></td><td></td> </tr> <tr> <td>1ring</td> <td></td> <td></td><td></td><td></td><td></td><td></td><td></td><td></td><td></td><td></td><td></td><td></td><td></td><td></td><td></td><td></td><td></td> </tr> <tr> <td>2rings</td> <td></td> <td></td><td></td><td></td><td></td><td></td><td></td><td></td><td></td><td></td><td></td><td></td><td></td><td></td><td></td><td></td><td></td> </tr> <tr> <td>3rings</td> <td></td> <td></td><td></td><td></td><td></td><td></td><td></td><td></td><td></td><td></td><td></td><td></td><td></td><td></td><td></td><td></td><td></td> </tr> <tr> <td rowspan="4">CO 7</td> <td>Immdtly</td> <td>x</td> <td></td><td></td><td></td><td></td><td></td><td></td><td></td><td></td><td></td><td></td><td></td><td></td><td></td><td></td><td></td><td></td> </tr> <tr> <td>1ring</td> <td></td> <td></td><td></td><td></td><td></td><td></td><td></td><td></td><td></td><td></td><td></td><td></td><td></td><td></td><td></td><td></td><td></td> </tr> <tr> <td>2rings</td> <td></td> <td></td><td></td><td></td><td></td><td></td><td></td><td></td><td></td><td></td><td></td><td></td><td></td><td></td><td></td><td></td><td></td> </tr> <tr> <td>3rings</td> <td></td> <td></td><td></td><td></td><td></td><td></td><td></td><td></td><td></td><td></td><td></td><td></td><td></td><td></td><td></td><td></td><td></td> </tr> <tr> <td rowspan="4">CO 8</td> <td>Immdtly</td> <td>x</td> <td></td><td></td><td></td><td></td><td></td><td></td><td></td><td></td><td></td><td></td><td></td><td></td><td></td><td></td><td></td><td></td> </tr> <tr> <td>1ring</td> <td></td> <td></td><td></td><td></td><td></td><td></td><td></td><td></td><td></td><td></td><td></td><td></td><td></td><td></td><td></td><td></td><td></td> </tr> <tr> <td>2rings</td> <td></td> <td></td><td></td><td></td><td></td><td></td><td></td><td></td><td></td><td></td><td></td><td></td><td></td><td></td><td></td><td></td><td></td> </tr> <tr> <td>3rings</td> <td></td> <td></td><td></td><td></td><td></td><td></td><td></td><td></td><td></td><td></td><td></td><td></td><td></td><td></td><td></td><td></td><td></td> </tr> <tr> <td rowspan="4">CO 9</td> <td>Immdtly</td> <td>x</td> <td></td><td></td><td></td><td></td><td></td><td></td><td></td><td></td><td></td><td></td><td></td><td></td><td></td><td></td><td></td><td></td> </tr> <tr> <td>1ring</td> <td></td> <td></td><td></td><td></td><td></td><td></td><td></td><td></td><td></td><td></td><td></td><td></td><td></td><td></td><td></td><td></td><td></td> </tr> <tr> <td>2rings</td> <td></td> <td></td><td></td><td></td><td></td><td></td><td></td><td></td><td></td><td></td><td></td><td></td><td></td><td></td><td></td><td></td><td></td> </tr> <tr> <td>3rings</td> <td></td> <td></td><td></td><td></td><td></td><td></td><td></td><td></td><td></td><td></td><td></td><td></td><td></td><td></td><td></td><td></td><td></td> </tr> <tr> <td rowspan="4">CO 10</td> <td>Immdtly</td> <td>x</td> <td></td><td></td><td></td><td></td><td></td><td></td><td></td><td></td><td></td><td></td><td></td><td></td><td></td><td></td><td></td><td></td> </tr> <tr> <td>1ring</td> <td></td> <td></td><td></td><td></td><td></td><td></td><td></td><td></td><td></td><td></td><td></td><td></td><td></td><td></td><td></td><td></td><td></td> </tr> <tr> <td>2rings</td> <td></td> <td></td><td></td><td></td><td></td><td></td><td></td><td></td><td></td><td></td><td></td><td></td><td></td><td></td><td></td><td></td><td></td> </tr> <tr> <td>3rings</td> <td></td> <td></td><td></td><td></td><td></td><td></td><td></td><td></td><td></td><td></td><td></td><td></td><td></td><td></td><td></td><td></td><td></td> </tr> <tr> <td rowspan="4">CO 11</td> <td>Immdtly</td> <td>x</td> <td></td><td></td><td></td><td></td><td></td><td></td><td></td><td></td><td></td><td></td><td></td><td></td><td></td><td></td><td></td><td></td> </tr> <tr> <td>1ring</td> <td></td> <td></td><td></td><td></td><td></td><td></td><td></td><td></td><td></td><td></td><td></td><td></td><td></td><td></td><td></td><td></td><td></td> </tr> <tr> <td>2rings</td> <td></td> <td></td><td></td><td></td><td></td><td></td><td></td><td></td><td></td><td></td><td></td><td></td><td></td><td></td><td></td><td></td><td></td> </tr> <tr> <td>3rings</td> <td></td> <td></td><td></td><td></td><td></td><td></td><td></td><td></td><td></td><td></td><td></td><td></td><td></td><td></td><td></td><td></td><td></td> </tr> <tr> <td rowspan="4">CO 12</td> <td>Immdtly</td> <td>x</td> <td></td><td></td><td></td><td></td><td></td><td></td><td></td><td></td><td></td><td></td><td></td><td></td><td></td><td></td><td></td><td></td> </tr> <tr> <td>1ring</td> <td></td> <td></td><td></td><td></td><td></td><td></td><td></td><td></td><td></td><td></td><td></td><td></td><td></td><td></td><td></td><td></td><td></td> </tr> <tr> <td>2rings</td> <td></td> <td></td><td></td><td></td><td></td><td></td><td></td><td></td><td></td><td></td><td></td><td></td><td></td><td></td><td></td><td></td><td></td> </tr> <tr> <td>3rings</td> <td></td> <td></td><td></td><td></td><td></td><td></td><td></td><td></td><td></td><td></td><td></td><td></td><td></td><td></td><td></td><td></td><td></td> </tr> </tbody> </table>			Default all jack numbers	To make program change																Jack number																			01	02	03	04	05	06	07	08	09	10	11	12	13	14	15	16	CO 1	Immdtly	x																	1ring																		2rings																		3rings																		CO 2	Immdtly	x																	1ring																		2rings																		3rings																		CO 3	Immdtly	x																	1ring																		2rings																		3rings																		CO 4	Immdtly	x																	1ring																		2rings																		3rings																		CO 5	Immdtly	x																	1ring																		2rings																		3rings																		CO 6	Immdtly	x																	1ring																		2rings																		3rings																		CO 7	Immdtly	x																	1ring																		2rings																		3rings																		CO 8	Immdtly	x																	1ring																		2rings																		3rings																		CO 9	Immdtly	x																	1ring																		2rings																		3rings																		CO 10	Immdtly	x																	1ring																		2rings																		3rings																		CO 11	Immdtly	x																	1ring																		2rings																		3rings																		CO 12	Immdtly	x																	1ring																		2rings																		3rings															
		Default all jack numbers				To make program change																																																																																																																																																																																																																																																																																																																																																																																																																																																																																																																																																																																																																																																																																																																																																																																																																																																																																																																																																												
			Jack number																																																																																																																																																																																																																																																																																																																																																																																																																																																																																																																																																																																																																																																																																																																																																																																																																																																																																																																																																															
			01	02	03	04	05	06	07	08	09	10	11	12	13	14	15	16																																																																																																																																																																																																																																																																																																																																																																																																																																																																																																																																																																																																																																																																																																																																																																																																																																																																																																																																																
CO 1	Immdtly	x																																																																																																																																																																																																																																																																																																																																																																																																																																																																																																																																																																																																																																																																																																																																																																																																																																																																																																																																																																
	1ring																																																																																																																																																																																																																																																																																																																																																																																																																																																																																																																																																																																																																																																																																																																																																																																																																																																																																																																																																																	
	2rings																																																																																																																																																																																																																																																																																																																																																																																																																																																																																																																																																																																																																																																																																																																																																																																																																																																																																																																																																																	
	3rings																																																																																																																																																																																																																																																																																																																																																																																																																																																																																																																																																																																																																																																																																																																																																																																																																																																																																																																																																																	
CO 2	Immdtly	x																																																																																																																																																																																																																																																																																																																																																																																																																																																																																																																																																																																																																																																																																																																																																																																																																																																																																																																																																																
	1ring																																																																																																																																																																																																																																																																																																																																																																																																																																																																																																																																																																																																																																																																																																																																																																																																																																																																																																																																																																	
	2rings																																																																																																																																																																																																																																																																																																																																																																																																																																																																																																																																																																																																																																																																																																																																																																																																																																																																																																																																																																	
	3rings																																																																																																																																																																																																																																																																																																																																																																																																																																																																																																																																																																																																																																																																																																																																																																																																																																																																																																																																																																	
CO 3	Immdtly	x																																																																																																																																																																																																																																																																																																																																																																																																																																																																																																																																																																																																																																																																																																																																																																																																																																																																																																																																																																
	1ring																																																																																																																																																																																																																																																																																																																																																																																																																																																																																																																																																																																																																																																																																																																																																																																																																																																																																																																																																																	
	2rings																																																																																																																																																																																																																																																																																																																																																																																																																																																																																																																																																																																																																																																																																																																																																																																																																																																																																																																																																																	
	3rings																																																																																																																																																																																																																																																																																																																																																																																																																																																																																																																																																																																																																																																																																																																																																																																																																																																																																																																																																																	
CO 4	Immdtly	x																																																																																																																																																																																																																																																																																																																																																																																																																																																																																																																																																																																																																																																																																																																																																																																																																																																																																																																																																																
	1ring																																																																																																																																																																																																																																																																																																																																																																																																																																																																																																																																																																																																																																																																																																																																																																																																																																																																																																																																																																	
	2rings																																																																																																																																																																																																																																																																																																																																																																																																																																																																																																																																																																																																																																																																																																																																																																																																																																																																																																																																																																	
	3rings																																																																																																																																																																																																																																																																																																																																																																																																																																																																																																																																																																																																																																																																																																																																																																																																																																																																																																																																																																	
CO 5	Immdtly	x																																																																																																																																																																																																																																																																																																																																																																																																																																																																																																																																																																																																																																																																																																																																																																																																																																																																																																																																																																
	1ring																																																																																																																																																																																																																																																																																																																																																																																																																																																																																																																																																																																																																																																																																																																																																																																																																																																																																																																																																																	
	2rings																																																																																																																																																																																																																																																																																																																																																																																																																																																																																																																																																																																																																																																																																																																																																																																																																																																																																																																																																																	
	3rings																																																																																																																																																																																																																																																																																																																																																																																																																																																																																																																																																																																																																																																																																																																																																																																																																																																																																																																																																																	
CO 6	Immdtly	x																																																																																																																																																																																																																																																																																																																																																																																																																																																																																																																																																																																																																																																																																																																																																																																																																																																																																																																																																																
	1ring																																																																																																																																																																																																																																																																																																																																																																																																																																																																																																																																																																																																																																																																																																																																																																																																																																																																																																																																																																	
	2rings																																																																																																																																																																																																																																																																																																																																																																																																																																																																																																																																																																																																																																																																																																																																																																																																																																																																																																																																																																	
	3rings																																																																																																																																																																																																																																																																																																																																																																																																																																																																																																																																																																																																																																																																																																																																																																																																																																																																																																																																																																	
CO 7	Immdtly	x																																																																																																																																																																																																																																																																																																																																																																																																																																																																																																																																																																																																																																																																																																																																																																																																																																																																																																																																																																
	1ring																																																																																																																																																																																																																																																																																																																																																																																																																																																																																																																																																																																																																																																																																																																																																																																																																																																																																																																																																																	
	2rings																																																																																																																																																																																																																																																																																																																																																																																																																																																																																																																																																																																																																																																																																																																																																																																																																																																																																																																																																																	
	3rings																																																																																																																																																																																																																																																																																																																																																																																																																																																																																																																																																																																																																																																																																																																																																																																																																																																																																																																																																																	
CO 8	Immdtly	x																																																																																																																																																																																																																																																																																																																																																																																																																																																																																																																																																																																																																																																																																																																																																																																																																																																																																																																																																																
	1ring																																																																																																																																																																																																																																																																																																																																																																																																																																																																																																																																																																																																																																																																																																																																																																																																																																																																																																																																																																	
	2rings																																																																																																																																																																																																																																																																																																																																																																																																																																																																																																																																																																																																																																																																																																																																																																																																																																																																																																																																																																	
	3rings																																																																																																																																																																																																																																																																																																																																																																																																																																																																																																																																																																																																																																																																																																																																																																																																																																																																																																																																																																	
CO 9	Immdtly	x																																																																																																																																																																																																																																																																																																																																																																																																																																																																																																																																																																																																																																																																																																																																																																																																																																																																																																																																																																
	1ring																																																																																																																																																																																																																																																																																																																																																																																																																																																																																																																																																																																																																																																																																																																																																																																																																																																																																																																																																																	
	2rings																																																																																																																																																																																																																																																																																																																																																																																																																																																																																																																																																																																																																																																																																																																																																																																																																																																																																																																																																																	
	3rings																																																																																																																																																																																																																																																																																																																																																																																																																																																																																																																																																																																																																																																																																																																																																																																																																																																																																																																																																																	
CO 10	Immdtly	x																																																																																																																																																																																																																																																																																																																																																																																																																																																																																																																																																																																																																																																																																																																																																																																																																																																																																																																																																																
	1ring																																																																																																																																																																																																																																																																																																																																																																																																																																																																																																																																																																																																																																																																																																																																																																																																																																																																																																																																																																	
	2rings																																																																																																																																																																																																																																																																																																																																																																																																																																																																																																																																																																																																																																																																																																																																																																																																																																																																																																																																																																	
	3rings																																																																																																																																																																																																																																																																																																																																																																																																																																																																																																																																																																																																																																																																																																																																																																																																																																																																																																																																																																	
CO 11	Immdtly	x																																																																																																																																																																																																																																																																																																																																																																																																																																																																																																																																																																																																																																																																																																																																																																																																																																																																																																																																																																
	1ring																																																																																																																																																																																																																																																																																																																																																																																																																																																																																																																																																																																																																																																																																																																																																																																																																																																																																																																																																																	
	2rings																																																																																																																																																																																																																																																																																																																																																																																																																																																																																																																																																																																																																																																																																																																																																																																																																																																																																																																																																																	
	3rings																																																																																																																																																																																																																																																																																																																																																																																																																																																																																																																																																																																																																																																																																																																																																																																																																																																																																																																																																																	
CO 12	Immdtly	x																																																																																																																																																																																																																																																																																																																																																																																																																																																																																																																																																																																																																																																																																																																																																																																																																																																																																																																																																																
	1ring																																																																																																																																																																																																																																																																																																																																																																																																																																																																																																																																																																																																																																																																																																																																																																																																																																																																																																																																																																	
	2rings																																																																																																																																																																																																																																																																																																																																																																																																																																																																																																																																																																																																																																																																																																																																																																																																																																																																																																																																																																	
	3rings																																																																																																																																																																																																																																																																																																																																																																																																																																																																																																																																																																																																																																																																																																																																																																																																																																																																																																																																																																	

TO SET

PROGRAM ADDRESS

STEPS REQUIRED TO CHANGE PROGRAM

Delayed Ringing Assignment

Day Mode (cont.)

		To make program change															
		Jack number															
		17	18	19	20	21	22	23	24	25	26	27	28	29	30	31	32
CO 1	Immdtly																
	1ring																
	2rings																
	3rings																
CO 2	Immdtly																
	1ring																
	2rings																
	3rings																
CO 3	Immdtly																
	1ring																
	2rings																
	3rings																
CO 4	Immdtly																
	1ring																
	2rings																
	3rings																
CO 5	Immdtly																
	1ring																
	2rings																
	3rings																
CO 6	Immdtly																
	1ring																
	2rings																
	3rings																
CO 7	Immdtly																
	1ring																
	2rings																
	3rings																
CO 8	Immdtly																
	1ring																
	2rings																
	3rings																
CO 9	Immdtly																
	1ring																
	2rings																
	3rings																
CO 10	Immdtly																
	1ring																
	2rings																
	3rings																
CO 11	Immdtly																
	1ring																
	2rings																
	3rings																
CO 12	Immdtly																
	1ring																
	2rings																
	3rings																

PROGRAMMING TABLE (cont.)

TO SET	PROGRAM ADDRESS	STEPS REQUIRED TO CHANGE PROGRAM																																																																																																																																																																																																																																																																																																																																																																																																																																																																																																																																																																																																																																																																																																																																																																																																																																																																																																															
Delayed Ringing Assignment (cont.) Night Mode	50	<div style="text-align: center;"> <p style="font-size: small;"> Immdtly / 1ring / 2ring / 3ring until the desired jack number (01 through 32) appears until the desired CO number (01 through 12) appears </p> </div>																																																																																																																																																																																																																																																																																																																																																																																																																																																																																																																																																																																																																																																																																																																																																																																																																																																																																																															
		<table border="1" style="width: 100%; border-collapse: collapse; text-align: center;"> <thead> <tr> <th rowspan="3" style="width: 5%;"></th> <th rowspan="3" style="width: 10%;"></th> <th style="width: 10%;">Default</th> <th colspan="16">To make program change</th> </tr> <tr> <th rowspan="2" style="width: 10%;">all jack numbers</th> <th colspan="16">Jack number</th> </tr> <tr> <th>01</th><th>02</th><th>03</th><th>04</th><th>05</th><th>06</th><th>07</th><th>08</th><th>09</th><th>10</th><th>11</th><th>12</th><th>13</th><th>14</th><th>15</th><th>16</th> </tr> </thead> <tbody> <!-- CO 1 --> <tr> <td rowspan="4" style="text-align: center;">CO 1</td> <td style="text-align: left;">Immdtly</td> <td style="text-align: center;">x</td> <td></td><td></td><td></td><td></td><td></td><td></td><td></td><td></td><td></td><td></td><td></td><td></td><td></td><td></td><td></td> </tr> <tr> <td style="text-align: left;">1ring</td> <td></td> <td></td><td></td><td></td><td></td><td></td><td></td><td></td><td></td><td></td><td></td><td></td><td></td><td></td><td></td><td></td> </tr> <tr> <td style="text-align: left;">2rings</td> <td></td> <td></td><td></td><td></td><td></td><td></td><td></td><td></td><td></td><td></td><td></td><td></td><td></td><td></td><td></td><td></td> </tr> <tr> <td style="text-align: left;">3rings</td> <td></td> <td></td><td></td><td></td><td></td><td></td><td></td><td></td><td></td><td></td><td></td><td></td><td></td><td></td><td></td><td></td> </tr> <!-- CO 2 --> <tr> <td rowspan="4" style="text-align: center;">CO 2</td> <td style="text-align: left;">Immdtly</td> <td style="text-align: center;">x</td> <td></td><td></td><td></td><td></td><td></td><td></td><td></td><td></td><td></td><td></td><td></td><td></td><td></td><td></td><td></td> </tr> <tr> <td style="text-align: left;">1ring</td> <td></td> <td></td><td></td><td></td><td></td><td></td><td></td><td></td><td></td><td></td><td></td><td></td><td></td><td></td><td></td><td></td> </tr> <tr> <td style="text-align: left;">2rings</td> <td></td> <td></td><td></td><td></td><td></td><td></td><td></td><td></td><td></td><td></td><td></td><td></td><td></td><td></td><td></td><td></td> </tr> <tr> <td style="text-align: left;">3rings</td> <td></td> <td></td><td></td><td></td><td></td><td></td><td></td><td></td><td></td><td></td><td></td><td></td><td></td><td></td><td></td><td></td> </tr> <!-- CO 3 --> <tr> <td rowspan="4" style="text-align: center;">CO 3</td> <td style="text-align: left;">Immdtly</td> <td style="text-align: center;">x</td> <td></td><td></td><td></td><td></td><td></td><td></td><td></td><td></td><td></td><td></td><td></td><td></td><td></td><td></td><td></td> </tr> <tr> <td style="text-align: left;">1ring</td> <td></td> <td></td><td></td><td></td><td></td><td></td><td></td><td></td><td></td><td></td><td></td><td></td><td></td><td></td><td></td><td></td> </tr> <tr> <td style="text-align: left;">2rings</td> <td></td> <td></td><td></td><td></td><td></td><td></td><td></td><td></td><td></td><td></td><td></td><td></td><td></td><td></td><td></td><td></td> </tr> <tr> <td style="text-align: left;">3rings</td> <td></td> <td></td><td></td><td></td><td></td><td></td><td></td><td></td><td></td><td></td><td></td><td></td><td></td><td></td><td></td><td></td> </tr> <!-- CO 4 --> <tr> <td rowspan="4" style="text-align: center;">CO 4</td> <td style="text-align: left;">Immdtly</td> <td style="text-align: center;">x</td> <td></td><td></td><td></td><td></td><td></td><td></td><td></td><td></td><td></td><td></td><td></td><td></td><td></td><td></td><td></td> </tr> <tr> <td style="text-align: left;">1ring</td> <td></td> <td></td><td></td><td></td><td></td><td></td><td></td><td></td><td></td><td></td><td></td><td></td><td></td><td></td><td></td><td></td> </tr> <tr> <td style="text-align: left;">2rings</td> <td></td> <td></td><td></td><td></td><td></td><td></td><td></td><td></td><td></td><td></td><td></td><td></td><td></td><td></td><td></td><td></td> </tr> <tr> <td style="text-align: left;">3rings</td> <td></td> <td></td><td></td><td></td><td></td><td></td><td></td><td></td><td></td><td></td><td></td><td></td><td></td><td></td><td></td><td></td> </tr> <!-- CO 5 --> <tr> <td rowspan="4" style="text-align: center;">CO 5</td> <td style="text-align: left;">Immdtly</td> <td style="text-align: center;">x</td> <td></td><td></td><td></td><td></td><td></td><td></td><td></td><td></td><td></td><td></td><td></td><td></td><td></td><td></td><td></td> </tr> <tr> <td style="text-align: left;">1ring</td> <td></td> <td></td><td></td><td></td><td></td><td></td><td></td><td></td><td></td><td></td><td></td><td></td><td></td><td></td><td></td><td></td> </tr> <tr> <td style="text-align: left;">2rings</td> <td></td> <td></td><td></td><td></td><td></td><td></td><td></td><td></td><td></td><td></td><td></td><td></td><td></td><td></td><td></td><td></td> </tr> <tr> <td style="text-align: left;">3rings</td> <td></td> <td></td><td></td><td></td><td></td><td></td><td></td><td></td><td></td><td></td><td></td><td></td><td></td><td></td><td></td><td></td> </tr> <!-- CO 6 --> <tr> <td rowspan="4" style="text-align: center;">CO 6</td> <td style="text-align: left;">Immdtly</td> <td style="text-align: center;">x</td> <td></td><td></td><td></td><td></td><td></td><td></td><td></td><td></td><td></td><td></td><td></td><td></td><td></td><td></td><td></td> </tr> <tr> <td style="text-align: left;">1ring</td> <td></td> <td></td><td></td><td></td><td></td><td></td><td></td><td></td><td></td><td></td><td></td><td></td><td></td><td></td><td></td><td></td> </tr> <tr> <td style="text-align: left;">2rings</td> <td></td> <td></td><td></td><td></td><td></td><td></td><td></td><td></td><td></td><td></td><td></td><td></td><td></td><td></td><td></td><td></td> </tr> <tr> <td style="text-align: left;">3rings</td> <td></td> <td></td><td></td><td></td><td></td><td></td><td></td><td></td><td></td><td></td><td></td><td></td><td></td><td></td><td></td><td></td> </tr> <!-- CO 7 --> <tr> <td rowspan="4" style="text-align: center;">CO 7</td> <td style="text-align: left;">Immdtly</td> <td style="text-align: center;">x</td> <td></td><td></td><td></td><td></td><td></td><td></td><td></td><td></td><td></td><td></td><td></td><td></td><td></td><td></td><td></td> </tr> <tr> <td style="text-align: left;">1ring</td> <td></td> <td></td><td></td><td></td><td></td><td></td><td></td><td></td><td></td><td></td><td></td><td></td><td></td><td></td><td></td><td></td> </tr> <tr> <td style="text-align: left;">2rings</td> <td></td> <td></td><td></td><td></td><td></td><td></td><td></td><td></td><td></td><td></td><td></td><td></td><td></td><td></td><td></td><td></td> </tr> <tr> <td style="text-align: left;">3rings</td> <td></td> <td></td><td></td><td></td><td></td><td></td><td></td><td></td><td></td><td></td><td></td><td></td><td></td><td></td><td></td><td></td> </tr> <!-- CO 8 --> <tr> <td rowspan="4" style="text-align: center;">CO 8</td> <td style="text-align: left;">Immdtly</td> <td style="text-align: center;">x</td> <td></td><td></td><td></td><td></td><td></td><td></td><td></td><td></td><td></td><td></td><td></td><td></td><td></td><td></td><td></td> </tr> <tr> <td style="text-align: left;">1ring</td> <td></td> <td></td><td></td><td></td><td></td><td></td><td></td><td></td><td></td><td></td><td></td><td></td><td></td><td></td><td></td><td></td> </tr> <tr> <td style="text-align: left;">2rings</td> <td></td> <td></td><td></td><td></td><td></td><td></td><td></td><td></td><td></td><td></td><td></td><td></td><td></td><td></td><td></td><td></td> </tr> <tr> <td style="text-align: left;">3rings</td> <td></td> <td></td><td></td><td></td><td></td><td></td><td></td><td></td><td></td><td></td><td></td><td></td><td></td><td></td><td></td><td></td> </tr> <!-- CO 9 --> <tr> <td rowspan="4" style="text-align: center;">CO 9</td> <td style="text-align: left;">Immdtly</td> <td style="text-align: center;">x</td> <td></td><td></td><td></td><td></td><td></td><td></td><td></td><td></td><td></td><td></td><td></td><td></td><td></td><td></td><td></td> </tr> <tr> <td style="text-align: left;">1ring</td> <td></td> <td></td><td></td><td></td><td></td><td></td><td></td><td></td><td></td><td></td><td></td><td></td><td></td><td></td><td></td><td></td> </tr> <tr> <td style="text-align: left;">2rings</td> <td></td> <td></td><td></td><td></td><td></td><td></td><td></td><td></td><td></td><td></td><td></td><td></td><td></td><td></td><td></td><td></td> </tr> <tr> <td style="text-align: left;">3rings</td> <td></td> <td></td><td></td><td></td><td></td><td></td><td></td><td></td><td></td><td></td><td></td><td></td><td></td><td></td><td></td><td></td> </tr> <!-- CO 10 --> <tr> <td rowspan="4" style="text-align: center;">CO 10</td> <td style="text-align: left;">Immdtly</td> <td style="text-align: center;">x</td> <td></td><td></td><td></td><td></td><td></td><td></td><td></td><td></td><td></td><td></td><td></td><td></td><td></td><td></td><td></td> </tr> <tr> <td style="text-align: left;">1ring</td> <td></td> <td></td><td></td><td></td><td></td><td></td><td></td><td></td><td></td><td></td><td></td><td></td><td></td><td></td><td></td><td></td> </tr> <tr> <td style="text-align: left;">2rings</td> <td></td> <td></td><td></td><td></td><td></td><td></td><td></td><td></td><td></td><td></td><td></td><td></td><td></td><td></td><td></td><td></td> </tr> <tr> <td style="text-align: left;">3rings</td> <td></td> <td></td><td></td><td></td><td></td><td></td><td></td><td></td><td></td><td></td><td></td><td></td><td></td><td></td><td></td><td></td> </tr> <!-- CO 11 --> <tr> <td rowspan="4" style="text-align: center;">CO 11</td> <td style="text-align: left;">Immdtly</td> <td style="text-align: center;">x</td> <td></td><td></td><td></td><td></td><td></td><td></td><td></td><td></td><td></td><td></td><td></td><td></td><td></td><td></td><td></td> </tr> <tr> <td style="text-align: left;">1ring</td> <td></td> <td></td><td></td><td></td><td></td><td></td><td></td><td></td><td></td><td></td><td></td><td></td><td></td><td></td><td></td><td></td> </tr> <tr> <td style="text-align: left;">2rings</td> <td></td> <td></td><td></td><td></td><td></td><td></td><td></td><td></td><td></td><td></td><td></td><td></td><td></td><td></td><td></td><td></td> </tr> <tr> <td style="text-align: left;">3rings</td> <td></td> <td></td><td></td><td></td><td></td><td></td><td></td><td></td><td></td><td></td><td></td><td></td><td></td><td></td><td></td><td></td> </tr> <!-- CO 12 --> <tr> <td rowspan="4" style="text-align: center;">CO 12</td> <td style="text-align: left;">Immdtly</td> <td style="text-align: center;">x</td> <td></td><td></td><td></td><td></td><td></td><td></td><td></td><td></td><td></td><td></td><td></td><td></td><td></td><td></td><td></td> </tr> <tr> <td style="text-align: left;">1ring</td> <td></td> <td></td><td></td><td></td><td></td><td></td><td></td><td></td><td></td><td></td><td></td><td></td><td></td><td></td><td></td><td></td> </tr> <tr> <td style="text-align: left;">2rings</td> <td></td> <td></td><td></td><td></td><td></td><td></td><td></td><td></td><td></td><td></td><td></td><td></td><td></td><td></td><td></td><td></td> </tr> <tr> <td style="text-align: left;">3rings</td> <td></td> <td></td><td></td><td></td><td></td><td></td><td></td><td></td><td></td><td></td><td></td><td></td><td></td><td></td><td></td><td></td> </tr> </tbody> </table>			Default	To make program change																all jack numbers	Jack number																01	02	03	04	05	06	07	08	09	10	11	12	13	14	15	16	CO 1	Immdtly	x																1ring																	2rings																	3rings																	CO 2	Immdtly	x																1ring																	2rings																	3rings																	CO 3	Immdtly	x																1ring																	2rings																	3rings																	CO 4	Immdtly	x																1ring																	2rings																	3rings																	CO 5	Immdtly	x																1ring																	2rings																	3rings																	CO 6	Immdtly	x																1ring																	2rings																	3rings																	CO 7	Immdtly	x																1ring																	2rings																	3rings																	CO 8	Immdtly	x																1ring																	2rings																	3rings																	CO 9	Immdtly	x																1ring																	2rings																	3rings																	CO 10	Immdtly	x																1ring																	2rings																	3rings																	CO 11	Immdtly	x																1ring																	2rings																	3rings																	CO 12	Immdtly	x																1ring																	2rings																	3rings															
		Default			To make program change																																																																																																																																																																																																																																																																																																																																																																																																																																																																																																																																																																																																																																																																																																																																																																																																																																																																																																												
		all jack numbers			Jack number																																																																																																																																																																																																																																																																																																																																																																																																																																																																																																																																																																																																																																																																																																																																																																																																																																																																																																												
			01	02	03	04	05	06	07	08	09	10	11	12	13	14	15	16																																																																																																																																																																																																																																																																																																																																																																																																																																																																																																																																																																																																																																																																																																																																																																																																																																																																																															
CO 1	Immdtly	x																																																																																																																																																																																																																																																																																																																																																																																																																																																																																																																																																																																																																																																																																																																																																																																																																																																																																																															
	1ring																																																																																																																																																																																																																																																																																																																																																																																																																																																																																																																																																																																																																																																																																																																																																																																																																																																																																																																
	2rings																																																																																																																																																																																																																																																																																																																																																																																																																																																																																																																																																																																																																																																																																																																																																																																																																																																																																																																
	3rings																																																																																																																																																																																																																																																																																																																																																																																																																																																																																																																																																																																																																																																																																																																																																																																																																																																																																																																
CO 2	Immdtly	x																																																																																																																																																																																																																																																																																																																																																																																																																																																																																																																																																																																																																																																																																																																																																																																																																																																																																																															
	1ring																																																																																																																																																																																																																																																																																																																																																																																																																																																																																																																																																																																																																																																																																																																																																																																																																																																																																																																
	2rings																																																																																																																																																																																																																																																																																																																																																																																																																																																																																																																																																																																																																																																																																																																																																																																																																																																																																																																
	3rings																																																																																																																																																																																																																																																																																																																																																																																																																																																																																																																																																																																																																																																																																																																																																																																																																																																																																																																
CO 3	Immdtly	x																																																																																																																																																																																																																																																																																																																																																																																																																																																																																																																																																																																																																																																																																																																																																																																																																																																																																																															
	1ring																																																																																																																																																																																																																																																																																																																																																																																																																																																																																																																																																																																																																																																																																																																																																																																																																																																																																																																
	2rings																																																																																																																																																																																																																																																																																																																																																																																																																																																																																																																																																																																																																																																																																																																																																																																																																																																																																																																
	3rings																																																																																																																																																																																																																																																																																																																																																																																																																																																																																																																																																																																																																																																																																																																																																																																																																																																																																																																
CO 4	Immdtly	x																																																																																																																																																																																																																																																																																																																																																																																																																																																																																																																																																																																																																																																																																																																																																																																																																																																																																																															
	1ring																																																																																																																																																																																																																																																																																																																																																																																																																																																																																																																																																																																																																																																																																																																																																																																																																																																																																																																
	2rings																																																																																																																																																																																																																																																																																																																																																																																																																																																																																																																																																																																																																																																																																																																																																																																																																																																																																																																
	3rings																																																																																																																																																																																																																																																																																																																																																																																																																																																																																																																																																																																																																																																																																																																																																																																																																																																																																																																
CO 5	Immdtly	x																																																																																																																																																																																																																																																																																																																																																																																																																																																																																																																																																																																																																																																																																																																																																																																																																																																																																																															
	1ring																																																																																																																																																																																																																																																																																																																																																																																																																																																																																																																																																																																																																																																																																																																																																																																																																																																																																																																
	2rings																																																																																																																																																																																																																																																																																																																																																																																																																																																																																																																																																																																																																																																																																																																																																																																																																																																																																																																
	3rings																																																																																																																																																																																																																																																																																																																																																																																																																																																																																																																																																																																																																																																																																																																																																																																																																																																																																																																
CO 6	Immdtly	x																																																																																																																																																																																																																																																																																																																																																																																																																																																																																																																																																																																																																																																																																																																																																																																																																																																																																																															
	1ring																																																																																																																																																																																																																																																																																																																																																																																																																																																																																																																																																																																																																																																																																																																																																																																																																																																																																																																
	2rings																																																																																																																																																																																																																																																																																																																																																																																																																																																																																																																																																																																																																																																																																																																																																																																																																																																																																																																
	3rings																																																																																																																																																																																																																																																																																																																																																																																																																																																																																																																																																																																																																																																																																																																																																																																																																																																																																																																
CO 7	Immdtly	x																																																																																																																																																																																																																																																																																																																																																																																																																																																																																																																																																																																																																																																																																																																																																																																																																																																																																																															
	1ring																																																																																																																																																																																																																																																																																																																																																																																																																																																																																																																																																																																																																																																																																																																																																																																																																																																																																																																
	2rings																																																																																																																																																																																																																																																																																																																																																																																																																																																																																																																																																																																																																																																																																																																																																																																																																																																																																																																
	3rings																																																																																																																																																																																																																																																																																																																																																																																																																																																																																																																																																																																																																																																																																																																																																																																																																																																																																																																
CO 8	Immdtly	x																																																																																																																																																																																																																																																																																																																																																																																																																																																																																																																																																																																																																																																																																																																																																																																																																																																																																																															
	1ring																																																																																																																																																																																																																																																																																																																																																																																																																																																																																																																																																																																																																																																																																																																																																																																																																																																																																																																
	2rings																																																																																																																																																																																																																																																																																																																																																																																																																																																																																																																																																																																																																																																																																																																																																																																																																																																																																																																
	3rings																																																																																																																																																																																																																																																																																																																																																																																																																																																																																																																																																																																																																																																																																																																																																																																																																																																																																																																
CO 9	Immdtly	x																																																																																																																																																																																																																																																																																																																																																																																																																																																																																																																																																																																																																																																																																																																																																																																																																																																																																																															
	1ring																																																																																																																																																																																																																																																																																																																																																																																																																																																																																																																																																																																																																																																																																																																																																																																																																																																																																																																
	2rings																																																																																																																																																																																																																																																																																																																																																																																																																																																																																																																																																																																																																																																																																																																																																																																																																																																																																																																
	3rings																																																																																																																																																																																																																																																																																																																																																																																																																																																																																																																																																																																																																																																																																																																																																																																																																																																																																																																
CO 10	Immdtly	x																																																																																																																																																																																																																																																																																																																																																																																																																																																																																																																																																																																																																																																																																																																																																																																																																																																																																																															
	1ring																																																																																																																																																																																																																																																																																																																																																																																																																																																																																																																																																																																																																																																																																																																																																																																																																																																																																																																
	2rings																																																																																																																																																																																																																																																																																																																																																																																																																																																																																																																																																																																																																																																																																																																																																																																																																																																																																																																
	3rings																																																																																																																																																																																																																																																																																																																																																																																																																																																																																																																																																																																																																																																																																																																																																																																																																																																																																																																
CO 11	Immdtly	x																																																																																																																																																																																																																																																																																																																																																																																																																																																																																																																																																																																																																																																																																																																																																																																																																																																																																																															
	1ring																																																																																																																																																																																																																																																																																																																																																																																																																																																																																																																																																																																																																																																																																																																																																																																																																																																																																																																
	2rings																																																																																																																																																																																																																																																																																																																																																																																																																																																																																																																																																																																																																																																																																																																																																																																																																																																																																																																
	3rings																																																																																																																																																																																																																																																																																																																																																																																																																																																																																																																																																																																																																																																																																																																																																																																																																																																																																																																
CO 12	Immdtly	x																																																																																																																																																																																																																																																																																																																																																																																																																																																																																																																																																																																																																																																																																																																																																																																																																																																																																																															
	1ring																																																																																																																																																																																																																																																																																																																																																																																																																																																																																																																																																																																																																																																																																																																																																																																																																																																																																																																
	2rings																																																																																																																																																																																																																																																																																																																																																																																																																																																																																																																																																																																																																																																																																																																																																																																																																																																																																																																
	3rings																																																																																																																																																																																																																																																																																																																																																																																																																																																																																																																																																																																																																																																																																																																																																																																																																																																																																																																

TO SET

PROGRAM ADDRESS

STEPS REQUIRED TO CHANGE PROGRAM

Delayed Ringing Assignment

Night Mode (cont.)

		To make program change															
		Jack number															
		17	18	19	20	21	22	23	24	25	26	27	28	29	30	31	32
CO 1	Immdtly																
	1ring																
	2rings																
	3rings																
CO 2	Immdtly																
	1ring																
	2rings																
	3rings																
CO 3	Immdtly																
	1ring																
	2rings																
	3rings																
CO 4	Immdtly																
	1ring																
	2rings																
	3rings																
CO 5	Immdtly																
	1ring																
	2rings																
	3rings																
CO 6	Immdtly																
	1ring																
	2rings																
	3rings																
CO 7	Immdtly																
	1ring																
	2rings																
	3rings																
CO 8	Immdtly																
	1ring																
	2rings																
	3rings																
CO 9	Immdtly																
	1ring																
	2rings																
	3rings																
CO 10	Immdtly																
	1ring																
	2rings																
	3rings																
CO 11	Immdtly																
	1ring																
	2rings																
	3rings																
CO 12	Immdtly																
	1ring																
	2rings																
	3rings																

PROGRAMMING TABLE (cont.)

TO SET	PROGRAM ADDRESS	STEPS REQUIRED TO CHANGE PROGRAM																																																																																																																																		
CO Mode (Normal / DIL / DISA) Assignment Day Mode	51	<ul style="list-style-type: none"> ● Selecting the "Normal" or "DISA" mode <div style="margin-left: 20px;"> <table border="1" style="border-collapse: collapse; text-align: center;"> <tr> <td style="padding: 2px;">NEXT</td> <td style="padding: 2px;">SELECT</td> <td style="padding: 2px;">MEMORY</td> <td style="padding: 2px;">END</td> </tr> </table> <p style="margin-left: 40px;">..... Normal / DISA</p> <p style="margin-left: 40px;">..... until the desired CO number (01 through 12) appears</p> </div> ● Selecting the "DIL" mode <div style="margin-left: 20px;"> <table border="1" style="border-collapse: collapse; text-align: center;"> <tr> <td style="padding: 2px;">NEXT</td> <td style="padding: 2px;">SELECT</td> <td style="padding: 2px;">CD</td> <td style="padding: 2px;">MEMORY</td> <td style="padding: 2px;">END</td> </tr> </table> <p style="margin-left: 40px;">..... DIL Dial jack number (01 through 32)</p> <p style="margin-left: 40px;">..... until the desired CO number (01 through 12) appears</p> </div> <table border="1" style="width: 100%; border-collapse: collapse; text-align: center;"> <tr> <th rowspan="2" style="width: 5%;"></th> <th style="width: 10%;">Default</th> <th colspan="12">To make program change</th> </tr> <tr> <th>all CO's</th> <th colspan="12">CO number</th> </tr> <tr> <td></td> <td></td> <td>01</td><td>02</td><td>03</td><td>04</td><td>05</td><td>06</td><td>07</td><td>08</td><td>09</td><td>10</td><td>11</td><td>12</td> </tr> <tr> <td>Normal</td> <td>x</td> <td></td><td></td><td></td><td></td><td></td><td></td><td></td><td></td><td></td><td></td><td></td><td></td> </tr> <tr> <td>DIL</td> <td></td> <td></td><td></td><td></td><td></td><td></td><td></td><td></td><td></td><td></td><td></td><td></td><td></td> </tr> <tr> <td>DISA</td> <td></td> <td></td><td></td><td></td><td></td><td></td><td></td><td></td><td></td><td></td><td></td><td></td><td></td> </tr> </table> When "DIL" mode <table border="1" style="width: 100%; border-collapse: collapse; text-align: center;"> <tr> <th rowspan="2" style="width: 5%;"></th> <th colspan="12">CO number</th> </tr> <tr> <td>01</td><td>02</td><td>03</td><td>04</td><td>05</td><td>06</td><td>07</td><td>08</td><td>09</td><td>10</td><td>11</td><td>12</td> </tr> <tr> <td>Jack number</td> <td></td><td></td><td></td><td></td><td></td><td></td><td></td><td></td><td></td><td></td><td></td><td></td> </tr> </table>	NEXT	SELECT	MEMORY	END	NEXT	SELECT	CD	MEMORY	END		Default	To make program change												all CO's	CO number														01	02	03	04	05	06	07	08	09	10	11	12	Normal	x													DIL														DISA															CO number												01	02	03	04	05	06	07	08	09	10	11	12	Jack number												
NEXT	SELECT	MEMORY	END																																																																																																																																	
NEXT	SELECT	CD	MEMORY	END																																																																																																																																
	Default	To make program change																																																																																																																																		
	all CO's	CO number																																																																																																																																		
		01	02	03	04	05	06	07	08	09	10	11	12																																																																																																																							
Normal	x																																																																																																																																			
DIL																																																																																																																																				
DISA																																																																																																																																				
	CO number																																																																																																																																			
	01	02	03	04	05	06	07	08	09	10	11	12																																																																																																																								
Jack number																																																																																																																																				
Night Mode	52	<ul style="list-style-type: none"> ● Selecting the "Normal" or "DISA" mode <div style="margin-left: 20px;"> <table border="1" style="border-collapse: collapse; text-align: center;"> <tr> <td style="padding: 2px;">NEXT</td> <td style="padding: 2px;">SELECT</td> <td style="padding: 2px;">MEMORY</td> <td style="padding: 2px;">END</td> </tr> </table> <p style="margin-left: 40px;">..... Normal / DISA</p> <p style="margin-left: 40px;">..... until the desired CO number (01 through 12) appears</p> </div> ● Selecting the "DIL" mode <div style="margin-left: 20px;"> <table border="1" style="border-collapse: collapse; text-align: center;"> <tr> <td style="padding: 2px;">NEXT</td> <td style="padding: 2px;">SELECT</td> <td style="padding: 2px;">CD</td> <td style="padding: 2px;">MEMORY</td> <td style="padding: 2px;">END</td> </tr> </table> <p style="margin-left: 40px;">..... DIL Dial jack number (01 through 32)</p> <p style="margin-left: 40px;">..... until the desired CO number (01 through 12) appears</p> </div> <table border="1" style="width: 100%; border-collapse: collapse; text-align: center;"> <tr> <th rowspan="2" style="width: 5%;"></th> <th style="width: 10%;">Default</th> <th colspan="12">To make program change</th> </tr> <tr> <th>all CO's</th> <th colspan="12">CO number</th> </tr> <tr> <td></td> <td></td> <td>01</td><td>02</td><td>03</td><td>04</td><td>05</td><td>06</td><td>07</td><td>08</td><td>09</td><td>10</td><td>11</td><td>12</td> </tr> <tr> <td>Normal</td> <td></td> <td></td><td></td><td></td><td></td><td></td><td></td><td></td><td></td><td></td><td></td><td></td><td></td> </tr> <tr> <td>DIL</td> <td></td> <td></td><td></td><td></td><td></td><td></td><td></td><td></td><td></td><td></td><td></td><td></td><td></td> </tr> <tr> <td>DISA</td> <td></td> <td></td><td></td><td></td><td></td><td></td><td></td><td></td><td></td><td></td><td></td><td></td><td></td> </tr> </table> When "DIL" mode <table border="1" style="width: 100%; border-collapse: collapse; text-align: center;"> <tr> <th rowspan="2" style="width: 5%;"></th> <th colspan="12">CO number</th> </tr> <tr> <td>01</td><td>02</td><td>03</td><td>04</td><td>05</td><td>06</td><td>07</td><td>08</td><td>09</td><td>10</td><td>11</td><td>12</td> </tr> <tr> <td>Jack number</td> <td></td><td></td><td></td><td></td><td></td><td></td><td></td><td></td><td></td><td></td><td></td><td></td> </tr> </table>	NEXT	SELECT	MEMORY	END	NEXT	SELECT	CD	MEMORY	END		Default	To make program change												all CO's	CO number														01	02	03	04	05	06	07	08	09	10	11	12	Normal														DIL														DISA															CO number												01	02	03	04	05	06	07	08	09	10	11	12	Jack number												
NEXT	SELECT	MEMORY	END																																																																																																																																	
NEXT	SELECT	CD	MEMORY	END																																																																																																																																
	Default	To make program change																																																																																																																																		
	all CO's	CO number																																																																																																																																		
		01	02	03	04	05	06	07	08	09	10	11	12																																																																																																																							
Normal																																																																																																																																				
DIL																																																																																																																																				
DISA																																																																																																																																				
	CO number																																																																																																																																			
	01	02	03	04	05	06	07	08	09	10	11	12																																																																																																																								
Jack number																																																																																																																																				

TO SET	PROGRAM ADDRESS	STEPS REQUIRED TO CHANGE PROGRAM																																																																																																
Pause Time Assignment	5.3	<p style="text-align: center;"> </p> <table border="1" style="width: 100%; border-collapse: collapse;"> <thead> <tr> <th rowspan="2"></th> <th rowspan="2">Default</th> <th colspan="12">To make program change</th> </tr> <tr> <th colspan="12">CO number</th> </tr> <tr> <th></th> <th>all CO's</th> <th>01</th><th>02</th><th>03</th><th>04</th><th>05</th><th>06</th><th>07</th><th>08</th><th>09</th><th>10</th><th>11</th><th>12</th> </tr> </thead> <tbody> <tr> <td>1.5sec</td> <td></td> <td></td><td></td><td></td><td></td><td></td><td></td><td></td><td></td><td></td><td></td><td></td><td></td> </tr> <tr> <td>2.5sec</td> <td></td> <td></td><td></td><td></td><td></td><td></td><td></td><td></td><td></td><td></td><td></td><td></td><td></td> </tr> <tr> <td>3.5sec</td> <td style="text-align: center;">x</td> <td></td><td></td><td></td><td></td><td></td><td></td><td></td><td></td><td></td><td></td><td></td><td></td> </tr> <tr> <td>4.5sec</td> <td></td> <td></td><td></td><td></td><td></td><td></td><td></td><td></td><td></td><td></td><td></td><td></td><td></td> </tr> </tbody> </table>		Default	To make program change												CO number													all CO's	01	02	03	04	05	06	07	08	09	10	11	12	1.5sec														2.5sec														3.5sec	x													4.5sec													
	Default	To make program change																																																																																																
		CO number																																																																																																
	all CO's	01	02	03	04	05	06	07	08	09	10	11	12																																																																																					
1.5sec																																																																																																		
2.5sec																																																																																																		
3.5sec	x																																																																																																	
4.5sec																																																																																																		
Hookswitch Flash Timing	5.4	<p style="text-align: center;"> </p> <table border="1" style="width: 100%; border-collapse: collapse;"> <thead> <tr> <th rowspan="2"></th> <th rowspan="2">Default</th> <th colspan="12">To make program change</th> </tr> <tr> <th colspan="12">CO number</th> </tr> <tr> <th></th> <th>all CO's</th> <th>01</th><th>02</th><th>03</th><th>04</th><th>05</th><th>06</th><th>07</th><th>08</th><th>09</th><th>10</th><th>11</th><th>12</th> </tr> </thead> <tbody> <tr> <td>300ms</td> <td></td> <td></td><td></td><td></td><td></td><td></td><td></td><td></td><td></td><td></td><td></td><td></td><td></td> </tr> <tr> <td>600ms</td> <td style="text-align: center;">x</td> <td></td><td></td><td></td><td></td><td></td><td></td><td></td><td></td><td></td><td></td><td></td><td></td> </tr> <tr> <td>900ms</td> <td></td> <td></td><td></td><td></td><td></td><td></td><td></td><td></td><td></td><td></td><td></td><td></td><td></td> </tr> <tr> <td>1200ms</td> <td></td> <td></td><td></td><td></td><td></td><td></td><td></td><td></td><td></td><td></td><td></td><td></td><td></td> </tr> </tbody> </table>		Default	To make program change												CO number													all CO's	01	02	03	04	05	06	07	08	09	10	11	12	300ms														600ms	x													900ms														1200ms													
	Default	To make program change																																																																																																
		CO number																																																																																																
	all CO's	01	02	03	04	05	06	07	08	09	10	11	12																																																																																					
300ms																																																																																																		
600ms	x																																																																																																	
900ms																																																																																																		
1200ms																																																																																																		
Calling Party Control (CPC) Signal	5.5	<p style="text-align: center;"> </p> <div style="border: 1px solid black; padding: 5px; margin: 10px auto; width: 80%;"> <p>AB = 00 : Disable 01 : under 5 m seconds 02 : } is not available ... : } 05 : } 06 : 62 m seconds 07 : 70 12 : 350 ---- default (all 12 CO's) 75 : 614 See the "CPC Signal Detect Time table" page 3-61.</p> </div> <table border="1" style="width: 100%; border-collapse: collapse;"> <thead> <tr> <th rowspan="2">Default</th> <th colspan="12">To make program change</th> </tr> <tr> <th colspan="12">CO number</th> </tr> <tr> <th>all CO's</th> <th>01</th><th>02</th><th>03</th><th>04</th><th>05</th><th>06</th><th>07</th><th>08</th><th>09</th><th>10</th><th>11</th><th>12</th> </tr> </thead> <tbody> <tr> <td>350 m sec</td> <td></td><td></td><td></td><td></td><td></td><td></td><td></td><td></td><td></td><td></td><td></td><td></td> </tr> </tbody> </table>	Default	To make program change												CO number												all CO's	01	02	03	04	05	06	07	08	09	10	11	12	350 m sec																																																									
Default	To make program change																																																																																																	
	CO number																																																																																																	
all CO's	01	02	03	04	05	06	07	08	09	10	11	12																																																																																						
350 m sec																																																																																																		

PROGRAMMING TABLE (cont.)

TO SET	PROGRAM ADDRESS	STEPS REQUIRED TO CHANGE PROGRAM																																																																					
Disconnect Time	5 6	<div style="text-align: center; margin-bottom: 10px;"> </div> <table border="1" style="width: 100%; border-collapse: collapse; margin-bottom: 10px;"> <thead> <tr> <th rowspan="2"></th> <th>Default</th> <th colspan="12">To make program change</th> </tr> <tr> <th>all CO's</th> <th colspan="12">CO number</th> </tr> <tr> <th></th> <th></th> <th>01</th><th>02</th><th>03</th><th>04</th><th>05</th><th>06</th><th>07</th><th>08</th><th>09</th><th>10</th><th>11</th><th>12</th> </tr> </thead> <tbody> <tr> <td>1.5 sec</td> <td style="text-align: center;">x</td> <td></td><td></td><td></td><td></td><td></td><td></td><td></td><td></td><td></td><td></td><td></td><td></td> </tr> <tr> <td>4.0 sec</td> <td></td> <td></td><td></td><td></td><td></td><td></td><td></td><td></td><td></td><td></td><td></td><td></td><td></td> </tr> </tbody> </table>		Default	To make program change												all CO's	CO number														01	02	03	04	05	06	07	08	09	10	11	12	1.5 sec	x													4.0 sec													
	Default	To make program change																																																																					
	all CO's	CO number																																																																					
		01	02	03	04	05	06	07	08	09	10	11	12																																																										
1.5 sec	x																																																																						
4.0 sec																																																																							
Automatic Designated CO Line Access	5 7	<div style="text-align: center; margin-bottom: 10px;"> </div> <table border="1" style="width: 100%; border-collapse: collapse; margin-bottom: 10px;"> <thead> <tr> <th rowspan="2"></th> <th>Default</th> <th colspan="12">To make program change</th> </tr> <tr> <th>all Co's</th> <th colspan="12">CO number</th> </tr> <tr> <th></th> <th></th> <th>01</th><th>02</th><th>03</th><th>04</th><th>05</th><th>06</th><th>07</th><th>08</th><th>09</th><th>10</th><th>11</th><th>12</th> </tr> </thead> <tbody> <tr> <td>Enable</td> <td style="text-align: center;">x</td> <td></td><td></td><td></td><td></td><td></td><td></td><td></td><td></td><td></td><td></td><td></td><td></td> </tr> <tr> <td>Disable</td> <td></td> <td></td><td></td><td></td><td></td><td></td><td></td><td></td><td></td><td></td><td></td><td></td><td></td> </tr> </tbody> </table>		Default	To make program change												all Co's	CO number														01	02	03	04	05	06	07	08	09	10	11	12	Enable	x													Disable													
	Default	To make program change																																																																					
	all Co's	CO number																																																																					
		01	02	03	04	05	06	07	08	09	10	11	12																																																										
Enable	x																																																																						
Disable																																																																							

TO SET **PROGRAM ADDRESS** **STEPS REQUIRED TO CHANGE PROGRAM**

Extension Group Assignment

6.0

NEXT **A** **MEMORY** **END**
 dial the extension group number (1 through 8)
 until the desired jack number (01 through 32) appears

	Default	To make program change															
	all jack numbers	Jack number															
		01	02	03	04	05	06	07	08	09	10	11	12	13	14	15	16
EXT GRP-1																	
EXT GRP-2																	
EXT GRP-3																	
EXT GRP-4																	
EXT GRP-5																	
EXT GRP-6																	
EXT GRP-7																	
EXT GRP-8																	

	To make program change															
	Jack number															
	17	18	19	20	21	22	23	24	25	26	27	28	29	30	31	32
EXT GRP-1																
EXT GRP-2																
EXT GRP-3																
EXT GRP-4																
EXT GRP-5																
EXT GRP-6																
EXT GRP-7																
EXT GRP-8																

Service Class Assignment of Toll Restriction

Day Mode

6.1

NEXT **E** **MEMORY** **END**
 dial the service class number (1 through 5)
 until the desired jack number (01 through 32) appears

	Default	To make program change															
	all jack numbers	Jack number															
		01	02	03	04	05	06	07	08	09	10	11	12	13	14	15	16
Class 1	x	x															
Class 2																	
Class 3																	
Class 4																	
Class 5			x														

	To make program change															
	Jack number															
	17	18	19	20	21	22	23	24	25	26	27	28	29	30	31	32
Class 1																
Class 2																
Class 3																
Class 4																
Class 5																

PROGRAMMING TABLE (cont.)

TO SET	PROGRAM ADDRESS	STEPS REQUIRED TO CHANGE PROGRAM																																																																																																																																																																																																																																																																														
<p>Service Class Assignment of Toll Restriction (cont.)</p> <p>Night Mode</p>	<p>6 2</p>	<div style="text-align: center;"> <p>..... dial the service class number (1 through 5)</p> <p>..... until the desired jack number (01 through 32) appears</p> </div> <table border="1" style="width: 100%; border-collapse: collapse; margin-top: 10px;"> <thead> <tr> <th rowspan="3" style="width: 10%;"></th> <th style="width: 10%;">Default</th> <th colspan="16">To make program change</th> </tr> <tr> <th rowspan="2">all jack numbers</th> <th colspan="16">Jack number</th> </tr> <tr> <th>01</th><th>02</th><th>03</th><th>04</th><th>05</th><th>06</th><th>07</th><th>08</th><th>09</th><th>10</th><th>11</th><th>12</th><th>13</th><th>14</th><th>15</th><th>16</th> </tr> </thead> <tbody> <tr> <td>Class 1</td> <td style="text-align: center;">x</td> <td></td><td></td><td></td><td></td><td></td><td></td><td></td><td></td><td></td><td></td><td></td><td></td><td></td><td></td><td></td> </tr> <tr> <td>Class 2</td> <td></td><td></td><td></td><td></td><td></td><td></td><td></td><td></td><td></td><td></td><td></td><td></td><td></td><td></td><td></td><td></td> </tr> <tr> <td>Class 3</td> <td></td><td></td><td></td><td></td><td></td><td></td><td></td><td></td><td></td><td></td><td></td><td></td><td></td><td></td><td></td><td></td> </tr> <tr> <td>Class 4</td> <td></td><td></td><td></td><td></td><td></td><td></td><td></td><td></td><td></td><td></td><td></td><td></td><td></td><td></td><td></td><td></td> </tr> <tr> <td>Class 5</td> <td></td><td></td><td></td><td></td><td></td><td></td><td></td><td></td><td></td><td></td><td></td><td></td><td></td><td></td><td></td><td></td> </tr> </tbody> </table> <table border="1" style="width: 100%; border-collapse: collapse; margin-top: 10px;"> <thead> <tr> <th rowspan="3" style="width: 10%;"></th> <th colspan="16">To make program change</th> </tr> <tr> <th colspan="16">Jack number</th> </tr> <tr> <th>17</th><th>18</th><th>19</th><th>20</th><th>21</th><th>22</th><th>23</th><th>24</th><th>25</th><th>26</th><th>27</th><th>28</th><th>29</th><th>30</th><th>31</th><th>32</th> </tr> </thead> <tbody> <tr> <td>Class 1</td> <td></td><td></td><td></td><td></td><td></td><td></td><td></td><td></td><td></td><td></td><td></td><td></td><td></td><td></td><td></td><td></td> </tr> <tr> <td>Class 2</td> <td></td><td></td><td></td><td></td><td></td><td></td><td></td><td></td><td></td><td></td><td></td><td></td><td></td><td></td><td></td><td></td> </tr> <tr> <td>Class 3</td> <td></td><td></td><td></td><td></td><td></td><td></td><td></td><td></td><td></td><td></td><td></td><td></td><td></td><td></td><td></td><td></td> </tr> <tr> <td>Class 4</td> <td></td><td></td><td></td><td></td><td></td><td></td><td></td><td></td><td></td><td></td><td></td><td></td><td></td><td></td><td></td><td></td> </tr> <tr> <td>Class 5</td> <td></td><td></td><td></td><td></td><td></td><td></td><td></td><td></td><td></td><td></td><td></td><td></td><td></td><td></td><td></td><td></td> </tr> </tbody> </table>		Default	To make program change																all jack numbers	Jack number																01	02	03	04	05	06	07	08	09	10	11	12	13	14	15	16	Class 1	x																Class 2																	Class 3																	Class 4																	Class 5																		To make program change																Jack number																17	18	19	20	21	22	23	24	25	26	27	28	29	30	31	32	Class 1																	Class 2																	Class 3																	Class 4																	Class 5																
	Default	To make program change																																																																																																																																																																																																																																																																														
	all jack numbers	Jack number																																																																																																																																																																																																																																																																														
		01	02	03	04	05	06	07	08	09	10	11	12	13	14	15	16																																																																																																																																																																																																																																																															
Class 1	x																																																																																																																																																																																																																																																																															
Class 2																																																																																																																																																																																																																																																																																
Class 3																																																																																																																																																																																																																																																																																
Class 4																																																																																																																																																																																																																																																																																
Class 5																																																																																																																																																																																																																																																																																
	To make program change																																																																																																																																																																																																																																																																															
	Jack number																																																																																																																																																																																																																																																																															
	17	18	19	20	21	22	23	24	25	26	27	28	29	30	31	32																																																																																																																																																																																																																																																																
Class 1																																																																																																																																																																																																																																																																																
Class 2																																																																																																																																																																																																																																																																																
Class 3																																																																																																																																																																																																																																																																																
Class 4																																																																																																																																																																																																																																																																																
Class 5																																																																																																																																																																																																																																																																																
<p>Extension Name</p>	<p>6 3</p>	<div style="text-align: center;"> <p>..... until the desired letter appears</p> <p>..... dial (0 through 9, *, or #)</p> <p>..... until the desired jack number (01 through 32) appears</p> </div>																																																																																																																																																																																																																																																																														
<p>Account Code Input Mode</p>	<p>6 4</p>	<div style="text-align: center;"> <p>..... Option / Forced</p> <p>..... until the desired jack number (01 through 32) appears</p> </div> <table border="1" style="width: 100%; border-collapse: collapse; margin-top: 10px;"> <thead> <tr> <th rowspan="3" style="width: 10%;"></th> <th style="width: 10%;">Default</th> <th colspan="16">To make program change</th> </tr> <tr> <th rowspan="2">all jack numbers</th> <th colspan="16">Jack number</th> </tr> <tr> <th>01</th><th>02</th><th>03</th><th>04</th><th>05</th><th>06</th><th>07</th><th>08</th><th>09</th><th>10</th><th>11</th><th>12</th><th>13</th><th>14</th><th>15</th><th>16</th> </tr> </thead> <tbody> <tr> <td>Option</td> <td style="text-align: center;">x</td> <td></td><td></td><td></td><td></td><td></td><td></td><td></td><td></td><td></td><td></td><td></td><td></td><td></td><td></td><td></td> </tr> <tr> <td>Forced</td> <td></td> <td></td><td></td><td></td><td></td><td></td><td></td><td></td><td></td><td></td><td></td><td></td><td></td><td></td><td></td><td></td> </tr> </tbody> </table> <table border="1" style="width: 100%; border-collapse: collapse; margin-top: 10px;"> <thead> <tr> <th rowspan="3" style="width: 10%;"></th> <th colspan="16">To make program change</th> </tr> <tr> <th colspan="16">Jack number</th> </tr> <tr> <th>17</th><th>18</th><th>19</th><th>20</th><th>21</th><th>22</th><th>23</th><th>24</th><th>25</th><th>26</th><th>27</th><th>28</th><th>29</th><th>30</th><th>31</th><th>32</th> </tr> </thead> <tbody> <tr> <td>Option</td> <td></td><td></td><td></td><td></td><td></td><td></td><td></td><td></td><td></td><td></td><td></td><td></td><td></td><td></td><td></td><td></td> </tr> <tr> <td>Forced</td> <td></td><td></td><td></td><td></td><td></td><td></td><td></td><td></td><td></td><td></td><td></td><td></td><td></td><td></td><td></td><td></td> </tr> </tbody> </table>		Default	To make program change																all jack numbers	Jack number																01	02	03	04	05	06	07	08	09	10	11	12	13	14	15	16	Option	x																Forced																		To make program change																Jack number																17	18	19	20	21	22	23	24	25	26	27	28	29	30	31	32	Option																	Forced																																																																																																																						
	Default	To make program change																																																																																																																																																																																																																																																																														
	all jack numbers	Jack number																																																																																																																																																																																																																																																																														
		01	02	03	04	05	06	07	08	09	10	11	12	13	14	15	16																																																																																																																																																																																																																																																															
Option	x																																																																																																																																																																																																																																																																															
Forced																																																																																																																																																																																																																																																																																
	To make program change																																																																																																																																																																																																																																																																															
	Jack number																																																																																																																																																																																																																																																																															
	17	18	19	20	21	22	23	24	25	26	27	28	29	30	31	32																																																																																																																																																																																																																																																																
Option																																																																																																																																																																																																																																																																																
Forced																																																																																																																																																																																																																																																																																

TO SET	PROGRAM ADDRESS	STEPS REQUIRED TO CHANGE PROGRAM																																																																																																																																																																													
Call Transfer To Outside Line	65	<p style="text-align: center;"> NEXT SELECT MEMORY END </p> <p style="text-align: center;"> Enable / Disable until the desired jack number (01 through 32) appears </p> <table border="1" style="width: 100%; border-collapse: collapse;"> <thead> <tr> <th rowspan="2" style="width: 5%;"></th> <th style="width: 10%;">Default</th> <th colspan="16">To make program change</th> </tr> <tr> <th style="text-align: center;">all jack numbers</th> <th colspan="16" style="text-align: center;">Jack number</th> </tr> <tr> <th></th> <th></th> <th>01</th><th>02</th><th>03</th><th>04</th><th>05</th><th>06</th><th>07</th><th>08</th><th>09</th><th>10</th><th>11</th><th>12</th><th>13</th><th>14</th><th>15</th><th>16</th> </tr> </thead> <tbody> <tr> <td>Enable</td> <td></td> <td></td><td></td><td></td><td></td><td></td><td></td><td></td><td></td><td></td><td></td><td></td><td></td><td></td><td></td><td></td><td></td> </tr> <tr> <td>Disable</td> <td></td> <td></td><td></td><td></td><td></td><td></td><td></td><td></td><td></td><td></td><td></td><td></td><td></td><td></td><td></td><td></td><td></td> </tr> </tbody> </table> <table border="1" style="width: 100%; border-collapse: collapse;"> <thead> <tr> <th rowspan="2" style="width: 5%;"></th> <th colspan="16">To make program change</th> </tr> <tr> <th colspan="16" style="text-align: center;">Jack number</th> </tr> <tr> <th></th> <th>17</th><th>18</th><th>19</th><th>20</th><th>21</th><th>22</th><th>23</th><th>24</th><th>25</th><th>26</th><th>27</th><th>28</th><th>29</th><th>30</th><th>31</th><th>32</th> </tr> </thead> <tbody> <tr> <td>Enable</td> <td></td><td></td><td></td><td></td><td></td><td></td><td></td><td></td><td></td><td></td><td></td><td></td><td></td><td></td><td></td><td></td> </tr> <tr> <td>Disable</td> <td></td><td></td><td></td><td></td><td></td><td></td><td></td><td></td><td></td><td></td><td></td><td></td><td></td><td></td><td></td><td></td> </tr> </tbody> </table>		Default	To make program change																all jack numbers	Jack number																		01	02	03	04	05	06	07	08	09	10	11	12	13	14	15	16	Enable																		Disable																			To make program change																Jack number																	17	18	19	20	21	22	23	24	25	26	27	28	29	30	31	32	Enable																	Disable																
	Default	To make program change																																																																																																																																																																													
	all jack numbers	Jack number																																																																																																																																																																													
		01	02	03	04	05	06	07	08	09	10	11	12	13	14	15	16																																																																																																																																																														
Enable																																																																																																																																																																															
Disable																																																																																																																																																																															
	To make program change																																																																																																																																																																														
	Jack number																																																																																																																																																																														
	17	18	19	20	21	22	23	24	25	26	27	28	29	30	31	32																																																																																																																																																															
Enable																																																																																																																																																																															
Disable																																																																																																																																																																															
Call Forwarding To Outside Line	66	<p style="text-align: center;"> NEXT SELECT MEMORY END </p> <p style="text-align: center;"> Enable / Disable until the desired jack number (01 through 32) appears </p> <table border="1" style="width: 100%; border-collapse: collapse;"> <thead> <tr> <th rowspan="2" style="width: 5%;"></th> <th style="width: 10%;">Default</th> <th colspan="16">To make program change</th> </tr> <tr> <th style="text-align: center;">all jack numbers</th> <th colspan="16" style="text-align: center;">Jack number</th> </tr> <tr> <th></th> <th></th> <th>01</th><th>02</th><th>03</th><th>04</th><th>05</th><th>06</th><th>07</th><th>08</th><th>09</th><th>10</th><th>11</th><th>12</th><th>13</th><th>14</th><th>15</th><th>16</th> </tr> </thead> <tbody> <tr> <td>Enable</td> <td></td> <td></td><td></td><td></td><td></td><td></td><td></td><td></td><td></td><td></td><td></td><td></td><td></td><td></td><td></td><td></td><td></td> </tr> <tr> <td>Disable</td> <td></td> <td></td><td></td><td></td><td></td><td></td><td></td><td></td><td></td><td></td><td></td><td></td><td></td><td></td><td></td><td></td><td></td> </tr> </tbody> </table> <table border="1" style="width: 100%; border-collapse: collapse;"> <thead> <tr> <th rowspan="2" style="width: 5%;"></th> <th colspan="16">To make program change</th> </tr> <tr> <th colspan="16" style="text-align: center;">Jack number</th> </tr> <tr> <th></th> <th>17</th><th>18</th><th>19</th><th>20</th><th>21</th><th>22</th><th>23</th><th>24</th><th>25</th><th>26</th><th>27</th><th>28</th><th>29</th><th>30</th><th>31</th><th>32</th> </tr> </thead> <tbody> <tr> <td>Enable</td> <td></td><td></td><td></td><td></td><td></td><td></td><td></td><td></td><td></td><td></td><td></td><td></td><td></td><td></td><td></td><td></td> </tr> <tr> <td>Disable</td> <td></td><td></td><td></td><td></td><td></td><td></td><td></td><td></td><td></td><td></td><td></td><td></td><td></td><td></td><td></td><td></td> </tr> </tbody> </table>		Default	To make program change																all jack numbers	Jack number																		01	02	03	04	05	06	07	08	09	10	11	12	13	14	15	16	Enable																		Disable																			To make program change																Jack number																	17	18	19	20	21	22	23	24	25	26	27	28	29	30	31	32	Enable																	Disable																
	Default	To make program change																																																																																																																																																																													
	all jack numbers	Jack number																																																																																																																																																																													
		01	02	03	04	05	06	07	08	09	10	11	12	13	14	15	16																																																																																																																																																														
Enable																																																																																																																																																																															
Disable																																																																																																																																																																															
	To make program change																																																																																																																																																																														
	Jack number																																																																																																																																																																														
	17	18	19	20	21	22	23	24	25	26	27	28	29	30	31	32																																																																																																																																																															
Enable																																																																																																																																																																															
Disable																																																																																																																																																																															
Executive Override	67	<p style="text-align: center;"> NEXT SELECT MEMORY END </p> <p style="text-align: center;"> Enable / Disable until the desired jack number (01 through 32) appears </p> <table border="1" style="width: 100%; border-collapse: collapse;"> <thead> <tr> <th rowspan="2" style="width: 5%;"></th> <th style="width: 10%;">Default</th> <th colspan="16">To make program change</th> </tr> <tr> <th style="text-align: center;">all jack numbers</th> <th colspan="16" style="text-align: center;">Jack number</th> </tr> <tr> <th></th> <th></th> <th>01</th><th>02</th><th>03</th><th>04</th><th>05</th><th>06</th><th>07</th><th>08</th><th>09</th><th>10</th><th>11</th><th>12</th><th>13</th><th>14</th><th>15</th><th>16</th> </tr> </thead> <tbody> <tr> <td>Enable</td> <td></td> <td></td><td></td><td></td><td></td><td></td><td></td><td></td><td></td><td></td><td></td><td></td><td></td><td></td><td></td><td></td><td></td> </tr> <tr> <td>Disable</td> <td></td> <td></td><td></td><td></td><td></td><td></td><td></td><td></td><td></td><td></td><td></td><td></td><td></td><td></td><td></td><td></td><td></td> </tr> </tbody> </table> <table border="1" style="width: 100%; border-collapse: collapse;"> <thead> <tr> <th rowspan="2" style="width: 5%;"></th> <th colspan="16">To make program change</th> </tr> <tr> <th colspan="16" style="text-align: center;">Jack number</th> </tr> <tr> <th></th> <th>17</th><th>18</th><th>19</th><th>20</th><th>21</th><th>22</th><th>23</th><th>24</th><th>25</th><th>26</th><th>27</th><th>28</th><th>29</th><th>30</th><th>31</th><th>32</th> </tr> </thead> <tbody> <tr> <td>Enable</td> <td></td><td></td><td></td><td></td><td></td><td></td><td></td><td></td><td></td><td></td><td></td><td></td><td></td><td></td><td></td><td></td> </tr> <tr> <td>Disable</td> <td></td><td></td><td></td><td></td><td></td><td></td><td></td><td></td><td></td><td></td><td></td><td></td><td></td><td></td><td></td><td></td> </tr> </tbody> </table>		Default	To make program change																all jack numbers	Jack number																		01	02	03	04	05	06	07	08	09	10	11	12	13	14	15	16	Enable																		Disable																			To make program change																Jack number																	17	18	19	20	21	22	23	24	25	26	27	28	29	30	31	32	Enable																	Disable																
	Default	To make program change																																																																																																																																																																													
	all jack numbers	Jack number																																																																																																																																																																													
		01	02	03	04	05	06	07	08	09	10	11	12	13	14	15	16																																																																																																																																																														
Enable																																																																																																																																																																															
Disable																																																																																																																																																																															
	To make program change																																																																																																																																																																														
	Jack number																																																																																																																																																																														
	17	18	19	20	21	22	23	24	25	26	27	28	29	30	31	32																																																																																																																																																															
Enable																																																																																																																																																																															
Disable																																																																																																																																																																															

PROGRAMMING TABLE (cont.)

TO SET	PROGRAM ADDRESS	STEPS REQUIRED TO CHANGE PROGRAM																																																																																																																																																																																																																																																						
Do not Disturb Override	68	<div style="text-align: center;"> </div> <table border="1" style="width: 100%; border-collapse: collapse; margin-bottom: 10px;"> <thead> <tr> <th rowspan="2"></th> <th rowspan="2">Default</th> <th colspan="16">To make program change</th> </tr> <tr> <th colspan="16">Jack number</th> </tr> <tr> <th></th> <th>all jack numbers</th> <th>01</th><th>02</th><th>03</th><th>04</th><th>05</th><th>06</th><th>07</th><th>08</th><th>09</th><th>10</th><th>11</th><th>12</th><th>13</th><th>14</th><th>15</th><th>16</th> </tr> </thead> <tbody> <tr> <td>Enable</td> <td></td> <td></td><td></td><td></td><td></td><td></td><td></td><td></td><td></td><td></td><td></td><td></td><td></td><td></td><td></td><td></td><td></td> </tr> <tr> <td>Disable</td> <td style="text-align: center;">x</td> <td></td><td></td><td></td><td></td><td></td><td></td><td></td><td></td><td></td><td></td><td></td><td></td><td></td><td></td><td></td><td></td> </tr> </tbody> </table> <table border="1" style="width: 100%; border-collapse: collapse;"> <thead> <tr> <th rowspan="2"></th> <th colspan="16">To make program change</th> </tr> <tr> <th colspan="16">Jack number</th> </tr> <tr> <th></th> <th>17</th><th>18</th><th>19</th><th>20</th><th>21</th><th>22</th><th>23</th><th>24</th><th>25</th><th>26</th><th>27</th><th>28</th><th>29</th><th>30</th><th>31</th><th>32</th> </tr> </thead> <tbody> <tr> <td>Enable</td> <td></td><td></td><td></td><td></td><td></td><td></td><td></td><td></td><td></td><td></td><td></td><td></td><td></td><td></td><td></td><td></td> </tr> <tr> <td>Disable</td> <td></td><td></td><td></td><td></td><td></td><td></td><td></td><td></td><td></td><td></td><td></td><td></td><td></td><td></td><td></td><td></td> </tr> </tbody> </table>		Default	To make program change																Jack number																	all jack numbers	01	02	03	04	05	06	07	08	09	10	11	12	13	14	15	16	Enable																		Disable	x																		To make program change																Jack number																	17	18	19	20	21	22	23	24	25	26	27	28	29	30	31	32	Enable																	Disable																																																																																										
	Default	To make program change																																																																																																																																																																																																																																																						
		Jack number																																																																																																																																																																																																																																																						
	all jack numbers	01	02	03	04	05	06	07	08	09	10	11	12	13	14	15	16																																																																																																																																																																																																																																							
Enable																																																																																																																																																																																																																																																								
Disable	x																																																																																																																																																																																																																																																							
	To make program change																																																																																																																																																																																																																																																							
	Jack number																																																																																																																																																																																																																																																							
	17	18	19	20	21	22	23	24	25	26	27	28	29	30	31	32																																																																																																																																																																																																																																								
Enable																																																																																																																																																																																																																																																								
Disable																																																																																																																																																																																																																																																								
Standard Telephone Connection with Proprietary Telephone	69	<div style="text-align: center;"> </div> <table border="1" style="width: 100%; border-collapse: collapse; margin-bottom: 10px;"> <thead> <tr> <th rowspan="2"></th> <th rowspan="2">Default</th> <th colspan="16">To make program change</th> </tr> <tr> <th colspan="16">Jack number</th> </tr> <tr> <th></th> <th>all jack numbers</th> <th>01</th><th>02</th><th>03</th><th>04</th><th>05</th><th>06</th><th>07</th><th>08</th><th>09</th><th>10</th><th>11</th><th>12</th><th>13</th><th>14</th><th>15</th><th>16</th> </tr> </thead> <tbody> <tr> <td>Enable</td> <td></td> <td></td><td></td><td></td><td></td><td></td><td></td><td></td><td></td><td></td><td></td><td></td><td></td><td></td><td></td><td></td><td></td> </tr> <tr> <td>Disable</td> <td style="text-align: center;">x</td> <td></td><td></td><td></td><td></td><td></td><td></td><td></td><td></td><td></td><td></td><td></td><td></td><td></td><td></td><td></td><td></td> </tr> </tbody> </table> <table border="1" style="width: 100%; border-collapse: collapse;"> <thead> <tr> <th rowspan="2"></th> <th colspan="16">To make program change</th> </tr> <tr> <th colspan="16">Jack number</th> </tr> <tr> <th></th> <th>17</th><th>18</th><th>19</th><th>20</th><th>21</th><th>22</th><th>23</th><th>24</th><th>25</th><th>26</th><th>27</th><th>28</th><th>29</th><th>30</th><th>31</th><th>32</th> </tr> </thead> <tbody> <tr> <td>Enable</td> <td></td><td></td><td></td><td></td><td></td><td></td><td></td><td></td><td></td><td></td><td></td><td></td><td></td><td></td><td></td><td></td> </tr> <tr> <td>Disable</td> <td></td><td></td><td></td><td></td><td></td><td></td><td></td><td></td><td></td><td></td><td></td><td></td><td></td><td></td><td></td><td></td> </tr> </tbody> </table>		Default	To make program change																Jack number																	all jack numbers	01	02	03	04	05	06	07	08	09	10	11	12	13	14	15	16	Enable																		Disable	x																		To make program change																Jack number																	17	18	19	20	21	22	23	24	25	26	27	28	29	30	31	32	Enable																	Disable																																																																																										
	Default	To make program change																																																																																																																																																																																																																																																						
		Jack number																																																																																																																																																																																																																																																						
	all jack numbers	01	02	03	04	05	06	07	08	09	10	11	12	13	14	15	16																																																																																																																																																																																																																																							
Enable																																																																																																																																																																																																																																																								
Disable	x																																																																																																																																																																																																																																																							
	To make program change																																																																																																																																																																																																																																																							
	Jack number																																																																																																																																																																																																																																																							
	17	18	19	20	21	22	23	24	25	26	27	28	29	30	31	32																																																																																																																																																																																																																																								
Enable																																																																																																																																																																																																																																																								
Disable																																																																																																																																																																																																																																																								
Ringing Assignment of Doorphone. Day Mode	70	<div style="text-align: center;"> </div> <table border="1" style="width: 100%; border-collapse: collapse; margin-bottom: 10px;"> <thead> <tr> <th rowspan="2"></th> <th rowspan="2">Default</th> <th colspan="16">To make program change</th> </tr> <tr> <th colspan="16">Jack number</th> </tr> <tr> <th></th> <th>all jack numbers</th> <th>01</th><th>02</th><th>03</th><th>04</th><th>05</th><th>06</th><th>07</th><th>08</th><th>09</th><th>10</th><th>11</th><th>12</th><th>13</th><th>14</th><th>15</th><th>16</th> </tr> </thead> <tbody> <tr> <td>Doorphone 1</td> <td>Enable</td> <td style="text-align: center;">x</td><td></td><td></td><td></td><td></td><td></td><td></td><td></td><td></td><td></td><td></td><td></td><td></td><td></td><td></td><td></td> </tr> <tr> <td></td> <td>Disable</td> <td></td><td></td><td></td><td></td><td></td><td></td><td></td><td></td><td></td><td></td><td></td><td></td><td></td><td></td><td></td><td></td> </tr> <tr> <td>Doorphone 2</td> <td>Enable</td> <td style="text-align: center;">x</td><td></td><td></td><td></td><td></td><td></td><td></td><td></td><td></td><td></td><td></td><td></td><td></td><td></td><td></td><td></td> </tr> <tr> <td></td> <td>Disable</td> <td></td><td></td><td></td><td></td><td></td><td></td><td></td><td></td><td></td><td></td><td></td><td></td><td></td><td></td><td></td><td></td> </tr> </tbody> </table> <table border="1" style="width: 100%; border-collapse: collapse;"> <thead> <tr> <th rowspan="2"></th> <th colspan="16">To make program change</th> </tr> <tr> <th colspan="16">Jack number</th> </tr> <tr> <th></th> <th>17</th><th>18</th><th>19</th><th>20</th><th>21</th><th>22</th><th>23</th><th>24</th><th>25</th><th>26</th><th>27</th><th>28</th><th>29</th><th>30</th><th>31</th><th>32</th> </tr> </thead> <tbody> <tr> <td>Doorphone 1</td> <td>Enable</td> <td></td><td></td><td></td><td></td><td></td><td></td><td></td><td></td><td></td><td></td><td></td><td></td><td></td><td></td><td></td><td></td> </tr> <tr> <td></td> <td>Disable</td> <td></td><td></td><td></td><td></td><td></td><td></td><td></td><td></td><td></td><td></td><td></td><td></td><td></td><td></td><td></td><td></td> </tr> <tr> <td>Doorphone 2</td> <td>Enable</td> <td></td><td></td><td></td><td></td><td></td><td></td><td></td><td></td><td></td><td></td><td></td><td></td><td></td><td></td><td></td><td></td> </tr> <tr> <td></td> <td>Disable</td> <td></td><td></td><td></td><td></td><td></td><td></td><td></td><td></td><td></td><td></td><td></td><td></td><td></td><td></td><td></td><td></td> </tr> </tbody> </table>		Default	To make program change																Jack number																	all jack numbers	01	02	03	04	05	06	07	08	09	10	11	12	13	14	15	16	Doorphone 1	Enable	x																	Disable																	Doorphone 2	Enable	x																	Disable																		To make program change																Jack number																	17	18	19	20	21	22	23	24	25	26	27	28	29	30	31	32	Doorphone 1	Enable																		Disable																	Doorphone 2	Enable																		Disable																
	Default	To make program change																																																																																																																																																																																																																																																						
		Jack number																																																																																																																																																																																																																																																						
	all jack numbers	01	02	03	04	05	06	07	08	09	10	11	12	13	14	15	16																																																																																																																																																																																																																																							
Doorphone 1	Enable	x																																																																																																																																																																																																																																																						
	Disable																																																																																																																																																																																																																																																							
Doorphone 2	Enable	x																																																																																																																																																																																																																																																						
	Disable																																																																																																																																																																																																																																																							
	To make program change																																																																																																																																																																																																																																																							
	Jack number																																																																																																																																																																																																																																																							
	17	18	19	20	21	22	23	24	25	26	27	28	29	30	31	32																																																																																																																																																																																																																																								
Doorphone 1	Enable																																																																																																																																																																																																																																																							
	Disable																																																																																																																																																																																																																																																							
Doorphone 2	Enable																																																																																																																																																																																																																																																							
	Disable																																																																																																																																																																																																																																																							

TO SET	PROGRAM ADDRESS	STEPS REQUIRED TO CHANGE PROGRAM																																																																																																																																																																																																																																																											
Ringing Assignment of Doorphone (cont.) Night Mode	71	<div style="text-align: center;"> <p>another doorphone number other jack number</p> <p>NEXT → SELECT MEMORY END</p> <p>..... Enable / Disable until the desired jack number (01 through 32) appears until the desired doorphone number (1 or 2) appears</p> </div> <table border="1" style="width: 100%; border-collapse: collapse; text-align: center;"> <thead> <tr> <th colspan="2" rowspan="2"></th> <th>Default</th> <th colspan="16">To make program change</th> </tr> <tr> <th>all jack numbers</th> <th colspan="16">Jack number</th> </tr> <tr> <th colspan="2"></th> <th></th> <th>01</th><th>02</th><th>03</th><th>04</th><th>05</th><th>06</th><th>07</th><th>08</th><th>09</th><th>10</th><th>11</th><th>12</th><th>13</th><th>14</th><th>15</th><th>16</th> </tr> </thead> <tbody> <tr> <td rowspan="2">Doorphone 1</td> <td>Enable</td> <td>x</td> <td></td><td></td><td></td><td></td><td></td><td></td><td></td><td></td><td></td><td></td><td></td><td></td><td></td><td></td><td></td><td></td> </tr> <tr> <td>Disable</td> <td></td> <td></td><td></td><td></td><td></td><td></td><td></td><td></td><td></td><td></td><td></td><td></td><td></td><td></td><td></td><td></td><td></td> </tr> <tr> <td rowspan="2">Doorphone 2</td> <td>Enable</td> <td>x</td> <td></td><td></td><td></td><td></td><td></td><td></td><td></td><td></td><td></td><td></td><td></td><td></td><td></td><td></td><td></td><td></td> </tr> <tr> <td>Disable</td> <td></td> <td></td><td></td><td></td><td></td><td></td><td></td><td></td><td></td><td></td><td></td><td></td><td></td><td></td><td></td><td></td><td></td> </tr> </tbody> </table> <table border="1" style="width: 100%; border-collapse: collapse; text-align: center;"> <thead> <tr> <th colspan="2" rowspan="2"></th> <th colspan="16">To make program change</th> </tr> <tr> <th colspan="16">Jack number</th> </tr> <tr> <th colspan="2"></th> <th>17</th><th>18</th><th>19</th><th>20</th><th>21</th><th>22</th><th>23</th><th>24</th><th>25</th><th>26</th><th>27</th><th>28</th><th>29</th><th>30</th><th>31</th><th>32</th> </tr> </thead> <tbody> <tr> <td rowspan="2">Doorphone 1</td> <td>Enable</td> <td></td><td></td><td></td><td></td><td></td><td></td><td></td><td></td><td></td><td></td><td></td><td></td><td></td><td></td><td></td><td></td> </tr> <tr> <td>Disable</td> <td></td><td></td><td></td><td></td><td></td><td></td><td></td><td></td><td></td><td></td><td></td><td></td><td></td><td></td><td></td><td></td> </tr> <tr> <td rowspan="2">Doorphone 2</td> <td>Enable</td> <td></td><td></td><td></td><td></td><td></td><td></td><td></td><td></td><td></td><td></td><td></td><td></td><td></td><td></td><td></td><td></td> </tr> <tr> <td>Disable</td> <td></td><td></td><td></td><td></td><td></td><td></td><td></td><td></td><td></td><td></td><td></td><td></td><td></td><td></td><td></td><td></td> </tr> </tbody> </table>			Default	To make program change																all jack numbers	Jack number																			01	02	03	04	05	06	07	08	09	10	11	12	13	14	15	16	Doorphone 1	Enable	x																	Disable																		Doorphone 2	Enable	x																	Disable																				To make program change																Jack number																		17	18	19	20	21	22	23	24	25	26	27	28	29	30	31	32	Doorphone 1	Enable																	Disable																	Doorphone 2	Enable																	Disable																
		Default			To make program change																																																																																																																																																																																																																																																								
		all jack numbers	Jack number																																																																																																																																																																																																																																																										
			01	02	03	04	05	06	07	08	09	10	11	12	13	14	15	16																																																																																																																																																																																																																																											
Doorphone 1	Enable	x																																																																																																																																																																																																																																																											
	Disable																																																																																																																																																																																																																																																												
Doorphone 2	Enable	x																																																																																																																																																																																																																																																											
	Disable																																																																																																																																																																																																																																																												
		To make program change																																																																																																																																																																																																																																																											
		Jack number																																																																																																																																																																																																																																																											
		17	18	19	20	21	22	23	24	25	26	27	28	29	30	31	32																																																																																																																																																																																																																																												
Doorphone 1	Enable																																																																																																																																																																																																																																																												
	Disable																																																																																																																																																																																																																																																												
Doorphone 2	Enable																																																																																																																																																																																																																																																												
	Disable																																																																																																																																																																																																																																																												
Call on Hold for Standard Telephone	91	<div style="text-align: center;"> <p>SELECT MEMORY END</p> <p>..... Hold-1/Hold-2</p> </div> <table border="1" style="width: 100%; border-collapse: collapse; text-align: center;"> <thead> <tr> <th colspan="2"></th> <th>Default</th> <th>To make program change</th> </tr> </thead> <tbody> <tr> <td>Hold-1</td> <td></td> <td>x</td> <td></td> </tr> <tr> <td>Hold-2</td> <td></td> <td></td> <td></td> </tr> </tbody> </table>			Default	To make program change	Hold-1		x		Hold-2																																																																																																																																																																																																																																																		
		Default	To make program change																																																																																																																																																																																																																																																										
Hold-1		x																																																																																																																																																																																																																																																											
Hold-2																																																																																																																																																																																																																																																													
System Data Clear	99	<ul style="list-style-type: none"> ● All Parameters ● System Parameter ● Speed Dial <div style="text-align: center;"> <p>SELECT MEMORY END</p> <p>..... All Para / System Para / CO Para / EXT Para / DSS Para / Speed Dial</p> </div> <ul style="list-style-type: none"> ● CO Parameter <div style="text-align: center;"> <p>SELECT MEMORY AB MEMORY END</p> <p>..... dial CO number (01 through 12) until the CO Para appears</p> </div> <ul style="list-style-type: none"> ● Extension Parameter <div style="text-align: center;"> <p>SELECT MEMORY AB MEMORY END</p> <p>..... dial jack number (01 through 32) until the EXT Para appears</p> </div> <ul style="list-style-type: none"> ● DSS Parameter <div style="text-align: center;"> <p>SELECT MEMORY A MEMORY END</p> <p>..... dial DSS number (1 or 2) until the DSS Para appears</p> </div>																																																																																																																																																																																																																																																											